

Gateway EC14D Series Service Guide

Service guide files and updates are available on the ACER/CSD web; for more information, please refer to <http://csd.acer.com.tw>

PRINTED IN TAIWAN

Revision History

Please refer to the table below for the updates made to this service guide.

Date	Chapter	Updates

Copyright

Copyright © 2009 by Acer Incorporated. All rights reserved. No part of this publication may be reproduced, transmitted, transcribed, stored in a retrieval system, or translated into any language or computer language, in any form or by any means, electronic, mechanical, magnetic, optical, chemical, manual or otherwise, without the prior written permission of Acer Incorporated and others.

Disclaimer

The information in this guide is subject to change without notice.

Acer Incorporated makes no representations or warranties, either expressed or implied, with respect to the contents hereof and specifically disclaims any warranties of merchantability or fitness for any particular purpose. Any Acer Incorporated software described in this manual is sold or licensed "as is". Should the programs prove defective following their purchase, the buyer (and not Acer Incorporated, its distributor, or its dealer) assumes the entire cost of all necessary servicing, repair, and any incidental or consequential damages resulting from any defect in the software.

Acer is a registered trademark of Acer Corporation.

Intel is a registered trademark of Intel Corporation.

Other brand and product names are trademarks and/or registered trademarks of their respective holders.

Conventions

The following conventions are used in this manual:

SCREEN MESSAGES	Denotes actual messages that appear on screen.
NOTE	Gives bits and pieces of additional information related to the current topic.
WARNING	Alerts you to any damage that might result from doing or not doing specific actions.
CAUTION	Gives precautionary measures to avoid possible hardware or software problems.
IMPORTANT	Reminds you to do specific actions relevant to the accomplishment of procedures.

Preface

Before using this information and the product it supports, please read the following general information.

1. This Service Guide provides you with all technical information relating to the BASIC CONFIGURATION decided for Acer's "global" product offering. To better fit local market requirements and enhance product competitiveness, your regional office MAY have decided to extend the functionality of a machine (e.g. add-on card, modem, or extra memory capability). These LOCALIZED FEATURES will NOT be covered in this generic service guide. In such cases, please contact your regional offices or the responsible personnel/channel to provide you with further technical details.
2. Please note WHEN ORDERING FRU PARTS, that you should check the most up-to-date information available on your regional web or channel. If, for whatever reason, a part number change is made, it will not be noted in the printed Service Guide. For ACER-AUTHORIZED SERVICE PROVIDERS, your Acer office may have a DIFFERENT part number code to those given in the FRU list of this printed Service Guide. You MUST use the list provided by your regional Acer office to order FRU parts for repair and service of customer machines.

System Specifications	1
Features	1
Operating System	1
Platform	1
System Memory	1
Display	1
Graphics	1
Storage Subsystem	2
Optical Media Drive	2
Audio	2
I/O Interface	2
Dimensions and Weight	2
Communication	3
Privacy Control	3
Power Subsystem	3
Special Keys and Controls	3
Environment	4
System Block Diagram	5
Front View	6
Left View	6
Right View	7
Bottom View	8
Keyboard Area and LCD Panel	9
Touchpad Basics	11
Using the Keyboard	12
Lock Keys and Embedded Numeric Keypad	12
Windows Keys	13
Function Keys	14
Hardware Specifications and Configurations	15
 System Utilities	 19
BIOS Setup Utility	19
Navigating the BIOS Utility	19
Information	20
Main	21
Security	22
Boot	25
Exit	26
BIOS Flash Utility	27
DOS Flash Utility	28
WinFlash Utility	30
Remove HDD/BIOS Password Utilities	31
Miscellaneous Utilities	33
 Machine Disassembly and Replacement	 37
Disassembly Requirements	37
General Information	38
Pre-disassembly Instructions	38
Disassembly Process	38
External Module Disassembly Process	39
External Modules Disassembly Flowchart	39
Removing the Battery Pack	40
Removing the SD Dummy Card	41
Removing the DIMM Module	42

Table of Contents

Removing the HDD Module	43
Removing the WLAN Module	46
Removing the ODD Module	48
Main Unit Disassembly Process	51
Main Unit Disassembly Flowchart	51
Removing the Keyboard	52
Removing the Upper Cover	54
Removing the LED Board	58
Removing the Card Reader Board	60
Removing the Button Board	62
Removing the Bluetooth Module	63
Removing the Mainboard	65
Removing the Thermal Module	68
Removing the I/O Board	69
Removing the Speaker Module	70
Removing the Function Board	72
Removing the LCD Module	73
Removing the VGA Cable	75
Removing the DC Jack	76
LCD Module Disassembly Process	77
LCD Module Disassembly Flowchart	77
Removing the LCD Bezel	78
Removing the Camera Module	79
Removing the LCD Panel	80
Removing the LCD Brackets	81
Removing the LVDS/Microphone Cable	81
Removing the WLAN Antennas	82
LCD Module Reassembly Procedure	84
Replacing the WLAN Antennas	84
Replacing the LCD/Microphone Cable	85
Replacing the LCD Panel	85
Replacing the Camera Module	87
Replacing the LCD Bezel	88
Main Module Reassembly Procedure	90
Replacing the DC Jack	90
Replacing the VGA Cable	91
Replacing the LCD Module	92
Replacing the Wi-Fi Switch Board	93
Replacing the Speakers	95
Replacing the I/O Board	96
Replacing the Thermal Module	97
Replacing the Mainboard	99
Replacing the Bluetooth Module	102
Replacing the Button Board	104
Replacing the Card Reader Board	105
Replacing the LED Board	107
Replacing the Upper Cover	108
Replacing the Keyboard	112
Replacing the ODD	113
Replacing the WLAN Module	115
Replacing the Hard Disk Drive	116
Replacing the DIMM Modules	118
Replacing the Lower Covers	118
Replacing the Battery	120
Replacing the SD Dummy Card	120

Table of Contents

Troubleshooting	121
Common Problems	121
Power On Issue	122
Computer Shutdown Intermittently	122
No Display Issue	123
No POST or Video	123
Abnormal Video Display	124
Random Loss of BIOS Settings	124
LCD Failure	125
Built-In Keyboard Failure	125
TouchPad Failure	126
Internal Speaker Failure	126
Sound Problems	127
Internal Microphone Failure	128
Microphone Problems	128
HDD Not Operating Correctly	129
USB Failure	130
Wireless Function Failure	130
Thermal Unit Failure	131
External Mouse Failure	131
Other Failures	132
Intermittent Problems	132
Undetermined Problems	132
Post Codes	133
Jumper and Connector Locations	141
Mainboard Description	141
Top View	141
Bottom View	142
Clearing Password Check and BIOS Recovery	143
Clearing Password Check	143
Steps for Clearing BIOS Password Check	143
BIOS Recovery by Crisis Disk	145
FRU (Field Replaceable Unit) List	147
Exploded Diagrams	147
Main Assembly	147
LCD Assembly	147
FRU List	148
Screw List	158
Model Definition and Configuration	160
Test Compatible Components	163
Online Support Information	167
Index	169

Table of Contents

System Specifications

Features

Below is a brief summary of the computer's many features:

Operating System

- Genuine Windows® 7 Home Premium 64-bit
- Genuine Windows® 7 Home Basic 64 bit

Platform

- **Intel® Pentium®** processor **SU4100** (2 MB L2 cache, 1.30 GHz, 800 MHz FSB, 10 W), supporting Intel® 64 architecture
- **Intel® Celeron®** processor **SU2300** (1 MB L2 cache, 1.20 GHz, 800 MHz FSB, 10 W), supporting Intel® 64 architecture
- **Intel® Celeron®** processor **743** (1 MB L2 cache, 1.30 GHz, 800 MHz FSB, 10 W), supporting Intel® 64 architecture
- Mobile Intel® GS45 Express Chipset

System Memory

- Dual-channel DDR3 SDRAM support:
 - Up to 4 GB of DDR3 1066 MHz memory, upgradeable to 8 GB using two soDIMM modules (for 64-bit OS)

Display

- 11.6" HD 1366 x 768 or SD 1024 x 600 pixel resolution, high-brightness (200-nit) Gateway Ultrabright™ TFT LCD
- 16:9 aspect ratio

Graphics

- Mobile Intel® GS45 Express Chipset with integrated 3D graphics, featuring Intel® Graphics Media Accelerator 4500MHD (Intel® GMA 4500MHD) with up to 1759 MB of Intel® Dynamic Video Memory Technology 5.0 (64 MB of dedicated system memory, up to 1695 MB of shared system memory), supporting Microsoft® DirectX® 10
- Dual independent display support
- 16.7 million colors
- External resolution / refresh rate:
 - VGA port up to 2048 x 1536: 60 Hz
 - HDMI™ port up to 1728 x 1080: 60 Hz

-
- MPEG-2/DVD decoding
 - WMV9 (VC-1) and H.264 (AVC) decoding
 - HDMI™ (High-Definition Multimedia Interface) with HDCP (High-bandwidth Digital Content Protection) support

Storage Subsystem

- 2.5" 9.5 mm 160/250/320 GB or higher hard disk drive
- Multi-in-1 card reader:
 - Supporting Secure Digital™ (SD) Card, MultiMediaCard (MMC), Memory Stick™ (MS), Memory Stick PRO™ (MS PRO), xD-Picture Card™ (xD)
 - Supporting storage cards with adapter: miniSD™, microSD™, Memory Stick Duo™, Reduced-Size Multimedia Card (RS-MMC), Memory Stick PRO Duo™

Optical Media Drive

- 8X DVD-Super Multi double-layer drive:
 - Read: 24X CD-ROM, 24X CD-R, 24X CD-RW, 8X DVD-ROM, 8X DVD-R, 8X DVD+R, 6X DVD-ROM DL, 6X DVD-R DL, 6X DVD+R DL, 6X DVD-RW, 6X DVD+RW, 5X DVD-RAM
 - Write: 24X CD-R, 16X CD-RW, 8X DVD-R, 8X DVD+R, 4X DVD-R DL, 4X DVD+R DL, 6X DVD-RW, 8X DVD+RW, 5X DVD-RAM

Audio

- High-definition audio support
- Two built-in stereo speakers
- S/PDIF (Sony/Philips Digital Interface) support for digital speakers
- MS-Sound compatible
- Built-in microphone

I/O Interface

- Multi-in-1 card reader
- Three USB 2.0 ports
- HDMI™ port with HDCP support
- External display (VGA) port
- Headphone/speaker/line-out jack with S/PDIF support
- Microphone-in jack
- Ethernet (RJ-45) port
- DC-in jack for AC adapter

Dimensions and Weight

- 292 (W) x 211.5 (D) x 28.5/30 (H) mm
- 1.61 kg

Communication

- Video conferencing solution, featuring:
 - Webcam with 640 x 480 resolution
 - Microphone
- WLAN:
 - Intel® WiFi Link 1000 802.11b/g/n Wi-Fi CERTIFIED™
 - Featuring MIMO technology (for models with Intel® Celeron® 743 and Pentium® SU4100 only)
- WLAN:
 - 802.11b/g/n Wi-Fi CERTIFIED
 - 802.11b/g Wi-Fi CERTIFIED (available only in Russia, Pakistan, Ukraine)
- WPAN: Bluetooth® 2.1+EDR
- WWAN: UMTS/HSPA at 850/900/1900/2100 MHz and quad-band GSM/GPRS/EDGE (850/900/1800/1900 MHz), upgradeable to 7.2 Mb/s HSDPA and 5.7 Mb/s HSUPA, supporting receiver diversity and equalizing at 2100 MHz (for 3G models)
- LAN: Gigabit Ethernet, Wake-on-LAN ready

Privacy Control

- BIOS user, supervisor, HDD passwords
- Kensington lock slot

Power Subsystem

- ACPI 3.0 CPU power management standard: supports Standby and Hibernation power-saving modes
- 62.16 W 5600 mAh 6-cell Li-ion battery pack:
 - 8-hour battery life
- 47.52 W 4400 mAh 6-cell Li-ion battery pack:
 - 6-hour battery life
- 30 W AC adapter
- ENERGY STAR®

Special Keys and Controls

- 84-/85-/88-key full size keyboard, with inverted "T" cursor layout
- Multi-gesture touchpad, supporting two-finger scroll, pinch, rotate, flip
- 10 function keys, four cursor keys, two Windows® keys, hotkey controls, embedded numeric keypad, international language support
- Power button with LED
- Easy-access switches with LED: Bluetooth®, WLAN/WWAN

Environment

- Temperature:
 - Operating: TBD
 - Non-operating: TBD
- Humidity (non-condensing):
 - Operating: TBD
 - Non-operating: TBD

System Block Diagram

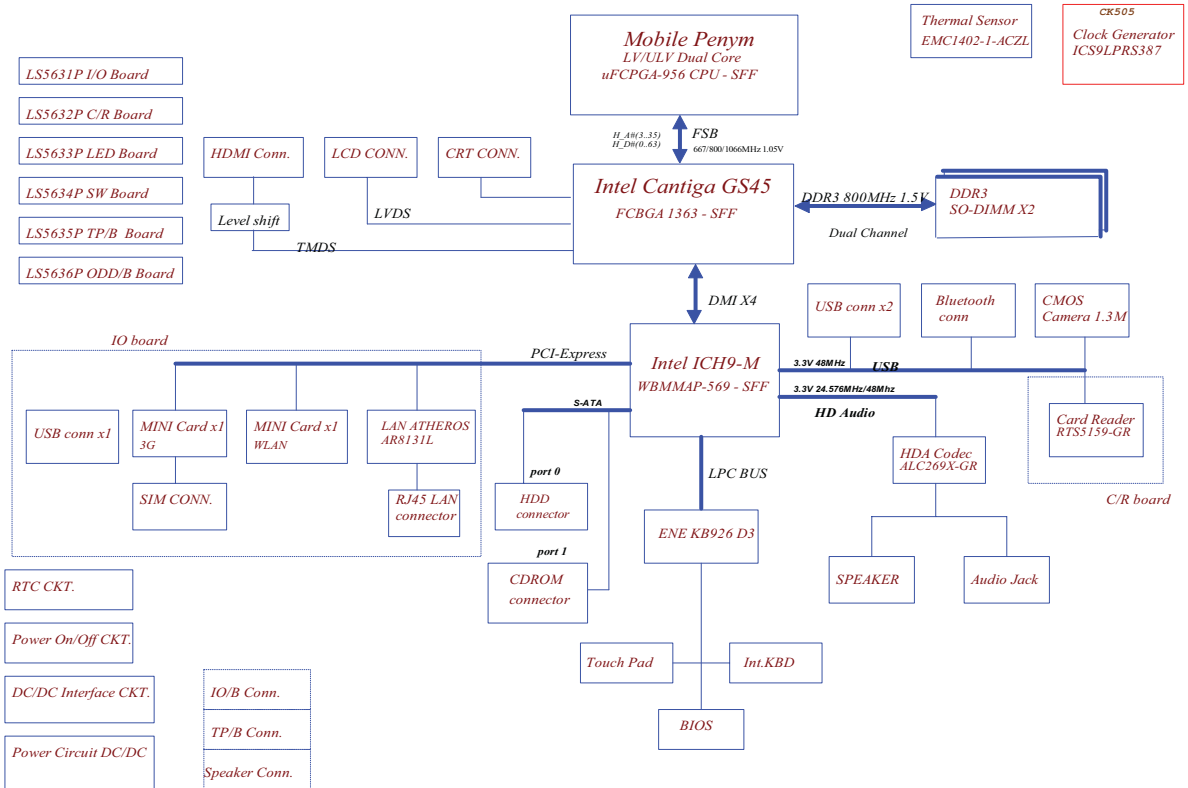







Front View



#	Component	Icon	Description
1	Status Indicators		Light-Emitting Diodes (LED) that light up to show the status of the computer's functions and components.



Left View



#	Component	Icon	Description
1	DC-in jack		Connects to an AC adapter.
2	External display (VGA) port		Connects to a display device (e.g., external monitor, LCD projector).
3	Ventilation slots and/or cooling fan		Enables the computer to stay cool, even after prolonged use. Note: Do not cover or obstruct the opening of the fan.
4	HDMI port	HDMI	HDMI Plug an HDMI device, such as a high definition television, into this optional jack.
5	USB 2.0 ports (2)		Connects to USB 2.0 devices (e.g., USB mouse).
6	Microphone-in jack		Accepts input from external microphones.
7	Headphone/speaker/line-out jack		Connects to line-out audio devices (e.g., speakers, headphones).
8	Kensington lock slot		Connects to a Kensington-compatible computer security lock.



Right View

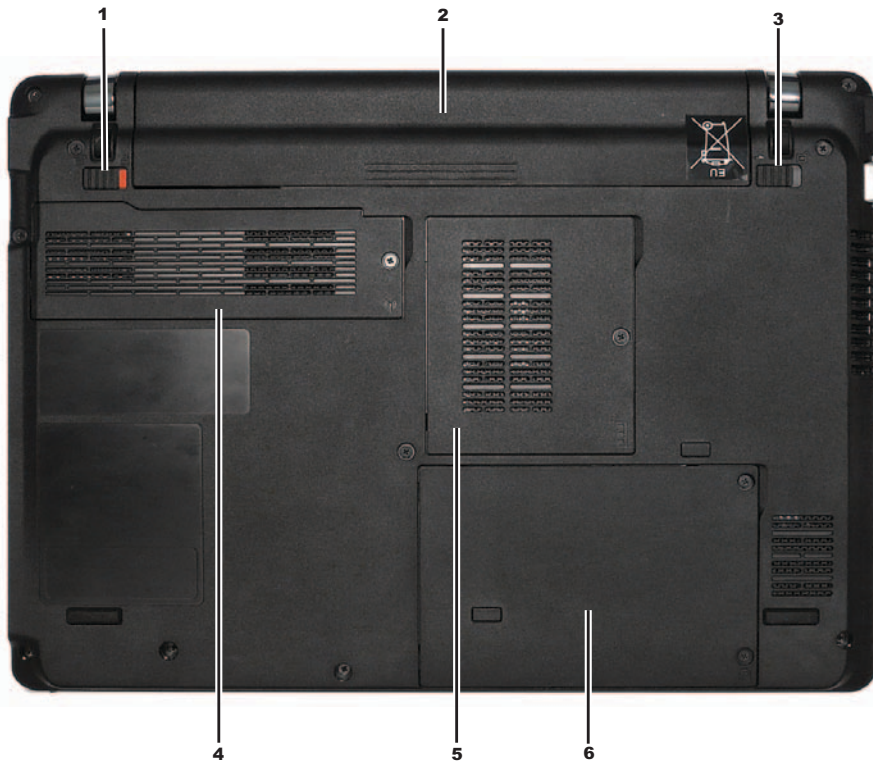

#	Component	Icon	Description
1	Multi-in-1 card reader		Accepts Secure Digital (SD), MultiMediaCard (MMC), Memory Stick (MS), Memory Stick PRO (MS PRO), xD-Picture Card (xD). Note: Push to remove/install the card. Only one card can operate at any given time.
2	ODD		
3	USB 2.0 port		Connects to USB 2.0 devices (e.g., USB mouse).
4	Ethernet (RJ-45) port		Connects to an Ethernet 10/100-based network.

Bottom View







#	Component	Icon	Description
1	Battery lock		Locks the battery in position.
2	Battery bay		Houses the computer's battery pack. Note: The battery shown is for reference only. Your PC may have a different battery, depending on the model purchased.
3	Battery release latch		Releases the battery for removal.
4	Wireless LAN communication bay		Houses the computer's Wireless LAN communication.
5	Memory compartment		Houses the computer's main memory
6	Hard Drive Bay		Houses the computer's hard disk drive.

Keyboard Area and LCD Panel



No.	Component	Icon	Description
1	Webcam		Web camera for video communication
2	Microphone		Internal microphone for sound recording.
3	Display screen		Also called Liquid-Crystal Display (LCD). Displays computer output.
4	HDD indicator		Indicates when the hard disk drive is active.
	Num Lock indicator		Lights up when Num Lock is activated.
	Caps Lock indicator		Lights up when Caps Lock is activated.

No.	Component	Icon	Description
5	Keyboard		Provides all the features of a full-sized, computer keyboard.
6	Touchpad		Touch-sensitive pointing device which functions like a computer mouse.
7	Click buttons (left, and right)		The left and right buttons function like the left and right mouse buttons.
8	Power button/indicator		Turns the computer on and indicates the computer's power status.
9	Bluetooth communication indicator 3G/Wireless LAN communication indicator		Indicates the status of the Bluetooth communication. (only for certain models) Indicates the status of 3G/Wireless LAN communication: Blue light on — 3G on / WiFi on or off Orange light on — 3G off / WiFi on Not lit — 3G off / WiFi off
	Power indicator		Indicates when the computer is turned on.
	Battery indicator		Indicates the computer's battery status.
	Wi-Fi		Indicates the computer's Wi-Fi status.

Touchpad Basics

The following items show you how to use the TouchPad:

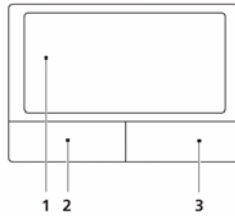

- Move your finger across the TouchPad (1) to move the cursor.
- Press the left (2) and right (3) buttons located beneath the TouchPad to perform selection and execution functions. These two buttons are similar to the left and right buttons on a mouse. Tapping on the TouchPad is the same as clicking the left button.

Function	Left Button (2)	Right Button (3)	Main TouchPad (1)
Execute	Quickly click twice.		Tap twice (at the same speed as double-clicking a mouse button).
Select	Click once.		Tap once.
Drag	Click and hold, then use finger on the TouchPad to drag the cursor.		Tap twice (at the same speed as double-clicking a mouse button); rest your finger on the TouchPad on the second tap and drag the cursor.
Access context menu		Click once.	

NOTE: When using the TouchPad, keep it - and your fingers - dry and clean. The TouchPad is sensitive to finger movement; hence, the lighter the touch, the better the response. Tapping too hard will not increase the TouchPad's responsiveness.

Using the Keyboard

Your Gateway EC14D has a close-to-full-sized keyboard and an embedded numeric keypad, separate cursor, lock, function and special keys.

Lock Keys and Embedded Numeric Keypad

The keyboard has three lock keys which you can toggle on and off.

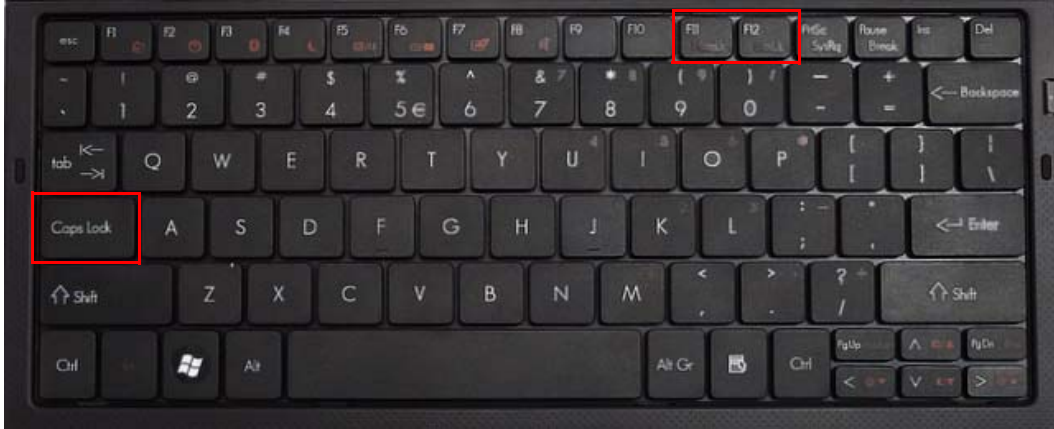



















Lock key	Description
Caps Lock	When Caps Lock is on, all alphabetic characters typed are in uppercase.
Num Lock <Fn> + <F11>	When Num Lock is on, the embedded keypad is in numeric mode. The keys function as a calculator (complete with the arithmetic operators +, -, *, and /). Use this mode when you need to do a lot of numeric data entry. A better solution would be to connect an external keypad.
Scroll Lock <Fn> + <F12>	When Scroll Lock is on, the screen moves one line up or down when you press the up or down arrow keys respectively. Scroll Lock does not work with some applications.

The embedded numeric keypad functions like a desktop numeric keypad. It is indicated by small characters located on the upper right corner of the keycaps. To simplify the keyboard legend, cursor-control key symbols are not printed on the keys.

Desired access	Num Lock on	Num Lock off
Number keys on embedded keypad	Type numbers in a normal manner.	
Main keyboard keys	Hold <Fn> while typing letters on embedded keypad.	Type the letters in a normal manner.

Windows Keys

The keyboard has two keys that perform Windows-specific functions.





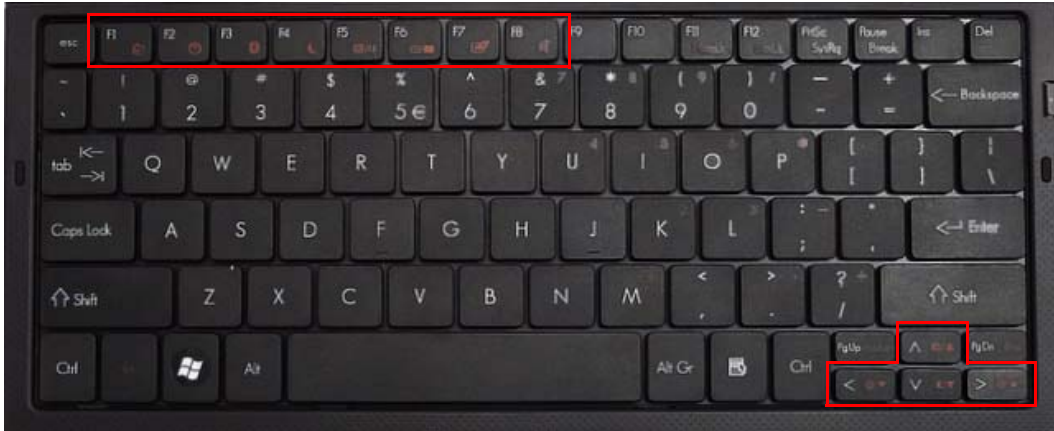





Key	Description
 Windows key	<p>Pressed alone, this key has the same effect as clicking on the Windows Start button; it launches the Start menu. It can also be used with other keys to provide a variety of functions:</p> <ul style="list-style-type: none"><  >: Open or close the Start menu<  > + <D>: Display the desktop<  > + <E>: Open Windows Explore<  > + <F>: Search for a file or folder<  > + <G>: Cycle through Sidebar gadgets<  > + <L>: Lock your computer (if you are connected to a network domain), or switch users (if you're not connected to a network domain)<  > + <M>: Minimizes all windows<  > + <R>: Open the Run dialog box<  > + <T>: Cycle through programs on the taskbar<  > + <U>: Open Ease of Access Center<  > + <X>: Open Windows Mobility Center<  > + <BREAK>: Display the System Properties dialog box<  > + <SHIFT+M>: Restore minimized windows to the desktop<  > + <TAB>: Cycle through programs on the taskbar by using Windows Flip 3-D<  > + <SPACEBAR>: Bring all gadgets to the front and select Windows Sidebar<CTRL> + <  > + <F>: Search for computers (if you are on a network)<CTRL> + <  > + <TAB>: Use the arrow keys to cycle through programs on the taskbar by using Windows Flip 3-D <p>Note: Depending on your edition of Windows 7, some shortcuts may not function as described.</p>
 Application key	This key has the same effect as clicking the right mouse button; it opens the application's context menu.

Function Keys



The computer employs hotkeys or key combinations to access most of the computer's controls like screen brightness, Bluetooth and WiFi.

To activate hot keys, press and hold the <Fn> key before pressing the other key in the hotkey combination.

Function Key		Description
<Fn> + <F1>	*	Change Power Options
<Fn> + <F2>	*	View System Properties
<Fn> + <F3>		Turn the Bluetooth radio on or off.
<Fn> + <F4>		Sleep
<Fn> + <F5>		Display toggle
<Fn> + <F6>		Screen blank (backlight off)
<Fn> + <F7>		TouchPad toggle
<Fn> + <F8>		Speaker toggle
<Fn> + <D>		Brightness up
<Fn> + <D>		Brightness down
<Fn> + <A>		Volume up
<Fn> + <A>		Volume down

Hardware Specifications and Configurations

Processor

Item	Specification
CPU	<ul style="list-style-type: none"> Ultra Low Voltage (ULV) Intel® Core™2 Duo mobile processor based on 45 nm process, supporting Intel® 64 architecture Ultra Low Voltage (ULV) Intel® Celeron® processor based on 45 nm process, supporting Intel® 64 architecture Micro FCBGA-956 package
Core Logic	<ul style="list-style-type: none"> AMD M880G Chipset

Processor Specifications

Item	CPU Speed	Cores	Mfg. Tech	cache Size	Package	Power	Acer P/N
Pentium SU4100	1.3	2		2MB	100C 22x22mm	10W	KC.41B01.DSU
Celeron SU2300	1.2	1		1MB	100C 22x22mm	10W	KC.23B01.CSU
Celeron 743	1.3	1		1MB	100C 22x22mm	10W	KC.NB001.743

CPU Fan True Value Table

Fan On Temp (°C)	Fan Speed (rpm)	SPL Spec (dBA)
45	3900	28
55	4300	31
65	4700	34
80	5300	37
87	5300	37

- Throttling 50%: On=95°C, Off=87°C
- EC Shutdown: 100°C

BIOS

Item	Specification
BIOS vendor	InsydeH20
BIOS Version	3.0

System Memory

Item	Specification
Memory controller	Intel GS45 Express chipset Graphics Memory Controller Hub/ ICH9M-SFF
Memory size	0MB (onboard)
DIMM socket number	2
Supports memory size per socket	2048MB
Supports maximum memory size	4096MB
Supports DIMM type	204-pin DDRII SO-DIMM
Supports DIMM Speed	TBD
Supports DIMM voltage	1.5v

Graphics Controller

Item	Specification
VGA Chip	Mobile Intel® GS45 Express Chipset with integrated 3D graphics, featuring Intel® Graphics Media Accelerator 4500MHD (Intel® GMA 4500MHD) with up to 1759 MB of Intel® Dynamic Video Memory Technology 5.0 (64 MB of dedicated system memory, up to 1695 MB of shared system memory), supporting Microsoft® DirectX® 10
Supports	<ul style="list-style-type: none"> • Dual independent display support • 16.7 million colors • External resolution / refresh rate: <ul style="list-style-type: none"> • VGA port up to 2048 x 1536: 60 Hz • HDMI™ port up to 1728 x 1080: 60 Hz • MPEG-2/DVD decoding • WMV9 (VC-1) and H.264 (AVC) decoding • HDMI™ (High-Definition Multimedia Interface) with HDCP (High-bandwidth Digital Content Protection) support
Resolution	<ul style="list-style-type: none"> • 1366 x 768

LAN Interface

Item	Specification
LAN Chipset	Atheros AR8131L LAN Controller for 10/100/1000LAN
LAN connector type	RJ-45
LAN connector location	Right side
Features	Support for 10/100

Hard Disk Drive Interface

Item	Specification	
Vendor	Seagate	
Model Name	ST9160310AS	ST9320320AS
Capacity (MB)	160	250, 320
Bytes per sector	512	
Data heads	2	4
Drive Format		
Disks	1	2
Spindle speed (RPM)	5,400	
Performance Specifications		
Buffer size	8 MB	
Interface	SATA	
Internal transfer rate (Mbits/sec max)	830	
I/O data transfer rate (Mbytes/sec max)	300	
DC Power Requirements		
Voltage tolerance	5V(DC) +/- 5%	

Audio Interface

Item	Specification
Audio Controller	Realtek ALC269X-GR for High Definition Audio Codec
<ul style="list-style-type: none"> • Features 	<ul style="list-style-type: none"> • 98dB Signal-to-Noise Ratio (A-weighting) for DAC/ADC output • Meets WLP (Windows Logo Program) 3.10 and future WLP requirements • 2+2-channel DAC supports 16/20/24-bit PCM format for independent two stereo channel audio playback • 4-channel ADC supports 16/20/24-bit PCM format for independent two stereo channel audio inputs • All DACs supports 44.1/48/96/192kHz sample rate • All ADCs support 44.1/48/96kHz sample rate • SPDIF-OUT support 16/20/24-bit format and 32/44.1/48/88.2/96/192kHz rate • Supports MONO line level output • Supports external PCBEEP input and built-in digital BEEP generator • Software selectable 2.5V/3.2V/4.2V VREFOUT as bias voltage for analog microphone input • Two jack detection pins each designed to detect up to 4 jacks • 1dB resolution of input and output volume control • Programmable +10/+20/+30dB boost gain for analog microphone input • Built-in headphone amplifiers for port-A and port-C. • 2 GPIOs are supported for customized applications (pin shared with digital microphone interface) • EAPD (External Amplifier Power Down) is supported (pin shared with secondary SPDIF-OUT) • Supports Anti-pop mode when analog power AVDD is on and digital power is off • Power support: 3.3V digital core power; 1.5V~3.3V digital IO power for HDA link; 3.3V~5.0V analog power; 3.3V~5.0V power stage voltage • Enhanced power management features • Secondary SPDIF-OUT supports 16/20/24-bit format and 32k/44.1k/48k/88.2k/96k/192kHz rate • Supports stereo digital microphone input • Programmable boost gain and volume control for digital microphone input • Headphone amplifier for port-A does not require DC blocking capacitors • Stereo Bridge-Tied Load Class-D amplifier at port-D has 2Watt (rms)/4? per channel output • Short circuit and thermal overload protection for Class D amplifier • Supports digital PWM output at port-D which system integrator can easily connect the output to external power amplifier receives digital audio stream • Five band hardware equalizer designed for BTL output (port-D) to compensate for frequency response while driving the mini-speaker • Intel low power ECR compliant: supports power status control, jack detection, and wake-up event in D3 mode • 48-pin QFN 'Green' package

Power and Keyboard Controller

Item	Specification
Controller	ENE KB926 for Keyboard Controller, Battery management Unit
Total number of keypads	84/85/88
Windows logo key	Yes
Internal & external keyboard work simultaneously	Yes
Features	<ul style="list-style-type: none"> Support Application keys for Windows 7

Battery

Item	Specification		
	3 Cell	6 Cell 2.2	6 Cell 2.8
Vendor & model name	SIMPLO UM09G75	SIMPLO UM09H75	SIMPLO UM09H70
Battery Type	Li-ion	Li-ion	Li-ion
Pack capacity	2200 mAh	4400 mAh	5600 mAh
Normal Voltage	11.1V	11.1V	11.1
Charge Voltage	12.6V	12.6V	12.6
Fast Charge Current	2.94~3.5A	2.94~3.5A	2.94~3.5A
Package configuration	3S2P	3S2P	3S2P

LCD

Item	Specification			
Vendor/model name	AUO B101AW03	CMO N101L6-L02	Innolux BT101IW01	LPL/Samsung LP101WSA- TLA1
Screen Diagonal (mm)	255.481			
Display Area (mm)	222.7 x 125.2			
Display resolution (pixels)	1024x600			
Pixel Pitch	0.218 x 0.209			
Typical White Luminance (cd/m ²) (also called Brightness)	200			
Contrast Ratio	400:1	500:1	500:1	
Response Time (Optical Rise Time/Fall Time) msec	16	10		
Typical Power Consumption (watt)	2.8	2.2		2.55
Weight (g)	190	170	190	
Physical Size (mm)	235 x 143 x 5.2			

System Utilities

BIOS Setup Utility

The BIOS Setup Utility is a hardware configuration program built into your computer's BIOS (Basic Input/Output System).

Your computer is already properly configured and optimized, and you do not need to run this utility. However, if you encounter configuration problems, you may need to run Setup. Please also refer to Chapter 4 Troubleshooting when problem arises.

To activate the BIOS Utility, press **F2** during POST (when **Press <F2> to enter Setup** message is prompted on the bottom of screen).

Press **F2** to enter setup. The default parameter of F12 Boot Menu is set to "disabled". If you want to change boot device without entering BIOS Setup Utility, please set the parameter to "enabled".

Press **<F12>** during POST to enter multi-boot menu. In this menu, user can change boot device without entering BIOS SETUP Utility.

Navigating the BIOS Utility

There are six menu options: Information, Main, Advanced, Security, Power, Boot, and Exit.

Follow these instructions:

- To choose a menu, use the left and right arrow keys.
- To choose an item, use the up and down arrow keys.
- To change the value of a parameter, press **F5** or **F6**.
- A plus sign (+) indicates the item has sub-items. Press **Enter** to expand this item.
- Press **Esc** while you are in any of the menu options to go to the Exit menu.
- In any menu, you can load default settings by pressing **F9**. You can also press **F10** to save any changes made and exit the BIOS Setup Utility.

NOTE: You can change the value of a parameter if it is enclosed in square brackets. Navigation keys for a particular menu are shown on the bottom of the screen. Help for parameters are found in the Item Specific Help part of the screen. Read this carefully when making changes to parameter values. **Please note that system information is subject to different models.**

Information

The Information screen displays a summary of your computer hardware information.

InsydeH20 Setup Utility
Rev. 3.0

Information
Main Security Boot Exit

```

CPU Type           Intel(R) Core(TM)2 Duo CPU T7300
CPU Speed          2.00GHz

HDD Model Name:    ST960821A-(PM)
HDD Serial Number: 3LF005DB
ATAPI Model Name:  MATSHITADVD

System BIOS Version: V1.00
VGA BIOS Version:  ATI V008.0501.0-26.00

Serial Number:     xxxxxxxxxxxxxxxxxxxxxx
Asset Tag Number:  xxxxxxxxxxxxxxxxxxxxxx
Product Name:      DOTS
Manufacturer Name: Packard Bell
UUID:              xxxxxxxxxxxxxxxxxxxxxx
                
```

F1 Help
↑↓ Select Item
F5/F6 Change Values
F9 Setup Default
ESC Exit
← Select Menu
Enter Select ► SubMenu
F10 Save and Exit

NOTE: The system information is subject to different models.

Parameter	Description
CPU Type	This field shows the CPU type and speed of the system.
CPU Speed	This field shows the speed of the CPU.
HDD Model Name	This field shows the model name of HDD installed on primary IDE master.
HDD Serial Number	This field displays the serial number of HDD installed on primary IDE master.
ATAPI Model Name	This field displays the ATAPI Model Name.
System BIOS Version	This field displays the system BIOS version.
VGA BIOS Version	This field displays the VGA firmware version of the system.
Serial Number	This field displays the serial number of this unit.
Asset Tag Number	This field displays the asset tag number of the system.
Product Name	This field shows product name of the system.
Manufacturer Name	This field displays the manufacturer of this system.
UUID	Universally Unique Identifier (UUID) is an identifier standard used in software construction, standardized by the Open Software Foundation (OSF) as part of the Distributed Computing Environment (DCE).

Main

The Main screen allows the user to set the system time and date as well as enable and disable boot option and recovery.

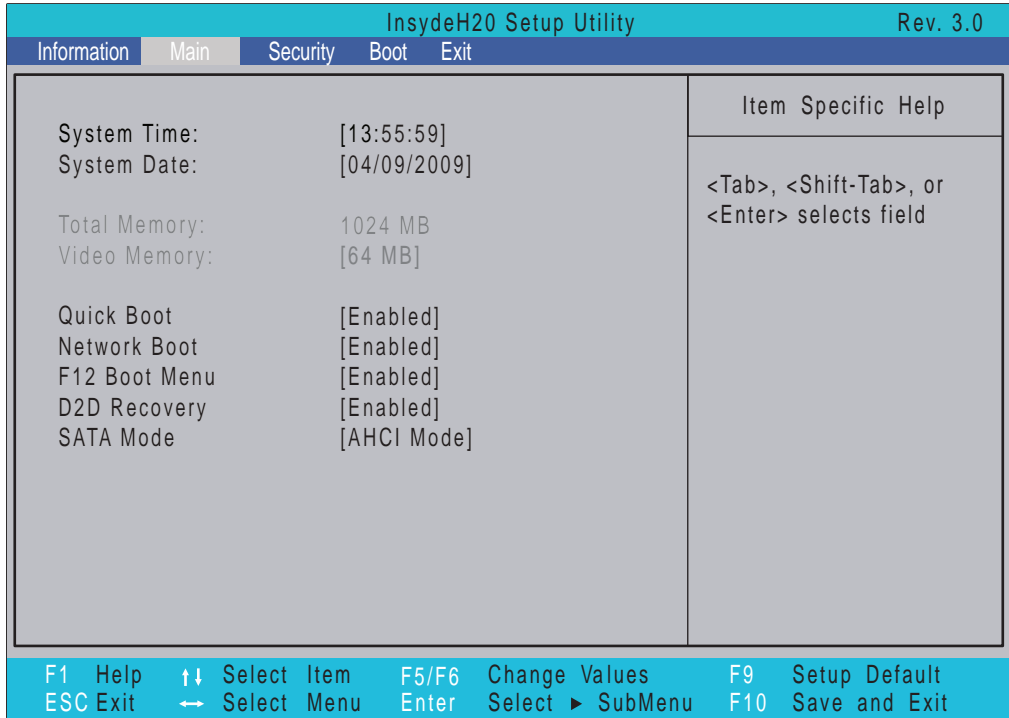

NOTE: The screen above is for your reference only. Actual values may differ.

The table below describes the parameters in this screen. Settings in **boldface** are the default and suggested parameter settings.

Parameter	Description	Format/Option
System Time	Sets the system time. The hours are displayed with 24-hour format.	Format: HH:MM:SS (hour:minute:second)
System Date	Sets the system date.	Format MM/DD/YYYY (month/day/year)
Total Memory	This field reports the memory size of the system. Memory size is fixed to 3017 MB.	N/A
Video Memory	Shows the video memory size. VGA Memory size=32 MB	N/A
Quick Boot	Allows startup to skip certain tests while booting, decreasing the time needed to boot the system.	Option: Enabled or Disabled
Network Boot	Enables, disables the system boot from LAN (remote server).	Option: Enabled or Disabled
F12 Boot Menu	Enables, disables Boot Menu during POST.	Option: Enabled or Disabled
D2D Recovery	Enables, disables D2D Recovery function. The function allows the user to create a hidden partition on hard disc drive to store operation system and restore the system to factory defaults.	Option: Enabled or Disabled
SATA Mode	Control the mode in which the SATA controller should operate.	Option: AHCI or IDE

Security

The Security screen contains parameters that help safeguard and protect your computer from unauthorized use.

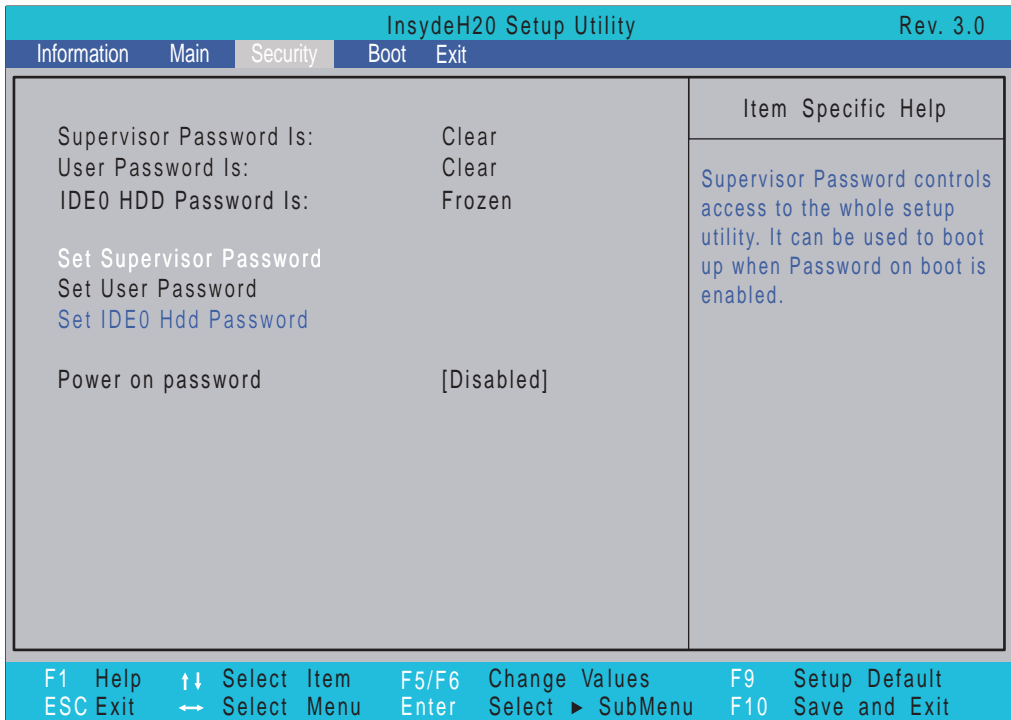

The table below describes the parameters in this screen. Settings in **boldface** are the default and suggested parameter settings.

Parameter	Description	Option
Supervisor Password Is	Shows the setting of the Supervisor password	Clear or Set
User Password Is	Shows the setting of the user password.	Clear or Set
IDEO HDD Password Is	Shows the setting of the HDD password	Clear or Set
Set Supervisor Password	Press Enter to set the supervisor password. When set, this password protects the BIOS Setup Utility from unauthorized access. The user can not either enter the Setup menu nor change the value of parameters.	
Set User Password	Press Enter to set the user password. When user password is set, this password protects the BIOS Setup Utility from unauthorized access. The user can enter Setup menu only and does not have right to change the value of parameters.	
Set IDEO Hdd Password	Enter to set the HDD password.	
Power on password	Defines whether a password is required or not while the events defined in this group happened. The following sub-options are all requires the Supervisor password for changes and should be grayed out if the user password was used to enter setup.	Enabled or Disabled

NOTE: When you are prompted to enter a password, you have three tries before the system halts. Don't forget your password. If you forget your password, you may have to return your notebook computer to your dealer to reset it.

Setting a Password

Follow these steps as you set the user or the supervisor password:

1. Use the ↑ and ↓ keys to highlight the Set Supervisor Password parameter and press the **Enter** key. The Set Supervisor Password box appears:



Set Supervisor Password	
Enter New Password	[██████████]
Confirm New Password	[██████████]

2. Type a password in the “Enter New Password” field. The password length can not exceeds 8 alphanumeric characters (A-Z, a-z, 0-9, not case sensitive). Retype the password in the “Confirm New Password” field.

IMPORTANT: Be very careful when typing your password because the characters do not appear on the screen.

3. Press **Enter**. After setting the password, the computer sets the User Password parameter to “Set”.
4. If desired, you can opt to enable the Password on boot parameter.
5. When you are done, press F10 to save the changes and exit the BIOS Setup Utility.

Removing a Password

Follow these steps:

1. Use the ↑ and ↓ keys to highlight the Set Supervisor Password parameter and press the **Enter** key. The Set Password box appears:



Set Supervisor Password	
Enter Current Password	[██████████]
Enter New Password	[██████████]
Confirm New Password	[██████████]

2. Type the current password in the Enter Current Password field and press **Enter**.
3. Press **Enter** twice **without** typing anything in the Enter New Password and Confirm New Password fields. The computer then sets the Supervisor Password parameter to “Clear”.
4. When you have changed the settings, press u to save the changes and exit the BIOS Setup Utility.

Changing a Password

1. Use the ↑ and ↓ keys to highlight the Set Supervisor Password parameter and press the **Enter** key. The Set Password box appears.



Set Supervisor Password	
Enter Current Password	[██████████]
Enter New Password	[██████████]
Confirm New Password	[██████████]

-
2. Type the current password in the Enter Current Password field and press **Enter**.
 3. Type a password in the Enter New Password field. Retype the password in the Confirm New Password field.
 4. Press **Enter**. After setting the password, the computer sets the User Password parameter to "Set".
 5. If desired, you can enable the Password on boot parameter.
 6. When you are done, press **F10** to save the changes and exit the BIOS Setup Utility.
- If the verification is OK, the screen will display as following.

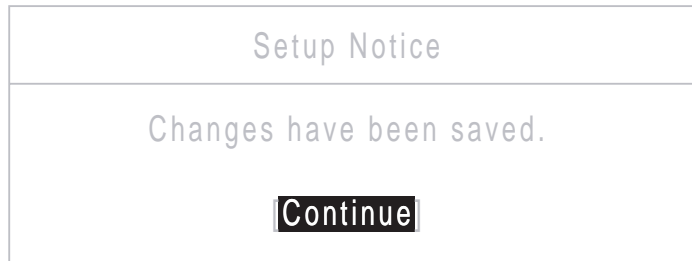

The password setting is complete after the user presses **Enter**.

If the current password entered does not match the actual current password, the screen will show you the Setup Warning.



If the new password and confirm new password strings do not match, the screen displays the following message.



Boot

This menu allows the user to decide the order of boot devices to load the operating system. Bootable devices includes the USB diskette drives, the onboard hard disk drive and the DVD drive in the module bay.

InsydeH20 Setup Utility				Rev. 3.0	
Information	Main	Security	Boot	Exit	
Boot priority order:				Item Specific Help	
1. IDE0 : ST960821A				Use <↑> or <↓> to select a device, then press <F5> to move it down the list, or <F6> to move it up the list. Press <Esc> to escape the menu	
2. IDE1 : MATSHITADVD					
3. USB FDD :					
4. Network Boot : Realtek Boot Agent					
5. USB HDD :					
6. USB CDROM :					
F1 Help	↑↓ Select Item	F5/F6 Change Values	F9 Setup Default		
ESC Exit	←→ Select Menu	Enter Select ► SubMenu	F10 Save and Exit		

Exit

The Exit screen allows you to save or discard any changes you made and quit the BIOS Utility.

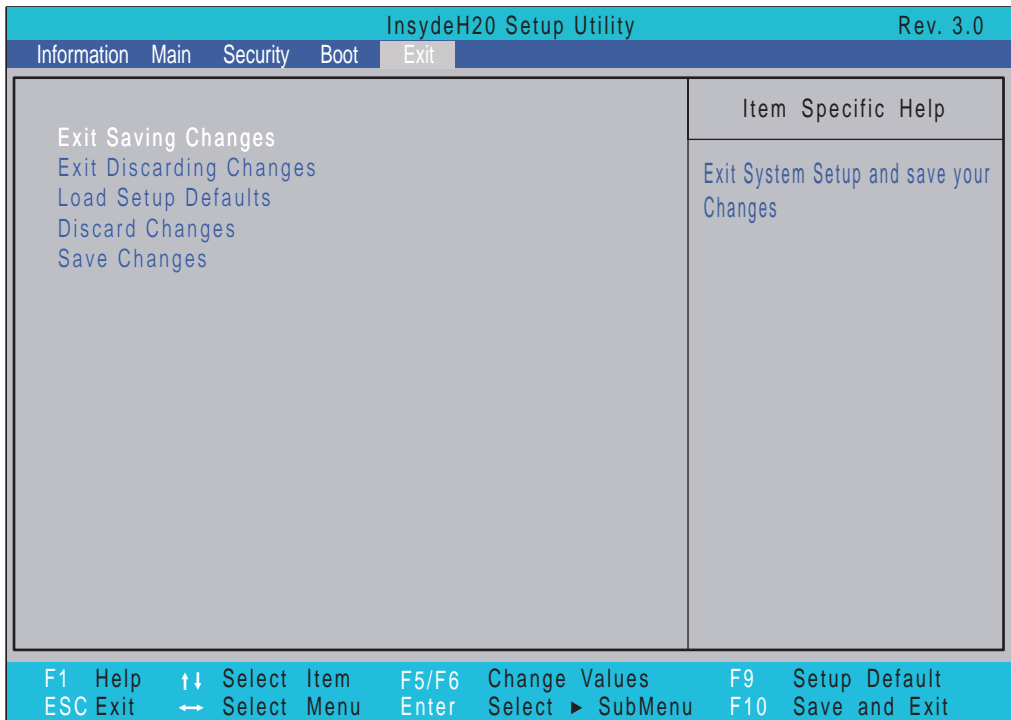

The table below describes the parameters in this screen.

Parameter	Description
Exit Saving Changes	Exit System Setup and save your changes to CMOS.
Exit Discarding Changes	Exit utility without saving setup data to CMOS.
Load Setup Default	Load default values for all SETUP item.
Discard Changes	Load previous values from CMOS for all SETUP items.
Save Changes	Save Setup Data to CMOS.

BIOS Flash Utility

The BIOS flash memory update is required for the following conditions:

- New versions of system programs
- New features or options
- Restore a BIOS when it becomes corrupted.

Use the Phlash utility to update the system BIOS flash ROM.

NOTE: If you do not have a crisis recovery diskette at hand, then you should create a **Crisis Recovery Diskette** before you use the Phlash utility.

NOTE: Do not install memory-related drivers (XMS, EMS, DPMI) when you use the Phlash.

NOTE: Please use the AC adaptor power supply when you run the Phlash utility. If the battery pack does not contain enough power to finish BIOS flash, you may not boot the system because the BIOS is not completely loaded.

Follow the steps below to run the Phlash.

1. Prepare a bootable diskette.
2. Copy the flash utilities to the bootable diskette.
3. Then boot the system from the bootable diskette. The flash utility has auto-execution function.

DOS Flash Utility

Perform the following steps to use the DOS Flash Utility:

1. Press F2 during boot to enter the Setup Menu.
2. Select **Boot Menu** to modify the boot priority order, for example, if using USB HDD to Update BIOS, move USB HDD to position 1.

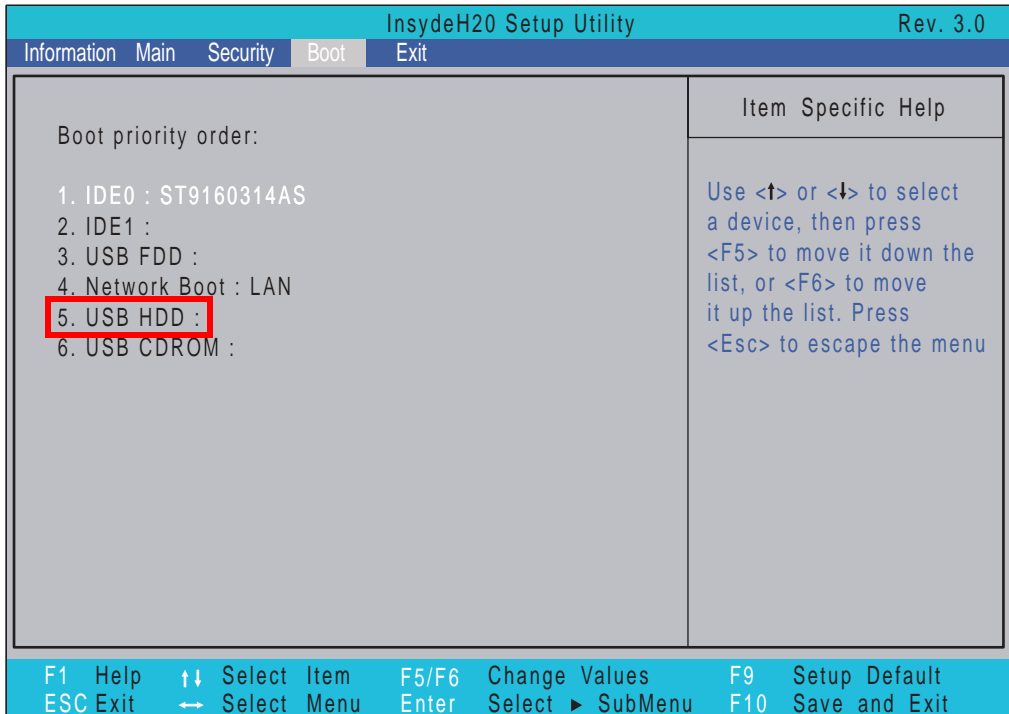

3. Execute the **IFLASH.BAT** batch file to update BIOS.

The flash process begins as shown.



4. In flash BIOS, the message **Please do not remove AC Power Source** displays.

NOTE: If the AC power is not connected, the following message displays.

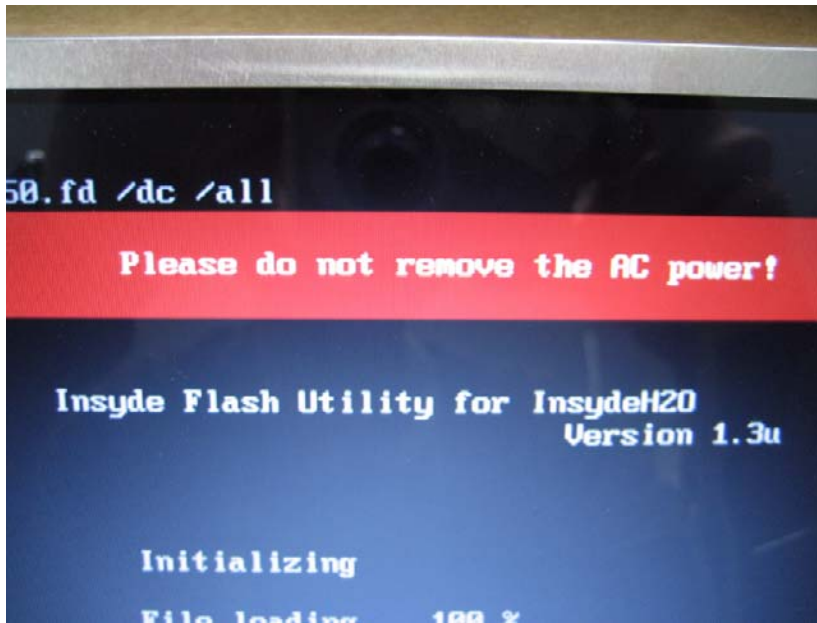

Plug in the AC power to continue.

5. Flash is complete when the message Flash programming complete displays.

WinFlash Utility

Perform the following steps to use the WinFlash Utility:

1. Double click the WinFlash executable.
2. Click **OK** to begin the update. A progress screen displays.

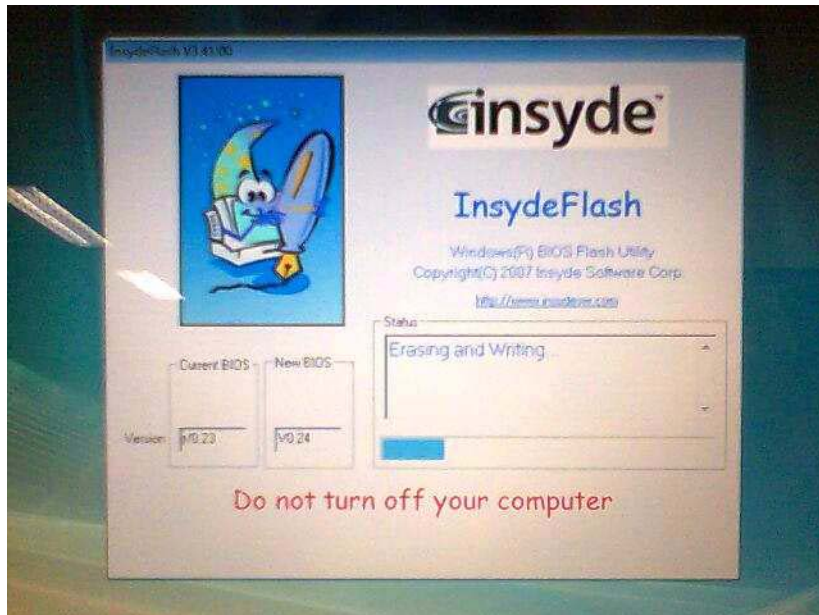

3. When the process is complete, close all programs and applications and reboot the system.

Remove HDD/BIOS Password Utilities

This section provides you with details about removing HDD/BIOS password methods:

Removing HDD Password:

If you key in the wrong HDD password three times, an error is generated.

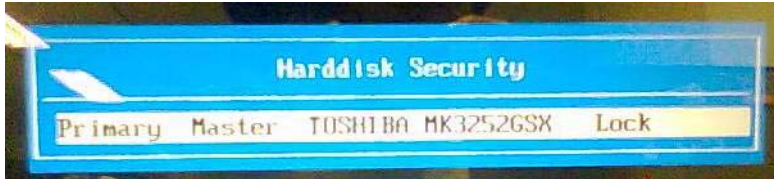

To reset the HDD password, perform the following steps:

1. After the error is displayed, select the **Enter Unlock Password** option on the screen.



2. An Encode key is generated for unlocking utilities. Note down this key.



3. Execute the **UnlockHD.EXE** file to create the unlock code in DOS Mode using the format **UnlockHD [Encode key]** with the code noted in the previous step, as follows:

UnlockHD 76943488

4. The command generates a password which can be used for unlocking the HDD.

Password: 46548274

5. Key in the password from the previous step to unlock the HDD as shown.

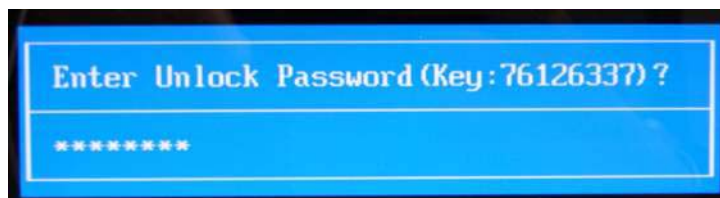

Removing BIOS Passwords:

To clear the User or Supervisor passwords, open the RAM door and use a metal instrument to short the **CLR2** jumper as shown below.

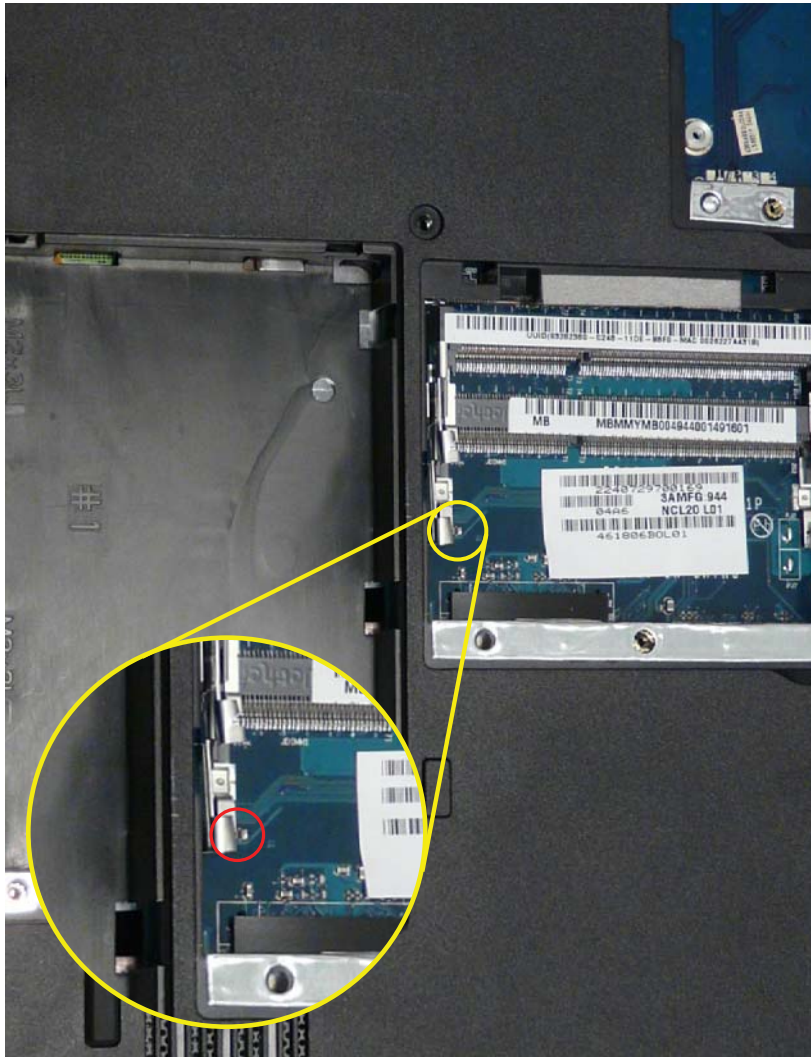

Cleaning BIOS Passwords

To clean the User or Supervisor passwords, perform the following steps:

1. From a DOS prompt, execute **clnPwd.exe**
2. Press 1 or 2 to clean the desired password shown on the screen.

```
d:\Clnpwd>clnpwd
ACER Clean Password Utility V1.00
Press 1 or 2 to clean any password shown as below
  1.User Password
  2.Supervisor Password

Clean User Password Successfully!
```

The onscreen message determines whether the function is successful or not.

Miscellaneous Utilities

Using Boot Sequence Selector

Boot Sequence Selector allows the boot order to be changed without accessing the BIOS. To use Boot Sequence Selector, perform the following steps:

1. Enter into DOS.
2. Execute BS.exe to display the usage screen.

```
d:\BOOTSEQ>bs

*** Boot Sequence Selector Version 0.03 ***
Create by Rockwell Chuang 10/01/2005.

Usage:
BS [ 1 | 2 | 3 | 4 ]

BS 1 : [ Floppy ] => [ HardDisk ] => [ CD-ROM ] => [ LAN ]
BS 2 : [ HardDisk ] => [ CD-ROM ] => [ LAN ] => [ Floppy ]
BS 3 : [ CD-ROM ] => [ HardDisk ] => [ LAN ] => [ Floppy ]
BS 4 : [ LAN ] => [ Floppy ] => [ HardDisk ] => [ CD-ROM ]

d:\BOOTSEQ>
```

3. Select the desired boot sequence by entering the corresponding sequence, for example, enter BS2 to change the boot sequence to HDD|CD ROM|LAN|Floppy.

Using DMITools

The DMI (Desktop Management Interface) Tool copies BIOS information to eeprom to be used in the DMI pool for hardware management.

When the BIOS displays **Verifying DMI pool data** it is checking the table correlates with the hardware before sending to the operating system (Windows, etc.).

To update the DMI Pool, perform the following steps:

1. Enter into DOS.
2. Execute **dmitools.exe**. The following messages show dmitools usage:
DMITools [/R | /WP | /WS | /WU] [STRING]
 - dmitools /r ==> Read dmi string from bios
 - dmitools /wm xxxx ==> Write manufacturer name to eeprom
 - dmitools /wp xxxx ==> Write product name to eeprom
 - dmitools /ws xxxx ==> Write serial number to eeprom
 - dmitools /wu xxxx ==> Write uuid to eeprom
 - dmitools /wa xxxx ==> Write asset tag to eeprom

IMPORTANT:The following write examples (2 to 5) require a system reboot to take effect

Example 1: Read DMI Information from Memory

Input:

```
dmitools /r
```

Output:

```
Manufacturer (Type1, Offset04h): Acer  
Product Name (Type1, Offset05h): TravelMate xxxxx  
Serial Number (Type1, Offset07h): 01234567890123456789  
UUID String (Type1, Offset08h): xxxxxxxx-xxxx-xxxx-xxxx-xxxxxxxxxxxx  
Asset Tag (Type3, Offset04h): Acer Asstag
```

Example 2: Write Product Name to EEPROM

Input:

```
dmitools /wp Acer
```

Example 3: Write Serial Number to EEPROM

Input:

```
dmitools /ws 01234567890123456789
```

Example 4: Write UUID to EEPROM (Create UUID from Intel WFM20.pdf)

Input:

```
dmitools /wu
```

Example 5: Write Asset Tag to EEPROM

Input:

```
dmitools /wa Acer Asstag
```

Using the LAN MAC Utility

Perform the following steps to write MAC information to eeprom:

1. Use a text editor, for example Notepad, to edit the MAC.CFG file as shown:



- WriteData= '001122334455' <----- MAC value
 - StartAddr=7A <----- MAC address
 - WriteLeng=6 <----- MAC value length
 - KeepByte=0 <----- can be any value
2. Boot into DOS.
 3. Execute **MAC.BAT** to write MAC information to eeprom.

```
C:\MAC>mac.bat  
C:\MAC>eeprom w MAC.cfg  
Progress --> \  
Write Data to EEPROM OK!!
```

Machine Disassembly and Replacement

This chapter contains step-by-step procedures on how to disassemble the notebook computer for maintenance and troubleshooting.

Disassembly Requirements

To disassemble the computer, you need the following tools:

- Wrist grounding strap and conductive mat for preventing electrostatic discharge
- Philips screwdriver
- Plastic flat screwdriver
- Plastic tweezers

NOTE: The screws for the different components vary in size. During the disassembly process, group the screws with the corresponding components to avoid mismatch when putting back the components.

General Information

Pre-disassembly Instructions

Before proceeding with the disassembly procedure, make sure that you do the following:

1. Turn off the power to the system and all peripherals.
2. Unplug the AC adapter and all power and signal cables from the system.



3. Place the system on a flat, stable surface.
4. Remove the battery pack.

Disassembly Process

The disassembly process is divided into the following stages:

- External module disassembly
- Main unit disassembly
- LCD module disassembly

The flowcharts provided in the succeeding disassembly sections illustrate the entire disassembly sequence. Observe the order of the sequence to avoid damage to any of the hardware components. For example, if you want to remove the mainboard, you must first remove the keyboard, then disassemble the inside assembly frame in that order.

Main Screw List

Screw	Quantity	Part Number
M2*3	30	86.WHA02.001
M2*4	6	86.WHA02.002
M2*6	14	86.WHA02.003
M2*10	6	86.WHA02.004
M3*3	4	86.WHA02.005

External Module Disassembly Process

IMPORTANT:The outside housing and color may vary from the mass produced model.

External Modules Disassembly Flowchart

The flowchart below gives you a graphic representation on the entire disassembly sequence and instructs you on the components that need to be removed during servicing. For example, if you want to remove the mainboard, you must first remove the keyboard, then disassemble the inside assembly frame in that order.

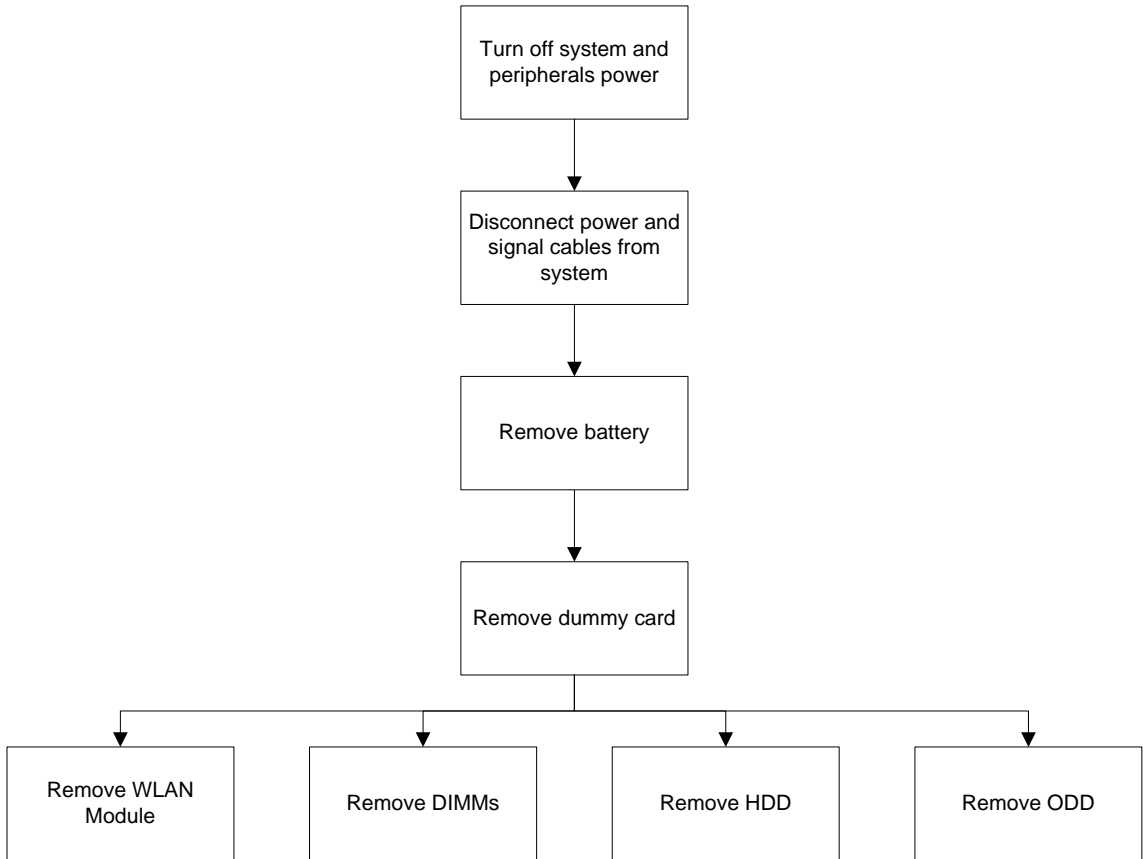

Screw List

Step	Screw	Quantity	Part No.
WLAN Module	M2*3	1	86.WHA02.001
WLAN Module	M2*6	1	86.WHA02.003
DIMM Module	M2*6	1	86.WHA02.003
HDD Module	M2*6	2	86.WHA02.003
HDD Carrier	M3*3	4	86.WHA02.001
ODD Module	M2*6	1	86.WHA02.003
ODD Bracket	M2*3	2	86.WHA02.001

Removing the Battery Pack

1. Turn computer over. Slide the battery lock in the direction shown.



2. Slide and hold the battery release latch to the release position (1), then lift out the battery pack from the main unit (2).



Removing the SD Dummy Card

1. Push the SD dummy card inwards to eject it.



2. Pull the card out from the slot.



Removing the DIMM Module

- 1. Remove the one (1) screw from the RAM cover.



Step	Size	Quantity	Screw Type
RAM Cover	M2*6	1	

- 2. Lift off the RAM cover.



- 3. Push out the release latches on both sides of the DIMM socket to release the DIMM module.



4. Remove the DIMM module.



Removing the HDD Module

- 1. See "Removing the Battery Pack" on page 40.
- 2. Remove the two (2) screws on the HDD cover.



Step	Size	Quantity	Screw Type
HDD Module	M2*6	2	

3. Lift up the HDD cover at the location shown and remove.



4. Lift out the plastic pull-tab.

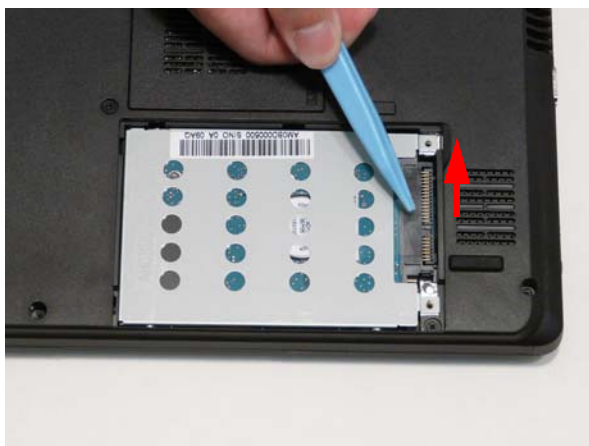

5. Grasp the pull-tab and pull the HDD module out of the bay.

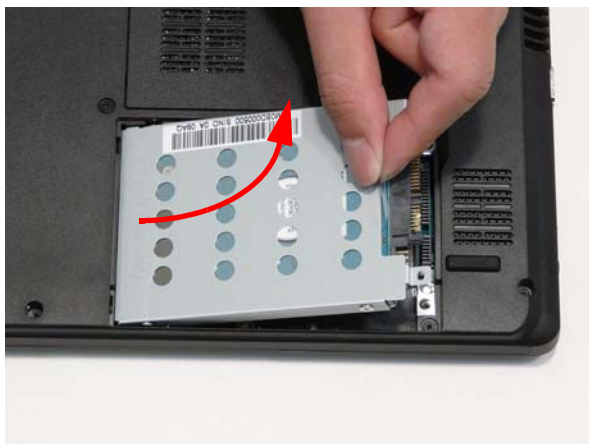

6. Remove the four (4) screws (two each side) securing the hard disk to the carrier in the order that they are shown printed on the hard disk carrier: 1, 2, 3 then 4.

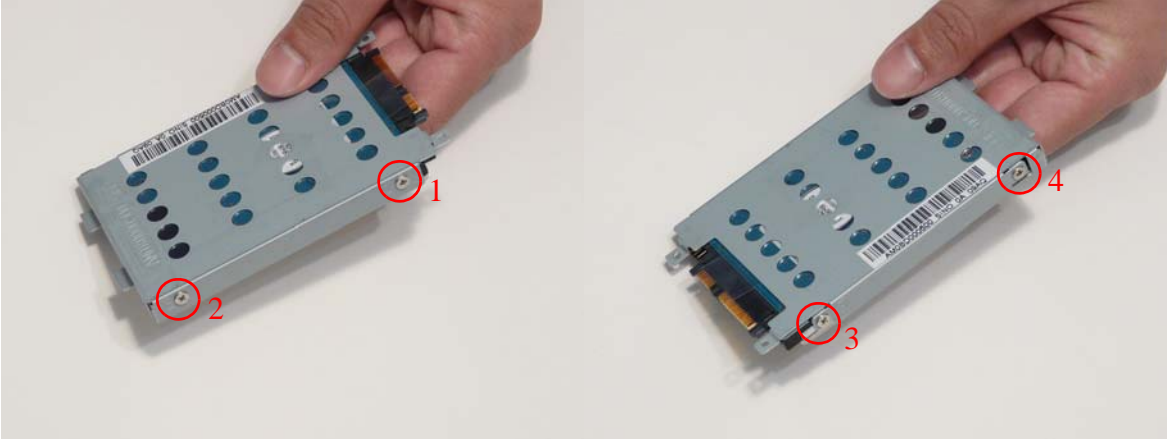

Step	Size	Quantity	Screw Type
HDD Carrier	M3*3	4	

7. Remove the carrier from the HDD.

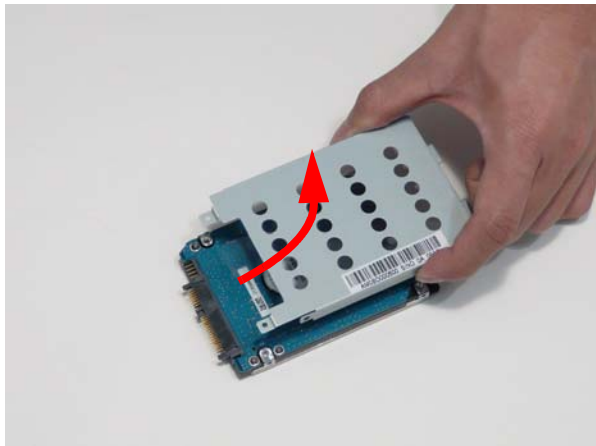

Removing the WLAN Module

1. See "Removing the Battery Pack" on page 40.
2. Remove the screw on the WLAN cover.



Step	Size	Quantity	Screw Type
WLAN Cover	M2*3	1	

3. Lift up the WLAN cover and remove.



4. Disconnect the antenna cables from the WLAN Module.



NOTE: Cable placement is **Black** to the **MAIN** terminal (left) and **White** to the **AUX** terminal (right).

5. Move the antennas away and remove the one (1) screw.



Step	Size	Quantity	Screw Type
WLAN Module	M2*3	1	

6. Remove the WLAN Module from the WLAN socket.



NOTE: When reattaching the antennas, ensure the cables are tucked into the chassis to prevent damage.

Removing the ODD Module

1. See “Removing the Battery Pack” on page 40.
2. Ensure screw holding ODD module in place is removed.



Step	Size	Quantity	Screw Type
ODD Module	M2*6	1	

3. Use a paperclip or other straight pin to manually eject the ODD.



4. Gently pull the ODD from the chassis.



5. Pry the face off of the ODD.



6. Pull cover from the front of the ODD.

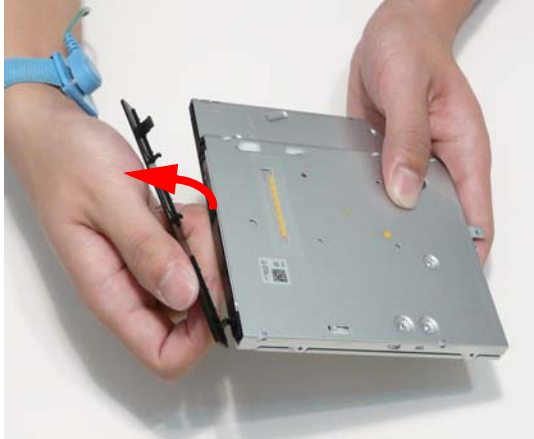

7. Remove two (2) screws from ODD bracket.



Step	Size	Quantity	Screw Type
ODD Bracket	M2x3	2	

8. Remove the bracket from the ODD module.



Main Unit Disassembly Process

Main Unit Disassembly Flowchart

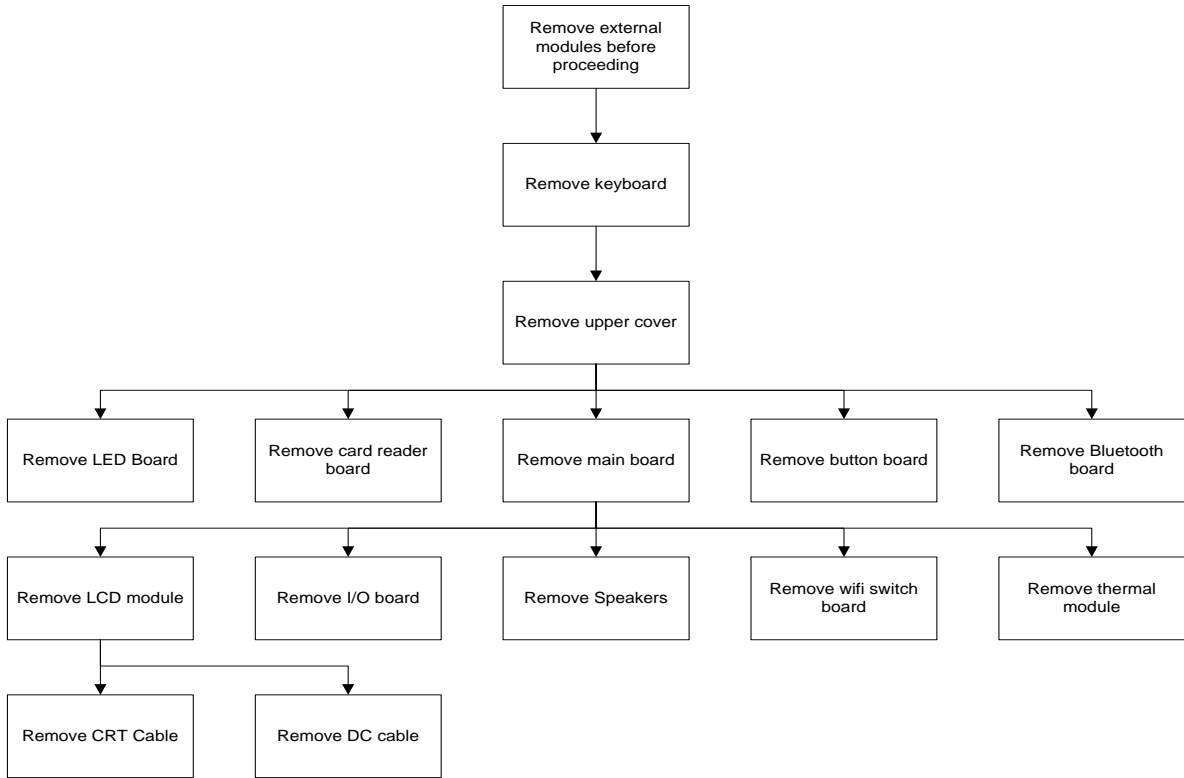

Screw List

Step	Screw	Quantity	Part No.
Upper Cover	M2*10	6	86.WHA02.004
Lower Cover	M2*6	8	86.WHA02.003
HDD Bay	M2*3	2	86.WHA02.001
	M2*6	1	86.WHA02.003
Button Board	M2*3	2	86.WHA02.001
LED Board	M2*3	1	86.WHA02.001
Card Reader Board	M2*3	2	86.WHA02.001
Bluetooth Board	M2*3	1	86.WHA02.001
Mainboard	M2*3	2	86.WHA02.001
Thermal Module	M2*3	4	86.WHA02.001
I/O Board	M2*3	2	86.WHA02.001
Wi-Fi Switch Board	M2*3	1	86.WHA02.001
Speakers	M2*3	2	86.WHA02.001
LCD Hinges	M2*4	4	86.WHA02.002

Removing the Keyboard

1. Push down on the four (4) latches holding the keyboard in place. The latches are behind and between keys esc/F1, F5/F6, F10/F11 and Ins/Del.



2. Release each latch one at a time from.



3. Gently pry up the keyboard from the back.



4. Turn the keyboard over but do not pull it away from the computer.

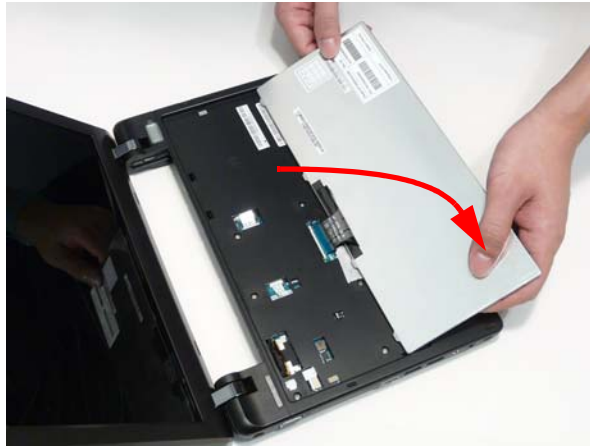

5. Unlock the FPC.

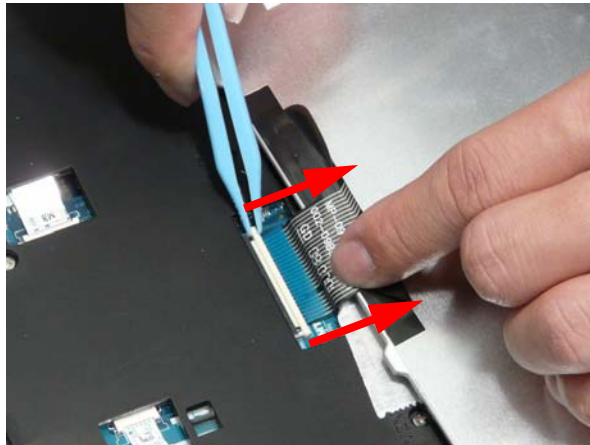

6. Remove the FPC and the keyboard.

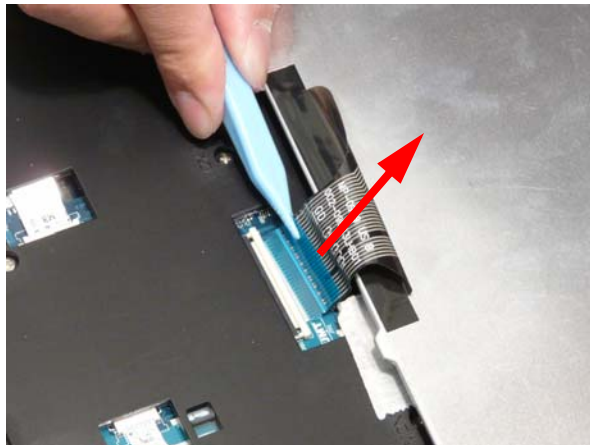

Removing the Upper Cover

1. See "Removing the Keyboard" on page 52.
2. Remove the adhesive tape from the button board FFC. Remove the button board FFC.

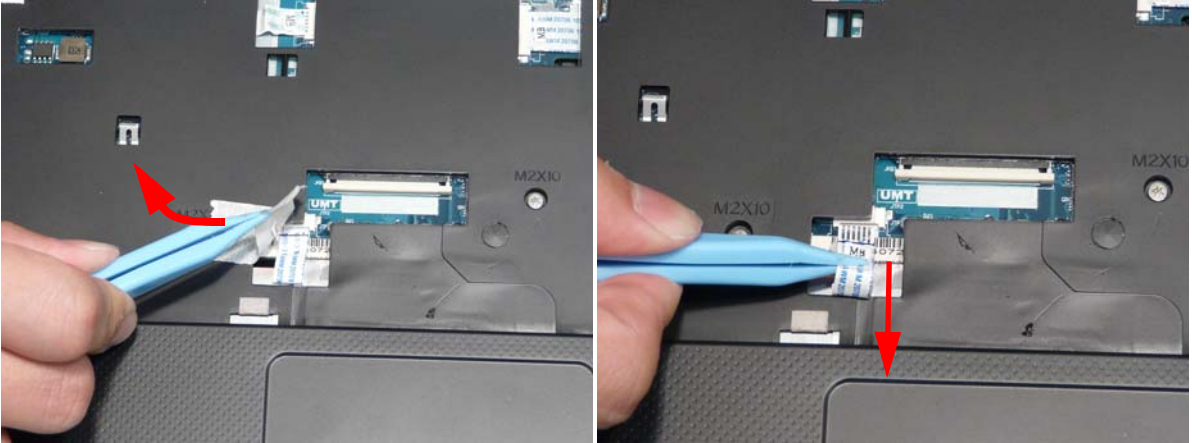

3. Pull out and remove the function board FFC. Then pull out and remove the I/O board FFC.



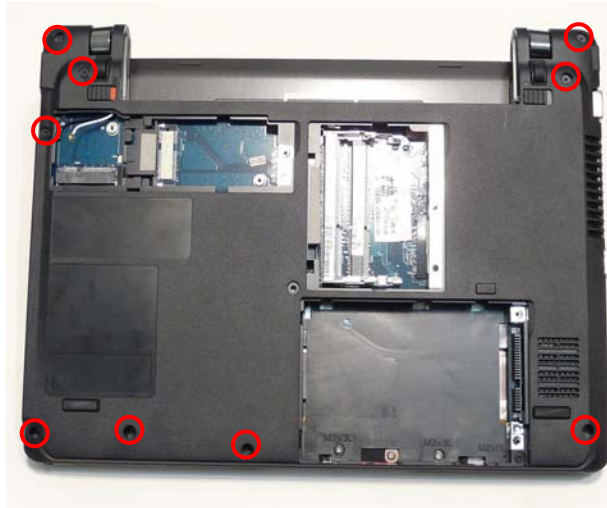

4. Turn the computer over and remove the nine (9) screws in the bottom cover.



Step	Size	Quantity	Screw Type
Lower Cover	M2*6	9	

5. Remove three (3) screws from the HD bay.



Step	Size	Quantity	Screw Type
HDD bay	M2*3	2	
	M2*6	1	

6. Turn the computer over again. Remove six (6) screws from the keyboard bay.

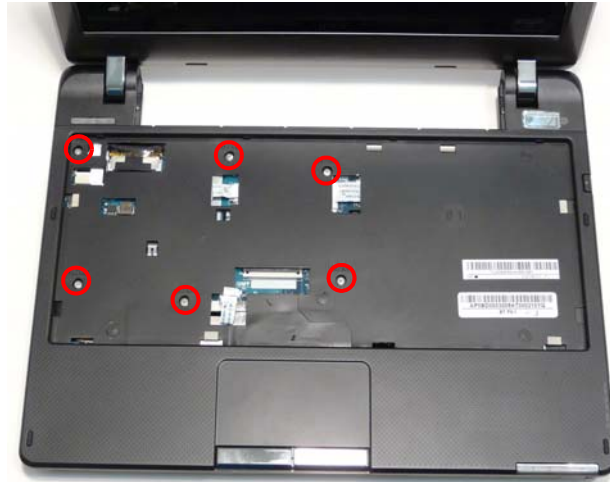

Step	Size	Quantity	Screw Type
Keyboard Bay	M2*10	6	

7. Begin removing the upper cover by prying the cover up at the left hinge as shown below.



8. Continue to pry the covers apart, moving away from the left hinge.



9. Pry up the cover around the right hinge.



10. Pull the upper cover up off the bottom cover.



11. Remove the upper cover.



Removing the LED Board

1. See "Removing the Upper Cover" on page 54.
2. Pull up on LED board FFC to disengage the adhesive and lift the FFC from the upper cover

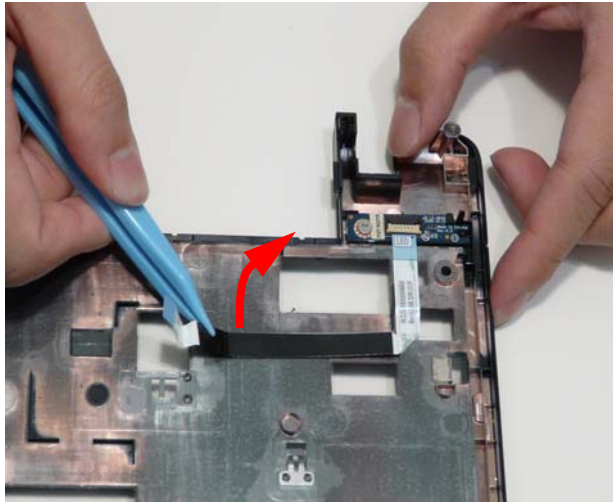

3. Unlock and remove the LED FFC from the LED Board.

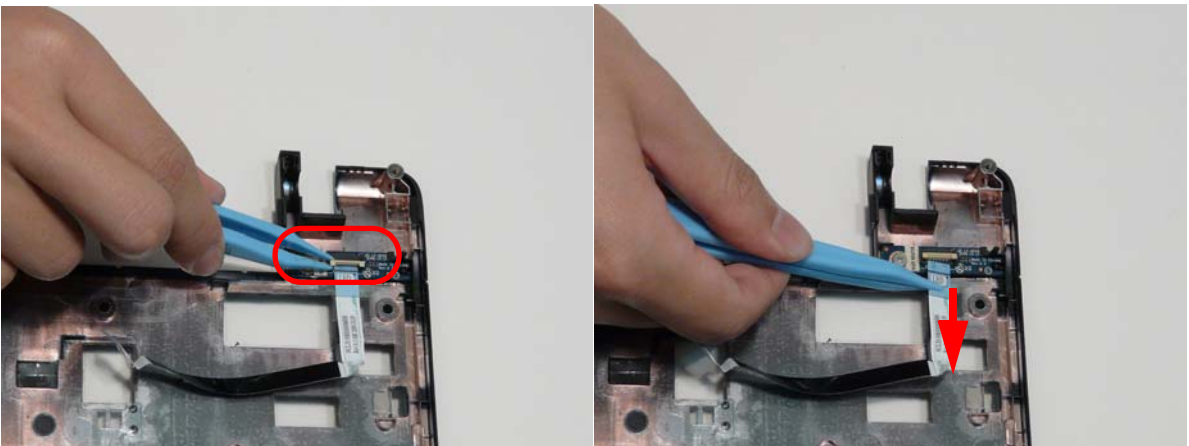

4. Remove the one (1) screw.

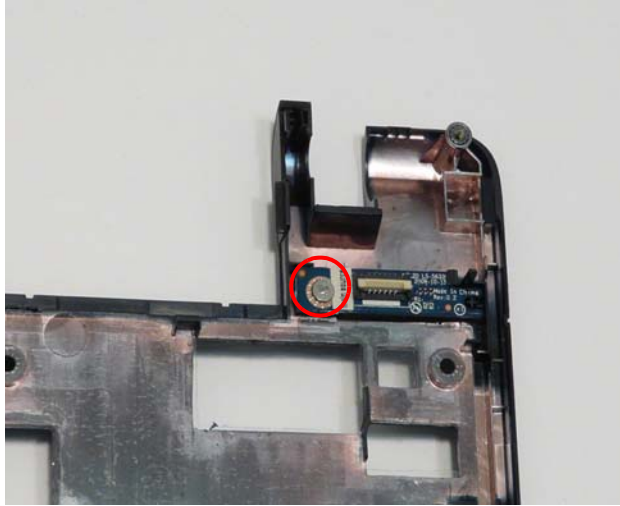

Step	Size	Quantity	Screw Type
LED Board	M2*3	1	

5. Lift the LED Board away from the chassis.

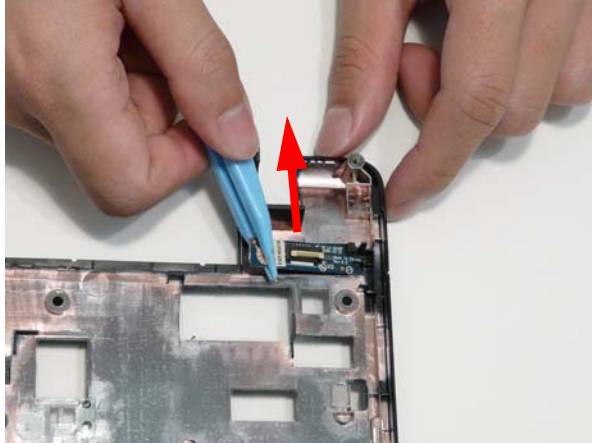

Removing the Card Reader Board

1. See "Removing the Upper Cover" on page 54.
2. Detach the adhesive plastic covering the Card Reader and ODD Eject FFCs from the upper cover

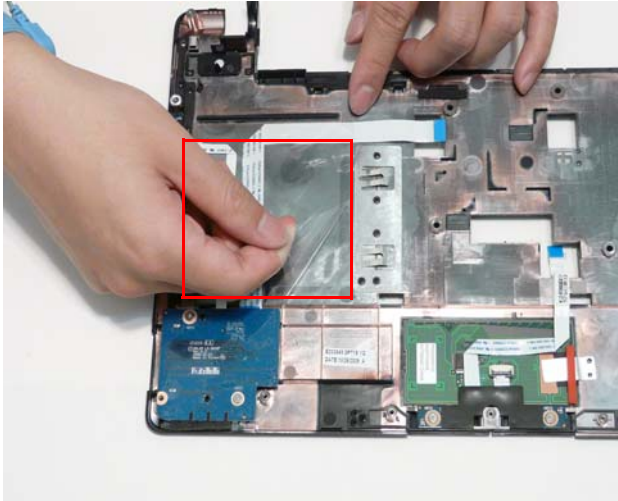

3. Remove one (1) screw from ODD Eject board and two (2) screws from the Card Reader Board



Step	Size	Quantity	Screw Type
ODD Eject Board	M2*3	1	
Card Reader Board	M2*3	2	

4. Lift the ODD Eject board up and away from the guide pin.

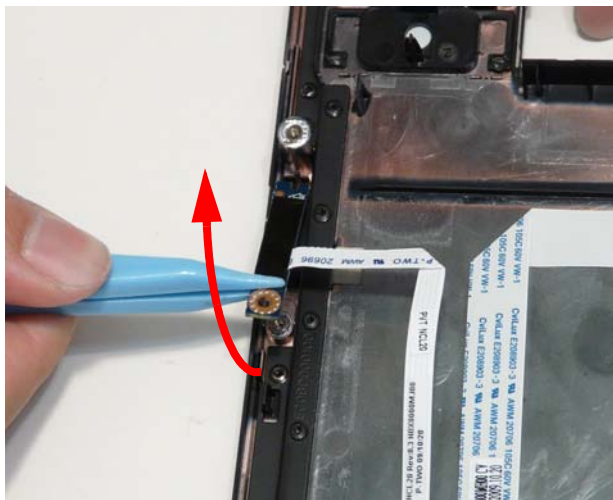

5. Lift the Card Reader board away from the upper case.

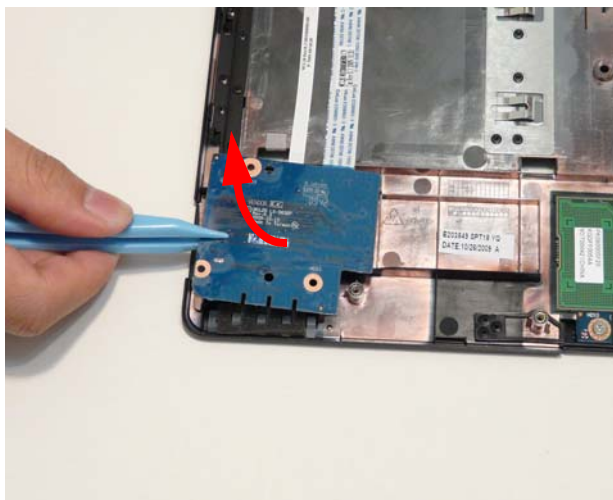

6. Pull the two (2) FFC cables from the Card Reader Board.

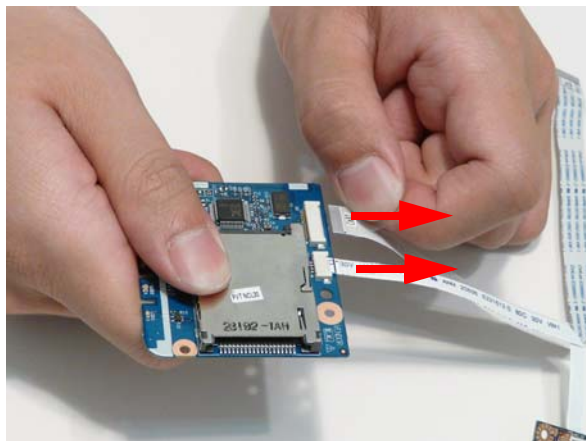

Removing the Button Board

1. See "Removing the Upper Cover" on page 54.
2. Detach the button board FFC from the touchpad.

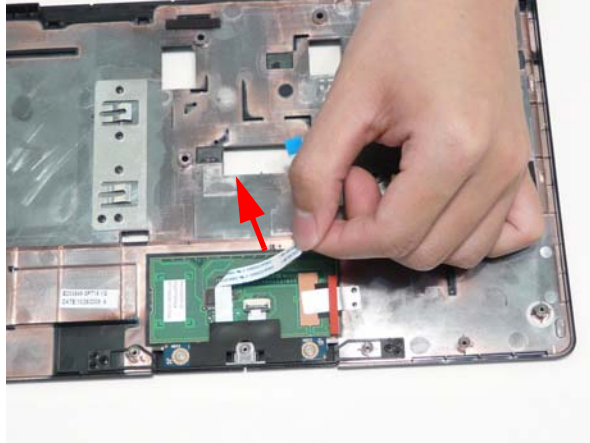

3. Release the touchpad FFC locking latch and disconnect the touchpad FFC from the cover.

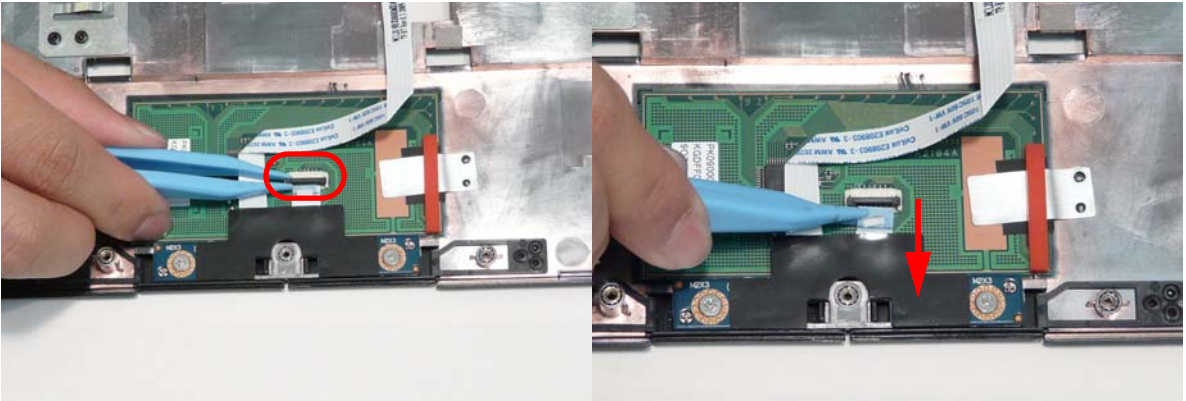

4. Remove the two (2) screws securing the TouchPad Bracket to the Upper Cover.



Step	Size	Quantity	Screw Type
Button Board	M2*3	2	

5. Remove the button board from the Upper Cover.

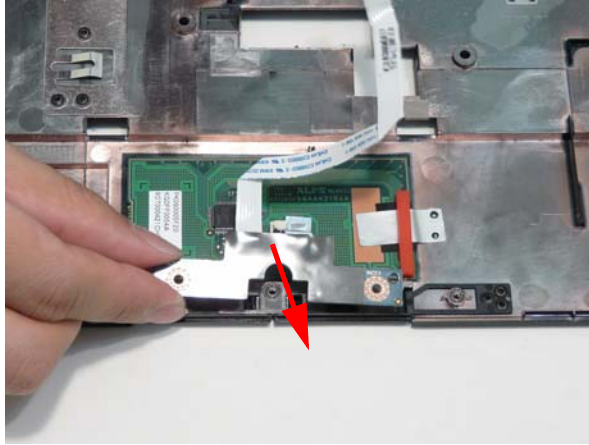

Removing the Bluetooth Module

1. See "Removing the Upper Cover" on page 54.
2. Remove the one (1) screw from the Bluetooth module.

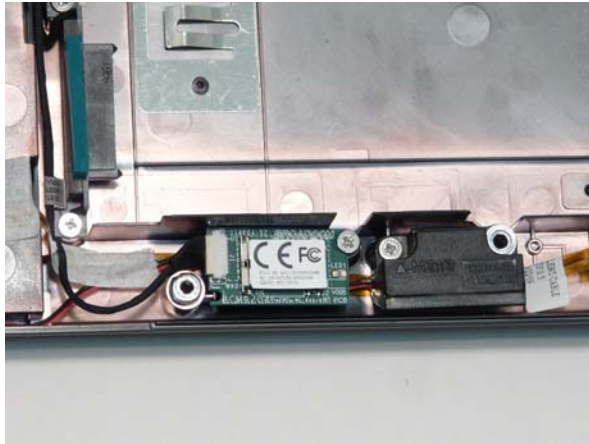

Step	Size	Quantity	Screw Type
Bluetooth Module	M2*3	1	

3. Disconnect the Bluetooth cable from the mainboard.

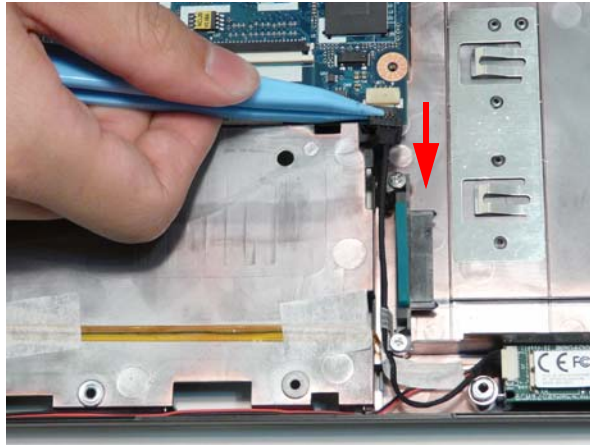

4. Remove the Bluetooth module (1) and disconnect the Bluetooth cable from the Bluetooth module (2).

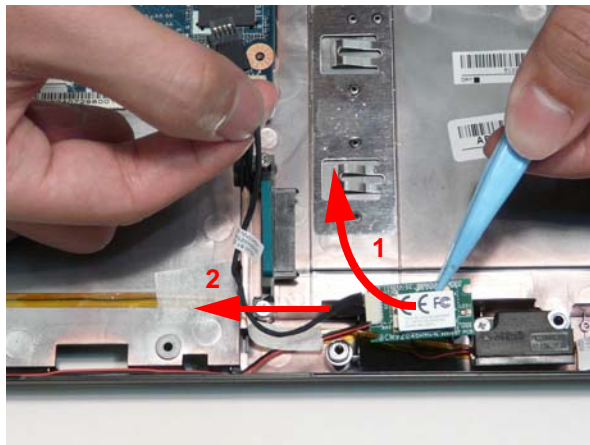

Removing the Mainboard

1. *See "Removing the Function Board" on page 72.
2. *See "Removing the Function Board" on page 72.
3. *See "Removing the Function Board" on page 72.
4. *See "Removing the LCD Module" on page 73.
5. *See "Removing the Bridge Board" on page 65.
6. Remove two (2) HDD connector screws.



Step	Size	Quantity	Screw Type
Mainboard	M2*3	2	

7. Disconnect the speaker and card reader board cable.

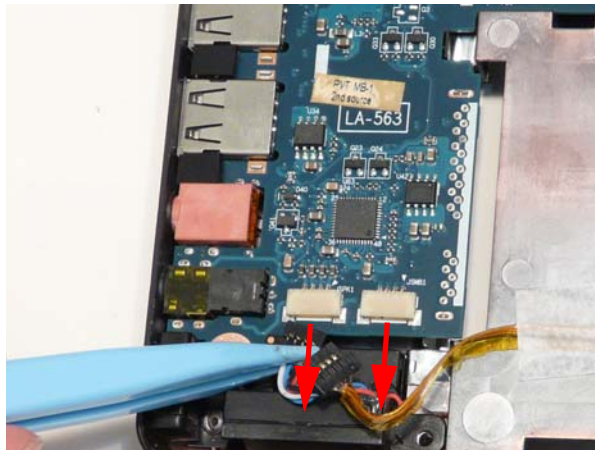

8. Disconnect the LVDS cable using the pull tab.

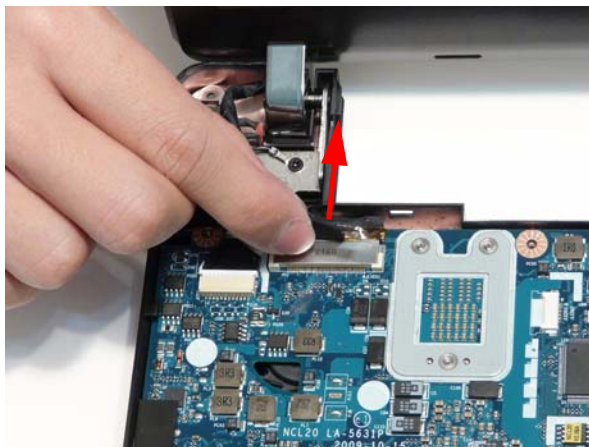

9. Remove the CRT cable.

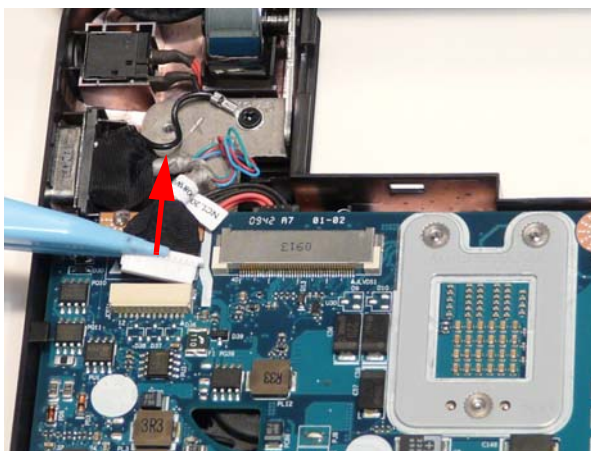

10. Partially lift the Main Board out of the chassis, lifting at the side closest to the ODD as indicated below.



11. Tilt up the mainboard to expose the DC Power cable (1). Remove the DC cable (2). Place the mainboard on a clean, flat surface.

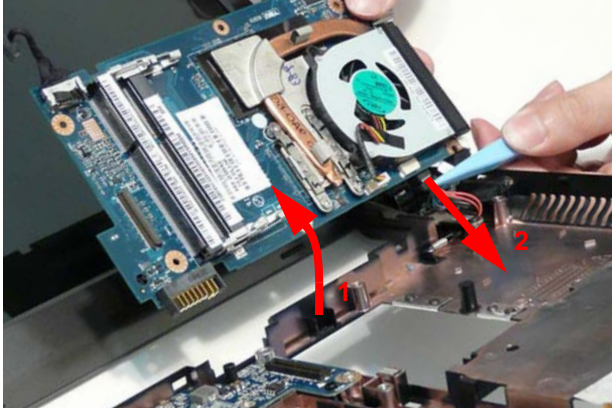

12. Remove the HDD connector cable from the Main Board.

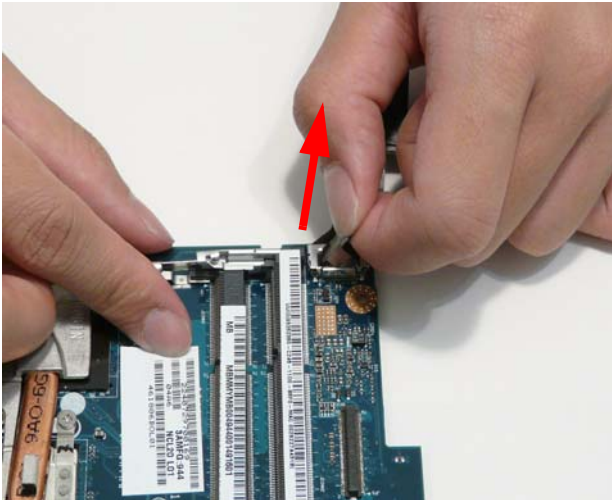

Removing the Thermal Module

1. See “Removing the Mainboard” on page 68.
2. Disconnect the fan cable.

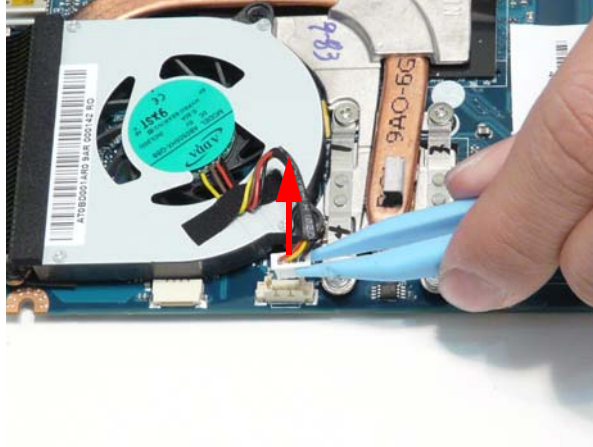

3. Remove the four (4) screws in the order labelled on the unit (1, 2, 3, 4).



Step	Size	Quantity	Screw Type
Thermal Module	M2*3	4	

4. Remove the thermal module from the mainboard.



Removing the I/O Board

1. See "Removing the Upper Cover" on page 54.
2. See *** Mainboard
3. Remove two (2) screws.



Step	Size	Quantity	Screw Type
I/O Board	M2*3	2	

4. Remove the I/O board from the chassis.



Removing the Speaker Module

- 1. See "Removing the I/O Board" on page 66.
- 2. See "Removing the Mainboard" on page 68.
- 3. Remove the four (4) screws.

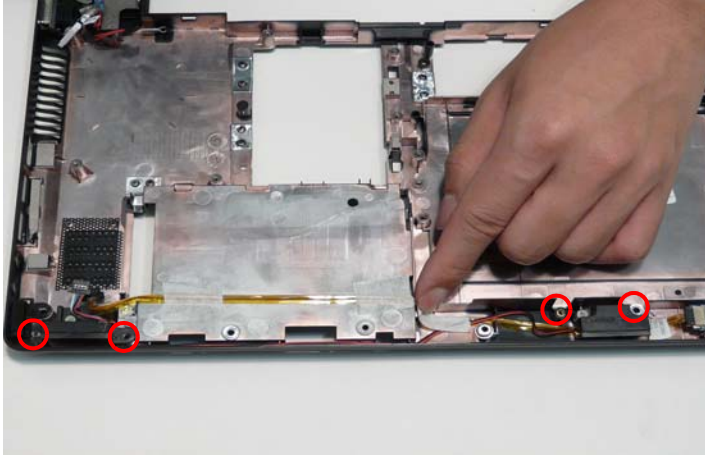

Step	Size	Quantity	Screw Type
Speakers	M2*3	4	

- 4. Remove the cables from the retention guides and pull the left speaker away.

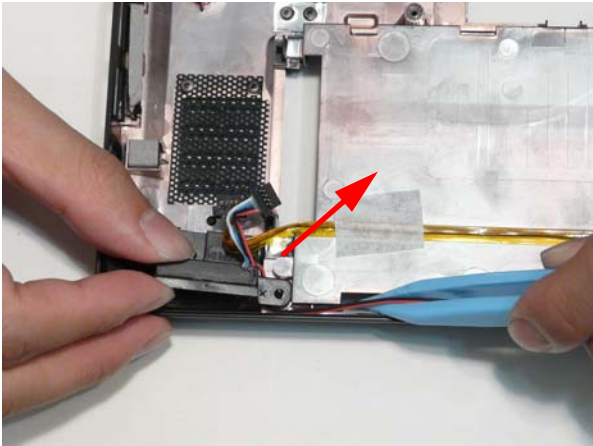

5. Lift out entire speaker module.

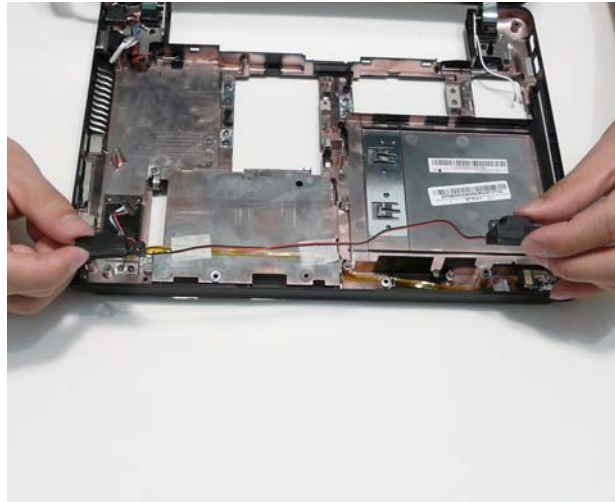

Removing the Function Board

1. See "Removing the Upper Cover" on page 54.
2. See "Removing the Main Board"
3. Remove the adhesive tape over the cables.

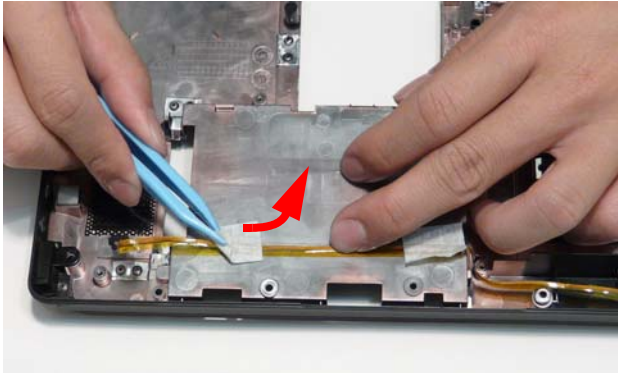

4. Remove the one (1) screw.



Step	Size	Quantity	Screw Type
Function Board	M2*3	1	

5. Unlock and disconnect the function board FFC.



Removing the LCD Module

1. See “Removing the Mainboard” on page 68.
2. Remove the two (2) screws from the left LCD hinge.

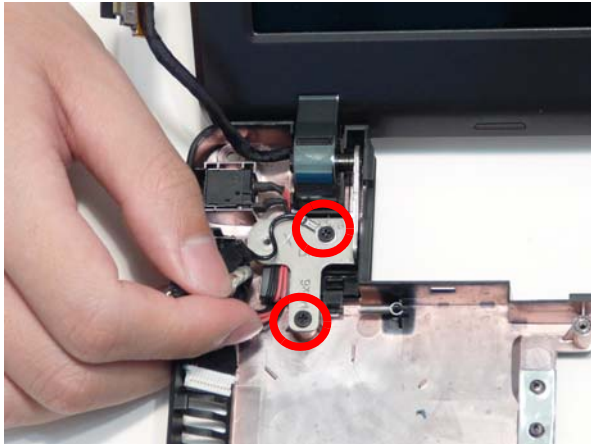

Step	Size	Quantity	Screw Type
LCD Module	M2*4	2	

3. Remove the two (2) screws from the right LCD hinge.

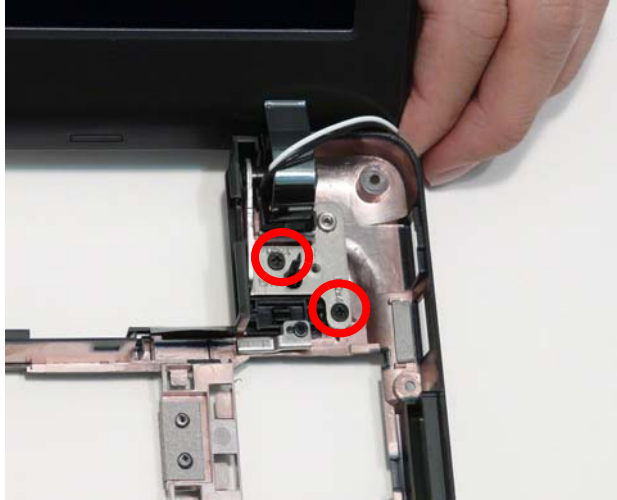

Step	Size	Quantity	Screw Type
LCD Module	M2*4	2	

4. Remove the LCD Module from the chassis.

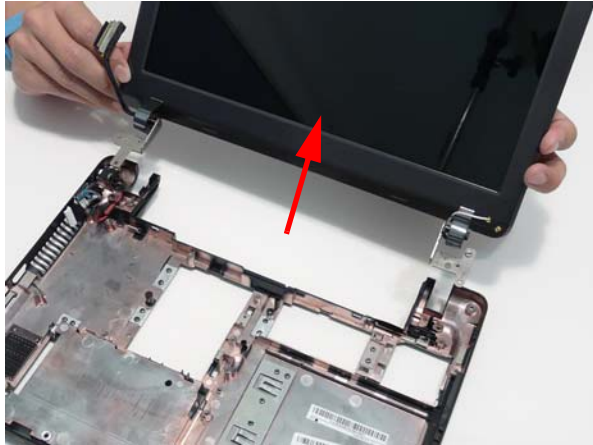

Removing the VGA Cable

1. See "Removing the Upper Cover" on page 54.
2. See "Removing the Main Board
3. Lift the VGA cable up and out of the chassis.

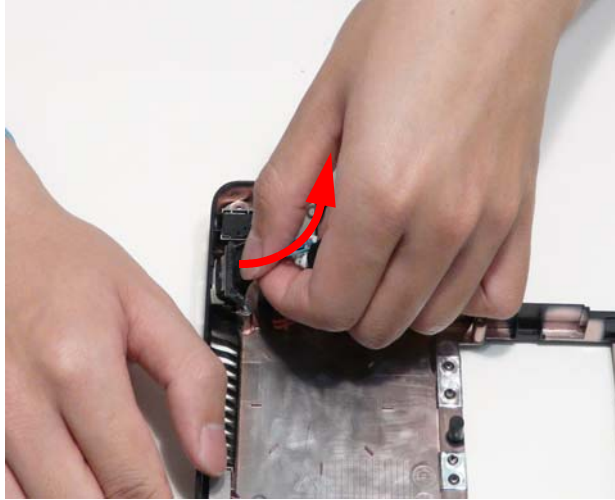

Removing the DC Jack

1. See "Removing the Upper Cover" on page 54.
2. See "Removing the Main Board"
3. Lift the cable bundle out of its retainer.

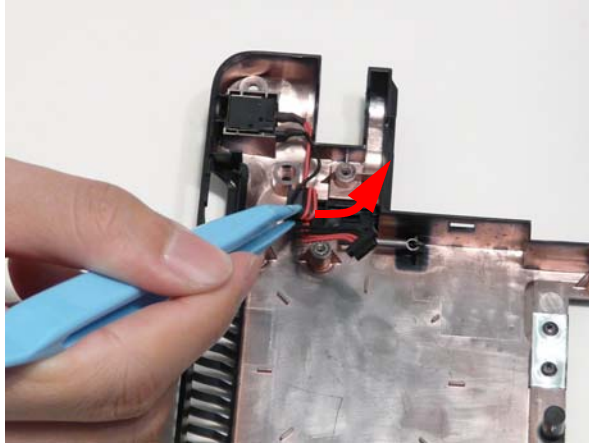

4. Lift the DC jack and cable out of the chassis.

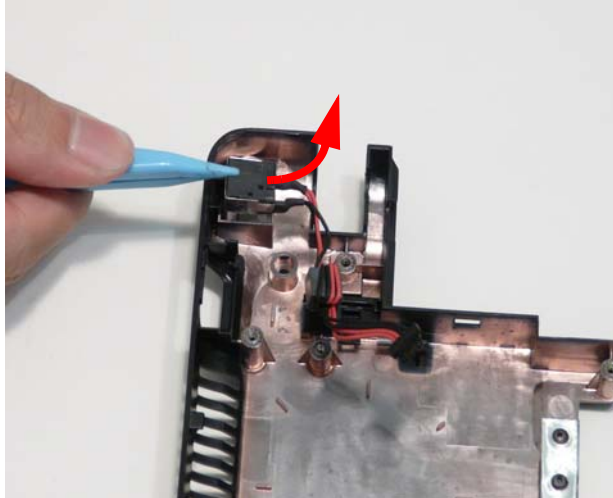

LCD Module Disassembly Process

LCD Module Disassembly Flowchart

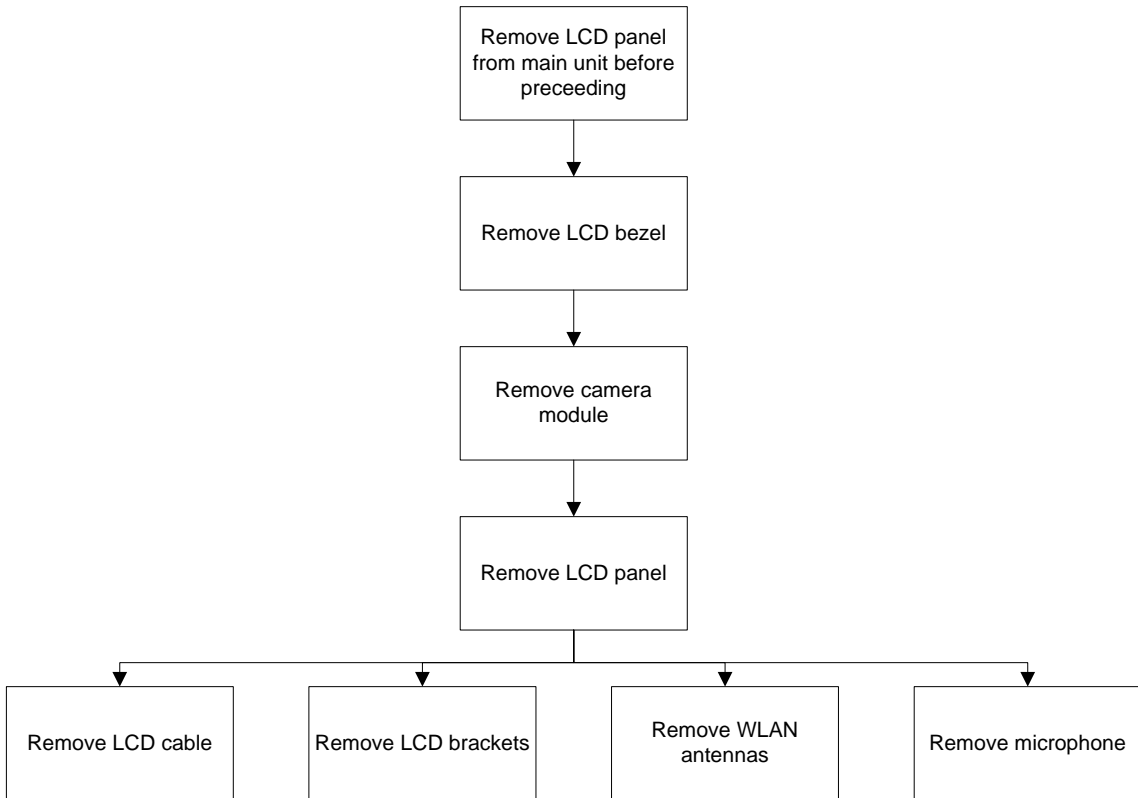

Screw List

Step	Screw	Quantity	Part No.
LCD Panel	M2*3	6	86.WHA02.001
LCD Brackets	M2*3	4	86.WHA02.001

Removing the LCD Bezel

1. See "Removing the LCD Module" on page 73.
2. Begin by prying up the bezel from the top-right corner of the LCD.



3. Work your way to the other corner of the LCD, prying up the bezel from the LCD.



4. Pry the bezel down the left and right sides towards the hinges (see below). Tilt the bezel up to 30° to disengage the bezel from clips (see note below) located inside the hinges and remove the bezel from the LCD.

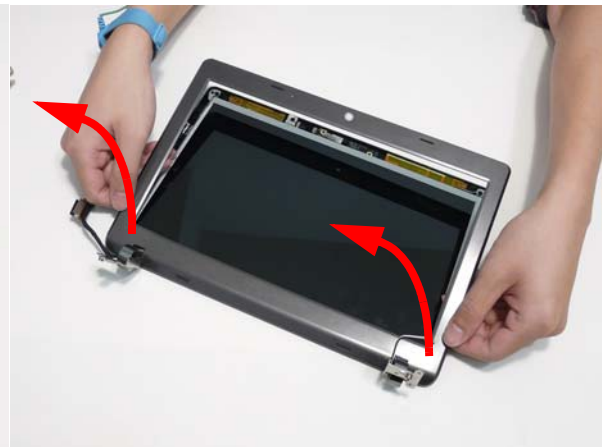

NOTE: Tilt up the bezel away from the LCD module to disengage the clasps inside the hinges.



Removing the Camera Module

1. See “Removing the LCD Bezel” on page 78.
2. Disconnect the camera cable.

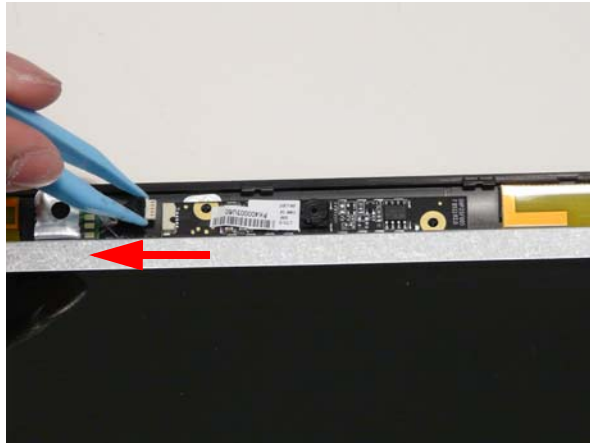

3. Pry the camera from the module.

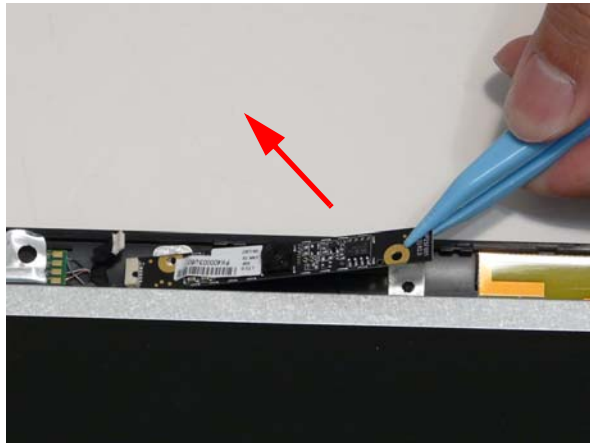

Removing the LCD Panel

- 1. See "Removing the Camera Module" on page 79.
- 2. Lift the foil off the LCD cable.

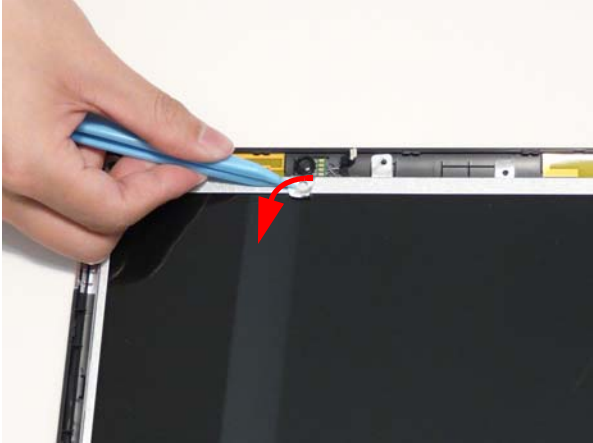

- 3. Remove the six (6) securing screws from the LCD Panel.

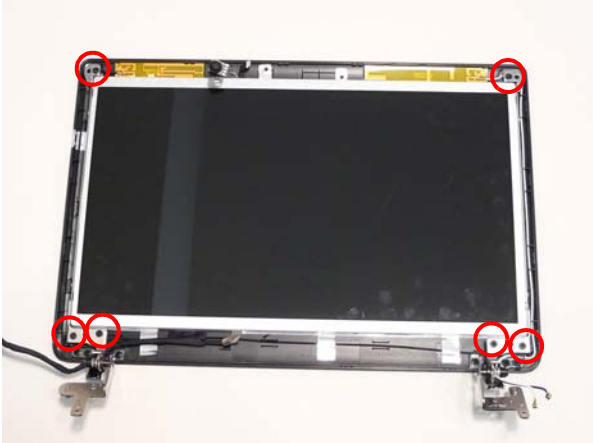

Step	Size	Quantity	Screw Type
LCD Panel	M2*4	6	

- 4. Ensure the Wi-Fi antenna cables are free of the hinges, then remove the LCD Panel from the LCD module.

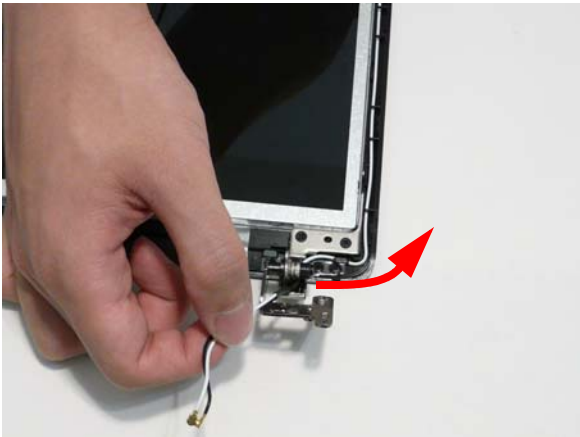

Removing the LCD Brackets

1. See "Removing the LCD Panel" on page 80.
2. Remove the four (4) screws of the LCD brackets.

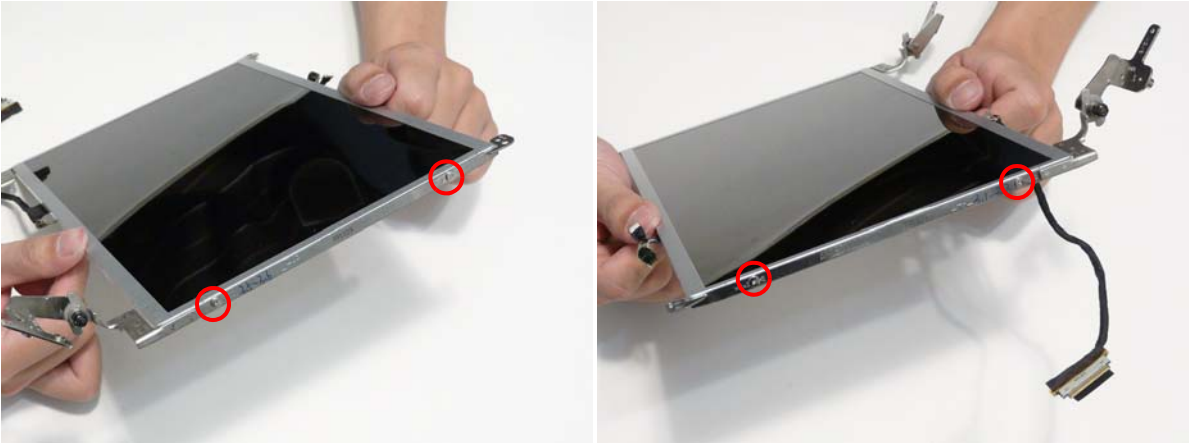

Step	Size	Quantity	Screw Type
LED Panel Brackets	M2*3	4	

Removing the LVDS/Microphone Cable

1. Turn the LCD panel over to expose the rear. Lift the microphone cable as shown to remove it from the LCD panel.

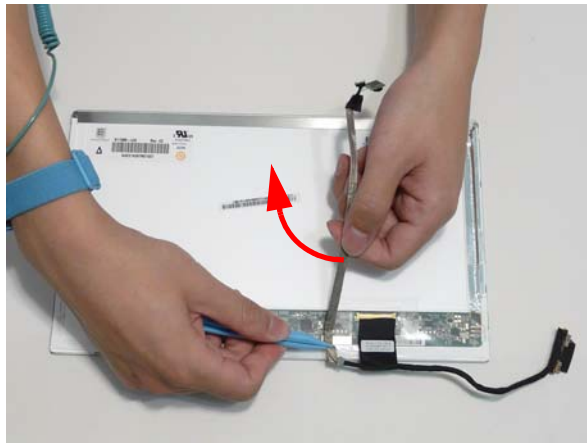

-
2. Lift up the transparent adhesive protector securing the cable to the LCD Panel.

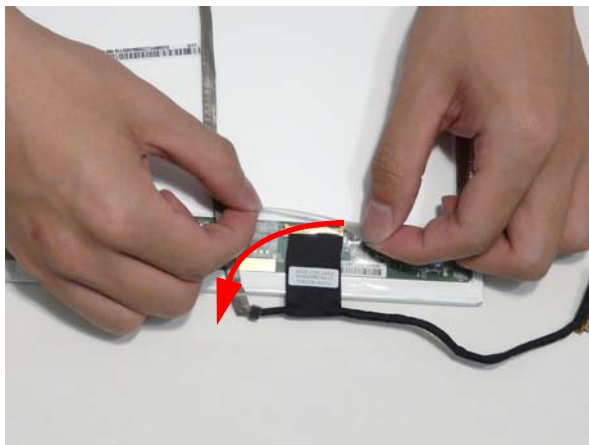

3. Disconnect the cable from the panel connector and lift the FPC cable from the panel.

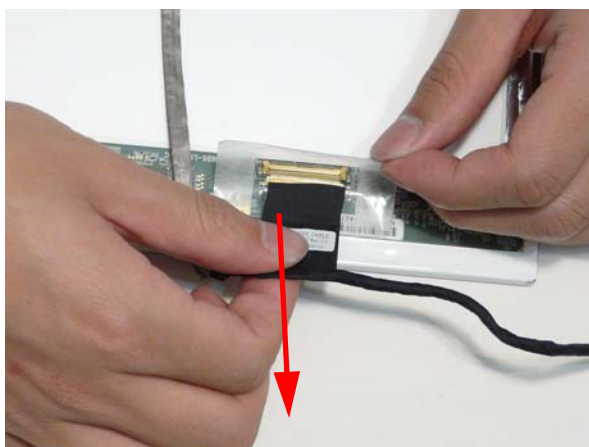

Removing the WLAN Antennas

1. See "Removing the LCD Panel" on page 80.
2. Gently lift the five (5) foil tabs off the black (left) and white (right) 3G cables.



3. Remove the right WLAN antenna cables from the cable retention guides.



4. Disengage the adhesive foil holding the antennas in place. Warming the foil may make it easier to remove. Take care not to damage the antenna.

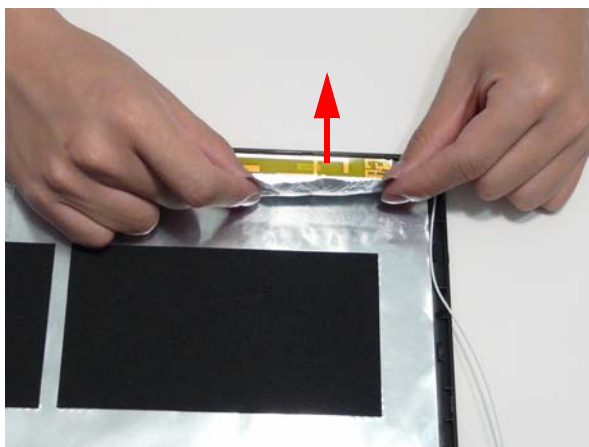

5. Lift the WLAN antennas off the LCD module cover.

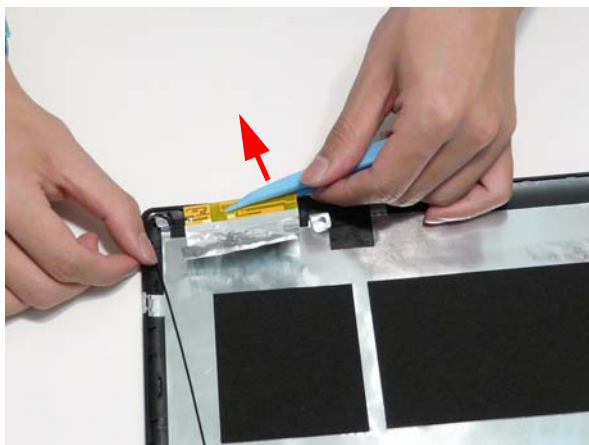

LCD Module Reassembly Procedure

Replacing the WLAN Antennas

1. Replace the left (black cable) and right (white cable) antennas as shown. Press down on the adhesive pads to secure the antennas in place.

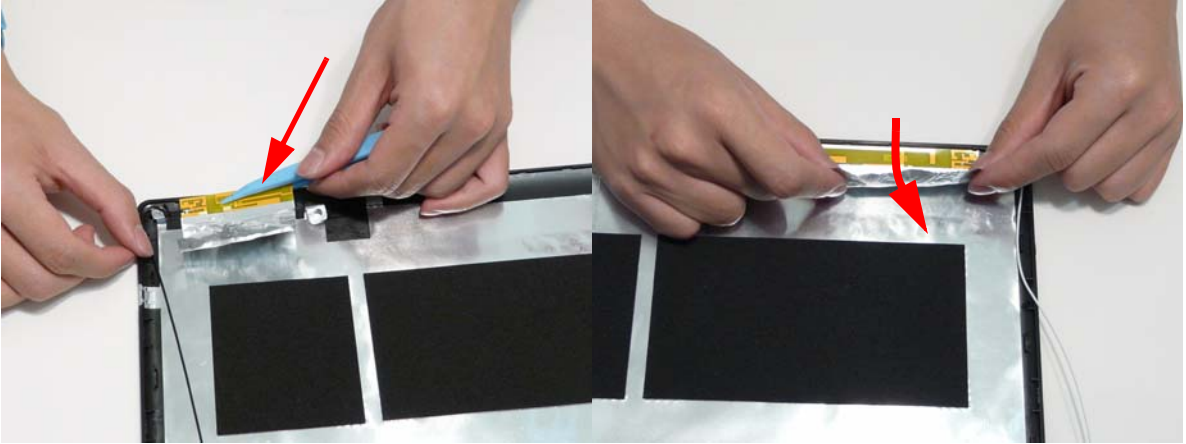

2. Lay the cables along the cable channels.

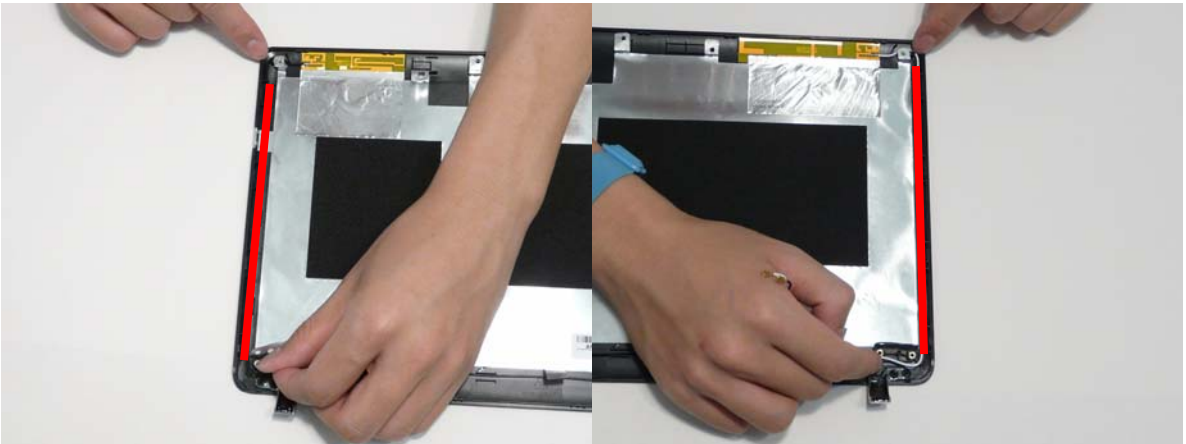

3. Replace the foil tabs over the cables.

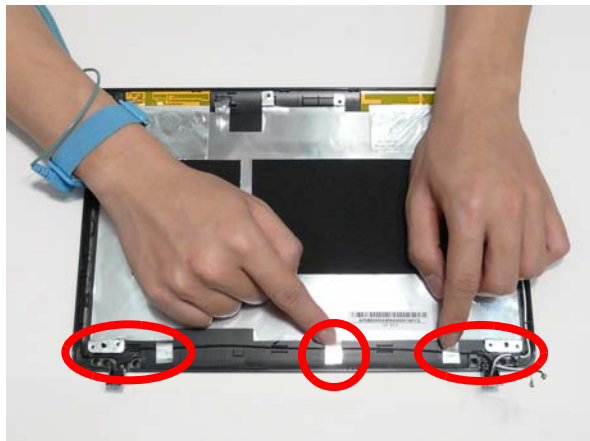

Replacing the LCD/Microphone Cable

1. Replace the LCD cable connector (1) and clear adhesive tape (2).

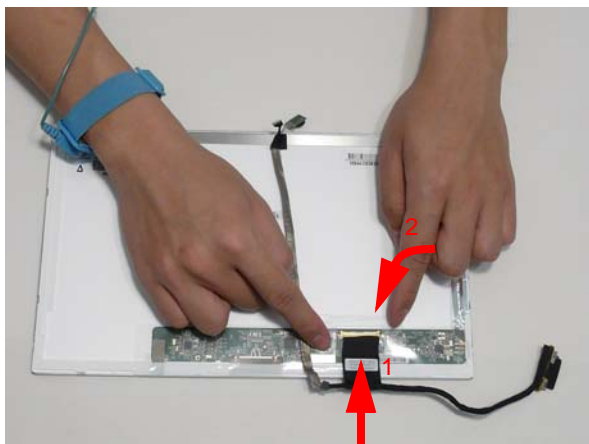

2. Adhere the Microphone/Webcam cable to LCD panel back as shown.

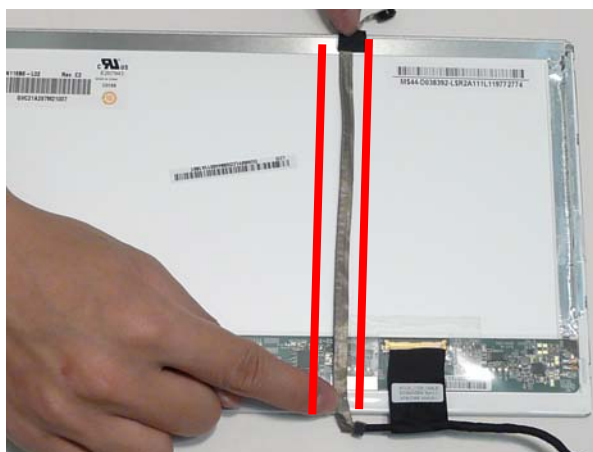

WARNING: Warning: Improper replacement of LCD cable may cause webcam/microphone misalignment.

Replacing the LCD Panel

1. Align the left and right LCD panel brackets with the panel.



2. Replace the four (4) screws.



3. Replace the LCD panel into the LCD module cover.



4. Thread the cables through the left and right hinges.

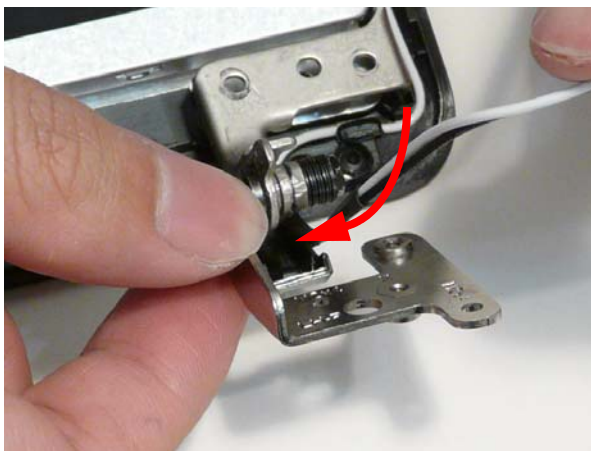

5. Replace the six (6) screws.

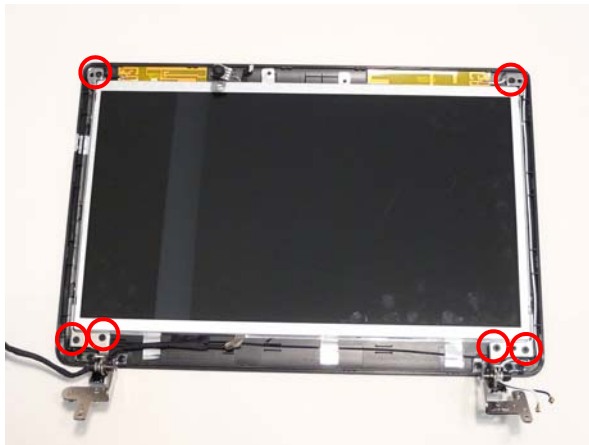

6. Replace the adhesive foil back over the microphone to secure it in place.

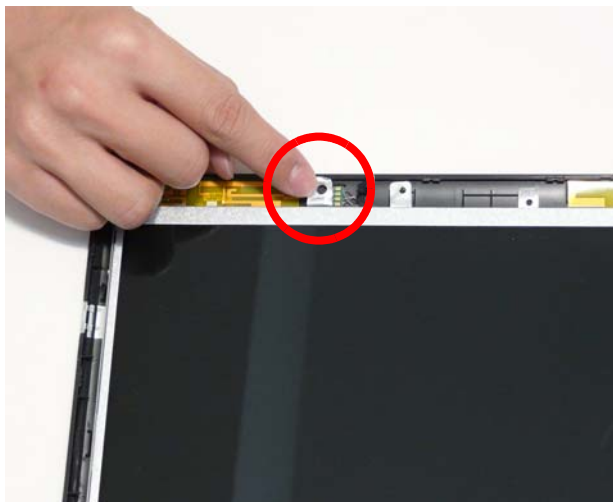

Replacing the Camera Module

1. Align camera module with the guides and press down to secure onto the LCD module cover.

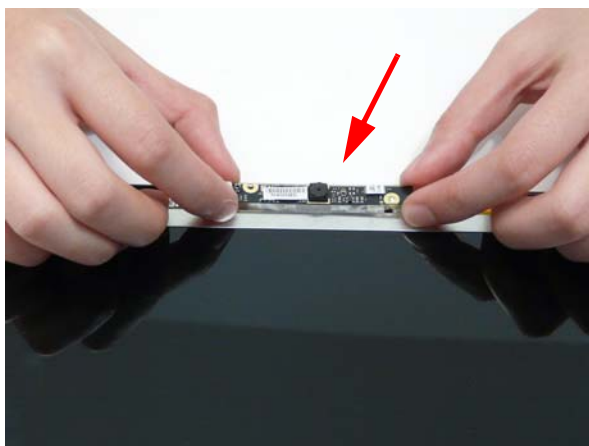

2. Connect the webcam cable.

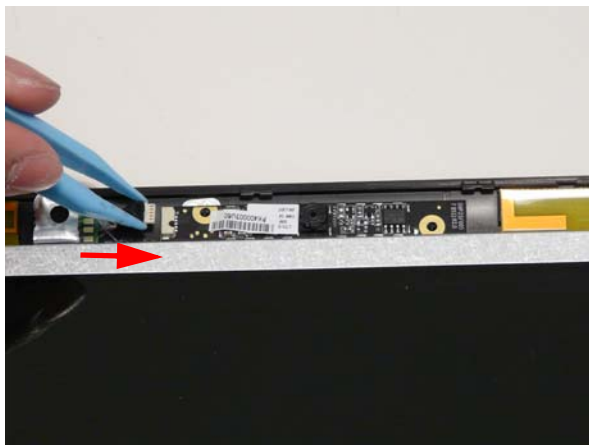

Replacing the LCD Bezel

1. Ensure that the LCD cables pass through the hinge wells and are not trapped by the bezel. Attach the clasp mechanism at the hinges and lower the bezel.

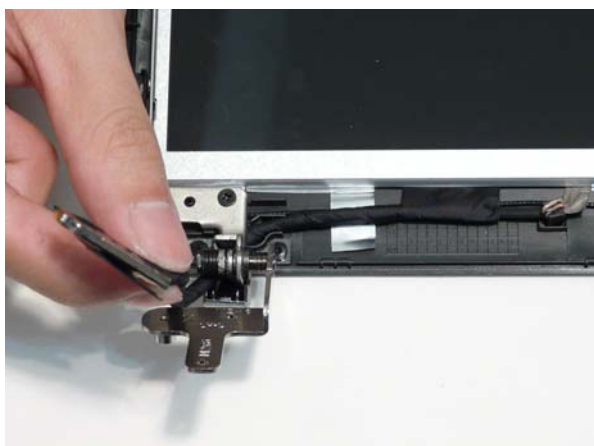

-
2. Press down around the entire perimeter of the bezel until there are no gaps between the bezel and the LCD Module.

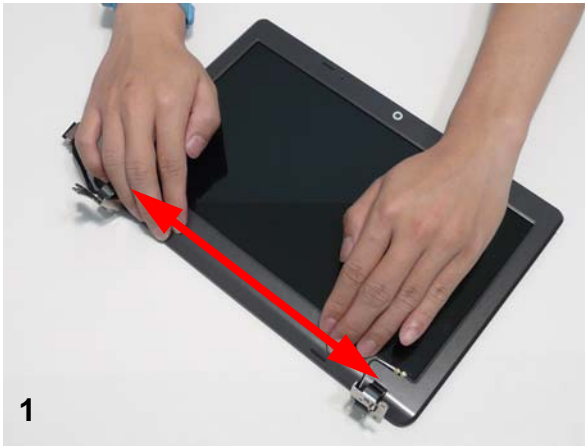

Main Module Reassembly Procedure

Replacing the DC Jack

1. Insert the DC power jack into the chassis.

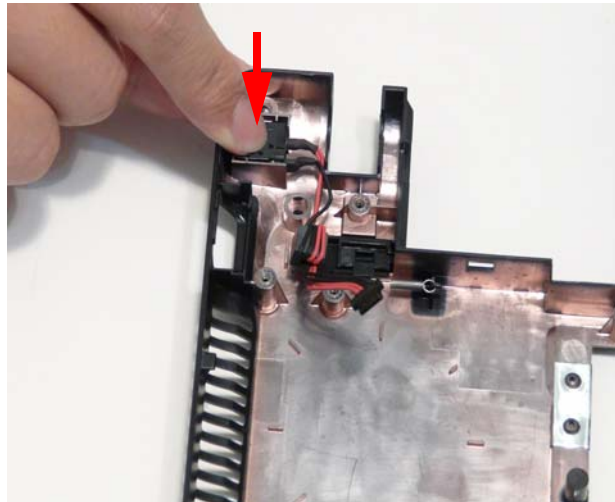

2. Thread the cable through the guides and press the cable bundle into its retainer.

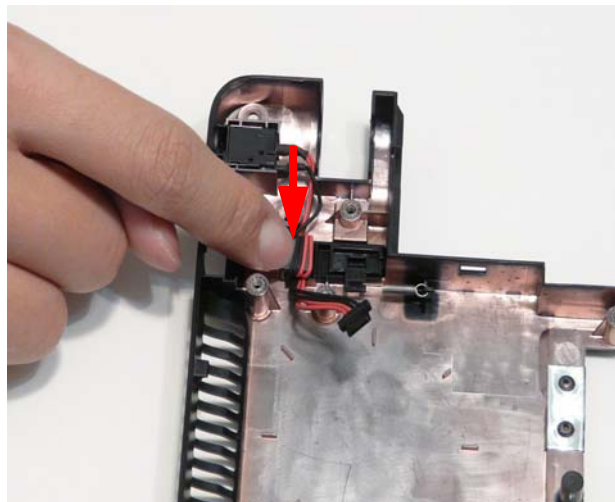

Replacing the VGA Cable

1. Insert the VGA cable into the chassis with the adapter pointed down on an angle as indicated in the photograph.

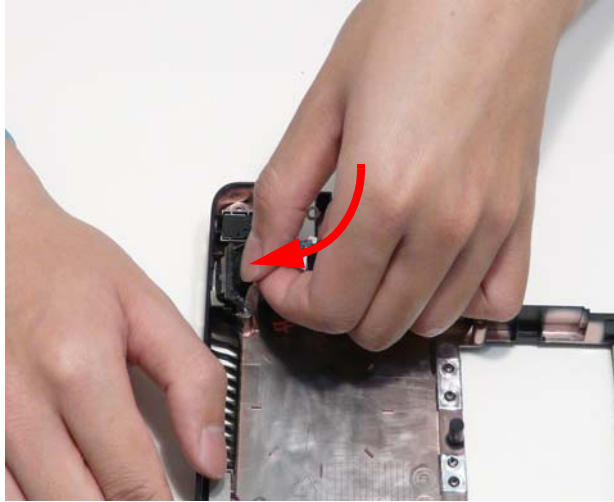

2. Press down on the back of the adapter and snap it into place.

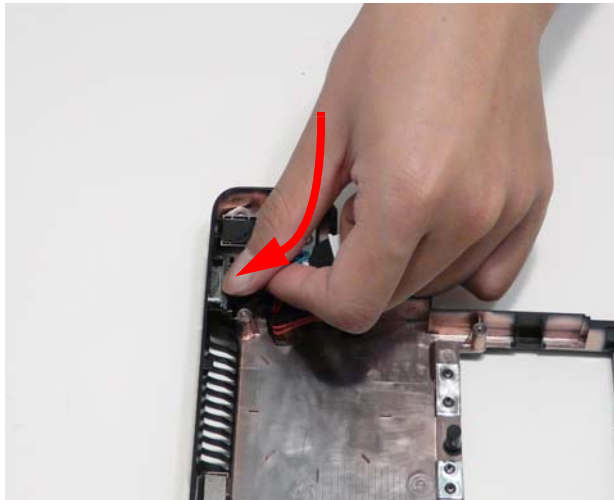

Replacing the LCD Module

1. Set LCD hinges back onto the guides on the chassis. Ensure the wiring for the DC jack and VGA cable are under the left hinge (see green arrows in step 2).

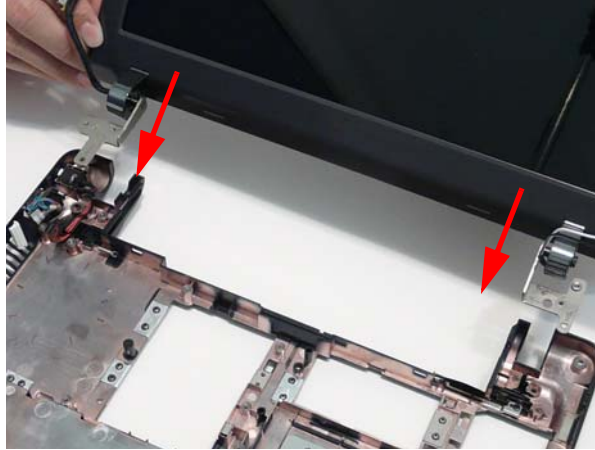

2. Replace the four (4) screws on the LCD hinges ensuring the grounding wire (1) is attached as indicated.

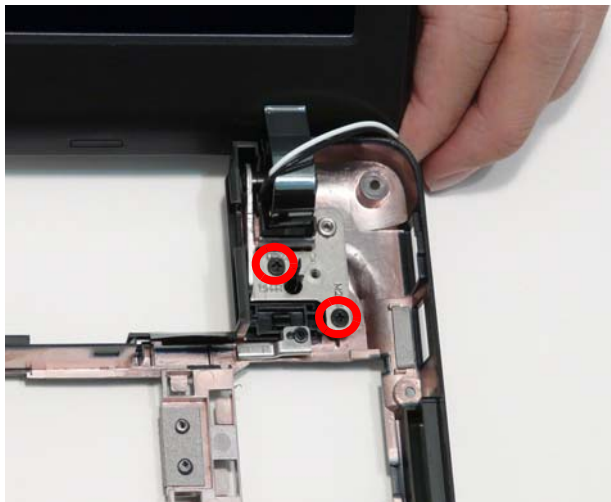
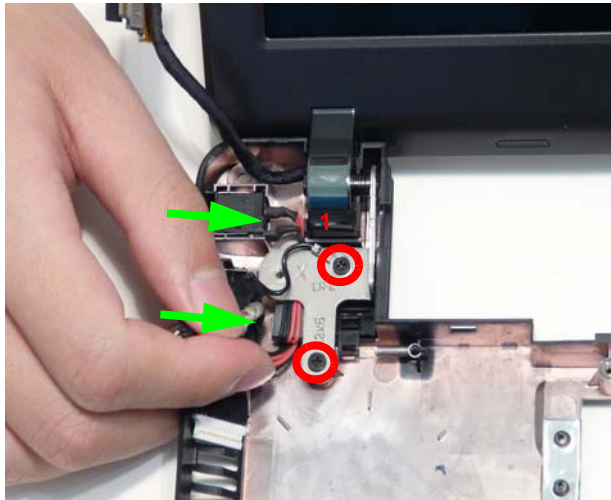

Replacing the Wi-Fi Switch Board

1. Reconnect the Wi-Fi switch board FFC.

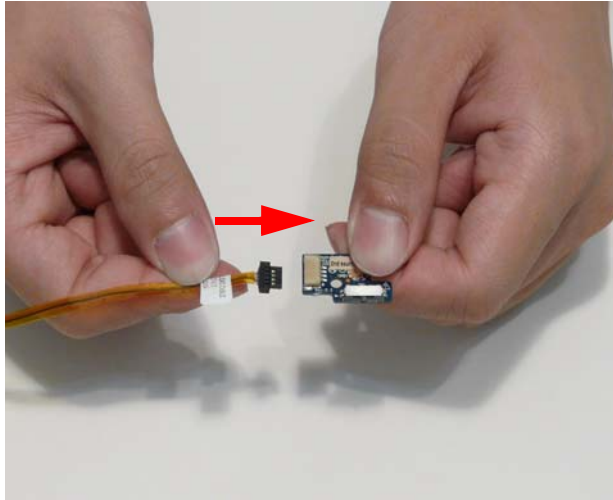

2. Slide the Wi-Fi switch board over its guide pin in the chassis and insert the slider (red circle) into the guides located on the chassis as indicated in the second photo below.



NOTE: Ensure the slider (red) is properly inserted into the guides (green) of the Wi-Fi switch.

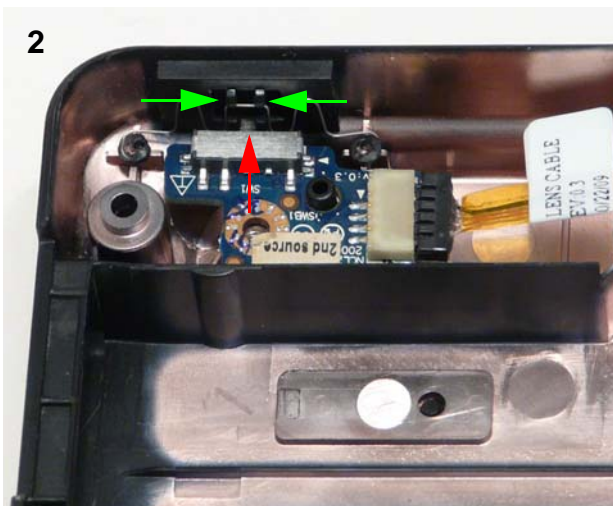

3. Replace the one (1) screw.



4. Replace the FFC and adhere the adhesive tape over the cable.

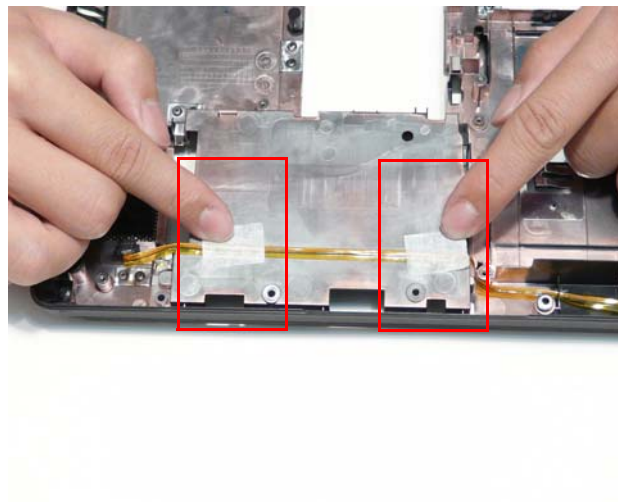

Replacing the Speakers

1. Replace both speaker housings into the chassis.

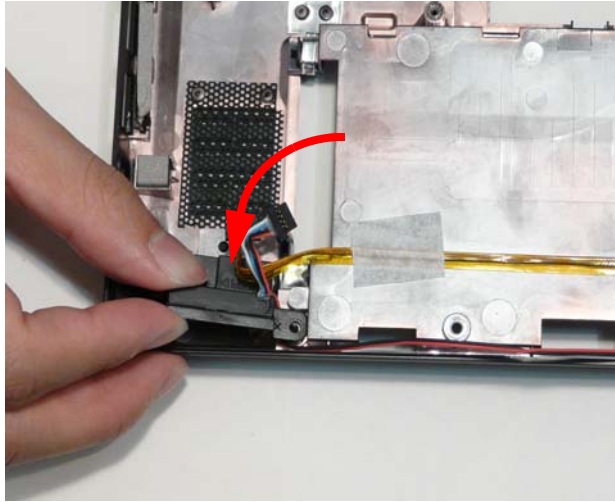

2. Lay the speaker cables under the retention guides.

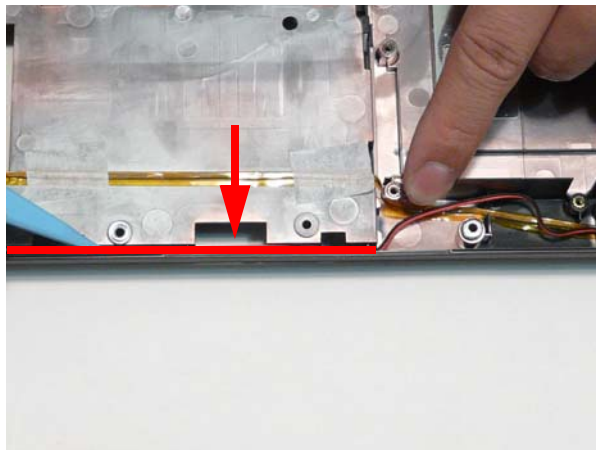

-
3. Replace the two (2) screws and replace the adhesive tape to hold the speaker cable in place.

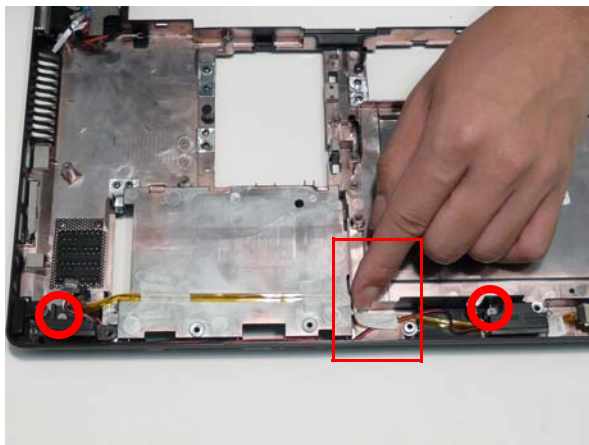

Replacing the I/O Board

1. Place the I/O board into the chassis.



2. Replace the two (2) screws.

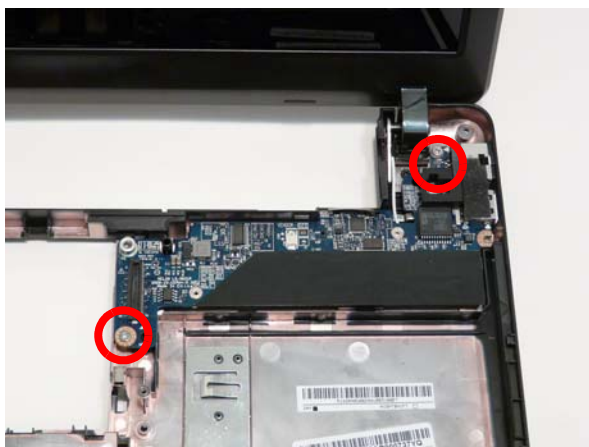

Replacing the Thermal Module

IMPORTANT: Apply a suitable thermal grease (see recommended types below) and ensure all heat pads are in place before replacing the Thermal Module.

The following thermal grease types are approved for use:

- Silmore GP50
- Honeywell PCM45F-SP
- ShinEtsu 7762

The following thermal pads are approved for use:

- Eapus XR-PE

1. Remove all traces of thermal grease from the CPU using a lint-free cloth or cotton swab and Isopropyl Alcohol, Acetone, or other approved cleaning agent.
2. Apply a small amount of thermal grease to the centre of the CPU—there is no need to spread the grease manually, the force used during the installation of the Thermal Module is sufficient.
3. Align the screw holes on the Thermal Module and Mainboard and lower the module into place. Keep the module as level as possible to spread the thermal grease evenly.



4. Tighten the four (4) screws in numerical order: 4, 3, 2 then 1.

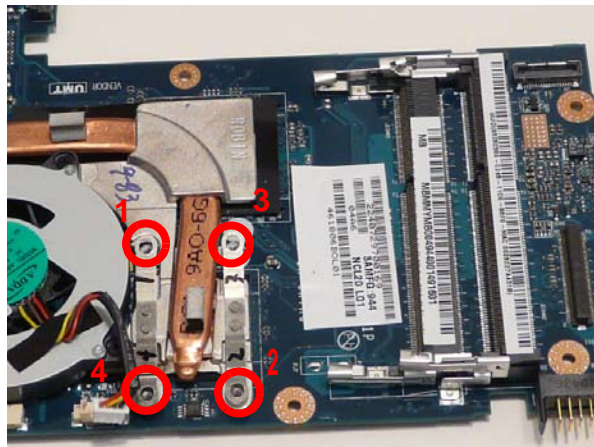

5. Connect the thermal module cable to the mainboard.

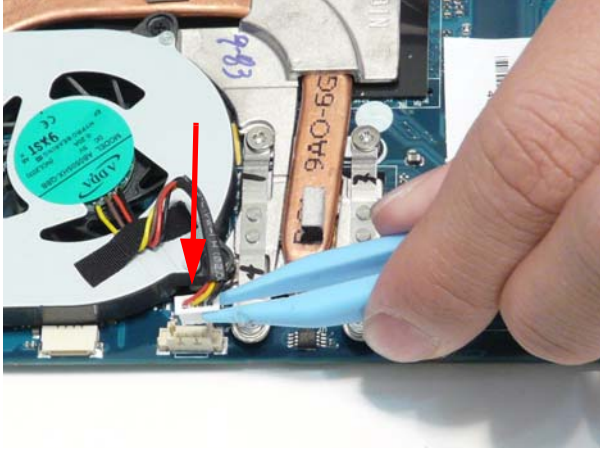

Replacing the Mainboard

1. Before placing the mainboard into the chassis, connect the HDD connector cable to the Main Board.

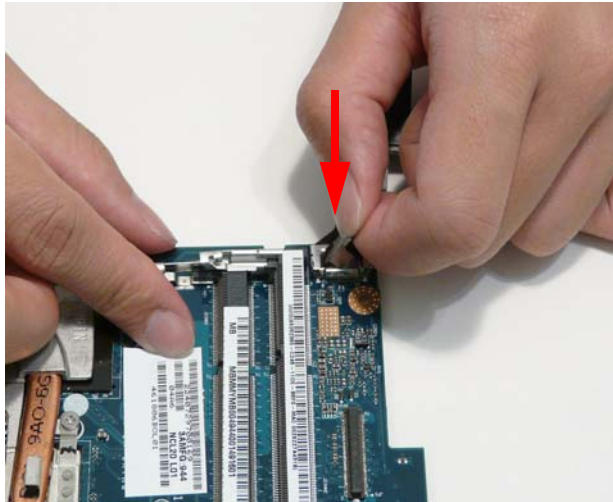

2. Connect the DC power cable from the lower cover to the mainboard.

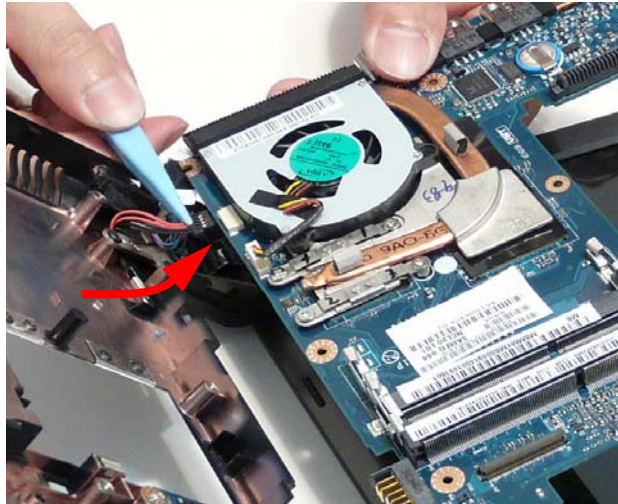

3. Ensure that the Mainboard is face up (the CPU is not visible). Place the Mainboard in the chassis, left side first (1), then rotate it downward into position (2).

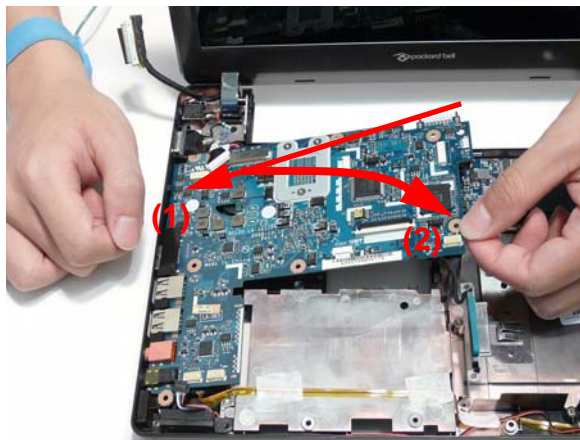

4. Press down on the right side to engage the latch under the mainboard.



5. Replace two (2) HDD connector screws.



6. Connect the LVDS cable.

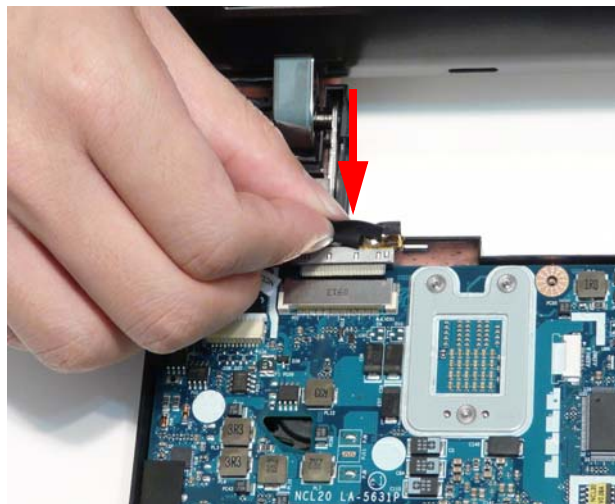

7. Replace the CRT cable.

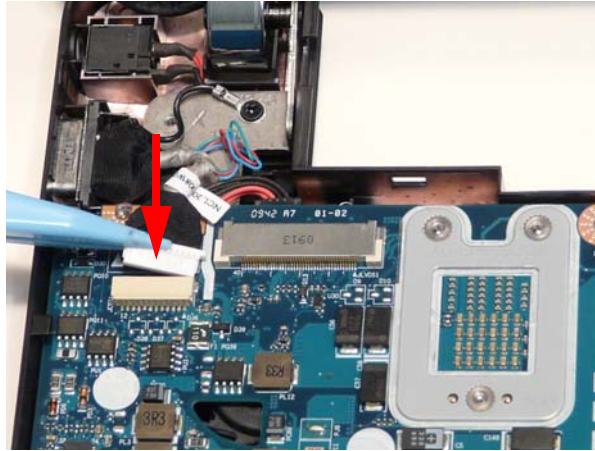

8. Connect the speaker and card reader board cables.

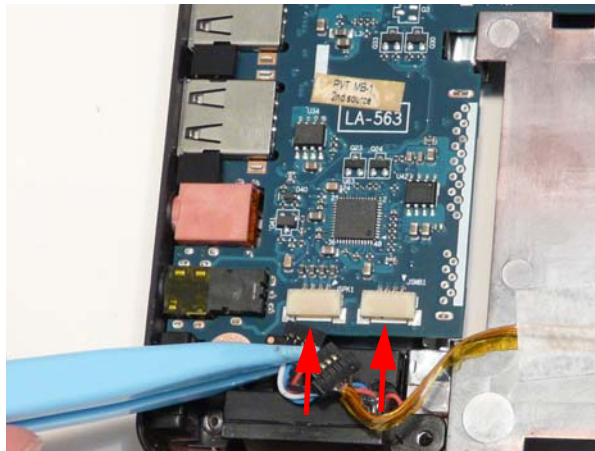

Replacing the Bluetooth Module

1. Connect the Bluetooth cable to the Bluetooth module

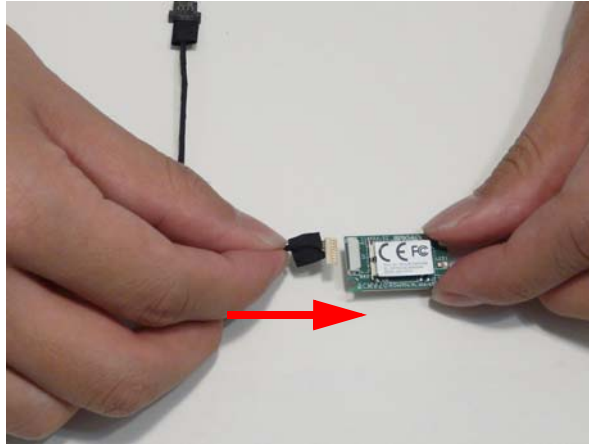

2. Replace the Bluetooth module.

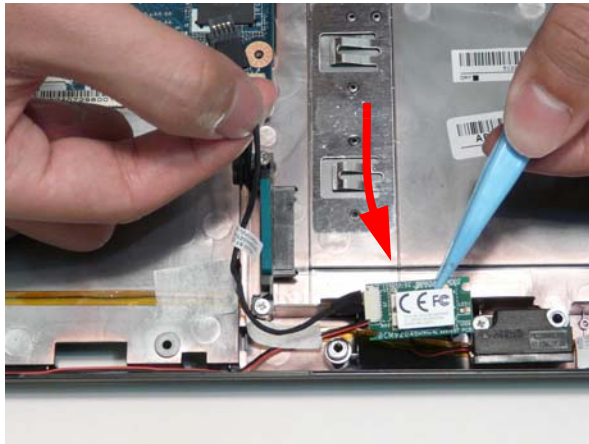

3. Connect the Bluetooth cable to the mainboard.

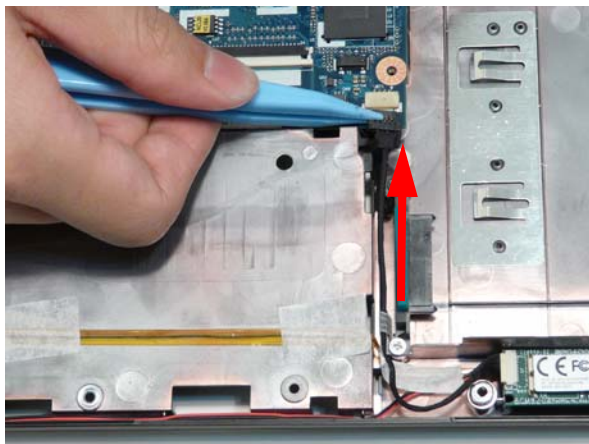

-
4. Lay the Bluetooth cable into the channel to the right of the HDD bay.

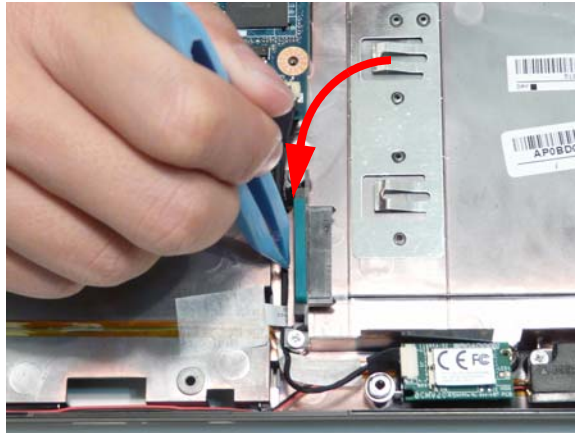

5. Apply adhesive tape to hold the bluetooth cable in place.

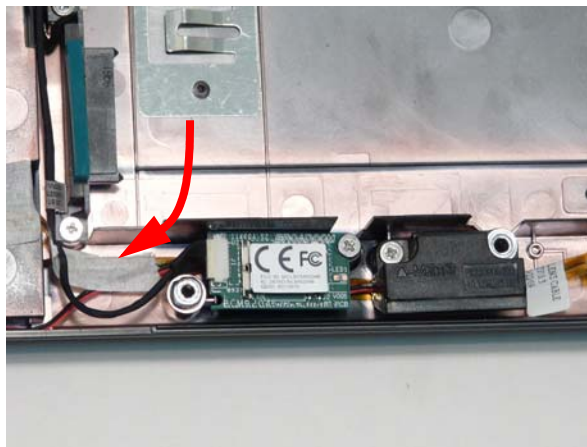

Replacing the Button Board

1. Replace the button board.

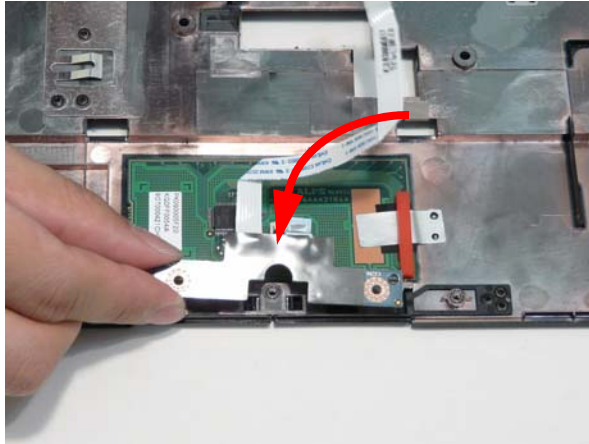

2. Replace the two (2) screws.

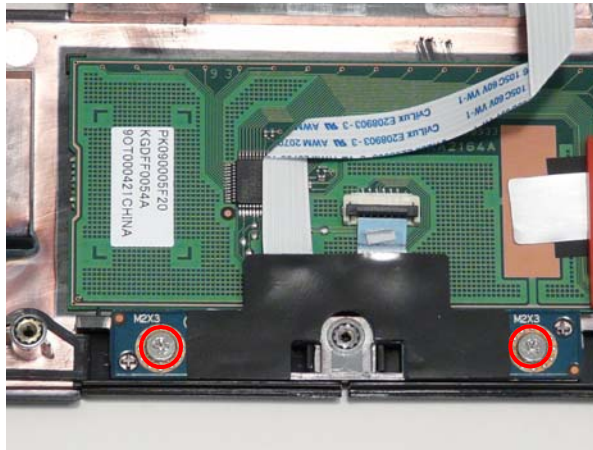

3. Connect the touchpad FFC and lock it into place.

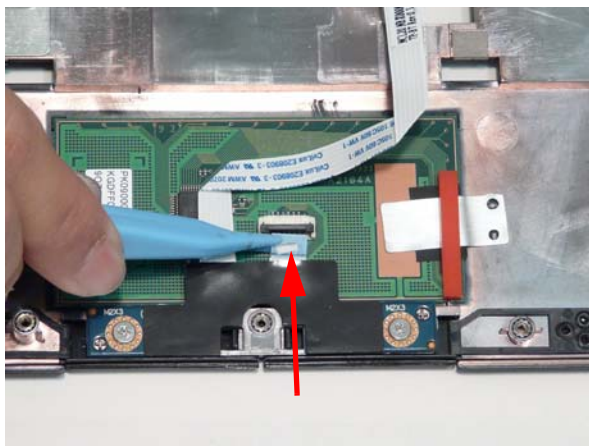

4. Replace the button board FFC and press down to set the adhesive.

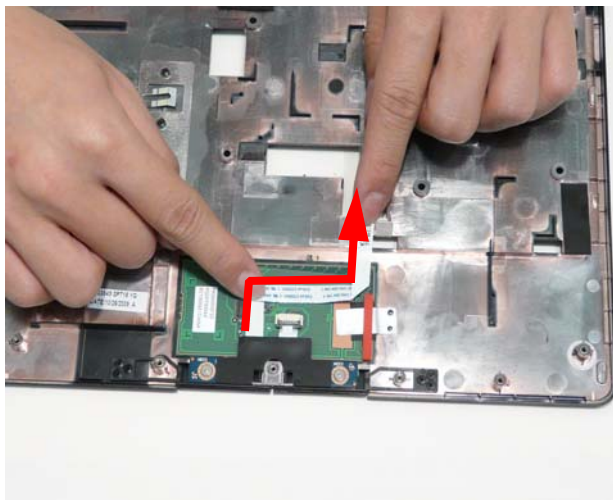

Replacing the Card Reader Board

1. Connect the two (2) FFC cables to the Card Reader Board.

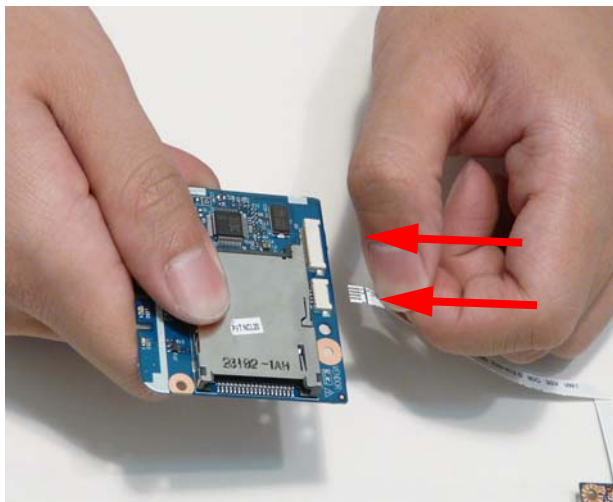

2. Replace the Card Reader board into the upper case.

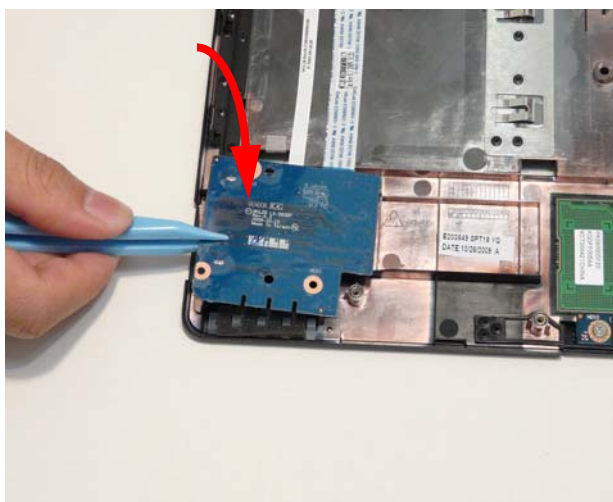

3. Replace the ODD Eject module onto the guide pin and into place.



4. Replace one (1) screw to secure the ODD Eject board and two (2) screws to the Card Reader Board.

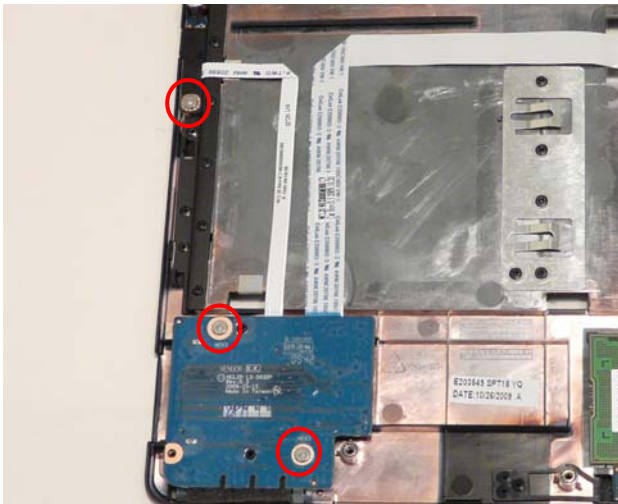

5. Attach the adhesive plastic covering the Card Reader and ODD Eject FFCs to the upper cover as shown below.

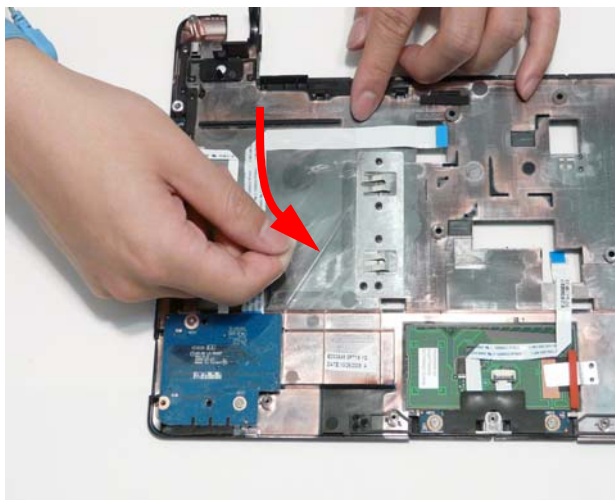

Replacing the LED Board

1. Replace the LED board.

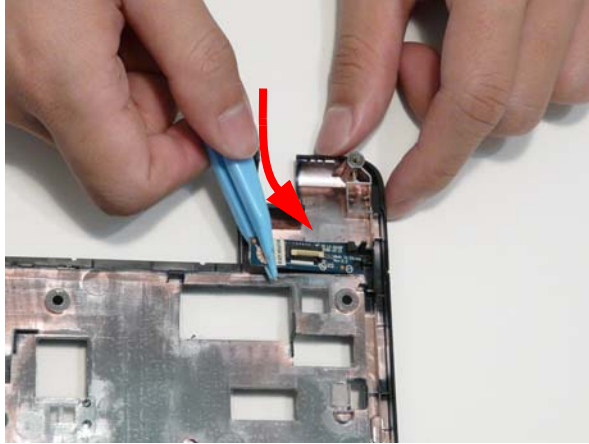

2. Replace the one (1) screw.



3. Connect the LED board FFC.

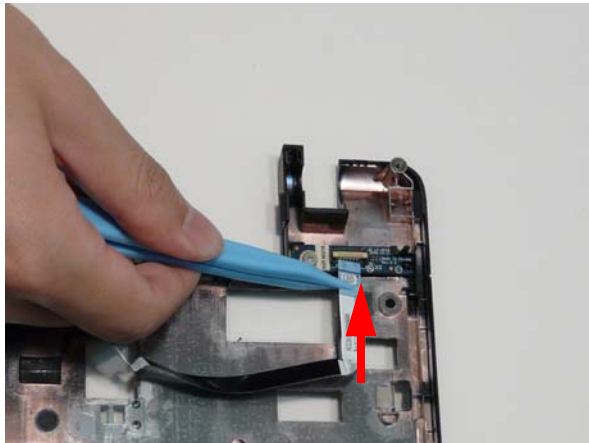

4. Lock the LED board FFC.

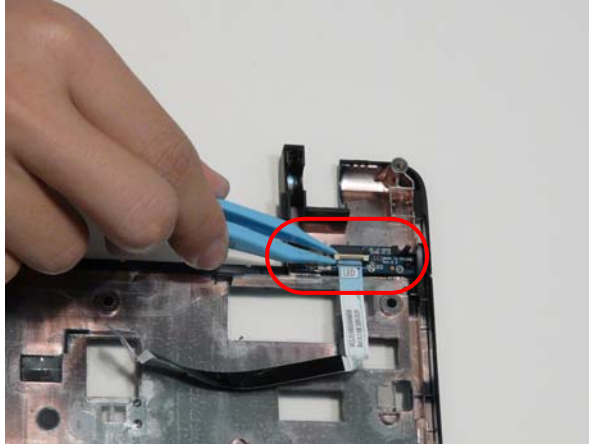

Replacing the Upper Cover

1. Align the bottom edge of the upper cover with the bottom of the chassis.



2. Ensure all wires are tucked under the upper cover then gently lower the upper cover onto the upper cover.



3. Beginning with the bottom edge, press around the edges of the upper cover to snap it into place.

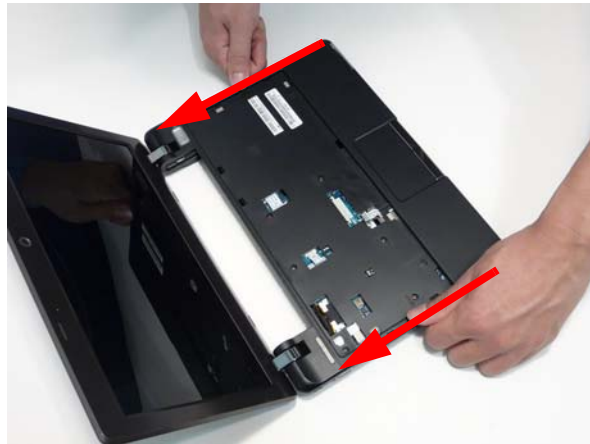
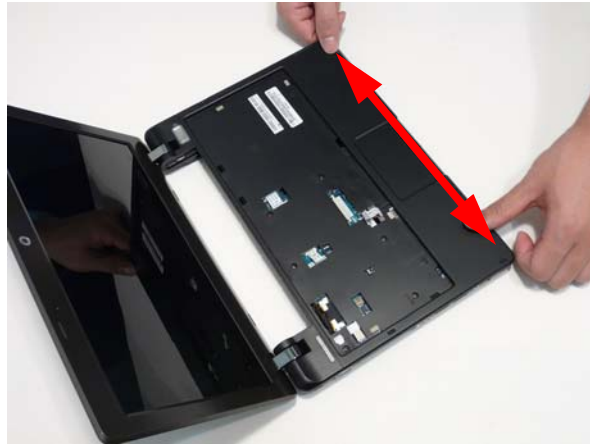

4. Replace the six (6) screws in the upper cover.



5. Turn the computer over and replace three (3) screws in the HD bay.



6. Replace nine (9) screws in the bottom cover.

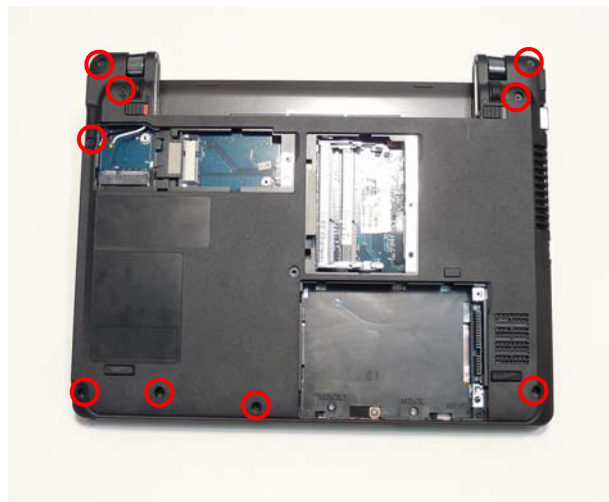

7. Turn the computer over and replace the function board FFC, then replace the I/O board FFC.



8. Replace the button board FFC. Replace the adhesive tape over the button board FFC connector.

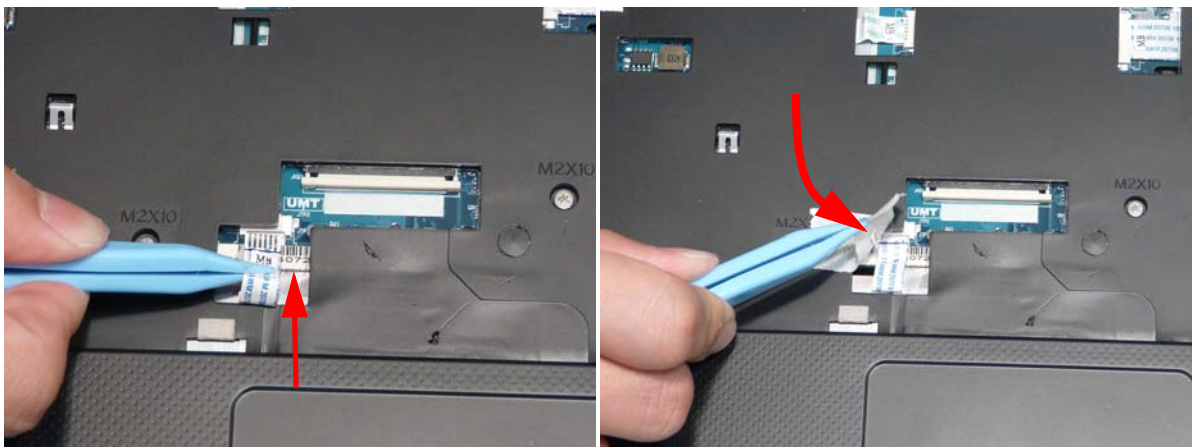

Replacing the Keyboard

1. Connect the keyboard FPC i) and lock it ii).

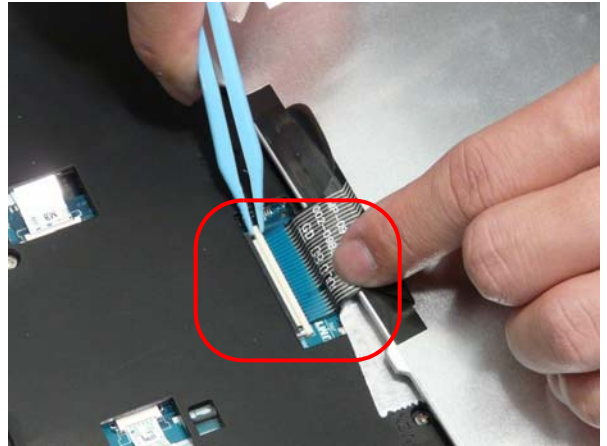
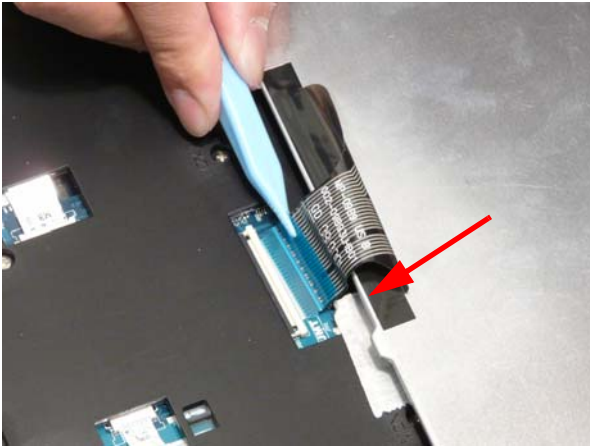

2. Turn the keyboard over into the keyboard bay.



3. Press down on the keyboard to engage all four (4) latches.



Replacing the ODD

1. Replace two (2) screws to attach the ODD bracket to the ODD.



2. Snap the ODD cover onto the front of the ODD.

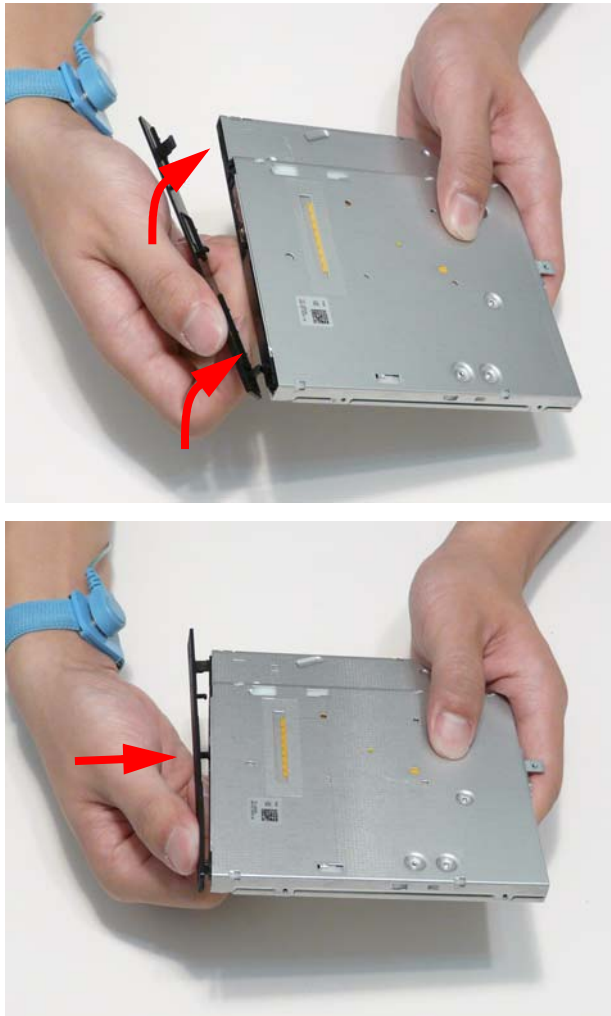

3. Gently slide the ODD back into the chassis.



4. Replace the one (1) screw to secure the ODD module in place.



Replacing the WLAN Module

1. Replace the WLAN module.



2. Replace the one (1) screw.

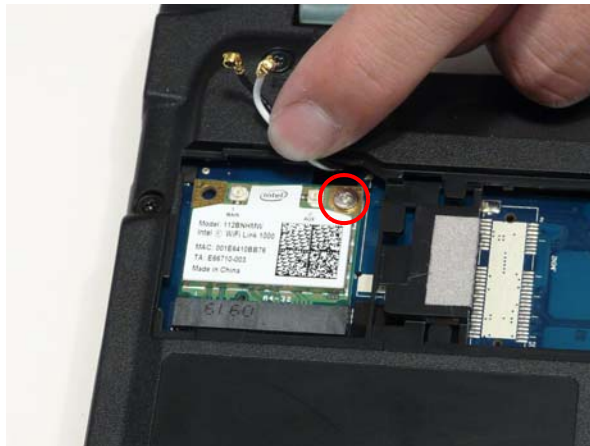

3. Replace the two connectors. Cable placement is **Black** to the **MAIN** terminal (left) and **White** to the **AUX** terminal (right).



Replacing the Hard Disk Drive

1. Replace the HDD into the carrier.

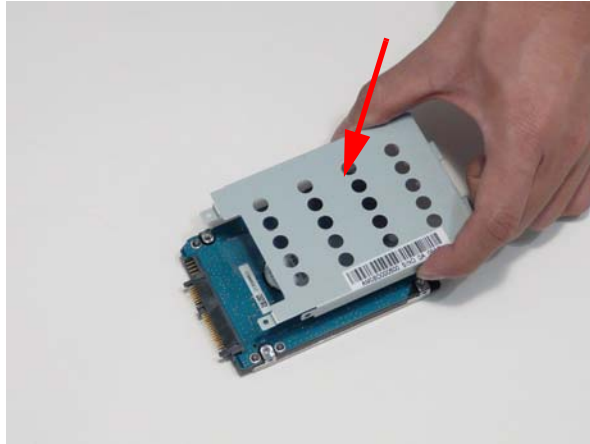

2. Replace the four (4) screws, two (2) on each side.

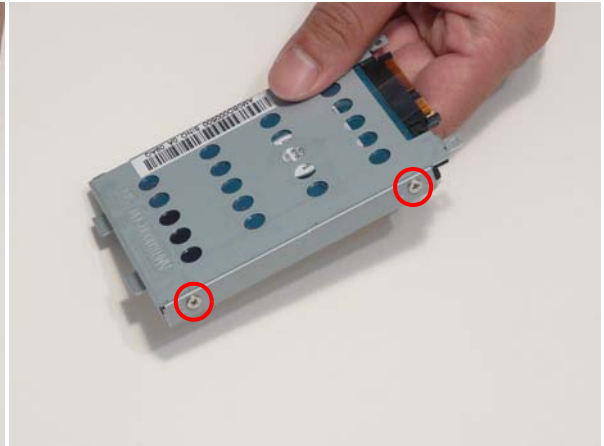
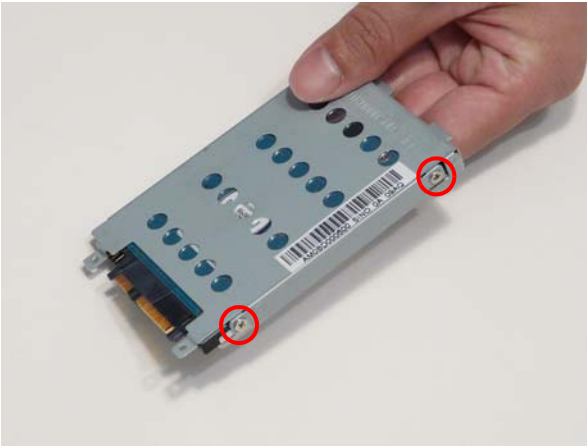

3. Insert the HDD module into the HDD bay, back end (opposite the connectors) first.

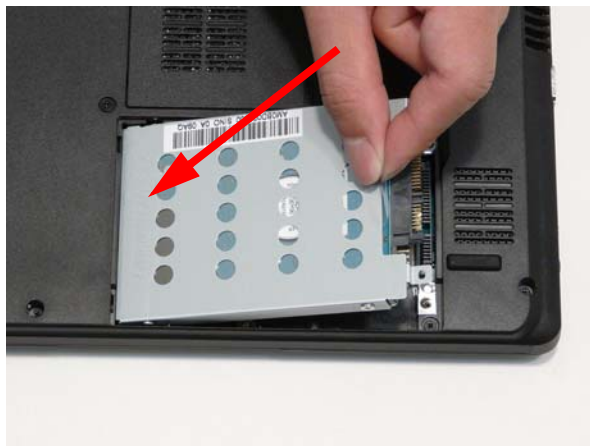

4. Gently push down on the HDD module, ensuring it is properly connected.

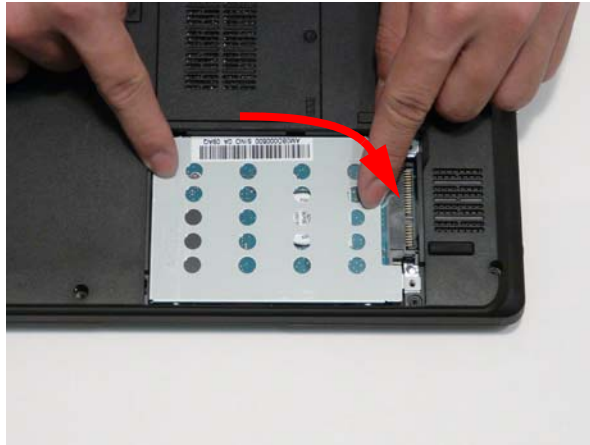

5. Ensure the pull tab is tucked down neatly.

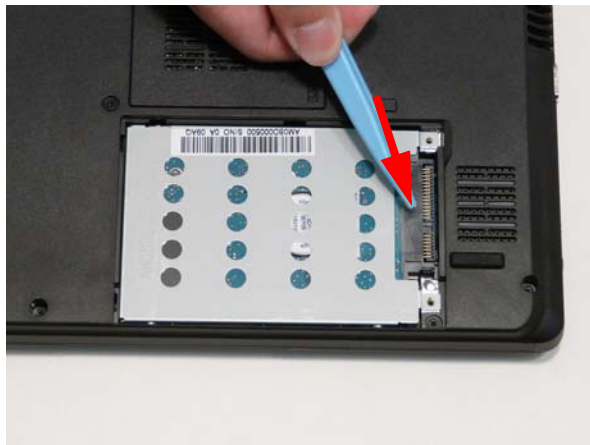

Replacing the DIMM Modules

1. Replace the DIMM module(s), connector end first.



2. Press the DIMM module to lock into place.



Replacing the Lower Covers

1. Replace the HDD cover by first locating the external edge flanges (1) and then lowering into place (2).

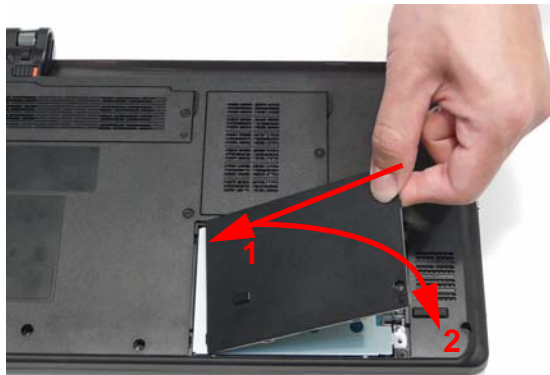

2. Replace the Ram cover by first inserting the internal edge (1) and then lowering into place (2) as shown.

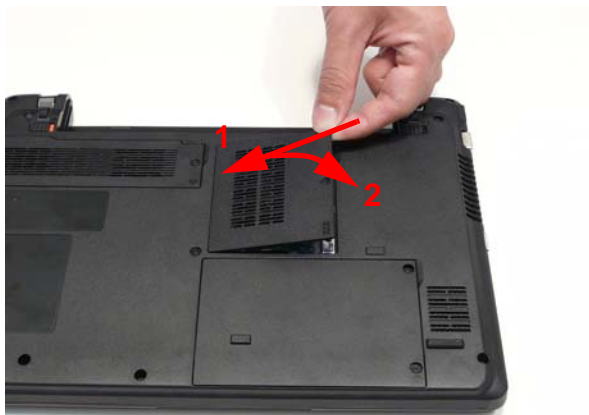

3. Replace the WLAN cover.



4. Tighten the two (2) screws on the HDD cover, one (1) screw on the WLAN cover and the one (1) screw on the DIMM cover.



Replacing the Battery

1. Align battery with the battery bay and slide into place until an audible click sounds.
2. Slide the battery lock to the Lock position, see following image.



Replacing the SD Dummy Card

1. Insert the SD Dummy Card into the slot and push until the card clicks into place and is flush with the casing.



Troubleshooting

Common Problems

Use the following procedure as a guide for computer problems.

NOTE: The diagnostic tests are intended to test only Acer products. Non-Acer products, prototype cards, or modified options can give false errors and invalid system responses.

1. Obtain the failing symptoms in as much detail as possible.
2. Verify the symptoms by attempting to re-create the failure by running the diagnostic test or by repeating the same operation.
3. Use the following table with the verified symptom to determine which page to go to.

Symptoms (Verified)	Go To
Power On Issue	Page 122
No Display Issue	Page 123
LCD Failure	Page 125
Internal Keyboard Failure	Page 125
TouchPad Failure	Page 126
Internal Speaker Failure	Page 126
Internal Microphone Failure	Page 128
WLAN Failure	Page 130
Thermal Unit Failure	Page 131
Other Functions Failure	Page 132
Intermittent Failures	Page 132
Undermined Failures	Page 132

4. If the Issue is still not resolved, see "Online Support Information" on page 167.

Power On Issue

If the system doesn't power on, perform the following actions one at a time to correct the problem. Do not replace a non-defective FRUs:

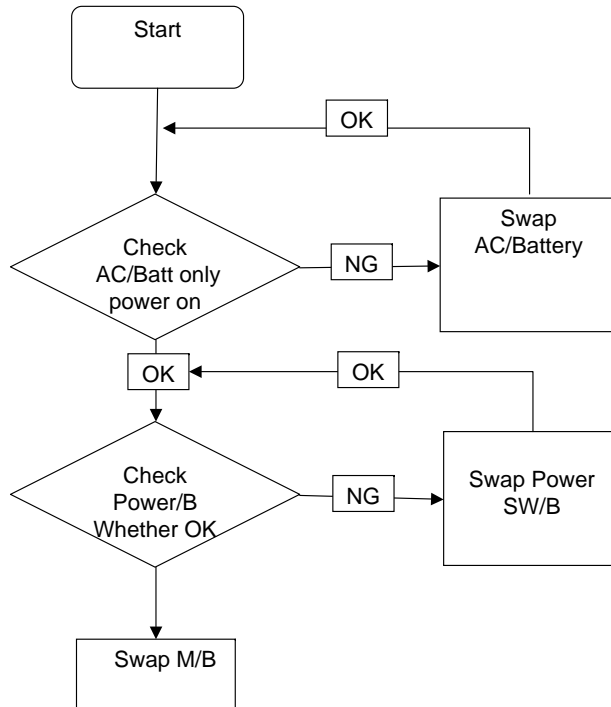

Computer Shutdown Intermittently

If the system powers off at intervals, perform the following actions one at a time to correct the problem.

1. Check the power cable is properly connected to the computer and the electrical outlet.
2. Remove any extension cables between the computer and the outlet.
3. Remove any surge protectors between the computer and the electrical outlet. Plug the computer directly into a known good electrical outlet.
4. Disconnect the power and open the casing to check the Thermal Unit (see "Thermal Unit Failure" on page 131) and fan airways are free of obstructions.
5. Remove all external and non-essential hardware connected to the computer that are not necessary to boot the computer to the failure point.
6. Remove any recently installed software.
7. If the Issue is still not resolved, see "Online Support Information" on page 167.

No Display Issue

If the **Display** doesn't work, perform the following actions one at a time to correct the problem. Do not replace a non-defective FRUs:

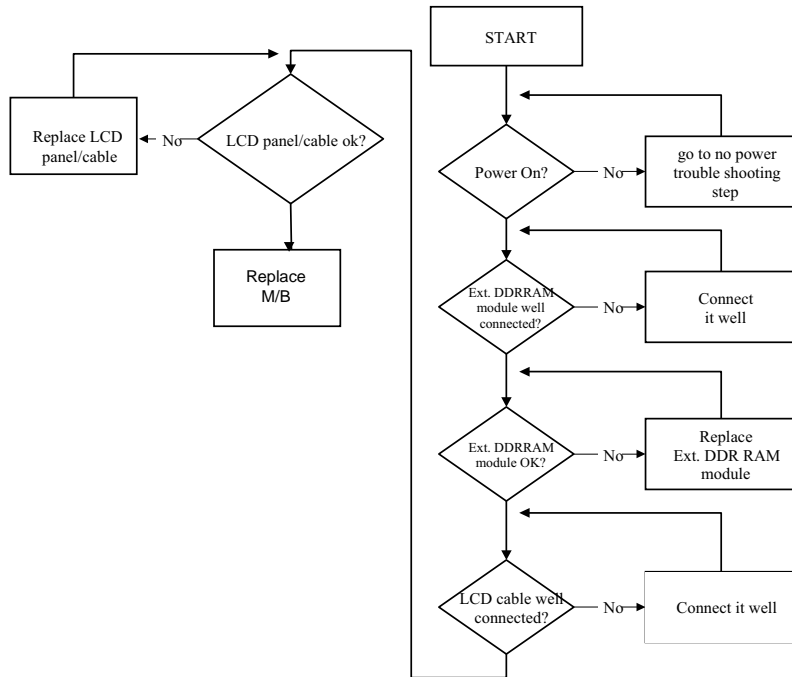

No POST or Video

If the POST or video doesn't display, perform the following actions one at a time to correct the problem.

1. Make sure that the internal display is selected. On this notebook model, switching between the internal display and the external display is done by pressing **Fn+F5**. Reference Product pages for specific model procedures.
2. Make sure the computer has power by checking at least one of the following occurs:
 - Fans start up
 - Status LEDs light up

If there is no power, see “Power On Issue” on page 122.

3. Drain any stored power by removing the power cable and battery and holding down the power button for 10 seconds. Reconnect the power and reboot the computer.
4. Connect an external monitor to the computer and switch between the internal display and the external display is by pressing **Fn+F5** (on this model).

If the POST or video appears on the external display, see “LCD Failure” on page 125.

5. Disconnect power and all external devices including port replicators or docking stations. Remove any memory cards and CD/DVD discs. Restart the computer.
If the computer boots correctly, add the devices one by one until the failure point is discovered.
6. Reseat the memory modules.
7. Remove the drives (see “Disassembly Process” on page 38).
8. If the Issue is still not resolved, see “Online Support Information” on page 167.

Abnormal Video Display

If video displays abnormally, perform the following actions one at a time to correct the problem.

1. Reboot the computer.
2. If permanent vertical/horizontal lines or dark spots display in the same location, the LCD is faulty and should be replaced. See “Disassembly Process” on page 38.
3. If extensive pixel damage is present (different colored spots in the same locations on the screen), the LCD is faulty and should be replaced. See “Disassembly Process” on page 38.
4. Adjust the brightness to its highest level. See the User Manual for instructions on adjusting settings.
NOTE: Ensure that the computer is not running on battery alone as this may reduce display brightness.
If the display is too dim at the highest brightness setting, the LCD is faulty and should be replaced. See “Disassembly Process” on page 38.
5. Check the display resolution is correctly configured:
 - a. Minimize or close all Windows.
 - b. If display size is only abnormal in an application, check the view settings and control/mouse wheel zoom feature in the application.
 - c. If desktop display resolution is not normal, right-click on the desktop and select **Personalize**→ **Display Settings**.
 - d. Click and drag the Resolution slider to the desired resolution.
 - e. Click **Apply** and check the display. Readjust if necessary.
6. Roll back the video driver to the previous version if updated.
7. Remove and reinstall the video driver.
8. Check the Device Manager to determine that:
 - The device is properly installed. There are no red Xs or yellow exclamation marks.
 - There are no device conflicts.
 - No hardware is listed under Other Devices.
9. If the Issue is still not resolved, see “Online Support Information” on page 167.
10. Run the Windows Memory Diagnostic from the operating system DVD and follow the onscreen prompts.
11. If the Issue is still not resolved, see “Online Support Information” on page 167.

Random Loss of BIOS Settings

If the computer is experiencing intermittent loss of BIOS information, perform the following actions one at a time to correct the problem.

1. If the computer is more than one year old, replace the CMOS battery.
2. Run a complete virus scan using up-to-date software to ensure the computer is virus free.
3. If the computer is experiencing HDD or ODD BIOS information loss, disconnect and reconnect the power and data cables between devices.
If the BIOS settings are still lost, replace the cables.
4. If HDD information is missing from the BIOS, the drive may be defective and should be replaced.
5. Replace the Motherboard.
6. If the Issue is still not resolved, see “Online Support Information” on page 167.

LCD Failure

If the **LCD** fails, perform the following actions one at a time to correct the problem. Do not replace a non-defective FRUs:

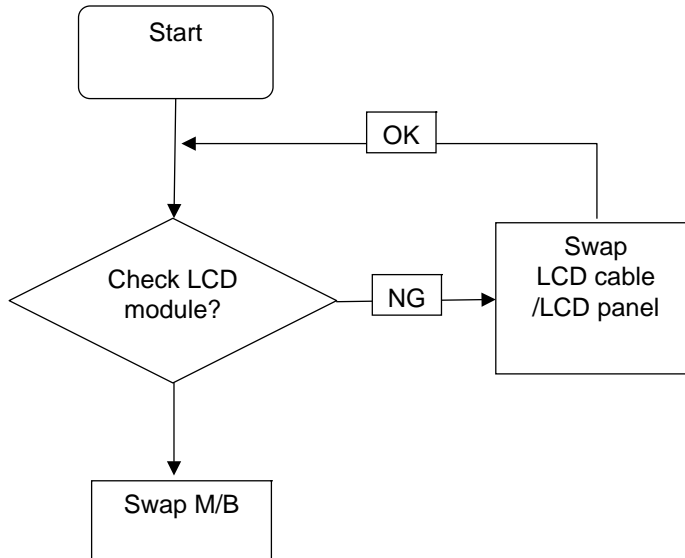

Built-In Keyboard Failure

If the built-in **Keyboard** fails, perform the following actions one at a time to correct the problem. Do not replace a non-defective FRUs:

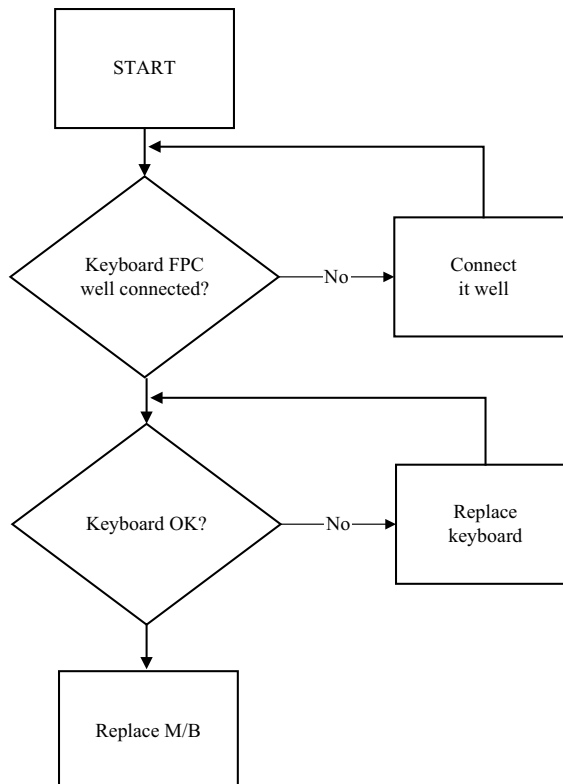

TouchPad Failure

If the **TouchPad** doesn't work, perform the following actions one at a time to correct the problem. Do not replace a non-defective FRUs:

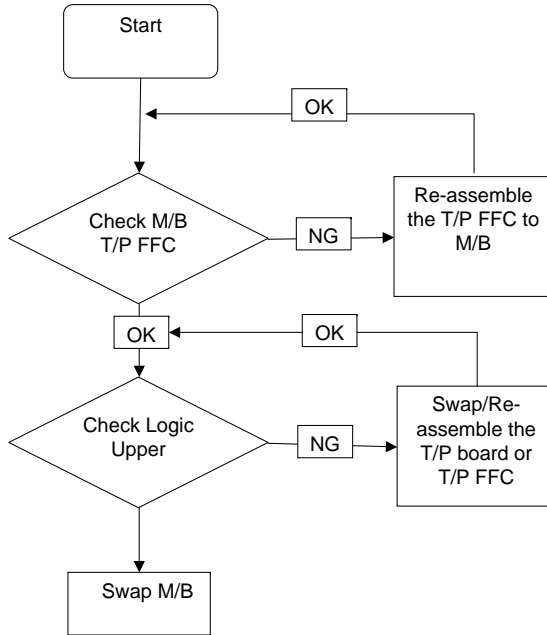

Internal Speaker Failure

If the internal **Speakers** fail, perform the following actions one at a time to correct the problem. Do not replace a non-defective FRUs:

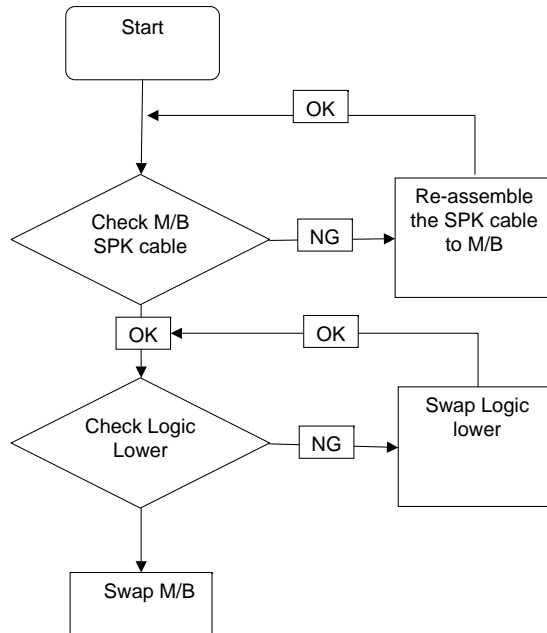

Sound Problems

If sound problems are experienced, perform the following actions one at a time to correct the problem.

1. Reboot the computer.
2. Navigate to **Start** → **Control Panel** → **System and Maintenance** → **System** → **Device Manager**. Check the Device Manager to determine that:
 - The device is properly installed.
 - There are no red Xs or yellow exclamation marks.
 - There are no device conflicts.
 - No hardware is listed under Other Devices.
3. Roll back the audio driver to the previous version, if updated recently.
4. Remove and reinstall the audio driver.
5. Ensure that all volume controls are set mid range:
 - a. Click the volume icon on the taskbar and drag the slider to 50. Ensure that the volume is not muted.
 - b. Click Mixer to verify that other audio applications are set to 50 and not muted.
6. Navigate to **Start** → **Control Panel** → **Hardware and Sound** → **Sound**. Ensure that Speakers are selected as the default audio device (green check mark).

NOTE: If Speakers does not show, right-click on the **Playback** tab and select **Show Disabled Devices** (clear by default).
7. Select Speakers and click **Configure** to start **Speaker Setup**. Follow the onscreen prompts to configure the speakers.
8. Remove and recently installed hardware or software.
9. Restore system and file settings from a known good date using **System Restore**.

If the issue is not fixed, repeat the preceding steps and select an earlier time and date.
10. Reinstall the Operating System.
11. If the Issue is still not resolved, see “Online Support Information” on page 167.

Internal Microphone Failure

If the internal **Microphone** fails, perform the following actions one at a time to correct the problem. Do not replace a non-defective FRUs:

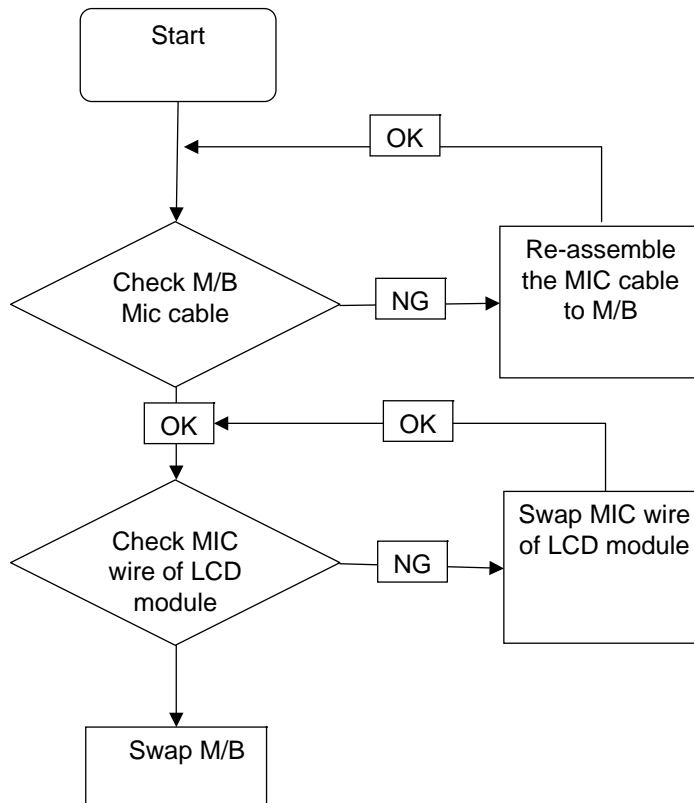

Microphone Problems

If internal or external **Microphones** do not operate correctly, perform the following actions one at a time to correct the problem.

1. Check that the microphone is enabled. Navigate to **Start** → **Control Panel** → **Hardware and Sound** → **Sound** and select the **Recording** tab.
2. Right-click on the **Recording** tab and select **Show Disabled Devices** (clear by default).
3. The microphone appears on the **Recording** tab.
4. Right-click on the microphone and select **Enable**.
5. Select the microphone then click **Properties**. Select the **Levels** tab.
6. Increase the volume to the maximum setting and click **OK**.
7. Test the microphone hardware:
 - a. Select the microphone and click **Configure**.
 - b. Select **Set up microphone**.
 - c. Select the microphone type from the list and click **Next**.
 - d. Follow the onscreen prompts to complete the test.
8. If the Issue is still not resolved, see “Online Support Information” on page 167.

HDD Not Operating Correctly

If the **HDD** does not operate correctly, perform the following actions one at a time to correct the problem.

1. Disconnect all external devices.
2. Run a complete virus scan using up-to-date software to ensure the computer is virus free.
3. Run the Windows 7 Startup Repair Utility:
 - a. insert the Windows 7 Operating System DVD in the ODD and restart the computer.
 - b. When prompted, press any key to start to the operating system DVD.
 - c. The **Install Windows** screen displays. Click **Next**.
 - d. Select **Repair your computer**.
 - e. The **System Recovery Options** screen displays. Click **Next**.
 - f. Select the appropriate operating system, and click **Next**.

NOTE: Click **Load Drivers** if controller drives are required.

- g. Select **Startup Repair**.
- h. Startup Repair attempts to locate and resolve issues with the computer.
- i. When complete, click **Finish**.

If an issue is discovered, follow the onscreen information to resolve the problem.

4. Run the Windows Memory Diagnostic Tool. For more information see Windows Help and Support.
5. Restart the computer and press F2 to enter the BIOS Utility. Check the BIOS settings are correct and that CD/DVD drive is set as the first boot device on the Boot menu.
6. Ensure all cables and jumpers on the HDD and ODD are set correctly.
7. Remove any recently added hardware and associated software.
8. Run the Windows Disk Defragmenter. For more information see Windows Help and Support.
9. Run Windows Check Disk by entering **chkdsk /r** from a command prompt. For more information see Windows Help and Support.
10. Restore system and file settings from a known good date using **System Restore**.

If the issue is not fixed, repeat the preceding steps and select an earlier time and date.
11. Replace the HDD. See "Disassembly Process" on page 38.

USB Failure

If the USB fails, perform the following actions one at a time to correct the problem. Do not replace a non-defective FRU:

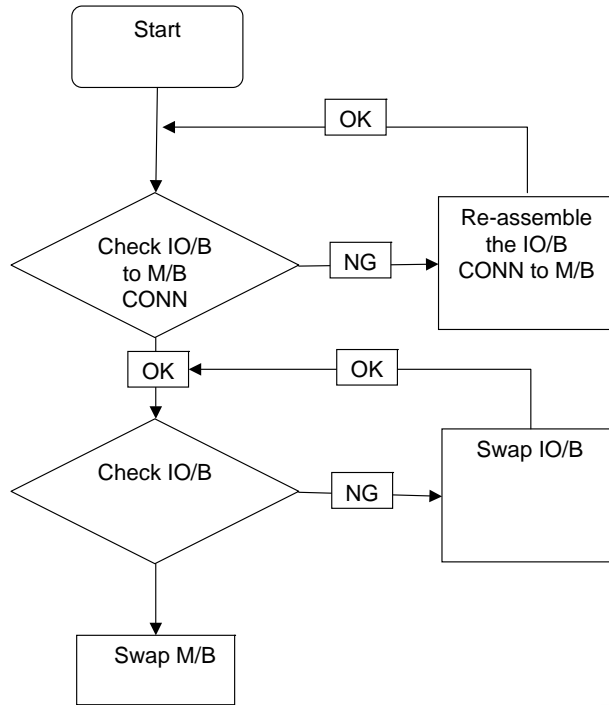

Wireless Function Failure

If the **WLAN** fails, perform the following actions one at a time to correct the problem. Do not replace a non-defective FRUs:

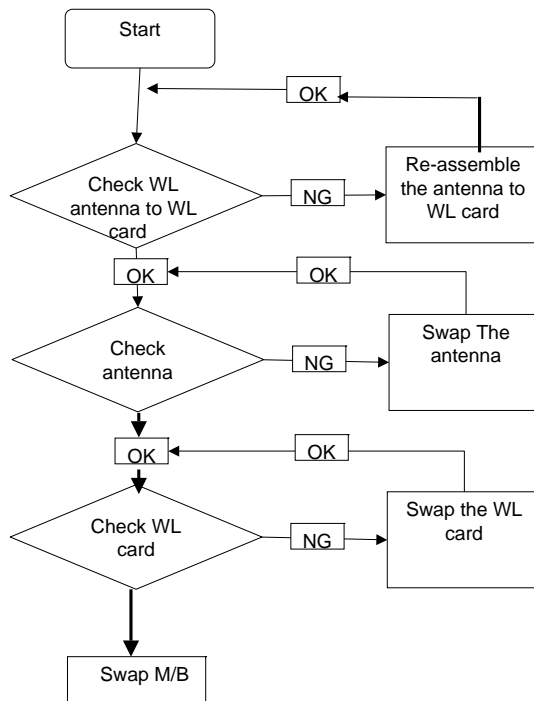

Thermal Unit Failure

If the **Thermal Unit** fails, perform the following actions one at a time to correct the problem. Do not replace a non-defective FRUs:

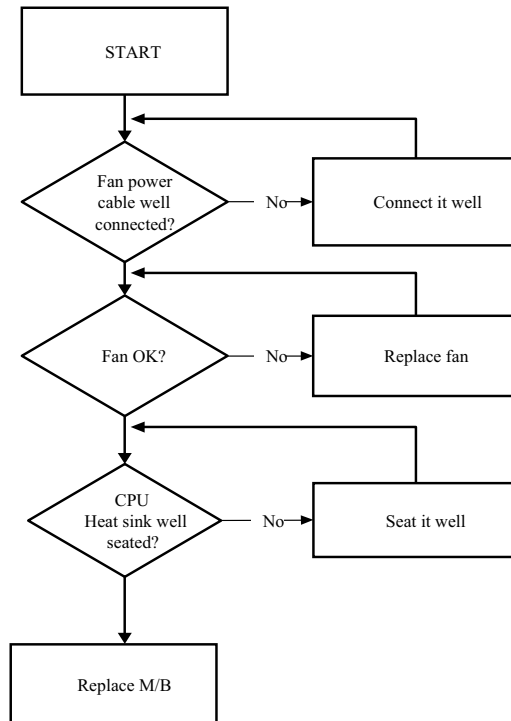

External Mouse Failure

If an external **Mouse** fails, perform the following actions one at a time to correct the problem.

1. Try an alternative mouse.
2. If the mouse uses a wireless connection, insert new batteries and confirm there is a good connection. See the mouse user manual.
3. If the mouse uses a USB connection, try an alternate USB port.
4. Try an alternative program to verify mouse operation. Reinstall the program experiencing mouse failure.
5. Restart the computer.
6. Remove any recently added hardware and associated software.
7. Remove any recently added software and reboot.
8. Restore system and file settings from a known good date using **System Restore**.
If the issue is not fixed, repeat the preceding steps and select an earlier time and date.
9. Run the Event Viewer to check the events log for errors. For more information see Windows Help and Support.
10. Roll back the mouse driver to the previous version if updated recently.
11. Remove and reinstall the mouse driver.
12. Check the Device Manager to determine that:
 - The device is properly installed. There are no red Xs or yellow exclamation marks.
 - There are no device conflicts.
 - No hardware is listed under Other Devices.

-
13. If the Issue is still not resolved, see “Online Support Information” on page 167.

Other Failures

If the CRT Switch, Dock, LAN Port, external MIC or Speakers, PCI Express Card, 5-in-1 Card Reader or Volume Wheel fail, perform the following general steps to correct the problem. Do not replace a non-defective FRUs:

1. Check Drive whether is OK.
2. Check Test Fixture is ok.
3. Swap M/B to Try.

Intermittent Problems

Intermittent system hang problems can be caused by a variety of reasons that have nothing to do with a hardware defect, such as: cosmic radiation, electrostatic discharge, or software errors. FRU replacement should be considered only when a recurring problem exists.

When analyzing an intermittent problem, do the following:

1. Run the advanced diagnostic test for the system board in loop mode at least 10 times.
2. If no error is detected, do not replace any FRU.
3. If any error is detected, replace the FRU. Rerun the test to verify that there are no more errors.

Undetermined Problems

The diagnostic problems does not identify which adapter or device failed, which installed devices are incorrect, whether a short circuit is suspected, or whether the system is inoperative.

Follow these procedures to isolate the failing FRU (do not isolate non-defective FRU).

NOTE: Verify that all attached devices are supported by the computer.

NOTE: Verify that the power supply being used at the time of the failure is operating correctly. (See “Power On Issue” on page 122.):

1. Power-off the computer.
2. Visually check them for damage. If any problems are found, replace the FRU.
3. Remove or disconnect all of the following devices:
 - Non-Acer devices
 - Printer, mouse, and other external devices
 - Battery pack
 - Hard disk drive
 - DIMM
 - CD-ROM/Diskette drive Module
 - PC Cards
4. Power-on the computer.
5. Determine if the problem has changed.
6. If the problem does not recur, reconnect the removed devices one at a time until you find the failing FRU.
7. If the problem remains, replace the following FRU one at a time. Do not replace a non-defective FRU:
 - System board
 - LCD assembly

Post Codes

These tables describe the POST codes and descriptions during the POST.

Sec:

NO_EVICTION_MODE_DEBUG EQU 1 (CommonPlatform\sec\la32\SecCore.inc)

Code	Description
0xC2	MTRR setup
0xC3	Enable cache
0xC4	Establish cache tags
0xC5	Enter NEM, Place the BSP in No Fill mode, set CR0.CD = 1, CR0.NW = 0.
0xCF	Cache Init Finished

Memory:

DEBUG_BIOS EQU 1 (Chipset\Alviso\MemoryInitAsm\IA32\IMEMORY.INC)

Code	Description
0xA0	First memory check point
0x01	Enable MCHBAR
0x02	Check for DRAM initialization interrupt and reset fail
0x03	Verify all DIMMs are DDR or DDR2 and unbuffered
0x04	Detect an improper warm reset and handle
0x05	Detect if ECC SO-DIMMs are present in the system
0x06	Verify all DIMMs are single or double sided and not asymmetric
0x07	Verify all DIMMs are x8 or x16 width
0x08	Find a common CAS latency between the DIMMS and the MCH
0x09	Determine the memory frequency and CAS latency to program
0x10	Determine the smallest common TRAS for all DIMMs
0x11	Determine the smallest common TRP for all DIMMs
0x12	Determine the smallest common TRCD for all DIMMs
0x13	Determine the smallest refresh period for all DIMMs
0x14	Verify burst length of 8 is supported by all DIMMs
0x15	Determine the smallest tWR supported by all DIMMs
0x16	Determine DIMM size parameters
0x17	Program the correct system memory frequency
0x18	Determine and set the mode of operation for the memory channels
0x19	Program clock crossing registers
0x20	Disable Fast Dispatch
0x21	Program the DRAM Row Attributes and DRAM Row Boundary registers
0x22	Program the DRAM Bank Architecture register
0x23	Program the DRAM Timing & and DRAM Control registers
0x24	Program ODT
0x25	Perform steps required before memory init
0x26	Program the receive enable reference timing control register Program the DLL Timing Control Registers, RCOMP settings
0x27	Enable DRAM Channel I/O Buffers

Code	Description
0x28	Enable all clocks on populated rows
0x29	Perform JEDEC memory initialization for all memory rows
0x30	Perform steps required after memory init
0x31	Program DRAM throttling and throttling event registers
0x32	Setup DRAM control register for normal operation and enable
0x33	Enable RCOMP
0x34	Clear DRAM initialization bit in the SB
0x35	Initialization Sequence Completed, program graphic clocks
0xAF	Disable access to the XMM registers

BDS & Specific action:

Code	Description
0x00	Report the legacy boot is happening
0x12	Wake up the APs
0x13	Initialize SMM Private Data and relocate BSP SMBASE
0x21	PC init begin at the stage1
0x27	Report every memory range do the hard ware ECC init
0x28	Report status code of every memory range
0x50	Get the root bridge handle
0x51	Notify pci bus driver starts to program the resource
0x58	Reset the host controller
0x5A	IdeBus begin initialization
0x70	Simple Text Output Protocol Functions (VGA class reset)
0x71	Report that VGA Class driver is being disabled
0x72	Report that VGA Class driver is being enabled
0x78	Terminal Console In reset and Console Out reset
0x79	Report that the remote terminal is being disabled
0x7A	Report that the remote terminal is being enabled
0x90	Keyboard reset
0x91	USB Keyboard disable
0x92	Keyboard detection
0x93	Report that the usb keyboard is being enabled
0x94	Clear the keyboard buffer
0x95	Init Keyboard
0x98	Mouse reset
0x99	Mouse disable
0x9A	Detect PS2 mouse
0x9B	Report that the mouse is being enabled
0xB8	Peripheral removable media reset(ex:IsaFloppy, USB device)
0xB9	Peripheral removable media disable
0xBB	Peripheral removable media enable
0xE4	Report Status Code here for DXE_ENTRY_POINT once it is available
0xF8	Report that ExitBootServices() has been called

Code	Description
0xF9	Runtime driver set virtual address map

Each PEIM entry point used in 80_PORT

Code	Description
0x00	
0x01	PEI_EVENT_LOG
0x02	PEI_OEM_SERVICE
0x03	PEI_SIO_INIT
0x04	PEI_MONO_STATUS_CODE
0x05	PEI_CPU_IO_PCI_CFG
0x06	PEI_CPU_IO
0x07	PEI_PCI_CFG
0x08	PEI_CPU_PEIM
0x09	PEI_PLATFORM_STAGE1
0x0A	PEI_VARIABLE
0x0B	PEI_SB_INIT
0x0C	PEI_CAPSULE
0x0D	PEI_PLATFORM_STAGE2
0x0E	PEI_SB_SMBUS_ARP_DISABLED
0x0F	PEI_HOST_TO_SYSTEM
0x10	PEI_MEMORY_INIT
0x11	PEI_S3_RESUME
0x12	PEI_CLOCK_GEN
0x13	PEI_OP_PRESENCE
0x14	PEI_TPM_TCG
0x15	PEI_FIND_FV
0x16	PEI_H2O_DEBUG_IO
0x17	PEI_H2O_DEBUG_COMM
0x18	PEI_SMM_CONTROL
0x19~0x1F	PEI_RESERVED
0x20~0x2E	PEI_OEM_DEFINED
0x2F	PEI_DXE_IPL

Each Driver entry point used in 80_PORT

Code	Description
0x30	RESERVED
0x31	DXE_CRC32_SECTION_EXTRACT
0x32	SCRIPT_SAVE
0x33	ACPI_S3_SAVE
0x34	SMART_TIMER
0x35	JPEG_DECODER
0x36	PCX_DECODER

Code	Description
0x37	HT_CPU / MP_CPU
0x38	LEGACY_METRONOME
0x39	FTWLITE
0x3A	RUN_RIME
0x3B	MONOTONIC_COUNTER
0x3C	WATCH_DOG_TIMER
0x3D	SECURITY_STUB
0x3E	DXE_CPU_IO
0x3F	CF9_RESET
0x40	PC_RTC
0x41	STATUS_CODE
0x42	VARIABLE
0x43	EMU_VARIABLE
0x44	DXE_CHIPSET_INIT
0x45	DXE_ALERT_FORMAT
0x46	PCI_HOST_BRIDGE
0x47	PCI_EXPRESS
0x48	DXE_SB_INIT
0x49	IDE_CONTROLLER
0x4A	SATA_CONTROLLER
0x4B	SB_SM_BUS
0x4C	ISA_ACPI_DRIVER
0x4D	ISA_BUS
0x4E	ISA_SERIAL
0x4F	IDE_BUS
0x50	PCI_BUS
0x51	BOOT_PRIORITY
0x52	FVB_SERVICE
0x53	ACPI_PLATFORM
0x54	PCI_HOT_PLUG
0x55	DXE_PLATFORM
0x56	PLATFORM_IDE
0x57	SMBIOS
0x58	MEMORY_SUB_CLASS
0x59	MISC_SUB_CLASS
0x5A	CON_PLATFORM
0x5B	SAVE_MEMORY_CONFIG
0x5C	ACPI_SUPPORT
0x5D	CON_SPLITTER_UGA_VGA / CON_SPLITTER
0x5E	VGA_CLASS
0x5F	DATA_HUB
0x60	DISK_IO
0x61	MEMORY_TEST

Code	Description
0x62	CRISIS_RECOVERY
0x63	LEGACY_8259
0x64	LEGACY_REGION
0x65	LEGACY_INTERRUPT
0x66	BIOS_KEYBOARD
0x67	BIOS_VEDIO
0x68	MONITER_KEY
0x69	LEGACY_BIOS
0x6A	LEGACY_BIOS_PLATFORM
0x6B	PCI_PLATFORM
0x6C	ISA_FLOOPY
0x6D	PS2_MOUSE
0x6E	USB_BOT
0x6F	USB_CBI0
0x70	USB_CBI1
0x71	USB_KB
0x72	USB_MASS_STORAGE
0x73	BUS_PCI_UHCI
0x74	USB_MOUSE
0x75	USB_BUS
0x76	SETUP_UTILITY
0x77	FW_BLOCK_SERVICE
0x78	USB_LEGACY_PLATFORM
0x79	GRAPHICS_CONSOLE
0x7A	TERMINAL
0x7B	DATA_HUB_STD_ERR
0x7C	FAT
0x7D	PARTITION
0x7E	ENGLISH
0x7F	FRENCH
0x80	HII_DATABASE
0x81	SETUP_BROWSER
0x82	OEM_SETUP_BROWSER
0x83	OEM_BADGING_SUPPORT
0x84	LEGACY_MOUSE
0x85	BIOS_SNP16
0x86	BUS_PCI_UNDI
0x87	SETUP_MOUSE
0x88	OEM_SETTING
0x89	MONITOR_KEY
0x8A	PLATFORM_BDS
0x8B	FAULT_TOLERANT_WRITE
0x8C	UPDATE_DISPATCHER

Code	Description
0x8D	CHINESE
0x8E	TPM_S3_Resume
0x8F	USB_EHCI
0x90	SNP_32_64
0x91	PXE_BC
0x92	PXE_DHCP4
0x93	EBC
0x94~0x9F	RESERVED
0xA0	DXE_H2O_DEBUG_IO
0xA1	DXE_H2O_DEBUG_IO
0xA2	DXE_TPM_TCG
0xA3	DXE_TPM_PHYSICAL_PRESENCE
0xA4	DXE_OEM_SERVICE
0xA5	DXE_EVENT_LOG
0xA6	DXE_SECURITY_HDD_PASSWORD_SERVICE
0xA7	DXE_LAN_ASF_INIT
0xA8	DXE_BUS_PCI_SERIAL
0xA9	DXE_LAN_IDER_CONTROLLER
0xAA	DXE_LAN_AMT
0xAB	DXE_SECURITY_SYSTEM_PASSWORD_SERVICE
0xAC	DXE_SECURITY_PASSWORD_CONSOLE
0xAD	DXE_DATA_HUB_RECORD_POLICY
0xAE	DXE_TPM_DRIVER
0xAF	RESERVED
0xB0	JAPANESE
0xB1	DXE_UNICODE_COLLATION

Each SmmDriver entry point used in 80_PORT

Code	Description
0xC0	SMM_ACCESS
0xC1	SMM_CONTROL
0xC2	SMM_BASE
0xC3	SMMAP
0xC4	SMMCORE
0xC5	SMM_DISPATCH
0xC6	SMM_START
0xC7	SMM_RUNTIME
0xC8	SB_SMM_DISPATCH
0xC9	SMM_THUNK
0xCA	SMM_ACPI_SW_CHILD
0xCB	SMM_SB_S3_SAVE
0xCC	SMM_PLATFORM
0xCD	SMM_GMCH_MBI

Code	Description
0xCE	SMM_FW_BLOCK_SERVICE
0xCF	SMM_VARIABLE
0xD0	SMM_IHISI
0xD1	SMM_INT15_MICROCODE
0xD2	SMM_PNP
0xD3	SMM_USB_LEGACY
0xD4	SMM_INT13_HDD
0xD5	SMM_INIT_PPM
0xD6	SMM_OHCI1394
0xD7	SMM_SECURITY_HDD_PASSWORD_SERVICE
0xD8	SMM_OEM_SERVICE
0xD9	SMM_PPM
0xDA	SMM_DIGITAL_THERMAL_SENSOR

Jumper and Connector Locations

Mainboard Description

Top View

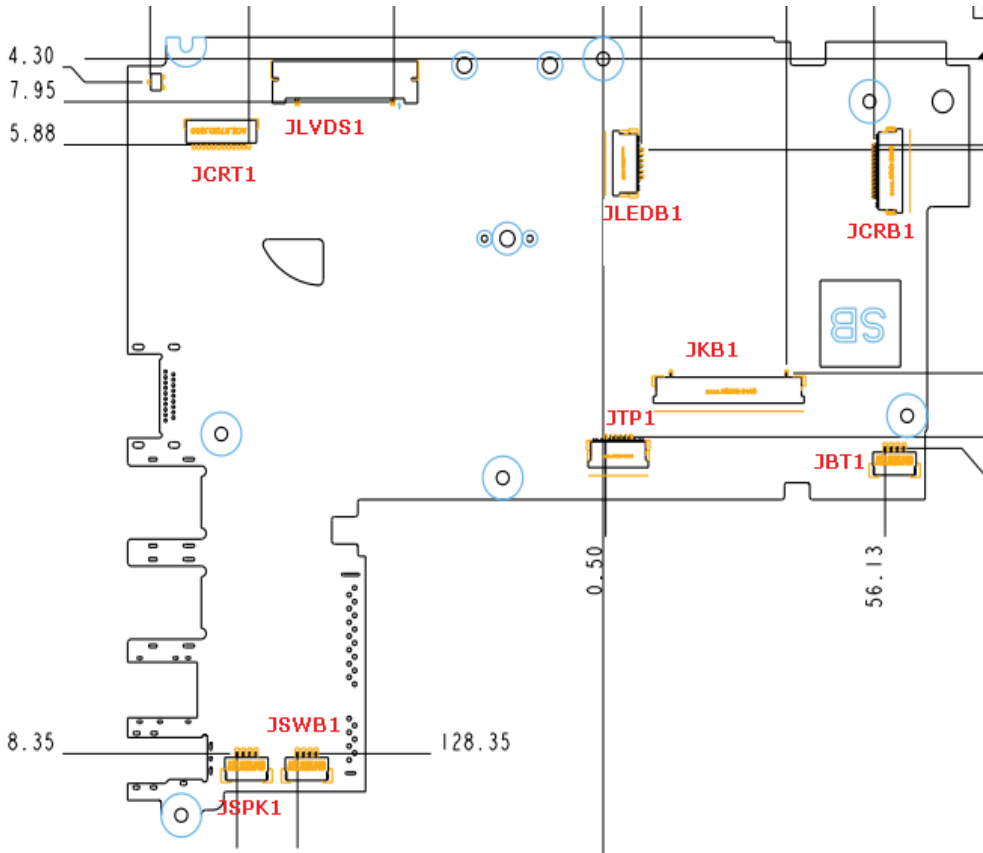

ITEM	DESCRIPTION
JCRT1	CRT Cable connector
JLVDS1	LCD connector
JLEDB1	LED Board connector
JCRB1	Card Reader board connector
JKB1	Internal keyboard connector
JTP1	T/P connector
JBT1	BT connector
JSPK1	Speaker connector
JSWB1	Switch board connector

Bottom View

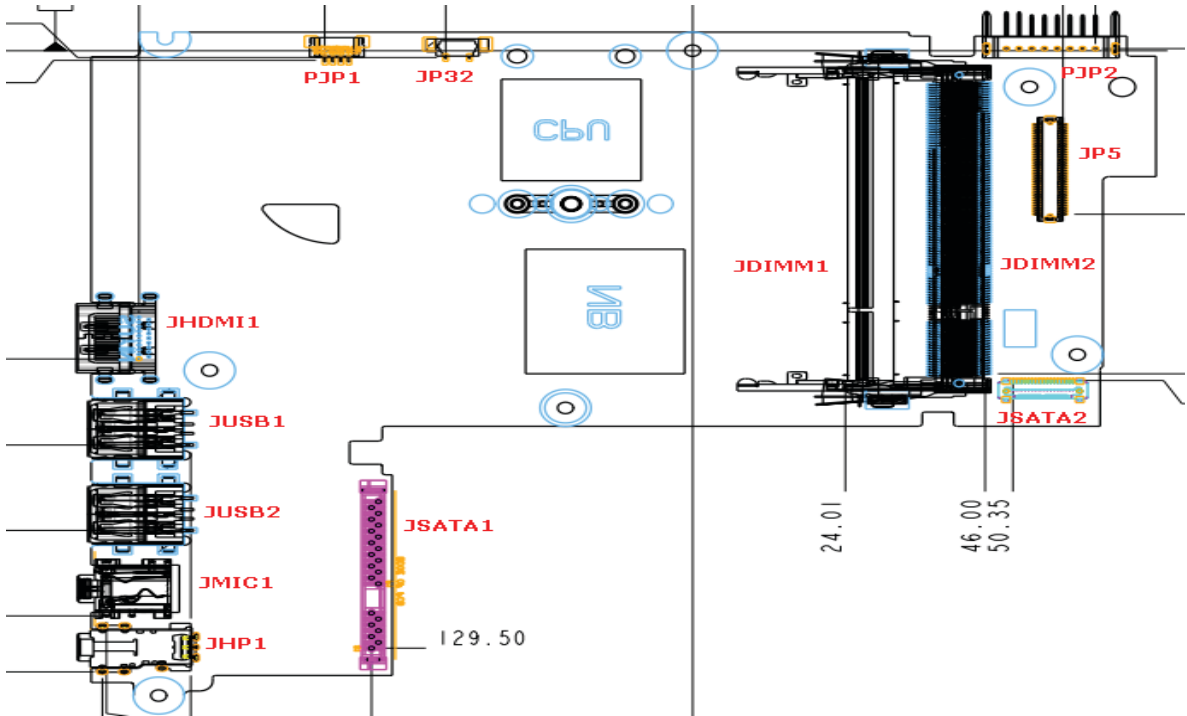

ITEM	DESCRIPTION
PJP1	DCIN Cable connector
JP32	FAN connector
PJP2	Battery connector
JHDMI1	HDMI connector
JUSB1	USB connector
JUSB2	USB connector
JMIC1	MIC Jack
JHP1	HP/SPDIF Jack
JSATA1	HDD connector
JDIMM1	RAM connector
JDIMM2	RAM connector
JP5	MB to I/O B connector
JSATA2	ODD connector

Clearing Password Check and BIOS Recovery

This section provides you with the standard operating procedures of clearing password and BIOS recovery for the computer. There is one Hardware Open Gap on the mainboard for clearing password check, and one Hotkey for enabling BIOS Recovery.

Clearing Password Check

Hardware Open Gap Description is as follows:

Item	Description
CLRP2	Clear CMOS Jumper

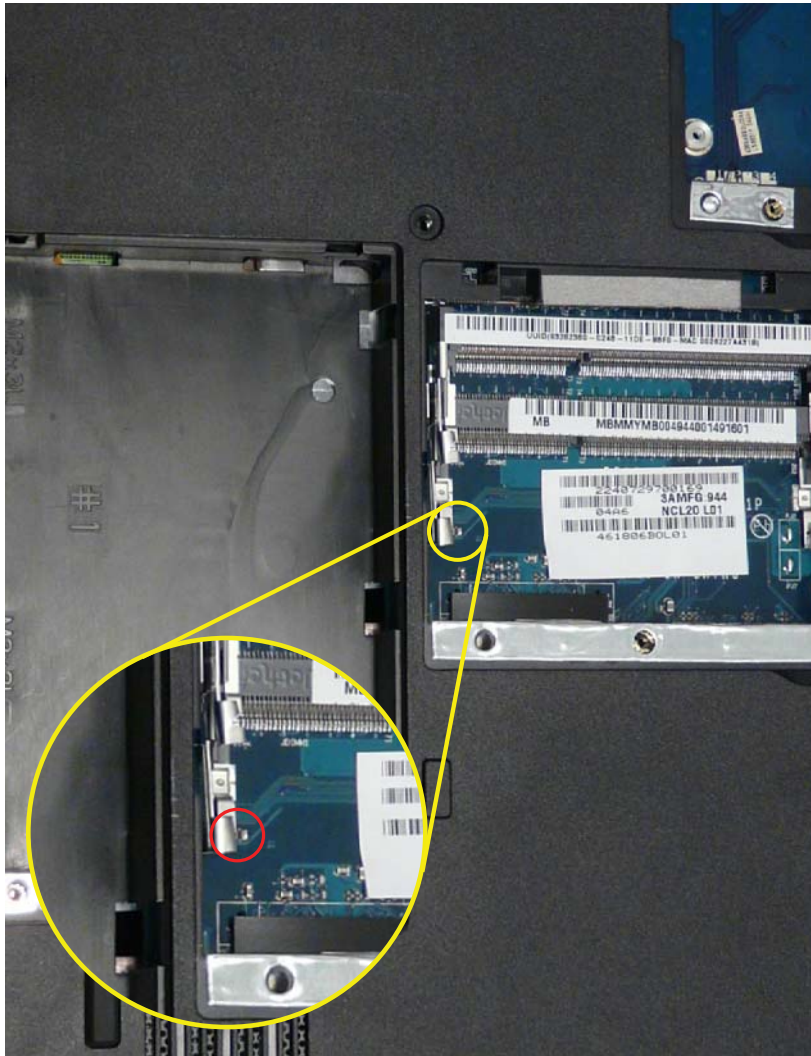

The CLRP2 jumper is located on the mainboard close to the DIMM module.

Steps for Clearing BIOS Password Check

If users set a BIOS Password (Supervisor Password and/or User Password) for security reasons, BIOS will ask for the password during system POST or when the system enters the BIOS Setup menu. If it is necessary to bypass the password check, users need to short the HW Gap to clear the password by using the following steps:

1. Power Off the system. Remove the AC, Battery and HDD from the machine.

-
2. Disconnect the RTC Battery cable and locate the CLRP2 jumper in the DIMM bay.
 3. Use an electric conductivity tool to short the two HW Gap points.
 4. Plug in AC, keep the HW Gap shorted, and press the Power Button to power on the system until BIOS POST finishes, then remove the tool from the HW Gap.
 5. Restart the system. Press the **F2** key to enter the BIOS Setup menu.
 6. If there is no Password request, the BIOS Password has cleared. Otherwise, please follow the steps above and try again.

NOTE: These steps are only for clearing the BIOS Password (Supervisor Password and User Password).

BIOS Recovery by Crisis Disk

BIOS Recovery Boot Block:

BIOS Recovery Boot Block is a special block of BIOS. It is used to boot up the system with minimum BIOS initialization. Users can enable this feature to restore the BIOS firmware to a successful one once the previous BIOS flashing process failed.

BIOS Recovery Hotkey:

The system provides a function hotkey: **Fn+Esc**, for enable BIOS Recovery process when system is powered on during BIOS POST. To use this function, it is strongly recommended to have the AC adapter and Battery present. If this function is enabled, the system will force the BIOS to enter a special BIOS block, called Boot Block.

Steps for BIOS Recovery from USB Storage:

Before doing this, prepare the Crisis USB key. The Crisis USB key could be made by executing the Crisis Disk program in another system with Windows XP OS.

Follow the steps below:

1. Save ROM file (file name: **JAL90x64.fd**) to the root directory of USB storage.
2. Plug USB storage into USB port.
3. Press **Fn + ESC** button then plug in AC.

The Power button flashes once.

4. Press **Power** button to initiate system CRISIS mode.

When CRISIS is complete, the system auto restarts with a workable BIOS.

5. Update the latest version BIOS for this machine by regular BIOS flashing process.

Steps for BIOS Recovery by Crisis Disk:

Before doing this, a Crisis Diskette should be prepared ready in hand. The Crisis Diskette could be made by executing the Crisis Disk program in another system with Windows XP OS.

Follow the steps below:

1. Power Off failed system.
2. Attach a USB floppy drive to the failed system.
3. Copy **xxxx.wph** to tool's folder and rename it as **BIOS.wph**.
4. Execute **wincris.exe** to start the Crisis Disk Build.
5. Select **Removable** and click **Start**.
6. Select **Quick Format Disk** and click **Start**. A progress screen displays.
7. Click **OK** to complete the process.
8. Insert the Crisis Disk in to the USB floppy drive attached to the BIOS flash failed system.
9. In the power-off state, press and hold **Fn+Esc** then press the Power button.

The system powers on and the Crisis BIOS Recovery process begins.

BIOS Boot Block begins restoring the BIOS code from the Crisis floppy disk to BIOS ROM on the failed systems.

When the Crisis flash process is finished, the system restarts with a workable BIOS.

Update to the latest version BIOS for the system using the regular BIOS flashing process.

FRU (Field Replaceable Unit) List

This chapter gives you the FRU (Field Replaceable Unit) listing in global configurations of the computer. Refer to this chapter whenever ordering for parts to repair or for RMA (Return Merchandise Authorization).

Please note that WHEN ORDERING FRU PARTS, you should check the most up-to-date information available on your regional web or channel. For whatever reasons a part number change is made, it will not be noted on the printed Service Guide. For ACER AUTHORIZED SERVICE PROVIDERS, your Acer office may have a DIFFERENT part number code from those given in the FRU list of this printed Service Guide. You MUST use the local FRU list provided by your regional Acer office to order FRU parts for repair and service of customer machines.

NOTE: To scrap or to return the defective parts, you should follow the local government ordinance or regulations on how to dispose it properly, or follow the rules set by your regional Acer office on how to return it.

Exploded Diagrams

Main Assembly

LCD Assembly

FRU List

Category	Description	Acer PN
Adapter		
	Adapter DELTA 30W 19V 1.7x5.5x11 Black ADP-30JH BA LF	AP.03001.001
	Adapter LITE-ON 30W 19V 1.7x5.5x11 Black PA-1300-04AC LF	AP.03003.001
	Adapter HIPRO 30W 19V 1.7x5.5x11 Black HP-A0301R3 B1LF LF	AP.0300A.001
Battery		
	Battery SIMPLO UM-2009E Li-Ion 3S2P PANASONIC 6 cell 4400mAh Main COMMON ID:UM09E71	BT.00607.106
	Battery SIMPLO UM-2009E Li-Ion 3S2P SAMSUNG 6 cell 4400mAh Main COMMON ID:UM09E75	BT.00607.107
	Battery SANYO UM-2009E Li-Ion 3S2P SANYO 6 cell 4400mAh Main COMMON ID: UM09E31	BT.00603.098
	Battery PANASONIC UM-2009E Li-Ion 3S2P PANASONIC 6 cell 4400mAh Main COMMON ID:UM09E51	BT.00605.052
	Battery SANYO UM-2009E Li-Ion 3S2P SANYO 6 cell 5600mAh Main COMMON ID:UM09E36	BT.00603.096
	Battery SIMPLO UM-2009E Li-Ion 3S2P SAMSUNG 6 cell 5600mAh Main COMMON ID:UM09E70	BT.00607.102
	Battery PANASONIC UM-2009E Li-Ion 3S2P PANASONIC 6 cell 5800mAh Main COMMON ID:UM09E56	BT.00605.050
Board		
	FOXCONN BLUETOOTH BRM 2046 BT2.1 (T60H928.33) F/W:861	BH.21100.004
	IO BOARD FOR W/O 3G FUNCTION	55.WHA02.001
	IO BOARD FOR W/3G FUNCTION	55.WJ302.001
	SWITCH BOARD	55.WHA02.002
	TOUCH PAD BUTTON BOARD	55.WHA02.003
	CARD READER BOARD	55.WHA02.004
	ODD BOARD	55.WHA02.005
	LED BOARD	55.WHA02.006
	FOXCONN WIRELESS LAN Atheros HB95 1X1 BG (HM)	NI.23600.047
	Lan Intel WLAN 512AN_HMWG Shirley Peak 5100 MM#895373	KI.SPH01.003
	Lan Intel WLAN 512AG_HMWG Shirley Peak 5100 MM#897072	KI.SPH01.005
	Lan Intel WLAN 112BN.HMWG MM#903341	KI.CPH01.001
	QUALCOMM GOBI2000	LC.21300.011
Cable		
	BLUE TOOTH CABLE	50.WHA02.001
	SWITCH BOARD CABLE	50.WHA02.002
	D-SUB CABLE	50.WHA02.003
	ODD CABLE INCL. ODD RUBBER	50.WHA02.004
	POWER CORD US 3 PIN	27.TAVV5.001
	POWER CORD EU 3 PIN	27.TAVV5.002

Category	Description	Acer PN
	POWER CORD AUS 3 PIN	27.TAVV5.003
	POWER CORD UK 3 PIN	27.TAVV5.004
	POWER CORD CHINA 3 PIN	27.TAVV5.005
	POWER CORD SWISS 3 PIN	27.TAVV5.006
	POWER CORD ITALIAN 3 PIN	27.TAVV5.007
	POWER CORD DENMARK 3 PIN	27.TAVV5.008
	POWER CORD JP 3 PIN	27.TAVV5.009
	POWER CORD SOUTH AFRICA 3 PIN	27.TAVV5.010
	POWER CORD KOREA 3 PIN	27.TAVV5.011
	POWER CORD ISRAEL 3 PIN	27.TAVV5.012
	POWER CORD INDIA 3 PIN	27.TAVV5.013
	POWER CORD TWN 3 PIN	27.TAVV5.014
	POWER CORD ARGENTINA 3 PIN	27.APV02.001
Case/Cover/Bracket Assembly		
	UPPER CASE ASSY W/ TP, TP RUBBER - BLACK	60.WHA02.001
	UPPER CASE ASSY W/ TP, TP RUBBER - RED	60.WHC02.001
	LOWER CASE FOR W/O 3G FUNCTION	60.WHA02.002
	LOWER CASE FOR W/ 3G FUNCTION	60.WJ302.001
	WLAN DOOR	42.WHA02.001
	RAM DOOR	42.WHA02.002
	HDD DOOR	42.WHA02.003
	HDD HOUSING	33.WHA02.001
	HDD ADAPTER	20.WHA02.001
HDD/Hard Disk Drive		
	HDD SEAGATE 2.5" 5400rpm 160GB ST9160314AS Wyatt SATA LF F/W:0001SDM1	KH.16001.042
	HDD TOSHIBA 2.5" 5400rpm 160GB MK1655GSX Libra SATA LF F/W: FG011J	KH.16004.006
	HDD TOSHIBA 2.5" 5400rpm 250GB MK2555GSX Libra SATA LF F/W:FG001J	KH.25004.003
	HDD HGST 2.5" 5400rpm 250GB HTS545025B9A300 Panther B SATA LF F/W:C60F Disk imbalance criteria = 0.014g-cm	KH.25007.016
	HDD WD 2.5" 5400rpm 250GB WD2500BEVT-22ZCT0 ML160 SATA LF F/W:11.01A11	KH.25008.021
	HDD SEAGATE 2.5" 5400rpm 320GB ST9320325AS Wyatt SATA LF F/W:0001SDM1	KH.32001.017
	HDD TOSHIBA 2.5" 5400rpm 320GB MK3263GSX SATA 8MB 68P LF F/W:FG020J	KH.32004.003
	HDD HGST 2.5" 5400rpm 320GB HTS545032B9A300 Panther B SATA LF F/W:C60F Disk imbalance criteria = 0.014g-cm	KH.32007.008
	HDD SEAGATE 2.5" 5400rpm 400GB ST9400326AS, Wyatt, 250G/P SATA 8MB LF F/W:0001SDM1	KH.40001.011
	HDD TOSHIBA 2.5" 5400rpm 500GB MK5055GSX Libra SATA LF F/W:FG001J	KH.50004.001
	HDD HGST 2.5" 5400rpm 500GB HTS545050B9A300 Panther B SATA LF F/W:C60F Disk imbalance criteria = 0.014g-cm	KH.50007.010

Category	Description	Acer PN
	HDD WD 2.5" 5400rpm 500GB WD5000BEVT-22ZAT0 ML250 SATA LF F/W:01.01A01	KH.50008.013
Keyboard		
	Keyboard GATEWAY GP-1T SJM11 Internal 11 Standard 86KS Black US International Texture	KB.I110G.026
	Keyboard GATEWAY GP-1T SJM11 Internal 11 Standard 86KS Black Greek Texture	KB.I110G.011
	Keyboard GATEWAY GP-1T SJM11 Internal 11 Standard 86KS Black Arabic Texture	KB.I110G.002
	Keyboard GATEWAY GP-1T SJM11 Internal 11 Standard 86KS Black Chinese Texture	KB.I110G.006
	Keyboard GATEWAY GP-1T SJM11 Internal 11 Standard 86KS Black Russian Texture	KB.I110G.018
	Keyboard GATEWAY GP-1T SJM11 Internal 11 Standard 86KS Black US International w/ Hebrew Texture	KB.I110G.027
	Keyboard GATEWAY GP-1T SJM11 Internal 11 Standard 86KS Black Thailand Texture	KB.I110G.023
	Keyboard GATEWAY GP-1T SJM11 Internal 11 Standard 87KS Black UK Texture	KB.I110G.025
	Keyboard GATEWAY GP-1T SJM11 Internal 11 Standard 87KS Black German Texture	KB.I110G.010
	Keyboard GATEWAY GP-1T SJM11 Internal 11 Standard 87KS Black Swiss/G Texture	KB.I110G.022
	Keyboard GATEWAY GP-1T SJM11 Internal 11 Standard 87KS Black Belgium Texture	KB.I110G.003
	Keyboard GATEWAY GP-1T SJM11 Internal 11 Standard 87KS Black Danish Texture	KB.I110G.007
	Keyboard GATEWAY GP-1T SJM11 Internal 11 Standard 87KS Black Italian Texture	KB.I110G.013
	Keyboard GATEWAY GP-1T SJM11 Internal 11 Standard 87KS Black French Texture	KB.I110G.009
	Keyboard GATEWAY GP-1T SJM11 Internal 11 Standard 87KS Black Hungarian Texture	KB.I110G.012
	Keyboard GATEWAY GP-1T SJM11 Internal 11 Standard 87KS Black Norwegian Texture	KB.I110G.016
	Keyboard GATEWAY GP-1T SJM11 Internal 11 Standard 87KS Black Portuguese Texture	KB.I110G.017
	Keyboard GATEWAY GP-1T SJM11 Internal 11 Standard 87KS Black Spanish Texture	KB.I110G.020
	Keyboard GATEWAY GP-1T SJM11 Internal 11 Standard 87KS Black US w/ Canadian French Texture	KB.I110G.028
	Keyboard GATEWAY GP-1T SJM11 Internal 11 Standard 87KS Black Turkish Texture	KB.I110G.024
	Keyboard GATEWAY GP-1T SJM11 Internal 11 Standard 87KS Black Sweden Texture	KB.I110G.021
	Keyboard GATEWAY GP-1T SJM11 Internal 11 Standard 87KS Black FR/Arabic Texture	KB.I110G.008
	Keyboard GATEWAY GP-1T SJM11 Internal 11 Standard 87KS Black Nordic Texture	KB.I110G.015

Category	Description	Acer PN
	Keyboard GATEWAY GP-1T SJM11 Internal 11 Standard 87KS Black SLO/CRO Texture	KB.I110G.019
	Keyboard GATEWAY GP-1T SJM11 Internal 11 Standard 87KS Black CZ/SK Texture	KB.I110G.005
	Keyboard GATEWAY GP-1T SJM11 Internal 11 Standard 87KS Black Brazilian Portuguese Texture	KB.I110G.004
	Keyboard GATEWAY GP-1T SJM11 Internal 11 Standard 91KS Black Japanese Texture	KB.I110G.014
LCD		
	ASSY LED MODULE 11.6" WSVGA Glare W/ANTENNA, CCD, BLACK - GTW	6M.WHA02.001
	LED LCD AUO 11.6" WSVGA Glare B116AW02 V0 LF 200nit 16ms 500:1	LK.11605.004
	LED LCD LPL 11.6" WSVGA Glare LP116WSA-TLA1 LF 200nit 16ms	LK.11608.002
CASE/COVER/ BRACKET ASSEMBLY	LCD COVER IMR-BLACK GW	60.WHA02.003
CABLE	ANTENNA WLAN	50.WHA02.005
CABLE	LCD CABLE ASSY W/ MIC	50.WHA02.006
CASE/COVER/ BRACKET ASSEMBLY	LCD BEZEL-GW	60.WHA02.004
CASE/COVER/ BRACKET ASSEMBLY	LCD BRACKET R&L	33.WHA02.003
DIGITAL LIGHT DEVICE	CAMERA 0.3M	57.WHA02.001
	ASSY LED MODULE 11.6" WSVGA Glare W/ANTENNA, CCD, BLACK - PB	6M.BGH02.001
	LED LCD AUO 11.6" WSVGA Glare B116AW02 V0 LF 200nit 16ms 500:1	LK.11605.004
	LED LCD LPL 11.6" WSVGA Glare LP116WSA-TLA1 LF 200nit 16ms	LK.11608.002
CASE/COVER/ BRACKET ASSEMBLY	LCD COVER IMR-BLACK PB	60.BGH02.001
CABLE	ANTENNA WLAN	50.WHA02.005
CABLE	LCD CABLE ASSY W/ MIC	50.WHA02.006
CASE/COVER/ BRACKET ASSEMBLY	LCD BEZEL-PB	60.BGH02.002
CASE/COVER/ BRACKET ASSEMBLY	LCD BRACKET R&L	33.WHA02.003
DIGITAL LIGHT DEVICE	CAMERA 0.3M	57.WHA02.001

Category	Description	Acer PN
	ASSY LED MODULE 11.6" WSVGA Glare W/ANTENNA, CCD, RED - GTW	6M.WHC02.001
	LED LCD AUO 11.6" WSVGA Glare B116AW02 V0 LF 200nit 16ms 500:1	LK.11605.004
	LED LCD LPL 11.6" WSVGA Glare LP116WSA-TLA1 LF 200nit 16ms	LK.11608.002
CASE/COVER/ BRACKET ASSEMBLY	LCD COVER IMR-RED GW	60.WHC02.002
CABLE	ANTENNA WLAN	50.WHA02.005
CABLE	LCD CABLE ASSY W/ MIC	50.WHA02.006
CASE/COVER/ BRACKET ASSEMBLY	LCD BEZEL-GW	60.WHA02.004
CASE/COVER/ BRACKET ASSEMBLY	LCD BRACKET R&L	33.WHA02.003
DIGITAL LIGHT DEVICE	CAMERA 0.3M	57.WHA02.001
	ASSY LED MODULE 11.6" WSVGA Glare W/ANTENNA, CCD, RED - PB	6M.BGK02.001
	LED LCD AUO 11.6" WSVGA Glare B116AW02 V0 LF 200nit 16ms 500:1	LK.11605.004
	LED LCD LPL 11.6" WSVGA Glare LP116WSA-TLA1 LF 200nit 16ms	LK.11608.002
CASE/COVER/ BRACKET ASSEMBLY	LCD COVER IMR-RED PB	60.BGK02.001
CABLE	ANTENNA WLAN	50.WHA02.005
CABLE	LCD CABLE ASSY W/ MIC	50.WHA02.006
CASE/COVER/ BRACKET ASSEMBLY	LCD BEZEL-PB	60.BGH02.002
CASE/COVER/ BRACKET ASSEMBLY	LCD BRACKET R&L	33.WHA02.003
DIGITAL LIGHT DEVICE	CAMERA 0.3M	57.WHA02.001
	ASSY LED MODULE 11.6" WXGA Glare W/ANTENNA, CCD, BLACK - GTW	6M.WHA02.002
	LED LCD AUO 11.6" WXGA Glare B116XW02 V0 1A (3G) LF 200nit 8ms 500:1	LK.11605.003
	LED LCD LPL 11.6" WXGA Glare LP116WH1-TLA1 LF 200nit 8ms 500:1	LK.11608.001
CASE/COVER/ BRACKET ASSEMBLY	LCD COVER IMR-BLACK GW	60.WHA02.003
CABLE	ANTENNA WLAN	50.WHA02.005
CABLE	LCD CABLE ASSY W/ MIC	50.WHA02.006

Category	Description	Acer PN
CASE/COVER/ BRACKET ASSEMBLY	LCD BEZEL-GW	60.WHA02.004
CASE/COVER/ BRACKET ASSEMBLY	LCD BRACKET R&L	33.WHA02.003
DIGITAL LIGHT DEVICE	CAMERA 0.3M	57.WHA02.001
	ASSY LED MODULE 11.6" WXGA Glare W/ANTENNA, CCD, BLACK - PB	6M.BGH02.002
	LED LCD AUO 11.6" WXGA Glare B116XW02 V0 1A (3G) LF 200nit 8ms 500:1	LK.11605.003
	LED LCD LPL 11.6" WXGA Glare LP116WH1-TLA1 LF 200nit 8ms 500:1	LK.11608.001
CASE/COVER/ BRACKET ASSEMBLY	LCD COVER IMR-BLACK PB	60.BGH02.001
CABLE	ANTENNA WLAN	50.WHA02.005
CABLE	LCD CABLE ASSY W/ MIC	50.WHA02.006
CASE/COVER/ BRACKET ASSEMBLY	LCD BEZEL-PB	60.BGH02.002
CASE/COVER/ BRACKET ASSEMBLY	LCD BRACKET R&L	33.WHA02.003
DIGITAL LIGHT DEVICE	CAMERA 0.3M	57.WHA02.001
	ASSY LED MODULE 11.6" WXGA Glare W/ANTENNA, CCD, RED - GTW	6M.WHC02.002
	LED LCD AUO 11.6" WXGA Glare B116XW02 V0 1A (3G) LF 200nit 8ms 500:1	LK.11605.003
	LED LCD LPL 11.6" WXGA Glare LP116WH1-TLA1 LF 200nit 8ms 500:1	LK.11608.001
CASE/COVER/ BRACKET ASSEMBLY	LCD COVER IMR-RED GW	60.WHC02.002
CABLE	ANTENNA WLAN	50.WHA02.005
CABLE	LCD CABLE ASSY W/ MIC	50.WHA02.006
CASE/COVER/ BRACKET ASSEMBLY	LCD BEZEL-GW	60.WHA02.004
CASE/COVER/ BRACKET ASSEMBLY	LCD BRACKET R&L	33.WHA02.003
DIGITAL LIGHT DEVICE	CAMERA 0.3M	57.WHA02.001

Category	Description	Acer PN
	ASSY LED MODULE 11.6" WXGA Glare W/ANTENNA, CCD, RED - PB	6M.BGK02.002
	LED LCD AUO 11.6" WXGA Glare B116XW02 V0 1A (3G) LF 200nit 8ms 500:1	LK.11605.003
	LED LCD LPL 11.6" WXGA Glare LP116WH1-TLA1 LF 200nit 8ms 500:1	LK.11608.001
CASE/COVER/ BRACKET ASSEMBLY	LCD COVER IMR-RED PB	60.BGK02.001
CABLE	ANTENNA WLAN	50.WHA02.005
CABLE	LCD CABLE ASSY W/ MIC	50.WHA02.006
CASE/COVER/ BRACKET ASSEMBLY	LCD BEZEL-PB	60.BGH02.002
CASE/COVER/ BRACKET ASSEMBLY	LCD BRACKET R&L	33.WHA02.003
DIGITAL LIGHT DEVICE	CAMERA 0.3M	57.WHA02.001
	ASSY LED MODULE 11.6" WSVGA Glare W/ANTENNA, CCD, 3G, BLACK - GTW	6M.WJ302.001
	LED LCD AUO 11.6" WSVGA Glare B116AW02 V0 LF 200nit 16ms 500:1	LK.11605.004
	LED LCD LPL 11.6" WSVGA Glare LP116WSA-TLA1 LF 200nit 16ms	LK.11608.002
CASE/COVER/ BRACKET ASSEMBLY	LCD COVER IMR-BLACK GW	60.WHA02.003
CABLE	ANTENNA WLAN	50.WHA02.005
CABLE	ANTENNA 3G	50.WJ302.001
CABLE	LCD CABLE ASSY W/ MIC	50.WHA02.006
CASE/COVER/ BRACKET ASSEMBLY	LCD BEZEL-GW	60.WHA02.004
CASE/COVER/ BRACKET ASSEMBLY	LCD BRACKET R&L	33.WHA02.003
DIGITAL LIGHT DEVICE	CAMERA 0.3M	57.WHA02.001
	ASSY LED MODULE 11.6" WSVGA Glare W/ANTENNA, CCD, 3G, BLACK - PB	6M.BGH02.003
	LED LCD AUO 11.6" WSVGA Glare B116AW02 V0 LF 200nit 16ms 500:1	LK.11605.004
	LED LCD LPL 11.6" WSVGA Glare LP116WSA-TLA1 LF 200nit 16ms	LK.11608.002
CASE/COVER/ BRACKET ASSEMBLY	LCD COVER IMR-BLACK PB	60.BGH02.001
CABLE	ANTENNA WLAN	50.WHA02.005
CABLE	ANTENNA 3G	50.WJ302.001

Category	Description	Acer PN
CABLE	LCD CABLE ASSY W/ MIC	50.WHA02.006
CASE/COVER/ BRACKET ASSEMBLY	LCD BEZEL-PB	60.BGH02.002
CASE/COVER/ BRACKET ASSEMBLY	LCD BRACKET R&L	33.WHA02.003
DIGITAL LIGHT DEVICE	CAMERA 0.3M	57.WHA02.001
	ASSY LED MODULE 11.6" WSVGA Glare W/ANTENNA, CCD, 3G, RED - GTW	6M.WJ202.001
	LED LCD AUO 11.6" WSVGA Glare B116AW02 V0 LF 200nit 16ms 500:1	LK.11605.004
	LED LCD LPL 11.6" WSVGA Glare LP116WSA-TLA1 LF 200nit 16ms	LK.11608.002
CASE/COVER/ BRACKET ASSEMBLY	LCD COVER IMR-RED GW	60.WHC02.002
CABLE	ANTENNA WLAN	50.WHA02.005
CABLE	ANTENNA 3G	50.WJ302.001
CABLE	LCD CABLE ASSY W/ MIC	50.WHA02.006
CASE/COVER/ BRACKET ASSEMBLY	LCD BEZEL-GW	60.WHA02.004
CASE/COVER/ BRACKET ASSEMBLY	LCD BRACKET R&L	33.WHA02.003
DIGITAL LIGHT DEVICE	CAMERA 0.3M	57.WHA02.001
	ASSY LED MODULE 11.6" WSVGA Glare W/ANTENNA, CCD, 3G, RED - PB	6M.BGK02.003
	LED LCD AUO 11.6" WSVGA Glare B116AW02 V0 LF 200nit 16ms 500:1	LK.11605.004
	LED LCD LPL 11.6" WSVGA Glare LP116WSA-TLA1 LF 200nit 16ms	LK.11608.002
CASE/COVER/ BRACKET ASSEMBLY	LCD COVER IMR-RED PB	60.BGK02.001
CABLE	ANTENNA WLAN	50.WHA02.005
CABLE	ANTENNA 3G	50.WJ302.001
CABLE	LCD CABLE ASSY W/ MIC	50.WHA02.006
CASE/COVER/ BRACKET ASSEMBLY	LCD BEZEL-PB	60.BGH02.002
CASE/COVER/ BRACKET ASSEMBLY	LCD BRACKET R&L	33.WHA02.003
DIGITAL LIGHT DEVICE	CAMERA 0.3M	57.WHA02.001

Category	Description	Acer PN
	ASSY LED MODULE 11.6" WXGA Glare W/ANTENNA, CCD, 3G, BLACK - GTW	6M.WJ302.002
	LED LCD AUO 11.6" WXGA Glare B116XW02 V0 1A (3G) LF 200nit 8ms 500:1	LK.11605.003
	LED LCD LPL 11.6" WXGA Glare LP116WH1-TLA1 LF 200nit 8ms 500:1	LK.11608.001
CASE/COVER/ BRACKET ASSEMBLY	LCD COVER IMR-BLACK GW	60.WHA02.003
CABLE	ANTENNA WLAN	50.WHA02.005
CABLE	ANTENNA 3G	50.WJ302.001
CABLE	LCD CABLE ASSY W/ MIC	50.WHA02.006
CASE/COVER/ BRACKET ASSEMBLY	LCD BEZEL-GW	60.WHA02.004
CASE/COVER/ BRACKET ASSEMBLY	LCD BRACKET R&L	33.WHA02.003
DIGITAL LIGHT DEVICE	CAMERA 0.3M	57.WHA02.001
	ASSY LED MODULE 11.6" WXGA Glare W/ANTENNA, CCD, 3G, BLACK - PB	6M.BGH02.004
	LED LCD AUO 11.6" WXGA Glare B116XW02 V0 1A (3G) LF 200nit 8ms 500:1	LK.11605.003
	LED LCD LPL 11.6" WXGA Glare LP116WH1-TLA1 LF 200nit 8ms 500:1	LK.11608.001
CASE/COVER/ BRACKET ASSEMBLY	LCD COVER IMR-BLACK PB	60.BGH02.001
CABLE	ANTENNA WLAN	50.WHA02.005
CABLE	ANTENNA 3G	50.WJ302.001
CABLE	LCD CABLE ASSY W/ MIC	50.WHA02.006
CASE/COVER/ BRACKET ASSEMBLY	LCD BEZEL-PB	60.BGH02.002
CASE/COVER/ BRACKET ASSEMBLY	LCD BRACKET R&L	33.WHA02.003
DIGITAL LIGHT DEVICE	CAMERA 0.3M	57.WHA02.001
	ASSY LED MODULE 11.6" WXGA Glare W/ANTENNA, CCD, 3G, RED - GTW	6M.WJ202.002
	LED LCD AUO 11.6" WXGA Glare B116XW02 V0 1A (3G) LF 200nit 8ms 500:1	LK.11605.003
	LED LCD LPL 11.6" WXGA Glare LP116WH1-TLA1 LF 200nit 8ms 500:1	LK.11608.001
CASE/COVER/ BRACKET ASSEMBLY	LCD COVER IMR-RED GW	60.WHC02.002
CABLE	ANTENNA WLAN	50.WHA02.005

Category	Description	Acer PN
CABLE	ANTENNA 3G	50.WJ302.001
CABLE	LCD CABLE ASSY W/ MIC	50.WHA02.006
CASE/COVER/ BRACKET ASSEMBLY	LCD BEZEL-GW	60.WHA02.004
CASE/COVER/ BRACKET ASSEMBLY	LCD BRACKET R&L	33.WHA02.003
DIGITAL LIGHT DEVICE	CAMERA 0.3M	57.WHA02.001
	ASSY LED MODULE 11.6" WXGA Glare W/ANTENNA, CCD, 3G, RED - PB	6M.BGK02.004
	LED LCD AUO 11.6" WXGA Glare B116XW02 V0 1A (3G) LF 200nit 8ms 500:1	LK.11605.003
	LED LCD LPL 11.6" WXGA Glare LP116WH1-TLA1 LF 200nit 8ms 500:1	LK.11608.001
CASE/COVER/ BRACKET ASSEMBLY	LCD COVER IMR-RED PB	60.BGK02.001
CABLE	ANTENNA WLAN	50.WHA02.005
CABLE	ANTENNA 3G	50.WJ302.001
CABLE	LCD CABLE ASSY W/ MIC	50.WHA02.006
CASE/COVER/ BRACKET ASSEMBLY	LCD BEZEL-PB	60.BGH02.002
CASE/COVER/ BRACKET ASSEMBLY	LCD BRACKET R&L	33.WHA02.003
DIGITAL LIGHT DEVICE	CAMERA 0.3M	57.WHA02.001
Memory		
	Memory MICRON SO-DIMM DDRIII 1066 1GB MT8JSF12864HZ-1G1F1 LF 128*8 0.065um	KN.1GB04.015
	Memory ELPIDA SO-DIMM DDRIII 1066 1GB EBJ10UE8BDS0-AE-F LF 128*8 0.065um	KN.1GB09.012
	Memory SAMSUNG SO-DIMM DDRIII 1066 1GB M471B2873EH1-CF8 LF 64*16 0.055um	KN.1GB0B.028
	Memory HYNIX SO-DIMM DDRIII 1066 1GB HMT112S6BFR6C-G7 N0 LF 64*16 0.055um	KN.1GB0G.025
	Memory ELPIDA SO-DIMM DDRIII 1066 2GB EBJ21UE8BDS0-AE-F LF 128*8 0.065um	KN.2GB09.006
	Memory SAMSUNG SO-DIMM DDRIII 1066 2GB M471B5673EH1-CF8 LF 128*8 0.055um	KN.2GB0B.012
	Memory HYNIX SO-DIMM DDRIII 1066 2GB HMT125S6BFR8C-G7 N0 LF 128*8 0.055um	KN.2GB0G.014
Mainboard		
MAINBOARD	MAINBOARD EC14D LF UMA_SJM13_MS_INTEL SU4100/ NON3G	MB.WHA02.00 3

Category	Description	Acer PN
	MAINBOARD EC14D LF UMA_SJM13_MS_INTEL CELERON 743/NON3G	MB.WHA02.005
	MAINBOARD EC14D LF UMA_SJM13_MS_INTEL SU2300/NON3G	MB.WHA02.010
	MAINBOARD EC14D LF UMA_SJM13_MS_INTEL SU7300/NON3G	MB.WHA02.002
Heatsink		
	THERMAL MODULE	60.WHA02.005
Speaker		
SPEAKER	SPEAKER R+L	23.WHA02.001
Miscellaneous		
	ODD MYLAR (STICKER)	47.WHA02.001
	SIGNAL PLATE FOR W/O BT FUNCTION	47.WHA02.002
	SIGNAL PLATE FOR W/ BT FUNCTION	47.WHA02.003

Screw List

Category	Description	Acer PN
SCREW	SCREW 1.98D 3.0L K 4.6D NI NL	86.WHA02.001
SCREW	SCREW 1.98D 4.0L K 4.6D 0.8T ZKNL	86.WHA02.002
SCREW	SCREW 2D 6L K 4.6D ZK NL CR3	86.WHA02.003
SCREW	SCREW 2D 10L K 4.2D NI NL	86.WHA02.004
SCREW	SCREW 3.0D 3.0L K 4.9D NI	86.WHA02.005

Model Definition and Configuration

Model	RO	Country	Acer Part No	Description	CPU
ENBFXS-742G25Mn	EMEA	UK	LX.BGH02.011	ENBFXS-742G25Mn W7HP64BTGB1 UMACKk4 2*1G/250/6L2.8/5R/ CBSD_bgn_0.3D_BAG_GEk_EN13 BUTTERFLY_XS-EV-001UK	CM74 3B
ENBFXS-234G32Mn	EMEA	Portugal	LX.BGH02.005	ENBFXS-234G32Mn W7HP64BTPT1 UMACKk4 2*2G/320/6L2.8/5R/ CB_bgn_0.3D_BAG_XSync_GEk_PT4 3 BUTTERFLY_XS-EU-001PT	CMS U230 0B
ENBFXS-233G32Mn	EMEA	France	LX.BGH02.010	ENBFXS-233G32Mn W7HP64BTFR1 UMACKk4 1G+2G/320/6L2.8/5R/ CB_bgn_0.3D_GEk_FR51 BUTTERFLY_XS-EV-010FR	CMS U230 0B
ENBFXS-741G16Mn	EMEA	France	LX.BGH02.009	ENBFXS-741G16Mn W7HP64BTFR1 UMACKk4 1*1G/160/6L2.8/5R/ CB_bgn_0.3D_GEk_FR51 BUTTERFLY_XS-EV-001FR	CM74 3B
ENBFXS-414G32Mn	EMEA	France	LX.BGH02.008	ENBFXS-414G32Mn W7HP64BTFR1 UMACKk4 2*2G/320/6L2.8/5R/ CB_bgn_0.3D_GEk_FR51 BUTTERFLY_XS-EU-020FR	PMD SU41 00B
ENBFXS-233G25Mn	EMEA	Italy	LX.BGH02.007	ENBFXS-233G25Mn W7HP64BTIT1 UMACKk4 1G+2G/250/BT/6L2.8/5R/ CB_bgn_0.3D_GEk_IT71 BUTTERFLY_XS-EV-001IT	CMS U230 0B
ENBFXS-232G32Mn	EMEA	Switzerland	LX.BGH02.006	ENBFXS-232G32Mn W7HP64BTCH1 UMACKk4 1*2G/320/6L2.8/5R/ CB_bgn_0.3D_GEk_SW23 BUTTERFLY_XS-EV-133CH	CMS U230 0B
ENBFXS-412G25Mn	WW	WW	S2.BGH02.003	ENBFXS-412G25Mn W7HP64BWW2 UMACKk4 2*1G/250/BT/6L2.8/5R/ CB_bgn_0.3D_GEk_EN11	PMD SU41 00B
ENBFXS-232G16Mi	EMEA	Russia	LX.BGH02.004	ENBFXS-232G16Mi W7HP64RUBTRU2 UMACKk4 1*2G/ 160/BT/6L2.2/5R/ CB_bg_0.3D_GEk_RU41 BUTTERFLY_XS-EV-001RU	CMS U230 0B
ENBFXS-232G25Mn	EMEA	Czech	LX.BGH02.003	ENBFXS-232G25Mn W7HP64BTCZ2 UMACKk4 1*2G/250/BT/6L2.8/5R/ CB_bgn_0.3D_BAG_GEk_SK11 BUTTERFLY_XS-EV-105CZ	CMS U230 0B
ENBFXS-412G25Mn	EMEA	Czech	LX.BGH02.002	ENBFXS-412G25Mn W7HP64BTCZ2 UMACKk4 1*2G/250/BT/6L2.8/5R/ CB_bgn_0.3D_BAG_GEk_CS43 BUTTERFLY_XS-EU-120CZ	PMD SU41 00B
ENBFXS-233G32Mn	EMEA	Czech	LX.BGH02.001	ENBFXS-233G32Mn W7HP64BTCZ2 UMACKk4 1G+2G/320/BT/6L2.8/5R/ CB_bgn_0.3D_BAG_GEk_CS43 BUTTERFLY_XS-EV-110CZ	CMS U230 0B

Model	RO	Country	Acer Part No	Description	CPU
ENBFXS-412G25Mn	WW	WW	S2.BGH02.001	ENBFXS-412G25Mn W7HP64BWW2 UMACkk4 2*1G/250/BT/6L2.8/5R/CB_bgn_0.3D_GEk_EN11	PMD SU41 00B
ENBFXS-412G25Mn	WW	WW	S2.BGH02.002	ENBFXS-412G25Mn W7HP64BWW2 UMACkk4 2*1G/250/BT/6L2.2/5R/CBSD_bgn_0.3D_GEk_EN11	PMD SU41 00B
ENBFXS-412G25Mn	WW	WW	S2.BGK02.002	ENBFXS-412G25Mn W7HP64BWW2 UMACrr4 2*1G/250/BT/6L2.8/5R/CB_bgn_0.3D_GEr_EN11	PMD SU41 00B
ENBFXS-412G25Mn	WW	WW	S2.BGK02.001	ENBFXS-412G25Mn W7HP64BWW2 UMACrr4 2*1G/250/BT/6L2.2/5R/CB_bgn_0.3D_GEk_EN11	PMD SU41 00B

Model	LCD	Memory 1	Memory 2	Wireless LAN1	Bluetooth	Battery
ENBFXS-742G25Mn	NLED 11.6W SVGA G	SO1GBIII10	SO1GBIII10	INT1000H	N	6CELL2.8
ENBFXS-234G32Mn	NLED 11.6W XGAG	SO2GBIII10	SO2GBIII10	INT1000H	N	6CELL2.8
ENBFXS-233G32Mn	NLED 11.6W XGAG	SO1GBIII10	SO2GBIII10	INT1000H	N	6CELL2.8
ENBFXS-741G16Mn	NLED 11.6W XGAG	SO1GBIII10	N	INT1000H	N	6CELL2.8
ENBFXS-414G32Mn	NLED 11.6W XGAG	SO2GBIII10	SO2GBIII10	INT1000H	N	6CELL2.8
ENBFXS-233G25Mn	NLED 11.6W XGAG	SO1GBIII10	SO2GBIII10	INT1000H	BT 2.1	6CELL2.8
ENBFXS-232G32Mn	NLED 11.6W XGAG	SO2GBIII10	N	INT1000H	N	6CELL2.8
ENBFXS-412G25Mn	NLED 11.6W XGAG	SO1GBIII10	SO1GBIII10	INT1000H	BT 2.1	6CELL2.8
ENBFXS-232G16Mi	NLED 11.6W XGAG	SO2GBIII10	N	INT1000H_BG	BT 2.1	6CELL2.2
ENBFXS-232G25Mn	NLED 11.6W XGAG	SO2GBIII10	N	INT1000H	BT 2.1	6CELL2.8
ENBFXS-412G25Mn	NLED 11.6W XGAG	SO2GBIII10	N	INT1000H	BT 2.1	6CELL2.8
ENBFXS-233G32Mn	NLED 11.6W XGAG	SO1GBIII10	SO2GBIII10	INT1000H	BT 2.1	6CELL2.8

Model	LCD	Memory 1	Memory 2	Wireless LAN1	Bluetooth	Battery
ENBFXS-412G25Mn	NLED 11.6W SVGA G	SO1GBIII10	SO1GBIII10	INT1000H	BT 2.1	6CELL2.8
ENBFXS-412G25Mn	NLED 11.6W SVGA G	SO1GBIII10	SO1GBIII10	INT1000H	BT 2.1	6CELL2.2
ENBFXS-412G25Mn	NLED 11.6W XGAG	SO1GBIII10	SO1GBIII10	INT1000H	BT 2.1	6CELL2.8
ENBFXS-412G25Mn	NLED 11.6W SVGA G	SO1GBIII10	SO1GBIII10	INT1000H	BT 2.1	6CELL2.2

Test Compatible Components

This computer's compatibility is tested and verified by Acer's internal testing department. All of its system functions are tested under Windows® 7 environments with backwards compatibility to Windows® XP.

Refer to the following lists for components, adapter cards, and peripherals which have passed these tests. Regarding configuration, combination and test procedures, please refer to the TBD>NAV50 series Compatibility Test Report released by the Acer Mobile System Testing Department.

BRAND	Type	Description
3G		
	UNDP-1	3G UNDP-1
A cover		
	Black IMR	Black IMR
	Red IMR	Red IMR
Accessory		
	SJM12_MS GW Protection Bag	Accessory SJM12_MS +SJM13_MS GW Protection Bag
	USB Bridge Dongle	Accessory USB Bridge dongle device - XSYNC
Gateway	Placarded 11inch Netbook Bag black	Placarded Accessory Placarded 11" Netbook Bag Black
Adapter		
DELTA	30W	Adapter DELTA 30W 19V 1.7x5.5x11 Black ADP-30JH BA LF
HIPRO	30W	Adapter HIPRO 30W 19V 1.7x5.5x11 Black HP-A0301R3 B1LF (Rev.03, w/Korean safety logo) LF
LITE-ON	30W	Adapter LITE-ON 30W 19V 1.7x5.5x11 Black PA-1300-04AC LF
Audio Codec		
Realtek	ALC269X	Realtek Audio Codec ALC269X
B cover		
	Mirror w/Camera	Mirror w/Camera
Battery		
PANASONI C	6CELL2.2	Battery PANASONIC UM-2009E Li-Ion 3S2P PANASONIC 6 cell 4400mAh Main COMMON ID:UM09E51
SANYO	6CELL2.2	Battery SANYO UM-2009E Li-Ion 3S2P SANYO 6 cell 4400mAh Main COMMON ID: UM09E31
SANYO	6CELL2.8	Battery SANYO UM-2009E Li-Ion 3S2P SANYO 6 cell 5600mAh Main COMMON ID:UM09E36
SIMPLO	6CELL2.8	Battery SIMPLO UM-2009E Li-Ion 3S2P LGC 6 cell 5600mAh Main COMMON ID:UM09E78
SIMPLO	6CELL2.2	Battery SIMPLO UM-2009E Li-Ion 3S2P PANASONIC 6 cell 4400mAh Main COMMON ID:UM09E71
SIMPLO	6CELL2.2	Battery SIMPLO UM-2009E Li-Ion 3S2P SAMSUNG 6 cell 4400mAh Main COMMON ID:UM09E75

BRAND	Type	Description
SIMPLO	6CELL2.8	Battery SIMPLO UM-2009E Li-Ion 3S2P SAMSUNG 6 cell 5600mAh Main COMMON ID:UM09E70
Bluetooth		
Foxconn	BT 2.1	Foxconn Bluetooth BRM 2046 BT2.1 (T60H928.33) f/w:861
Camera		
Chicony	0.3M LDV	Chicony Camera Lilac_2G
Liteon	0.3M LDV	Liteon Camera Lily_2G
Suyin	0.3M LDV	Suyin Camera Rose_2G
Card Reader		
	5 in 1-Build in	5 in 1-Build in MS, MS Pro, SD, SC, XD
INTEL	CM743B	CPU Intel Celeron 743 BGA 1M 800
CPU		
INTEL	CMSU2300B	CPU Intel Celeron SU2300 BGA 1.2G 1M 800 10W R-0
INTEL	PMSU4100B	CPU Intel Core2Dual SU4100 2M 800
HDD		
HGST	N160GB5.4KS	HDD HGST 2.5" 5400rpm 160GB HTS545016B9A300 Panther B SATA LF F/W:C60F Disk imbalance criteria = 0.014g-cm
HGST	N250GB5.4KS	HDD HGST 2.5" 5400rpm 250GB HTS545025B9A300 Panther B SATA LF F/W:C60F Disk imbalance criteria = 0.014g-cm
HGST	N320GB5.4KS	HDD HGST 2.5" 5400rpm 320GB HTS545032B9A300 Panther B SATA LF F/W:C60F Disk imbalance criteria = 0.014g-cm
SEAGATE	N160GB5.4KS	HDD SEAGATE 2.5" 5400rpm 160GB ST9160314AS Wyatt SATA LF F/W:0001SDM1
SEAGATE	N250GB5.4KS	HDD SEAGATE 2.5" 5400rpm 250GB ST9250315AS Wyatt SATA LF F/W:0001SDM1
SEAGATE	N320GB5.4KS	HDD SEAGATE 2.5" 5400rpm 320GB ST9320325AS Wyatt SATA LF F/W:0001SDM1
TOSHIBA	N160GB5.4KS	HDD TOSHIBA 2.5" 5400rpm 160GB MK1655GSX Libra SATA LF F/W: FG011J
TOSHIBA	N250GB5.4KS	HDD TOSHIBA 2.5" 5400rpm 250GB MK2555GSX Libra SATA LF F/W:FG001J
TOSHIBA	N320GB5.4KS	HDD TOSHIBA 2.5" 5400rpm 320GB MK3263GSX SATA 8MB 68P LF F/W:FG020J
WD	N160GB5.4KS	HDD WD 2.5" 5400rpm 160GB WD1600BEVT-22ZCT0 ML160 SATA LF F/W:11.01A11
WD	N250GB5.4KS	HDD WD 2.5" 5400rpm 250GB WD2500BEVT-22ZCT0 ML160 SATA LF F/W:11.01A11
WD	N320GB5.4KS	HDD WD 2.5" 5400rpm 320GB WD3200BEVT-22ZCT0 ML160 SATA LF F/W:11.01A11
Keyboard		
GATEWAY	GP-1T	Keyboard GATEWAY GP-1T SJM11 Internal 11 Standard Black NONE Texture
LAN		
Atheros	AR8131L	Atheros AR8131L
LCD		

BRAND	Type	Description
AUO	NLED11.6WSVGAG	LED LCD AUO 11.6" WSVGA Glare B116AW02 V0 LF 200nit 16ms 500:1
AUO	NLED11.6WXGAG	LED LCD AUO 11.6" WXGA Glare B116XW02 V0 1A (3G) LF 200nit 8ms 500:1
CMO	NLED11.6WSVGAG	LED LCD CMO 11.6" WSVGA Glare N116L6-L02 LF 200nit 16ms 500:1
CMO	NLED11.6WXGAG	LED LCD CMO 11.6" WXGA Glare N116B6-L02 C2 LF 200nit 10ms 500:1
LPL	NLED11.6WSVGAG	LED LCD LPL 11.6" WSVGA Glare LP116WSA-TLA1 LF 200nit 16ms
LPL	NLED11.6WXGAG	LED LCD LPL 11.6" WXGA Glare LP116WH1-TLA1 LF 200nit 8ms 500:1
SAMSUNG	NLED11.6WSVGAG	LED LCD SAMSUNG 11.6" WSVGA Glare LTN116NT01-A01 LF 200nit 16ms 300:1
SAMSUNG	NLED11.6WXGAG	LED LCD SAMSUNG 11.6" WXGA Glare LTN116AT01-A01 LF 200nit 8ms
MEM		
A-DATA	SO2GBIII10	Memory A-DATA SO-DIMM DDRIII 1066 2GB HY7YG1B1674ZM LF 128*8 0.065um
ELPIDA	SO1GBIII10	Memory ELPIDA SO-DIMM DDRIII 1066 1GB EBJ10UE8BDS0-AE-F LF 128*8 0.065um
ELPIDA	SO2GBIII10	Memory ELPIDA SO-DIMM DDRIII 1066 2GB EBJ21UE8BDS0-AE-F LF 128*8 0.065um
HYNIX	SO1GBIII10	Memory HYNIX SO-DIMM DDRIII 1066 1GB HMT112S6BFR6C-G7 N0 LF 64*16 0.055um
HYNIX	SO2GBIII10	Memory HYNIX SO-DIMM DDRIII 1066 2GB HMT125S6BFR8C-G7 N0 LF 128*8 0.055um
MICRON	SO1GBIII10	Memory MICRON SO-DIMM DDRIII 1066 1GB MT8JSF12864HZ-1G1F1 LF 128*8 0.065um
SAMSUNG	SO1GBIII10	Memory SAMSUNG SO-DIMM DDRIII 1066 1GB M471B2873EH1-CF8 LF 64*16 0.055um
SAMSUNG	SO2GBIII10	Memory SAMSUNG SO-DIMM DDRIII 1066 2GB M471B5673EH1-CF8 LF 128*8 0.055um
NB Chipset		
INTEL	GS45	NB Chipset Intel CS GS45NB
ODD		
HLDS	NSM8XS9.5	ODD HLDS Super-Multi DRIVE 9.5mm Tray DL 8X GU10N LF W/O bezel SATA (HF + Windows 7)
PANASONI C	NSM8XS9.5	ODD PANASONIC Super-Multi DRIVE 9.5mm Tray DL 8X UJ892 LF W/O bezel SATA GBAS2.0, (HF + Windows7)
TOSHIBA	NSM8XS9.5	ODD TOSHIBA Super-Multi DRIVE 9.5mm Tray DL 8X TS-U633A LF W/O bezel AC02 SATA (Windows 7)
TOSHIBA	NSM8XS9.5	ODD TOSHIBA Super-Multi DRIVE 9.5mm Tray DL 8X TS-U633F LF W/O bezel SATA (HF + Windows 7)
SB Chipset		
INTEL	ICH9M-SFFE	SB Chipset Intel CS AM82801IUX MM#898134
Software		
	NIS	Antivirus application NIS

BRAND	Type	Description
VGA Chip		
None	UMA	UMA (Intel)
WiFi Antenna		
WNC	PIFA	PIFA
Wireless LAN		
INTEL	INT1000H	Lan Intel WLAN 112BN.HMWG MM#903341

Online Support Information

This section describes online technical support services available to help you repair your Acer Systems.

If you are a distributor, dealer, ASP or TPM, please refer your technical queries to your local Acer branch office. Acer Branch Offices and Regional Business Units may access our website. However some information sources will require a user i.d. and password. These can be obtained directly from Acer CSD Taiwan.

Acer's Website offers you convenient and valuable support resources whenever you need them.

In the Technical Information section you can download information on all of Acer's Notebook, Desktop and Server models including:

- Service guides for all models
- User's manuals
- Bios updates
- Software utilities
- Spare parts lists
- TABs (Technical Announcement Bulletin)

For these purposes, we have included an Acrobat File to facilitate the problem-free downloading of our technical material.

Also contained on this website are:

- Detailed information on Acer's International Traveler's Warranty (ITW)
- Returned material authorization procedures
- An overview of all the support services we offer, accompanied by a list of telephone, fax and email contacts for all your technical queries.

We are always looking for ways to optimize and improve our services, so if you have any suggestions or comments, please do not hesitate to communicate these to us.

A

- AFLASH Utility 35
- Antennas
 - Removing 98

B

- Battery Pack
 - Removing 46
 - Replacing 131
- BIOS
 - vendor 17
 - Version 17
- BIOS Utility 27–35
 - Boot 33
 - Exit 34
 - Navigating 27
 - Onboard Device Configuration 31
 - Power 33
 - Save and Exit 34
 - Security 30
 - System Security 34
- Board Layout
 - Top View 155

C

- Camera Module
 - Removing 92
 - Replacing 105
- Common Problems 134
- CPU
 - Removing 89
 - Replacing 108
- CPU Fan
 - Removing 87
 - Replacing 109

D

- DIMM Modules
 - Removing 51
 - Replacing 128
- Display 4

E

- EasyTouch Failure 148

- External Module Disassembly
 - Flowchart 45

F

- Features 1
- Flash Utility 35
- FPC Cable
 - Removing 95
 - Replacing 103
- FRU (Field Replaceable Unit) List 161

H

- Hard Disk Drive Modules
 - Replacing 127
- HDD1
 - Removing 54
 - Replacing 127
- HDD2
 - Removing 56
 - Replacing 127
- HDTV Switch Failure 149
- Hot Keys 13

I

- Indicators 11
- Intermittent Problems 150
- Internal Microphone Failure 140
- Internal Speaker Failure 138

J

- Jumper and Connector Locations 155

K

- Keyboard
 - Removing 63
 - Replacing 123
- Keyboard Failure 137

L

- LCD Bezel
 - Removing 91
 - Replacing 106

- LCD Brackets
 - Removing 95
 - Replacing 103
- LCD Failure 137
- LCD Module
 - Removing 65
 - Replacing 120
- LCD Module Disassembly
 - Flowchart 90
- LCD Module Reassembly Procedure 100
- LCD Panel
 - Removing 93
 - Replacing 103
- LED Board
 - Removing 76
 - Replacing 115
- Lower Covers
 - Removing 48
 - Replacing 129

M

- Main Module Reassembly Procedure 108
- Main Unit Disassembly
 - Flowchart 58
- Mainboard
 - Removing 84
 - Replacing 111
- Media Board
 - Removing 62
 - Replacing 124
- Media Board FFC
 - Removing 75
 - Replacing 115
- Memory Check 134
- MIC Board
 - Replacing 100
- Microphone Module
 - Removing 97
- Model Definition 176
- Modem Board
 - Removing 80
 - Replacing 113
- Modem Cable
 - Removing 85
 - Replacing 110
- Modem Failure 145

N

- No Display Issue 135

O

- ODD Failure 142
- ODD Module
 - Removing 49
 - Replacing 129
- Online Support Information 189

P

- Panel 5
 - Bottom 8
 - left 5
- PC Card 11
- Power Board
 - Removing 94
 - Replacing 100
- Power On Failure 134
- Primary HDD
 - Removing 54
 - Replacing 127

R

- RJ-11 Jack
 - Removing 85
 - Replacing 110
- RTC Battery
 - Removing 79

S

- SD Dummy Card
 - Removing 47
 - Replacing 131
- Secondary HDD
 - Removing 56
 - Replacing 127
- Speaker Module
 - Removing 77
 - Replacing 114
- Switch Cover
 - Removing 59
 - Replacing 125
- System
 - Block Diagram 4

T

Test Compatible Components 183

Thermal Grease 108

Thermal Module

Removing 88

Replacing 108

Thermal Unit Failure 148

TouchPad Bracket

Removing 74

Replacing 116

TouchPad Failure 138

Troubleshooting

Built-in KB Failure 137

EasyTouch Buttons 148

HDTV Switch 149

Internal Microphone 140

Internal Speakers 138

LCD Failure 137

Modem 145

No Display 135

ODD 142

Other Failures 149

Power On 134

Thermal Unit 148

TouchPad 138

WLAN 146

U

Undetermined Problems 150

Upper Cover

Removing 70

Replacing 116

USB Board

Removing 82

Replacing 112

utility

BIOS 27–35

W

Windows 2000 Environment Test 184

Wireless Function Failure 146

WLAN Module

Removing 52

Replacing 128

