

Dell™ Inspiron™ XPS and Inspiron 9100 Service Manual

[Before You Begin](#)

[Memory Module, Mini PCI Card, and Devices](#)

[System Components](#)

[Subwoofer](#)

[Bluetooth™ Card](#)

[Hard Drive](#)

[Fans](#)

[Hinge Covers](#)

[Keyboard](#)

[Modem](#)

[Reserve Battery](#)

[Display Assembly and Display Latch](#)

[Keyboard Bracket](#)

[Palm Rest](#)

[Video Card](#)

[Microprocessor Thermal-Cooling Assembly](#)

[Microprocessor Module](#)

[Speakers](#)

[Display Release Latch](#)

[System Board](#)

[Flashing the BIOS](#)

[Pin Assignments for I/O Connectors](#)

Notes, Notices, and Cautions



NOTE: A NOTE indicates important information that helps you make better use of your computer.



NOTICE: A NOTICE indicates either potential damage to hardware or loss of data and tells you how to avoid the problem.





[Back to Contents Page](#)

Before You Begin

Dell™ Inspiron™ XPS and Inspiron 9100 Service Manual

- [Preparing to Work Inside the Computer](#)
 - [Recommended Tools](#)
 - [Computer Orientation](#)
 - [Screw Identification](#)
-

Preparing to Work Inside the Computer

-  **CAUTION:** Only a certified service technician should perform repairs on your computer. Damage due to servicing that is not authorized by Dell is not covered by your warranty. Read and follow the safety instructions in the *Owner's Manual* that came with the computer.
-  **CAUTION:** To prevent static damage to components inside your computer, discharge static electricity from your body before you touch any of your computer's electronic components. You can do so by touching an unpainted metal surface.
-  **CAUTION:** Handle components and cards with care. Do not touch the components or contacts on a card. Hold a card by its edges or by its metal mounting bracket. Hold a component such as a microprocessor by its edges, not by its pins.
-  **NOTICE:** When you disconnect a cable, pull on its connector or on its strain-relief loop, not on the cable itself. Some cables have a connector with locking tabs; if you are disconnecting this type of cable, press in on the locking tabs before you disconnect the cable. As you pull connectors apart, keep them evenly aligned to avoid bending any connector pins. Also, before you connect a cable, ensure that both connectors are correctly oriented and aligned.
-  **NOTICE:** To avoid damaging the computer, perform the following steps before you begin working inside the computer.

1. Ensure that the work surface is flat and clean to prevent scratching the computer cover.
2. Save any work in progress and exit all open programs.
3. Turn off the computer and all attached devices.



NOTE: Ensure that the computer is off and not in a power management mode. If you cannot shut down the computer using the computer operating system, press and hold the power button for 4 seconds.

4. If the computer is connected to a docking device (docked), undock it.
5. Disconnect the computer from the electrical outlet.
6. To avoid possible damage to the system board, wait 10 to 20 seconds and then disconnect any attached devices.
7. Disconnect all other external cables from the computer.
8. Remove any installed PC Cards from the PC Card slot.
9. Close the display and turn the computer upside down on a flat work surface.



NOTICE: To avoid damaging the system board, you must remove the main battery before you service the computer.

10. Slide and hold the battery-bay latch release on the bottom of the computer, and then remove the battery from the bay.

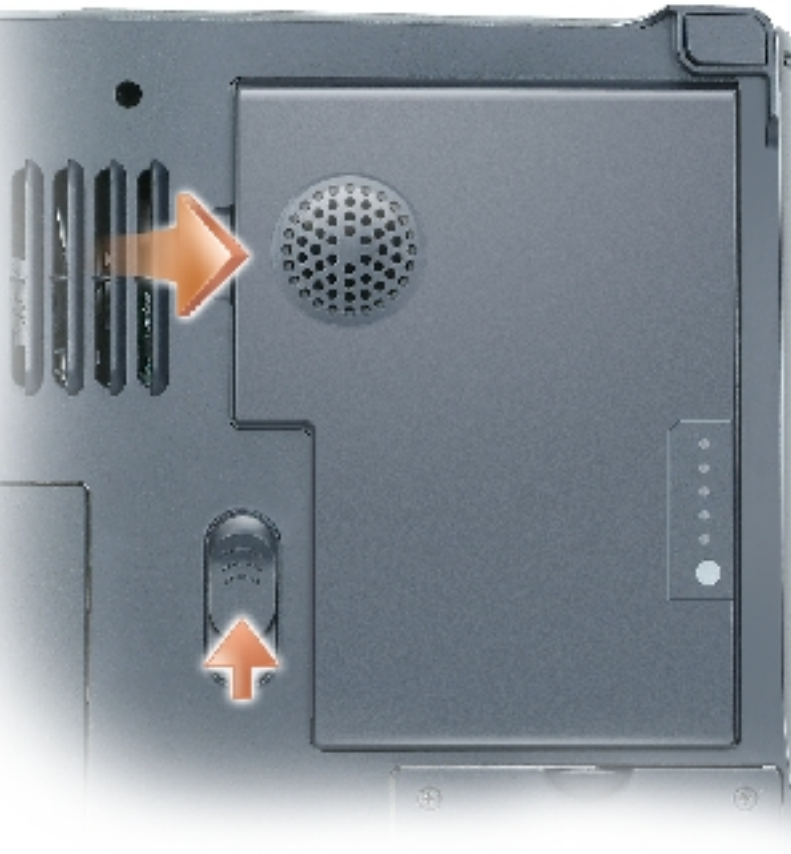

11. Remove any installed [memory modules](#), [Mini PCI cards](#), and [devices](#), including a second battery if one is installed.
 12. Remove the [hard drive](#).
-

Recommended Tools

The procedures in this manual require the following tools:

- #1 Phillips screwdriver
- ¼-inch flat-blade screwdriver
- Small plastic scribe
- Flash BIOS update program floppy disk or CD

Computer Orientation



1	back
2	right
3	front
4	left

Screw Identification

When you are removing and replacing components, photocopy "[Screw Identification](#)" as a tool to lay out and keep track of the screws. The placemat provides the number

of screws and their sizes.



M2 x 3 mm



M2.5 x 3 mm



M3 x 3 mm



M2.5 x 4 mm

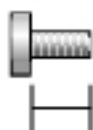

M2.5 x 5 mm



M2.5 x 6 mm

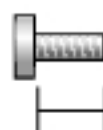

M2.5 x 8 mm

Hard Drive:

(1 each)



M3 x 3 mm

Fan 2

(1 each)

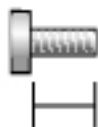

M2.5 x 6 mm

Keyboard:

(2 each)



M2.5 x 3 mm

Modem:

(1 each)



M2.5 x 3 mm

Display Assembly:

(4 each)

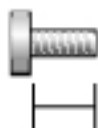

M2.5 x 6 mm

Display Bezel:

(display bumpers, 6 each;
screw covers, 2 each)

(6 each)

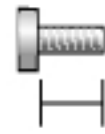

M2.5 x 6 mm

(2 each, shoulder type)

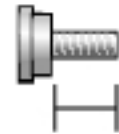

M2.5 x 6 mm

Display Panel:

(8 each)



M2 x 3 mm

Display Latch:

(2 each)



M2.5 x 4 mm

Keyboard Bracket:

(4 each)

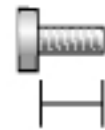

M2.5 x 6 mm

Display Ground Screw:

(1 each)



M2 x 3 mm

Palm Rest:

(3 each)

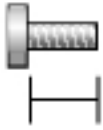

M2.5 x 8 mm

(4 each)

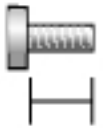

M2.5 x 6 mm

Video Card:

(4 each)

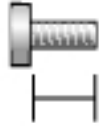

M2.5 x 6 mm

Speakers:

(3 each)



M2.5 x 6 mm

Display Release Latch:

(2 each)

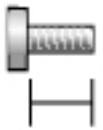

M2.5 x 6 mm

System Board:

(6 each)

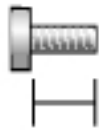

M2.5 x 6 mm

[Back to Contents Page](#)

[Back to Contents Page](#)

Memory Module, Mini PCI Card, and Devices

Dell™ Inspiron™ XPS and Inspiron 9100 Service Manual

- [Memory Module](#)
 - [Mini PCI Card](#)
 - [Devices](#)
-

Memory Module

 **CAUTION:** Before working inside your Dell™ computer, read the safety instructions in your *Owner's Manual*.

 **CAUTION:** To prevent static damage to components inside your computer, discharge static electricity from your body before you touch any of your computer's electronic components. You can do so by touching an unpainted metal surface.

 **NOTE:** Memory modules purchased from Dell are covered under your computer warranty.

 **NOTE:** This computer requires matched memory modules and therefore, it always has two identical memory modules.

1. Follow the instructions in "[Preparing to Work Inside the Computer](#)."
2. Turn the computer over, loosen the captive screw (labeled "M") from the memory module cover, and lift the cover.

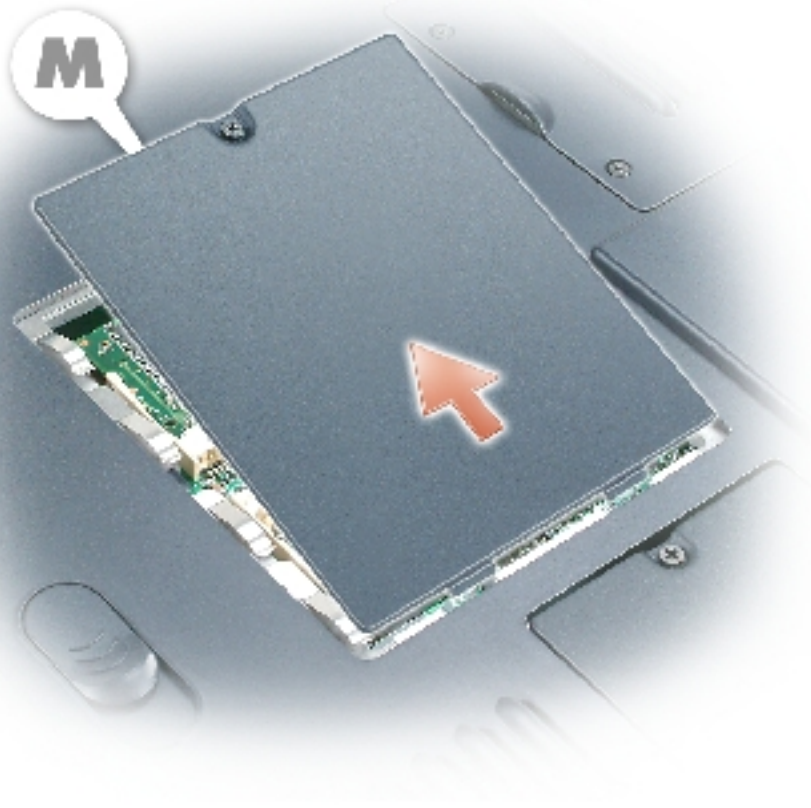

➔ **NOTICE:** To prevent damage to the memory module connector, do not use tools to spread the securing clips that secure the memory module.

3. If you are replacing a memory module, remove the existing module.

➔ **NOTICE:** Handle memory modules by their edges, and do not touch the components on a module.

- a. Use your fingertips to carefully spread apart the securing clips on each end of the memory module connector until the module pops up.
- b. Remove the module from the connector at a 45-degree angle.

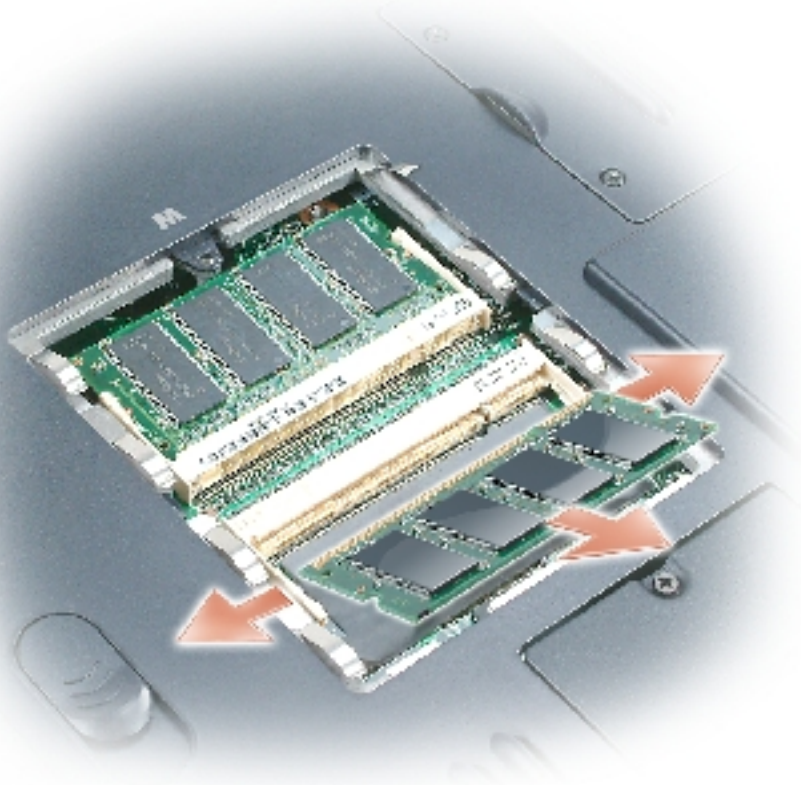

NOTICE: Ensure that memory modules are installed in both connectors and that they are of the same capacity. Install a memory module in the connector labeled "DIMM A" before you install a module in the connector labeled "DIMM B." Insert memory modules at a 45-degree angle to avoid damaging the connector.

4. Ground yourself and install the new memory module:

- a. Align the notch in the module edge connector with the tab in the connector slot.
- b. Slide the module firmly into the slot at a 45-degree angle, and rotate the module down until it clicks into place. If you do not feel the click, remove the module and reinstall it.

NOTE: If the memory module is not installed properly, the computer does not boot. No error message indicates this failure.

5. Replace the cover and screw.

- ➔ **NOTICE:** If the memory module cover is difficult to close, remove the module and reinstall it. Forcing the cover to close may damage your computer.

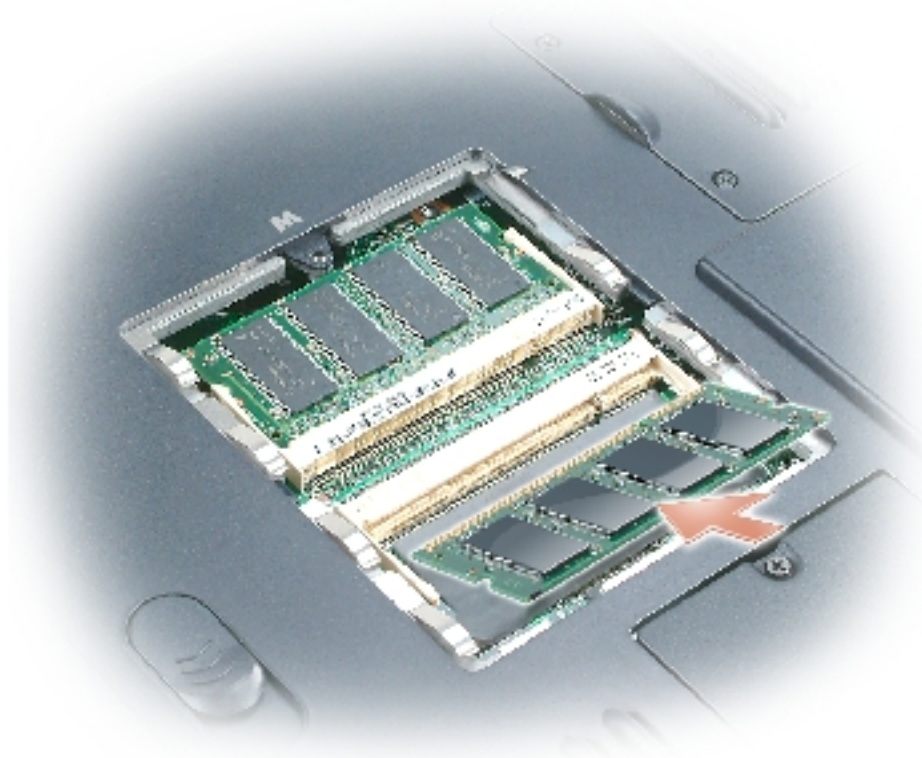

6. Insert the battery into the battery bay, or connect the AC adapter to your computer and an electrical outlet.
7. Turn on the computer.

As the computer boots, it detects the additional memory and automatically updates the system configuration information.

Mini PCI Card

 **CAUTION:** FCC rules strictly prohibit users from installing 5-GHz (802.11a, 802.11a/b, 802.11a/b/g) Wireless LAN Mini PCI cards. Under no circumstances should you install such a device. Only trained Dell service personnel are authorized to install a 5-GHz Wireless LAN Mini PCI card.

 **CAUTION:** If you are removing and/or installing a 2.4-GHz (802.11b, 802.11b/g) Mini PCI card, follow the instructions noted below. Only products approved for use in your portable computer may be installed. Approved Mini PCI cards may be purchased only from Dell.

 **CAUTION:** Before working inside your computer, read the safety instructions in your *Owner's Manual*.

 **NOTICE:** To avoid damaging the system board, you must remove the main battery before you begin working inside the computer.

 **NOTE:** 2.4-GHz Wireless LAN PC Cards may be removed and installed by the user.

If you ordered a Mini PCI card with your computer, the card is already installed.

1. Follow the instructions in "[Preparing to Work Inside the Computer](#)."
2. Turn over the computer.
3. Unscrew the captive screw labeled "C" and remove the Mini PCI card cover.



4. If a Mini PCI card is not already installed, go to [step 5](#). If you are replacing a Mini PCI card, remove the existing card:
 - a. Disconnect the antenna cables from the Mini PCI card.

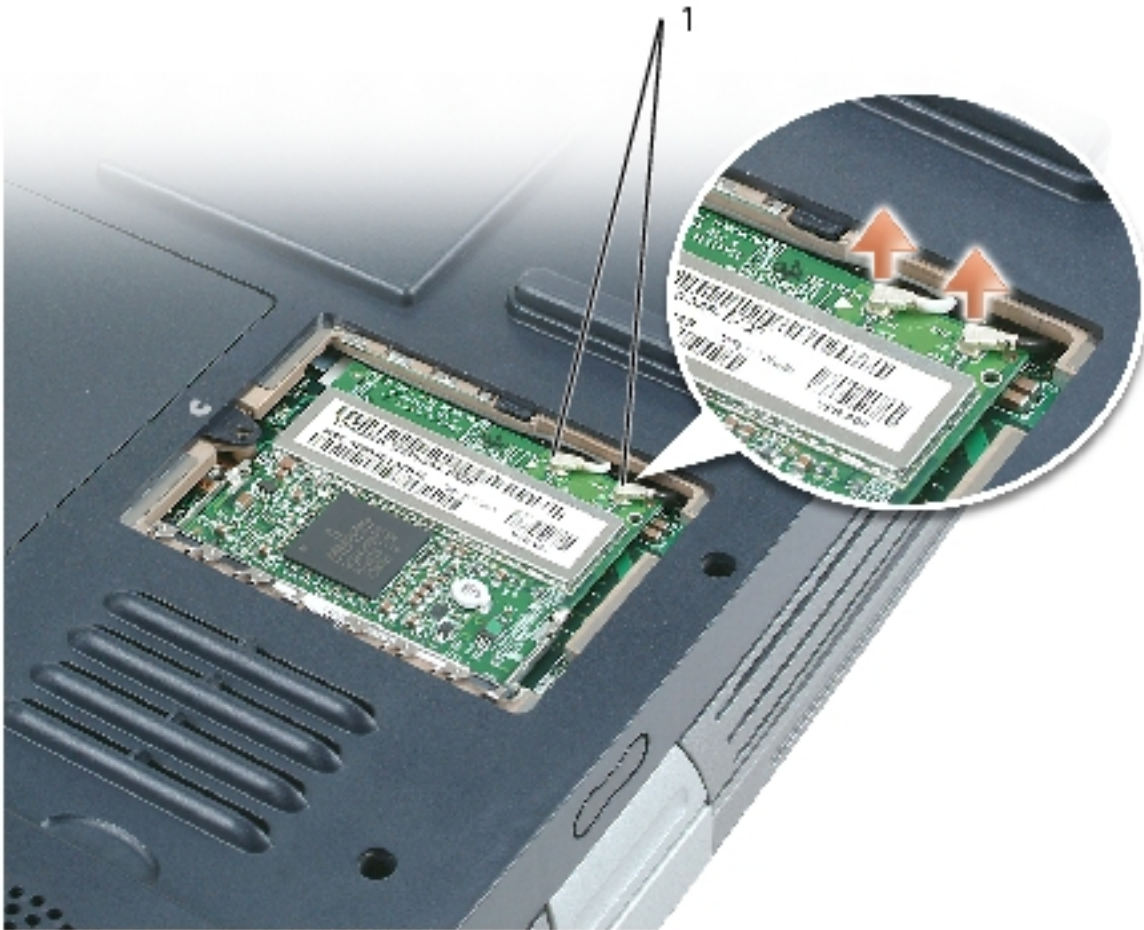

1 antenna cables (2)

NOTICE: To prevent damage to the Mini PCI card connector, do not use tools to spread the securing clips that secure the card.

- b. Release the Mini PCI card by spreading the metal securing tabs until the card pops up slightly.
- c. Lift the Mini PCI card out of its connector.

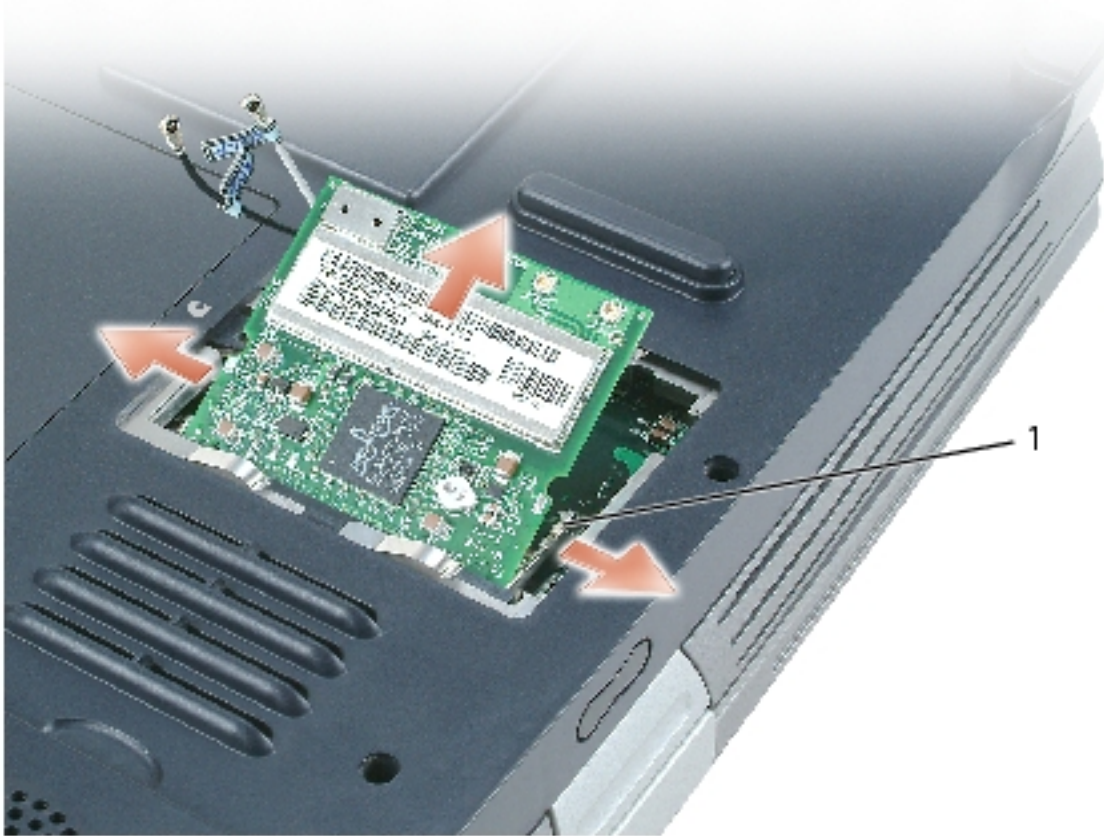

1 securing tabs

- ➔ **NOTICE:** To avoid damaging the antenna cables or the Mini PCI card, never place the cables under the card.
- ➔ **NOTICE:** The connectors are keyed to ensure correct insertion. If you feel resistance, check the connectors and realign the card.

5. Align the Mini PCI card with the connector at a 45-degree angle, and press the Mini PCI card into the connector until it clicks.



6. Connect the antenna cables to the Mini PCI card.

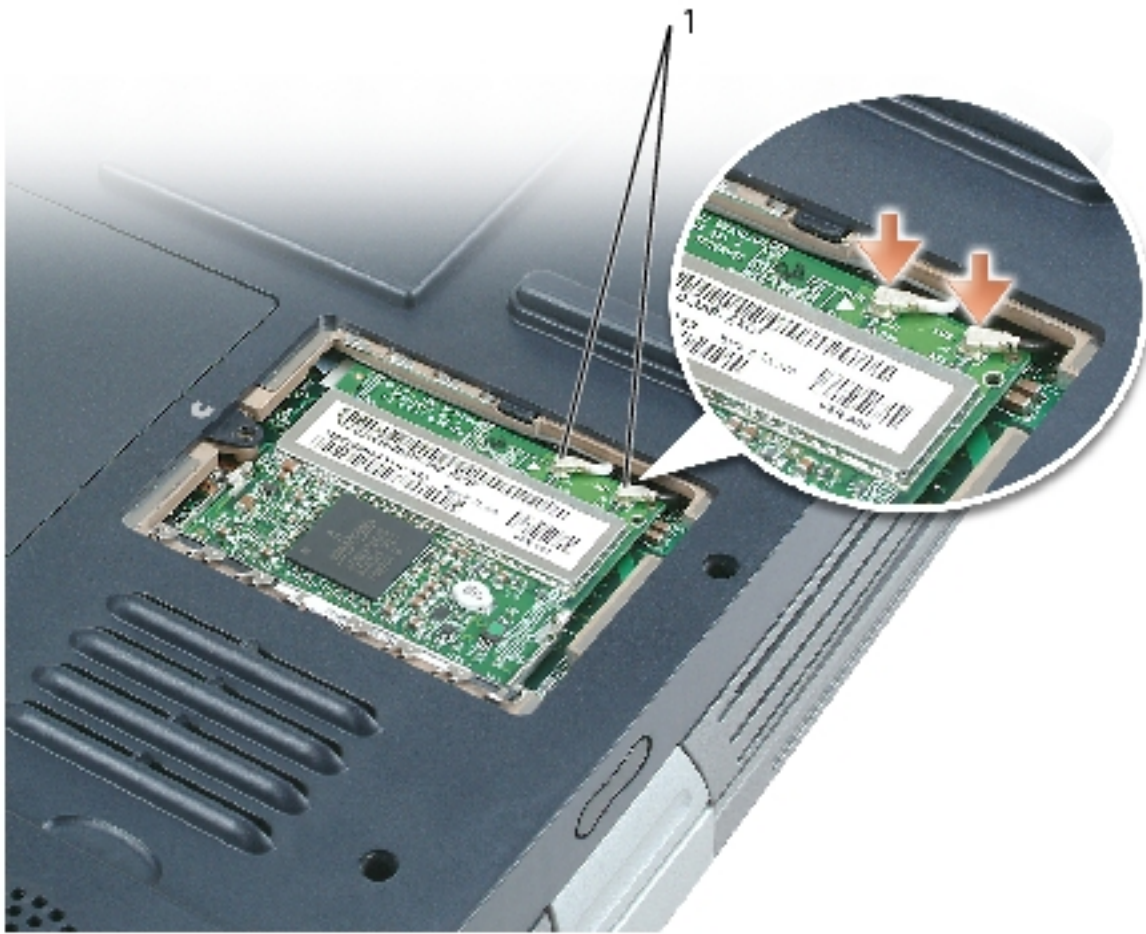

1 antenna cables

7. Replace the cover and tighten the captive screw.

Devices

Your computer ships with an optical drive installed in the module bay.

 **NOTICE:** Insert devices into the module bay before you dock and turn on the computer.

Removing and Installing Devices While the Computer Is Turned Off

NOTICE: To prevent damage to devices, store them in a safe, dry place when they are not installed in the computer. Avoid pressing down on them or placing heavy objects on top of them.

1. Press the device latch release.

The latch release ejects partway.



1	device latch release
---	----------------------

2. Pull the device out of the module bay.



1	module bay device
2	device latch release

3. Push the new device into the bay until it clicks.

Removing and Installing Devices While the Computer Is Running

1. Before ejecting the device, double-click the **Safely Remove Hardware** icon on the taskbar, click the device you want to eject, and click **Stop**.

➔ **NOTICE:** To prevent damage to devices, store them in a safe, dry place when they are not installed in the computer. Avoid pressing down on them or placing heavy objects on top of them.

2. Press the device latch release.

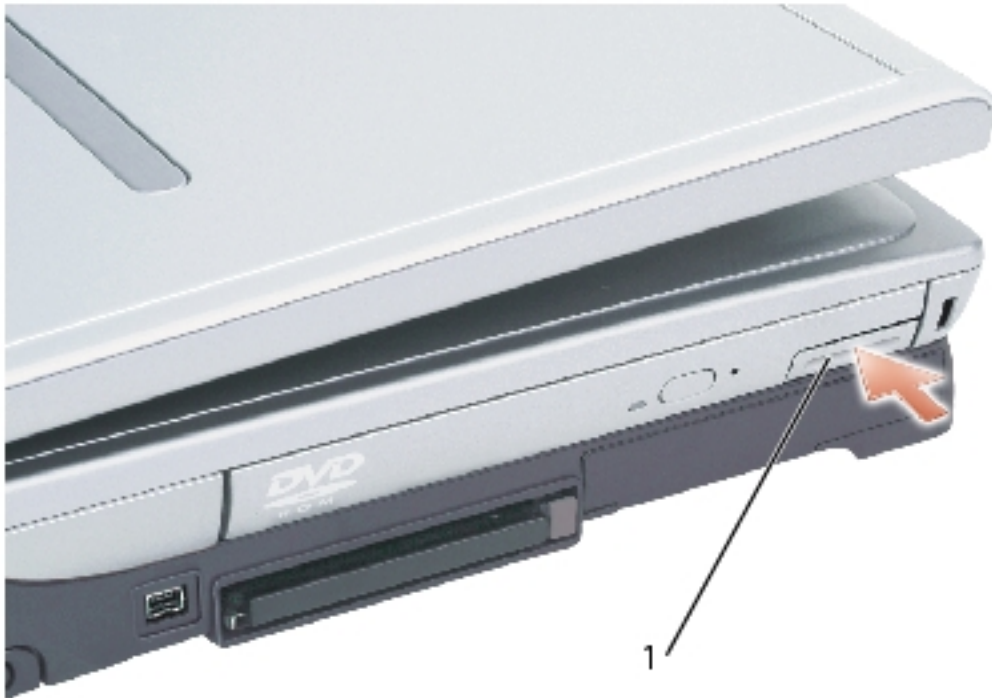

1	device latch release
---	----------------------

3. Pull the device out of the module bay.



1	module bay device
2	device latch release

4. Push the new device into the bay until it clicks.

The operating system automatically recognizes the device.

5. If necessary, enter your password to unlock your computer.

[Back to Contents Page](#)

[Back to Contents Page](#)

System Components

Dell™ Inspiron™ XPS and Inspiron 9100 Service Manual

- ➔ **NOTICE:** Only a certified service technician should perform repairs on your computer. Damage due to servicing that is not authorized by Dell is not covered by your warranty.
- ➔ **NOTICE:** Unless otherwise noted, each procedure in this document assumes that a part can be replaced by performing the removal procedure in reverse order.

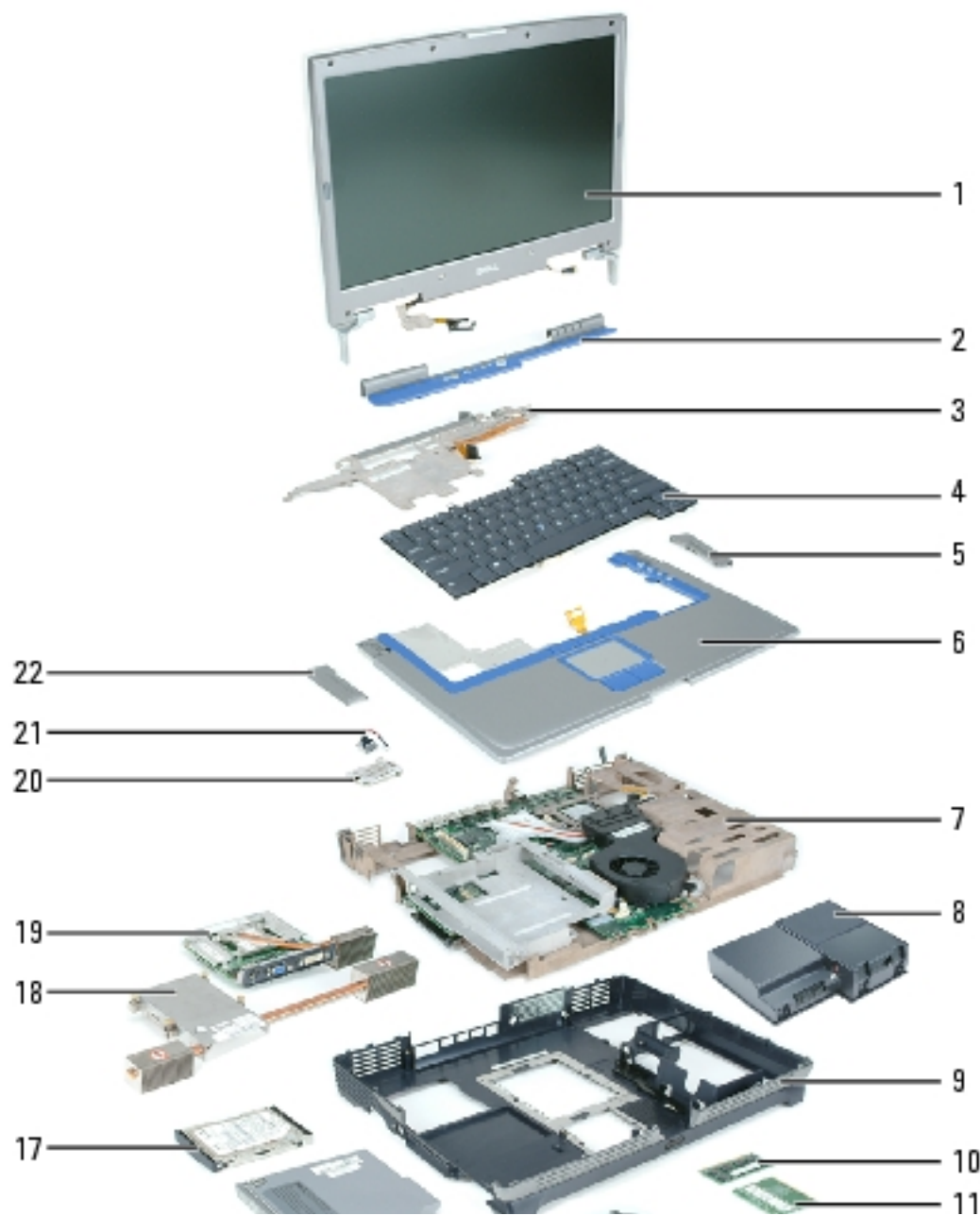



1	display assembly	12	fan 3
2	center hinge cover	13	speakers
3	keyboard bracket	14	display release latch
4	keyboard	15	fan 2
5	right hinge cover	16	CD drive
6	palm rest (with touch pad)	17	hard drive
7	system board	18	microprocessor thermal-cooling assembly
8	battery and subwoofer assembly	19	video card
9	bottom assembly	20	modem
10	memory	21	reserve battery
11	mini PCI card	22	left hinge cover

[Back to Contents Page](#)

[Back to Contents Page](#)

Subwoofer

Dell™ Inspiron™ XPS and Inspiron 9100 Service Manual

 **CAUTION:** Before performing the following procedures, read the safety instructions in your *Owner's Manual*.

 **NOTICE:** To avoid electrostatic discharge, ground yourself by using a wrist grounding strap or by periodically touching an unpainted metal surface (such as the back panel) on the computer.

If you ordered a subwoofer with your computer, it is already installed. To remove and replace a subwoofer:

1. Follow the instructions in "[Preparing to Work Inside the Computer](#)."
2. Remove the battery.

 **NOTICE:** To avoid damaging the system board, you must remove the main battery before you begin working inside the computer.

3. Remove the subwoofer from the battery:
 - a. Disconnect the subwoofer cable.
 - b. Use a small screwdriver or scribe to release the subwoofer from the compartment in the battery.

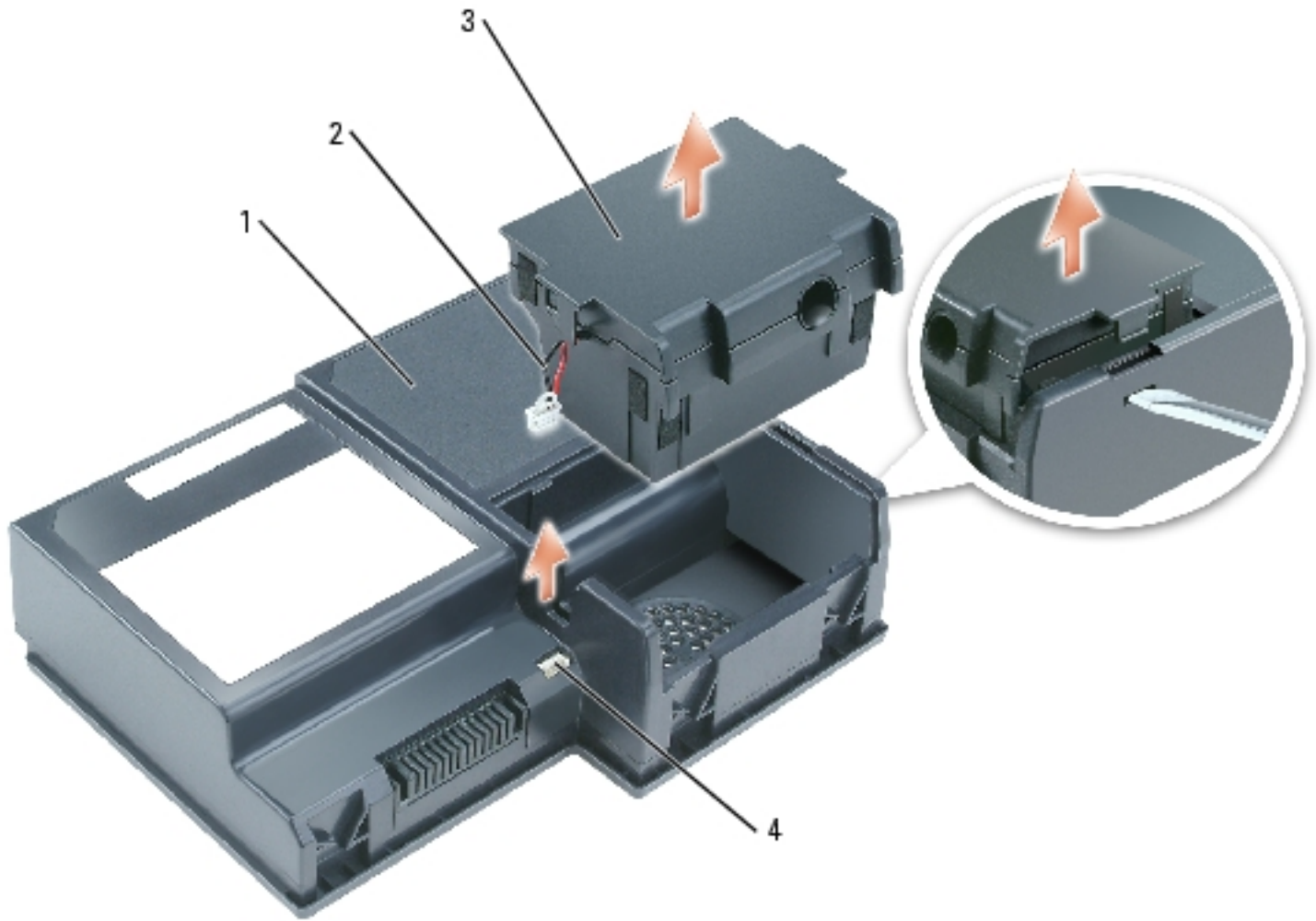

1	battery
2	cable
3	subwoofer
4	subwoofer cable connector

4. Insert the subwoofer into the compartment within the battery.

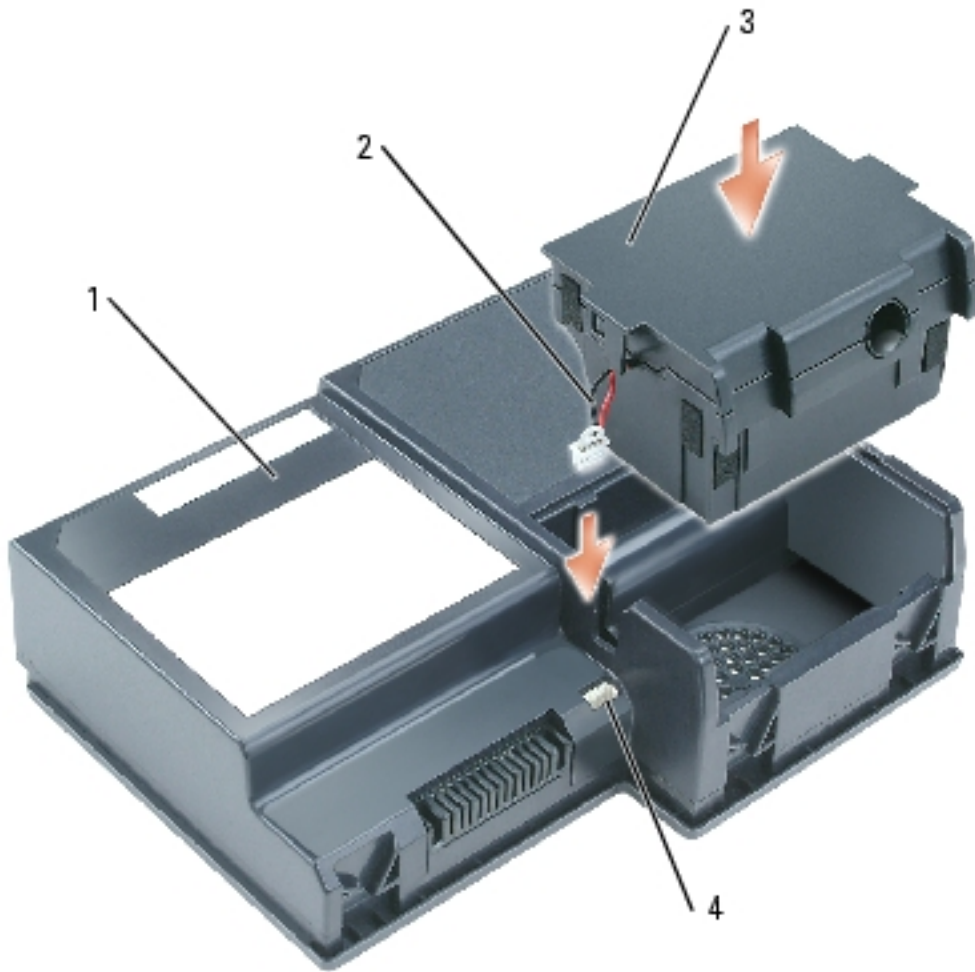

1	battery
2	cable
3	subwoofer
4	subwoofer cable connector

5. Connect the cable to the subwoofer connector.

6. Replace the battery in the battery bay.

[Back to Contents Page](#)

[Back to Contents Page](#)

Bluetooth™ Card

Dell™ Inspiron™ XPS and Inspiron 9100 Service Manual

 **CAUTION:** Before performing the following procedures, read the safety instructions in your *Owner's Manual*.

 **NOTICE:** To avoid electrostatic discharge, ground yourself by using a wrist grounding strap or by periodically touching an unpainted metal surface (such as the back panel) on the computer.

 **NOTICE:** To avoid damaging the system board, you must remove the main battery before you begin working inside the computer.

If you ordered a Bluetooth card with your computer, the card is already installed.

1. Follow the instructions in "[Preparing to Work Inside the Computer](#)."
2. Remove the battery.
3. Open the Bluetooth card door.
4. Using a plastic scribe or screwdriver, gently pry the Bluetooth card from the plastic guide bracket and the compartment so that you can disconnect the Bluetooth card from its cable and remove it from the computer.

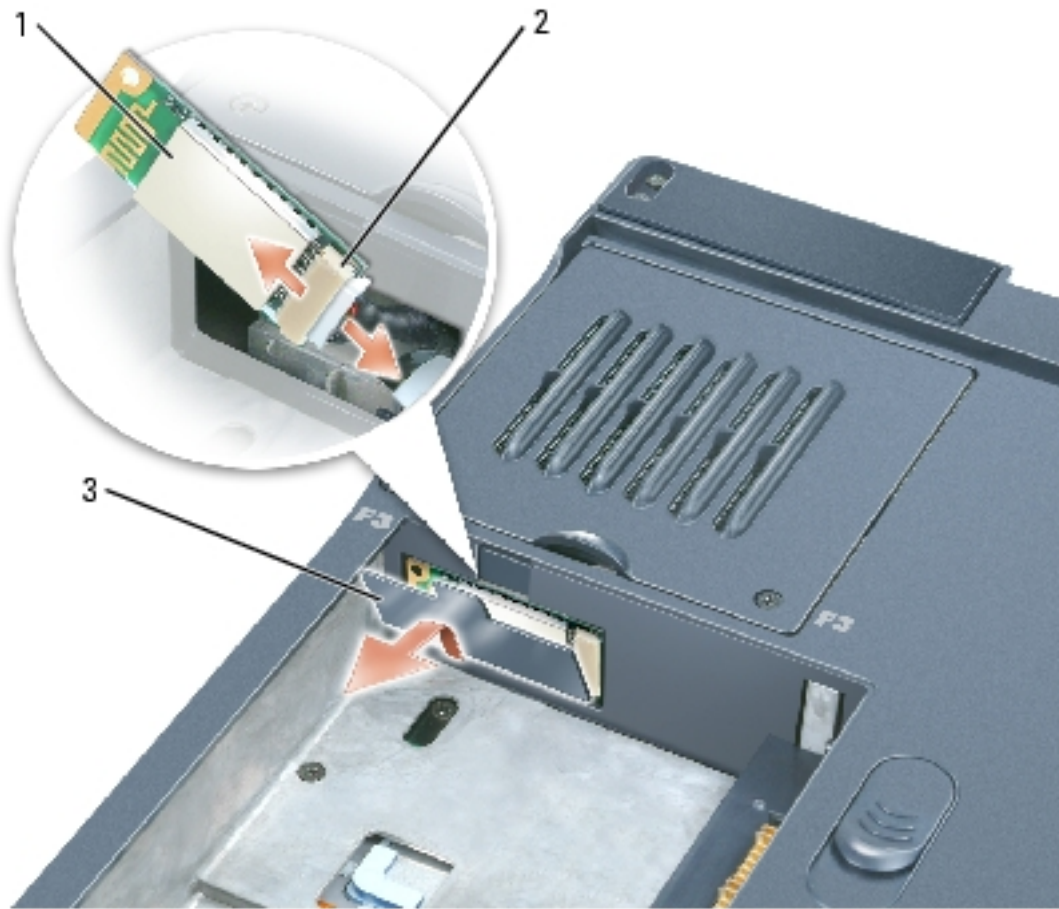

1	Bluetooth card
2	Bluetooth card connector
3	Bluetooth card door

[Back to Contents Page](#)

[Back to Contents Page](#)

Hard Drive

Dell™ Inspiron™ XPS and Inspiron 9100 Service Manual

 **CAUTION:** If you remove the hard drive from the computer when the drive is hot, do not touch the metal housing of the hard drive.

 **CAUTION:** Before working inside your computer, read the safety instructions in your *Owner's Manual*.

 **NOTICE:** To avoid damaging the system board, you must remove the main battery before you begin working inside the computer.

 **NOTICE:** To prevent data loss, turn off your computer before removing the hard drive. Do not remove the hard drive while the computer is on, in standby mode, or in hibernate mode.

 **NOTICE:** Hard drives are extremely fragile; even a slight bump can damage the drive.

 **NOTE:** Dell does not guarantee compatibility or provide support for hard drives from sources other than Dell.

 **NOTE:** You need the *Operating System* CD to install the Microsoft® Windows® operating system. You also need the *Drivers and Utilities* CD for your computer to install the drivers and utilities on the new hard drive.

1. Follow the instructions in "[Preparing to Work Inside the Computer](#)."
2. Turn over the computer and remove the M3 x 3-mm screw.

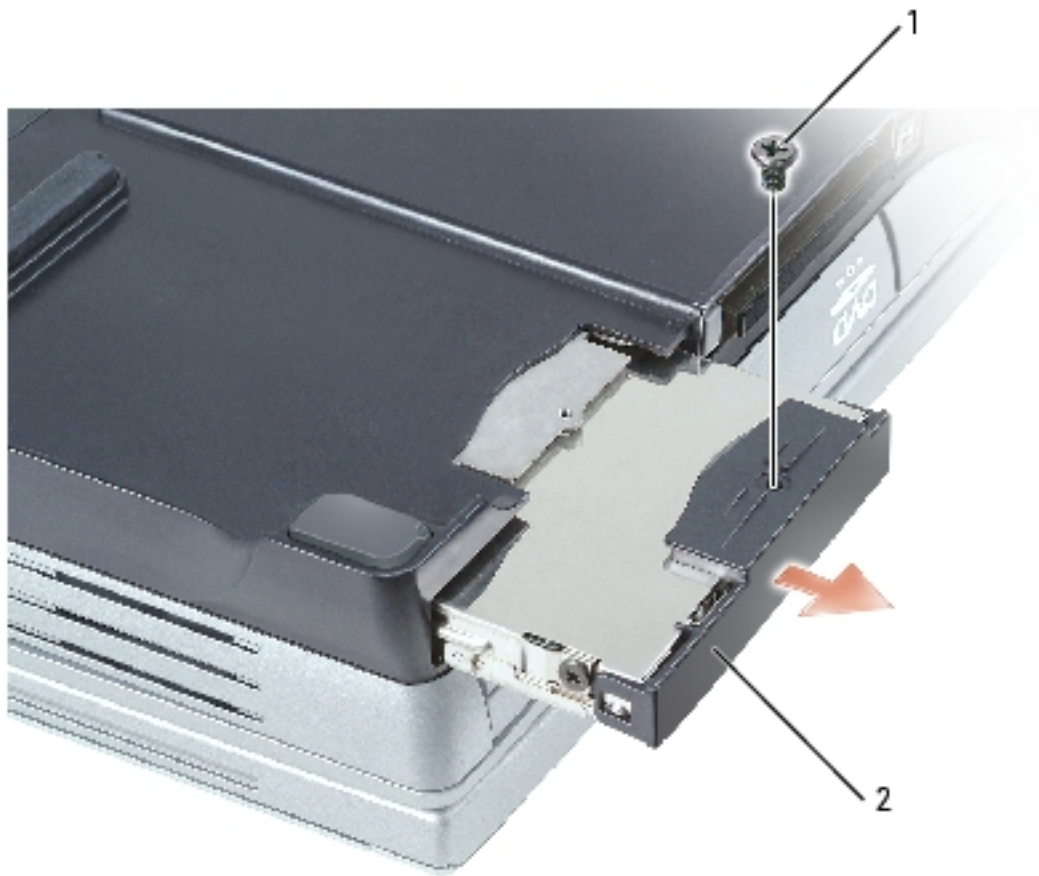

1	M3 x 3-mm screw
2	hard drive

➔ **NOTICE:** When the hard drive is not in the computer, store it in protective antistatic packaging. See "Protecting Against Electrostatic Discharge" in your *Owner's Manual*.

3. Slide the hard drive out of the computer.

4. Remove the new drive from its packaging.

Save the original packaging for storing or shipping the hard drive.

➔ **NOTICE:** Use firm and even pressure to slide the drive into place. If you use excessive force, you may damage the connector.

5. Slide the drive into the bay until it is fully seated.

6. Replace and tighten the screw.
7. Use the *Operating System CD* to install the operating system for your computer. For instructions, see "Reinstalling Microsoft Windows XP" in your *Owner's Manual*.
8. Use the *Drivers and Utilities CD* to install the drivers and utilities for your computer. For instructions, see "Reinstalling Drivers and Utilities" in your *Owner's Manual*.

Returning a Hard Drive to Dell

Return your old hard drive to Dell in its original or comparable foam packaging. Otherwise, the hard drive may be damaged in transit.

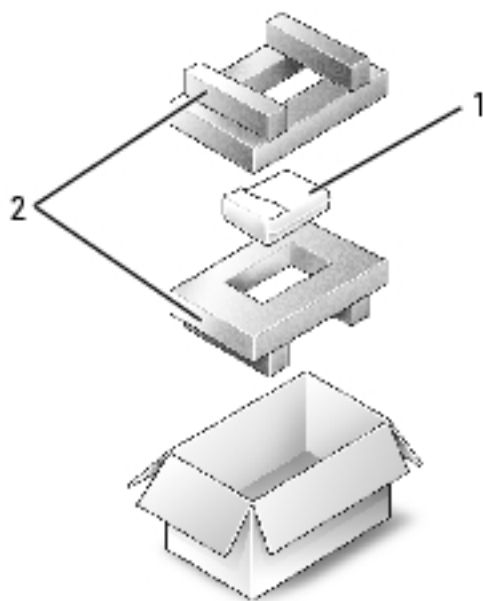

1	hard drive
2	foam packaging

[Back to Contents Page](#)

[Back to Contents Page](#)

Fans

Dell™ Inspiron™ XPS and Inspiron 9100 Service Manual

 **CAUTION:** Before performing the following procedures, read the safety instructions in your *Owner's Manual*.

 **NOTICE:** To avoid electrostatic discharge, ground yourself by using a wrist grounding strap or by periodically touching an unpainted metal surface (such as the back panel) on the computer.

 **NOTICE:** To avoid damaging the system board, you must remove the main battery before you begin working inside the computer.

The two fans are located on the bottom of the computer, one with screws labeled "F2" (fan 2) and one with screws labeled "F3" (fan 3).

To remove fan 2:

1. Follow the instructions in "[Preparing to Work Inside the Computer](#)."
2. Turn over the computer.
3. Unscrew the two captive screws labeled "F2," lift up the fan cover, and remove it from the computer.

 **NOTE:** This fan cover comes off over the audio connectors.

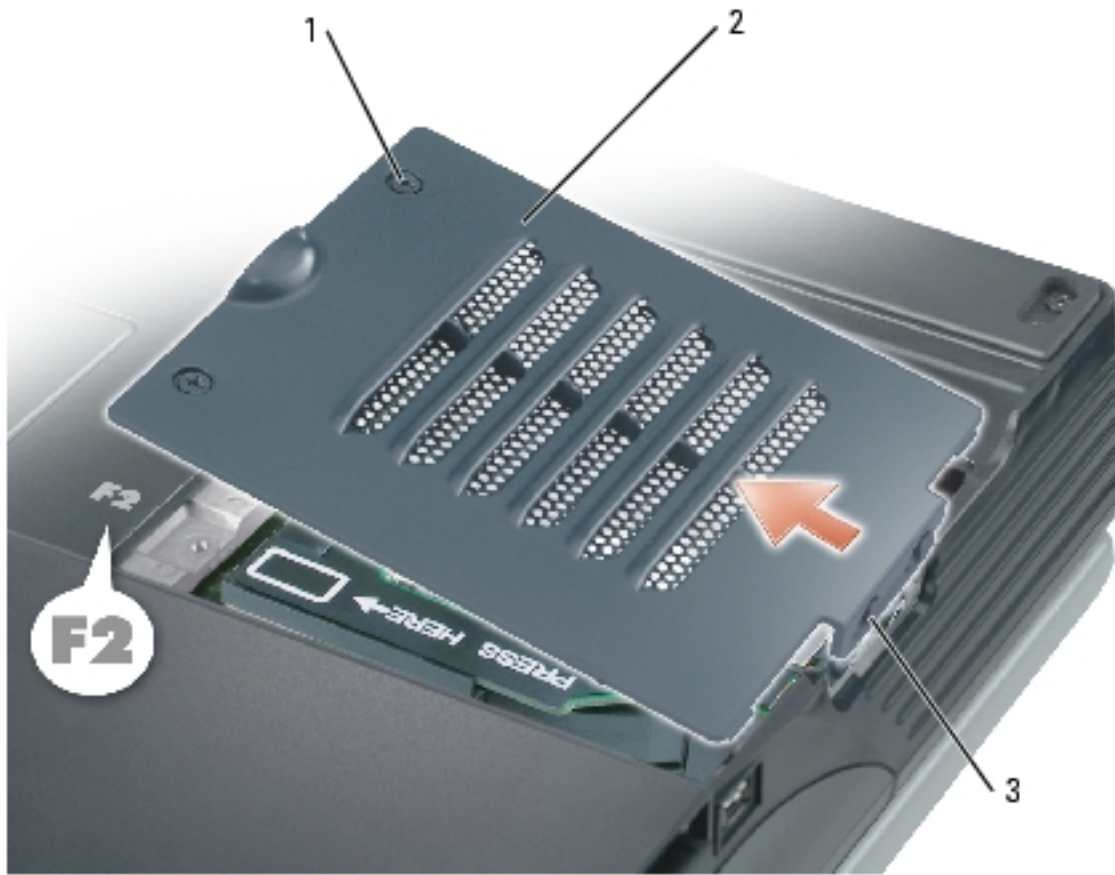

1	captive screws (2)
2	fan cover
3	audio connectors

4. Remove the M2.5 x 6-mm screw on the fan and lift up the fan release lever.

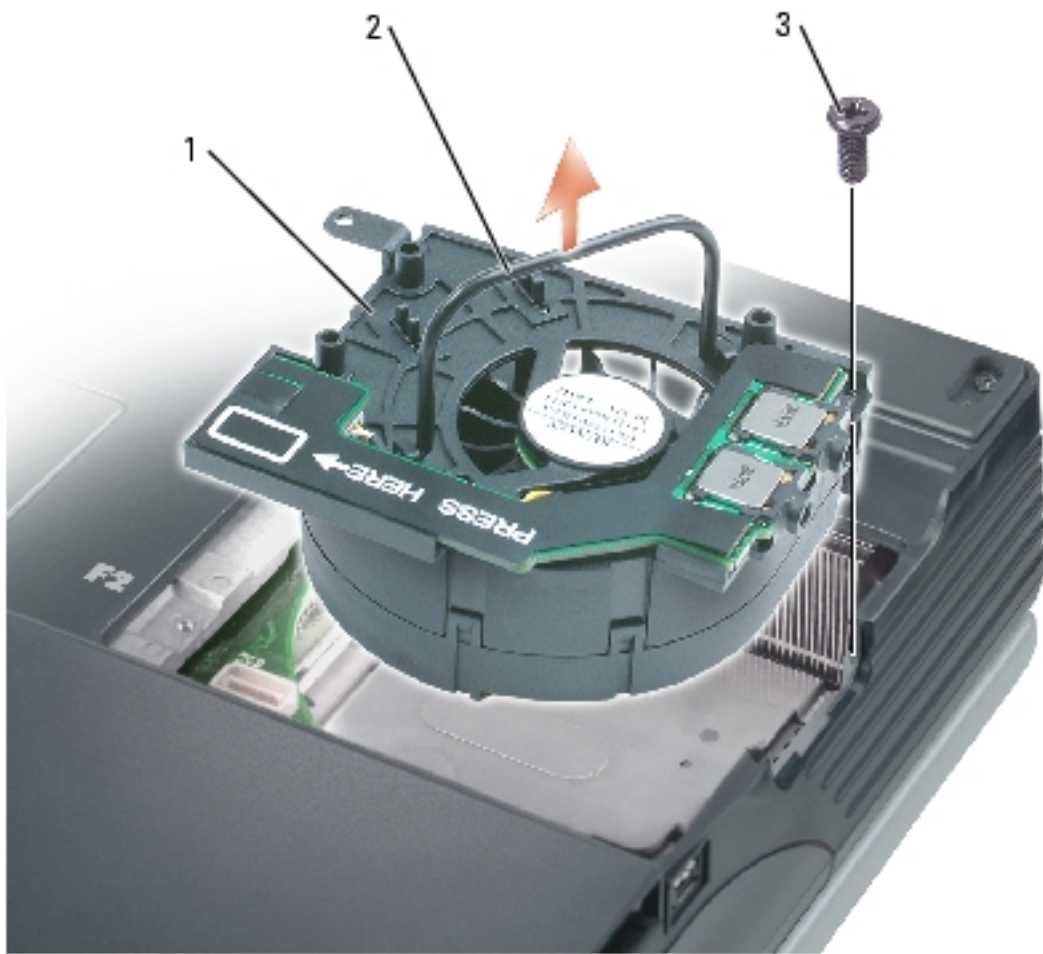

1	fan
2	fan release lever
3	M2.5 x 6-mm screw

5. Use the fan release lever to lift the fan out of the computer.

When replacing fan 2, press down on the fan surface labeled "Press here" to securely seat the fan in place.

To remove fan 3:

1. Unscrew the two captive screws labeled "F3."
2. Lift the fan out of the computer.



NOTE: The cover on this fan is not removable. It remains attached to the fan.

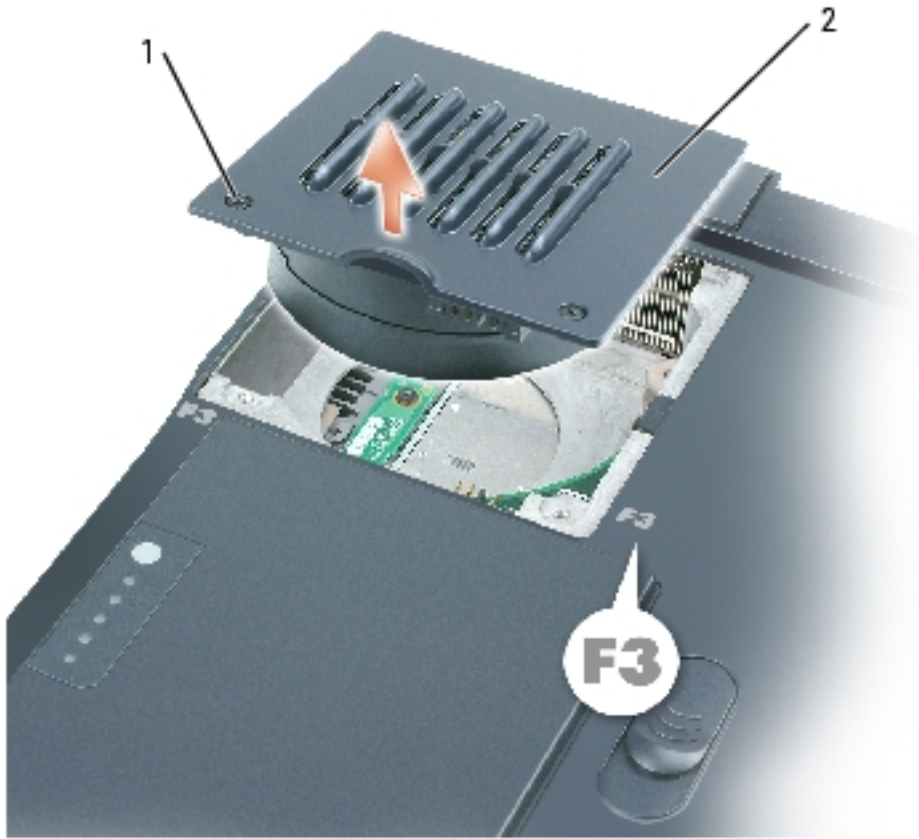

1	captive screws (2)
2	fan cover

[Back to Contents Page](#)

[Back to Contents Page](#)

Hinge Covers

Dell™ Inspiron™ XPS and Inspiron 9100 Service Manual

 **CAUTION:** Before working inside your computer, read the safety instructions in your *Owner's Manual*.

 **NOTICE:** To avoid electrostatic discharge, ground yourself by using a wrist grounding strap or by periodically touching an unpainted metal surface (such as the back panel) on the computer.

 **NOTICE:** To avoid damaging the system board, you must remove the main battery before you begin working inside the computer.

1. Follow the instructions in "[Preparing to Work Inside the Computer](#)."

 **NOTE:** The hinge cover consists of three separate pieces: the left cover, the right cover, and the center cover. To remove computer components, you must remove all three covers *except* for when removing the keyboard or the reserve battery. For these two components, remove only the center cover.

2. Remove the left and right hinge covers:
 - a. Open the display.
 - b. Slide the left and right hinge covers forward (toward the back of the computer) and then slide them to the side, away from the computer.

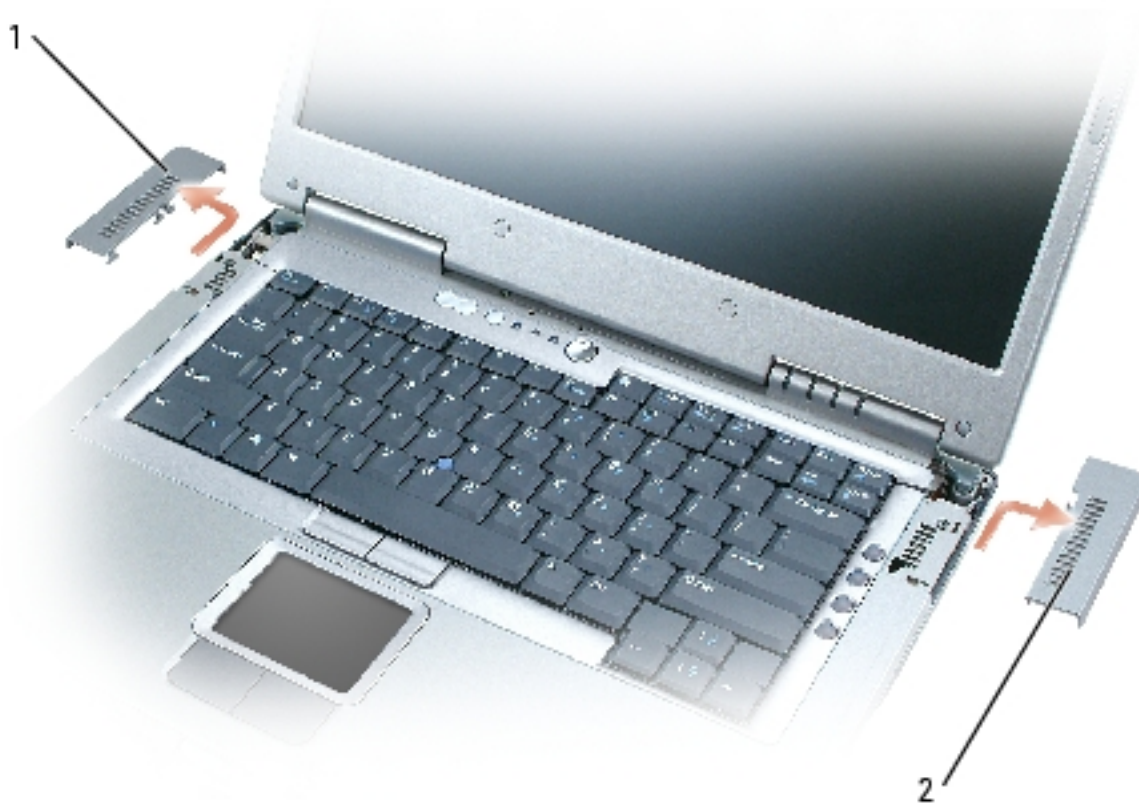

1	left hinge cover
2	right hinge cover

3. Remove the center hinge cover:

- a. Close the display.
- b. Facing the front of the computer, press in on the two hinge cover snaps and pull them up slightly to disengage them.



1 hinge cover snaps (2)

- c. Open the display all the way (180 degrees) so that it lies flat against your work surface.
- d. Lift the center hinge cover just enough to access the flex-cable connector.
- e. Using the pull-tab, disconnect the center-hinge-cover flex cable from the system board connector.

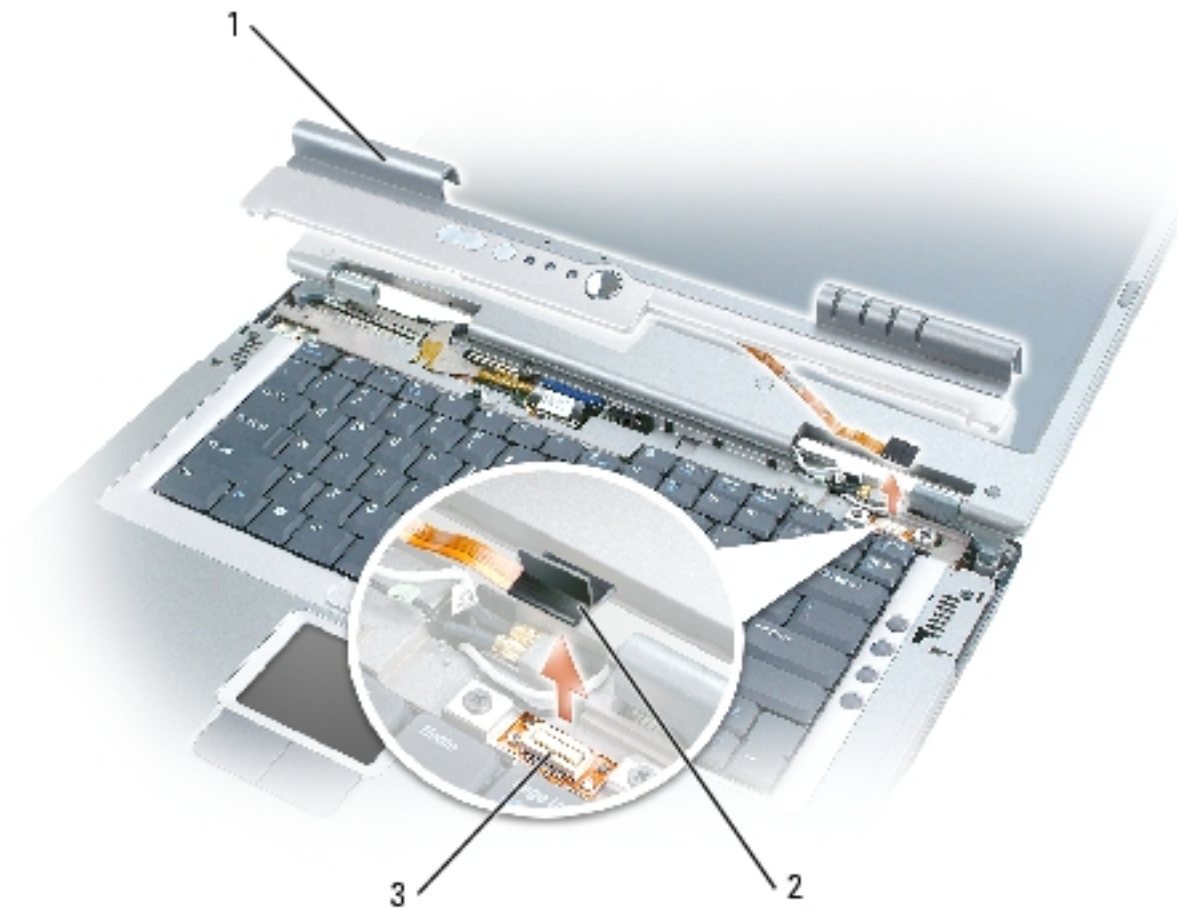

1	center hinge cover
2	center-hinge-cover flex cable and pull-tab
3	system board connector

[Back to Contents Page](#)

[Back to Contents Page](#)

Keyboard

Dell™ Inspiron™ XPS and Inspiron 9100 Service Manual

 **CAUTION:** Before performing the following procedures, read the safety instructions in your *Owner's Manual*.

 **NOTICE:** To avoid electrostatic discharge, ground yourself by using a wrist grounding strap or by periodically touching an unpainted metal surface (such as the back panel) on the computer.

 **NOTICE:** To avoid damaging the system board, you must remove the main battery before you begin working inside the computer.

1. Follow the instructions in "[Preparing to Work Inside the Computer](#)."
2. Open the display.
3. Remove the center [hinge cover](#).

 **NOTE:** You do not need to remove the left and right hinge covers.

4. Remove the keyboard:
 - a. Remove the two M2.5 x 3-mm screws across the top of the keyboard.

 **NOTICE:** The keycaps on the keyboard are fragile, easily dislodged, and time-consuming to replace. Be careful when removing and handling the keyboard.

- b. Lift up the keyboard and gently slide it toward the display.
- c. Hold the keyboard up and slightly forward to allow access to the keyboard connector.
- d. Pull up on the keyboard connector tab to disconnect the keyboard connector from the system board.



1	keyboard
2	M2.5 x 3-mm screws (2)
3	keyboard connector tab
4	system board connector

NOTICE: To avoid scratching the palm rest when replacing the keyboard, hook the four tabs along the front edge of the keyboard into the palm rest, and then secure the keyboard in place.

[Back to Contents Page](#)

[Back to Contents Page](#)

Modem

Dell™ Inspiron™ XPS and Inspiron 9100 Service Manual

 **CAUTION:** Before performing the following procedures, read the safety instructions in your *Owner's Manual*.

 **NOTICE:** To avoid electrostatic discharge, ground yourself by using a wrist grounding strap or by periodically touching an unpainted metal surface (such as the back panel) on the computer.

 **NOTICE:** To avoid damaging the system board, you must remove the main battery before you begin working inside the computer.

Removing the Modem

1. Follow the instructions in "[Preparing to Work Inside the Computer](#)."
2. Remove the left, right, and center [hinge covers](#).
3. Remove the [keyboard](#).
4. Remove the M2.5 x 3-mm screw.

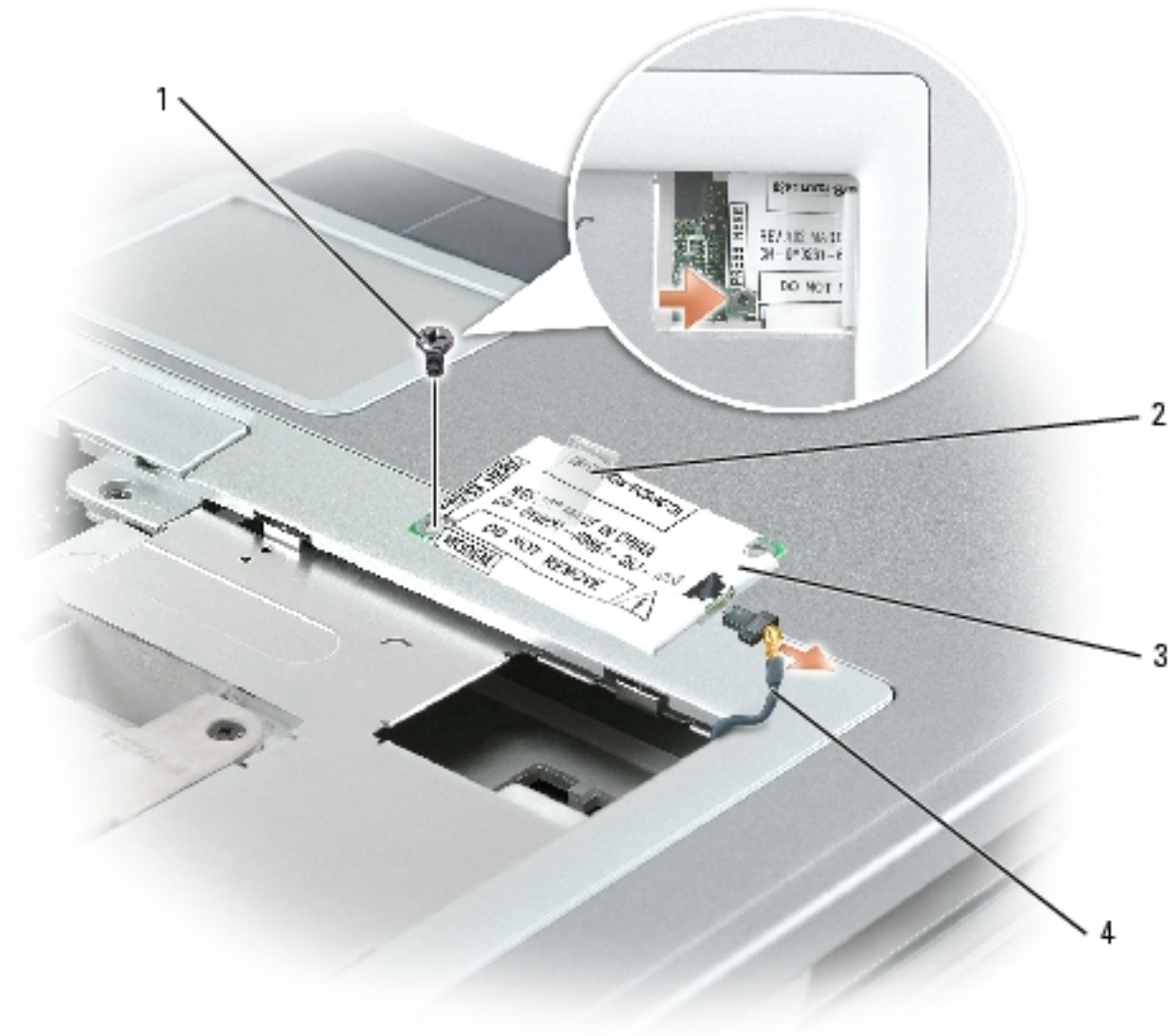

1	M2.5 x 3-mm screw
2	pull-tab
3	modem
4	modem cable

5. Pull up on the pull-tab to disconnect the modem from the modem connector on the system board.

NOTICE: Do not disconnect the modem cable from the system board.

6. Disconnect the modem cable from the modem.

Installing the Modem

1. Connect the modem cable to the modem.

 **NOTICE:** Ensure that the modem cable is routed correctly when you replace the modem.

 **NOTICE:** Do not press down on the left side of the modem while installing it.

2. Align the connector on the bottom of the modem with the modem connector on the system board and then press down on the right side of the modem to seat both connectors.
3. Replace the M2.5 x 3-mm screw.

[Back to Contents Page](#)

[Back to Contents Page](#)

Reserve Battery

Dell™ Inspiron™ XPS and Inspiron 9100 Service Manual

 **CAUTION:** Before performing the following procedures, read the safety instructions in your *Owner's Manual*.

 **NOTICE:** To avoid electrostatic discharge, ground yourself by using a wrist grounding strap or by periodically touching an unpainted metal surface (such as the back panel) on the computer.

 **NOTICE:** To avoid damaging the system board, you must remove the main battery before you begin working inside the computer.

1. Follow the instructions in "[Preparing to Work Inside the Computer](#)."
2. Remove the center [hinge cover](#).

 **NOTE:** You do not need to remove the left and right hinge covers.

3. Remove the [keyboard](#).
4. Disconnect the reserve battery cable connector from the system board.
5. Lift the reserve battery clip slightly to disengage it from the fan chassis.
6. Pull the reserve battery together with the clip straight out of the computer base.

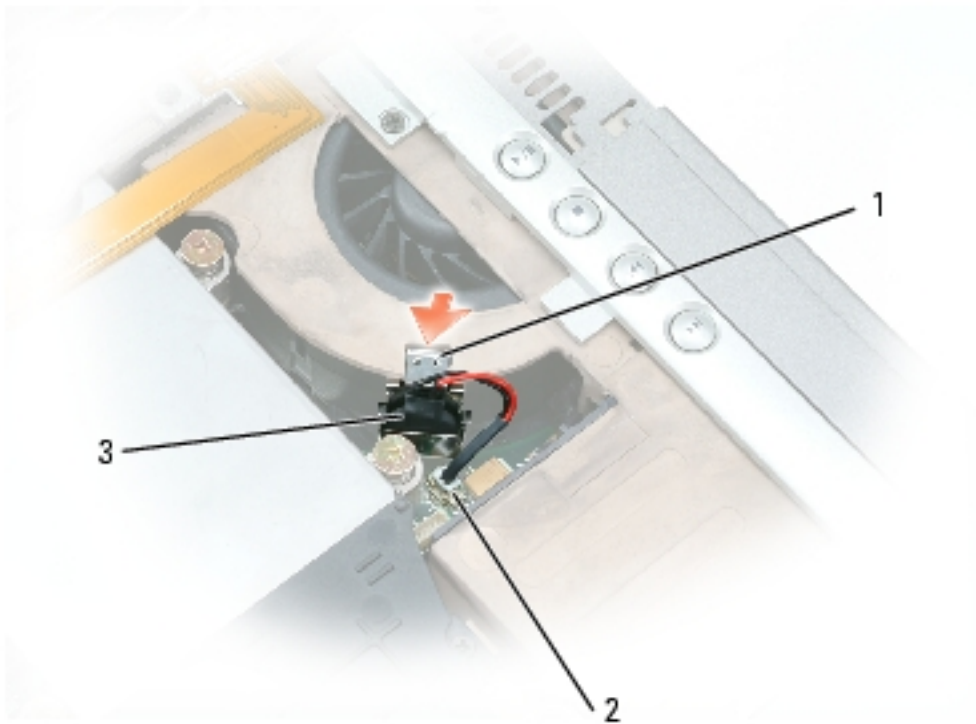

1	reserve battery clip
2	system board connector
3	reserve battery



NOTE: Use a scribe to press the reserve battery cable connector into the system board connector when replacing the reserve battery.

[Back to Contents Page](#)

[Back to Contents Page](#)

Display Assembly and Display Latch

Dell™ Inspiron™ XPS and Inspiron 9100 Service Manual

- [Display Bezel](#)
- [Display Panel](#)
- [Display Latch](#)

 **CAUTION:** Before performing the following procedures, read the safety instructions in your *Owner's Manual*.

- ➡ **NOTICE:** To avoid electrostatic discharge, ground yourself by using a wrist grounding strap or by periodically touching an unpainted metal surface (such as the back panel) on the computer.
- ➡ **NOTICE:** To avoid damaging the system board, you must remove the main battery before you begin working inside the computer.

1. Follow the instructions in "[Preparing to Work Inside the Computer](#)."

- ➡ **NOTICE:** Before turning the computer over and removing the screws, ensure that the display is firmly latched closed.
2. Turn the computer over and remove the four screws (two on each side) labeled "D" on the bottom of the computer.

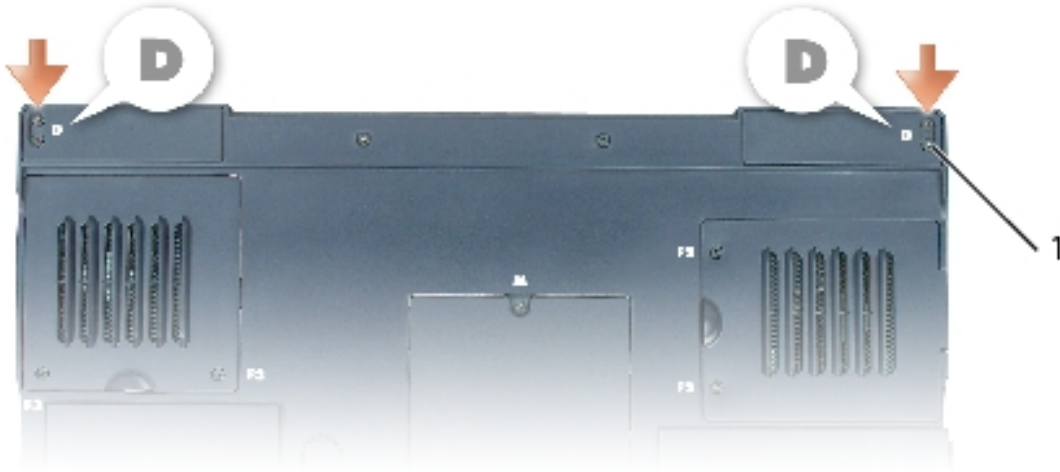

1	M2.5 x 6-mm screws labeled "D" (4)
---	------------------------------------

3. Turn the computer over and open the display.
4. Remove the left, right, and center [hinge covers](#).
5. Disconnect the antenna cables (pull to separate the connectors).

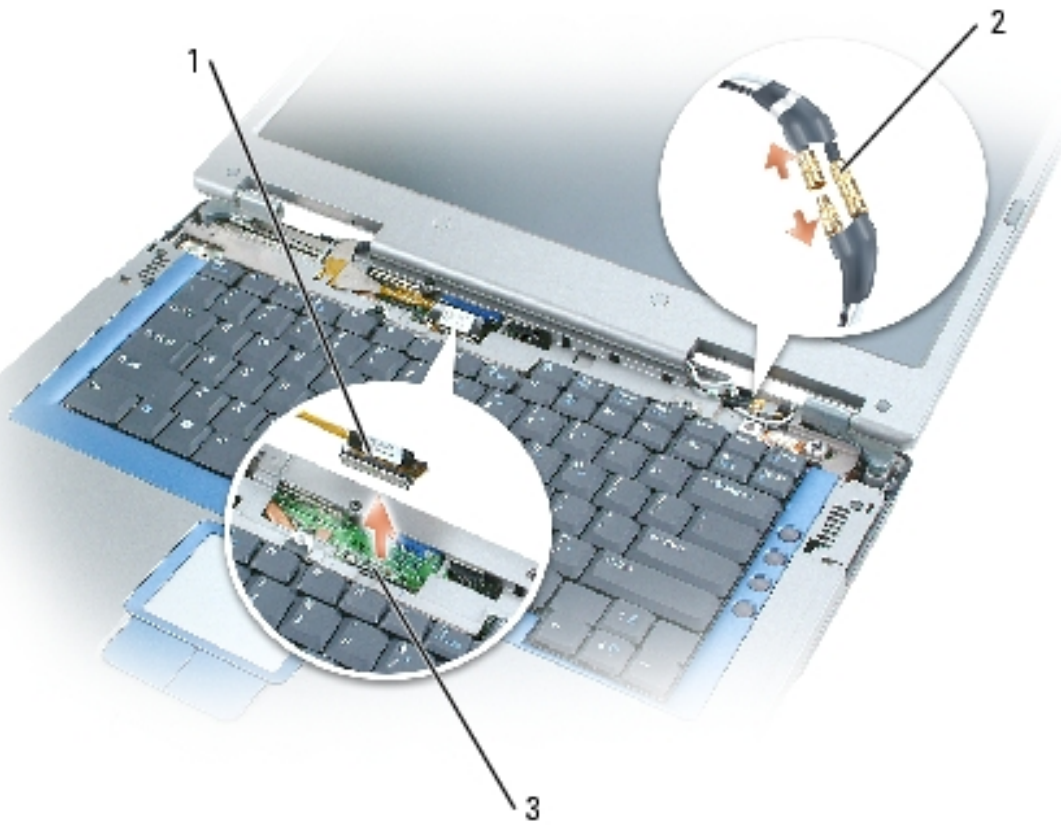

1	display cable
2	antenna cables (2)
3	system board connector

- 6. Use the pull-tab to disconnect the display cable.
- 7. Lift the display out of the computer at a 90-degree angle.

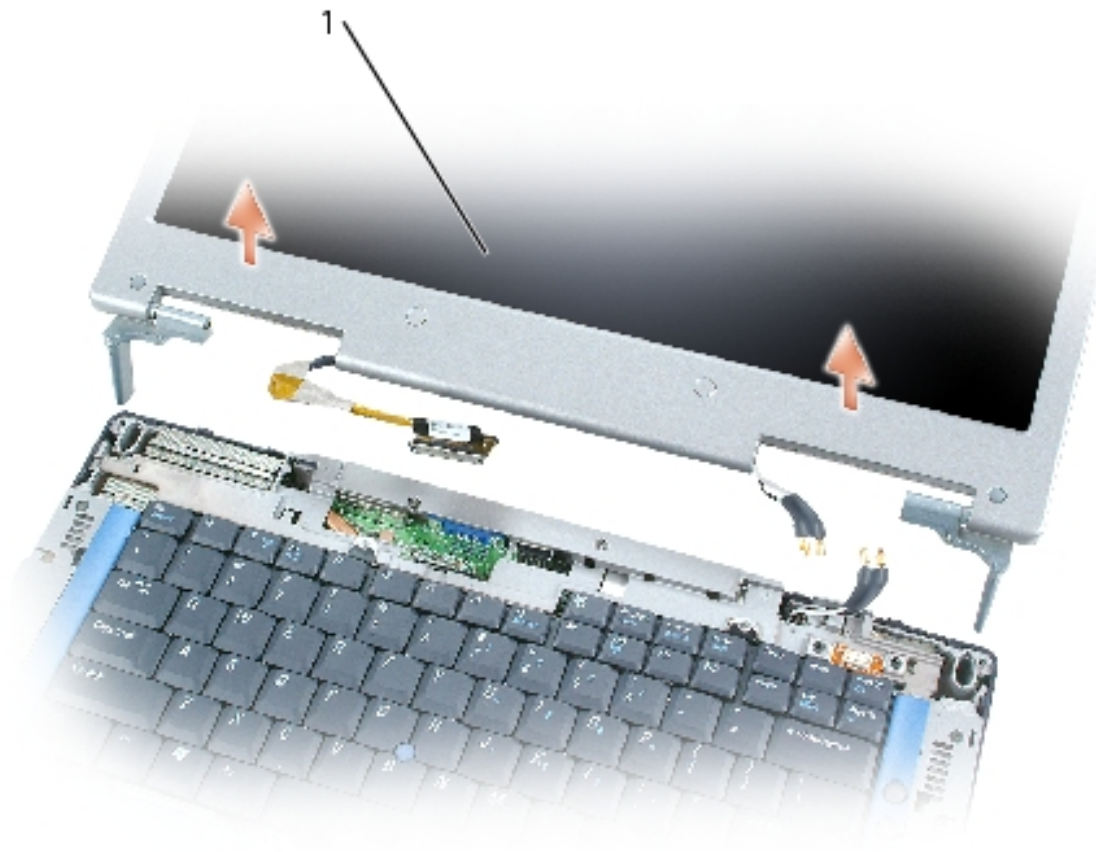

1	display
---	---------

Display

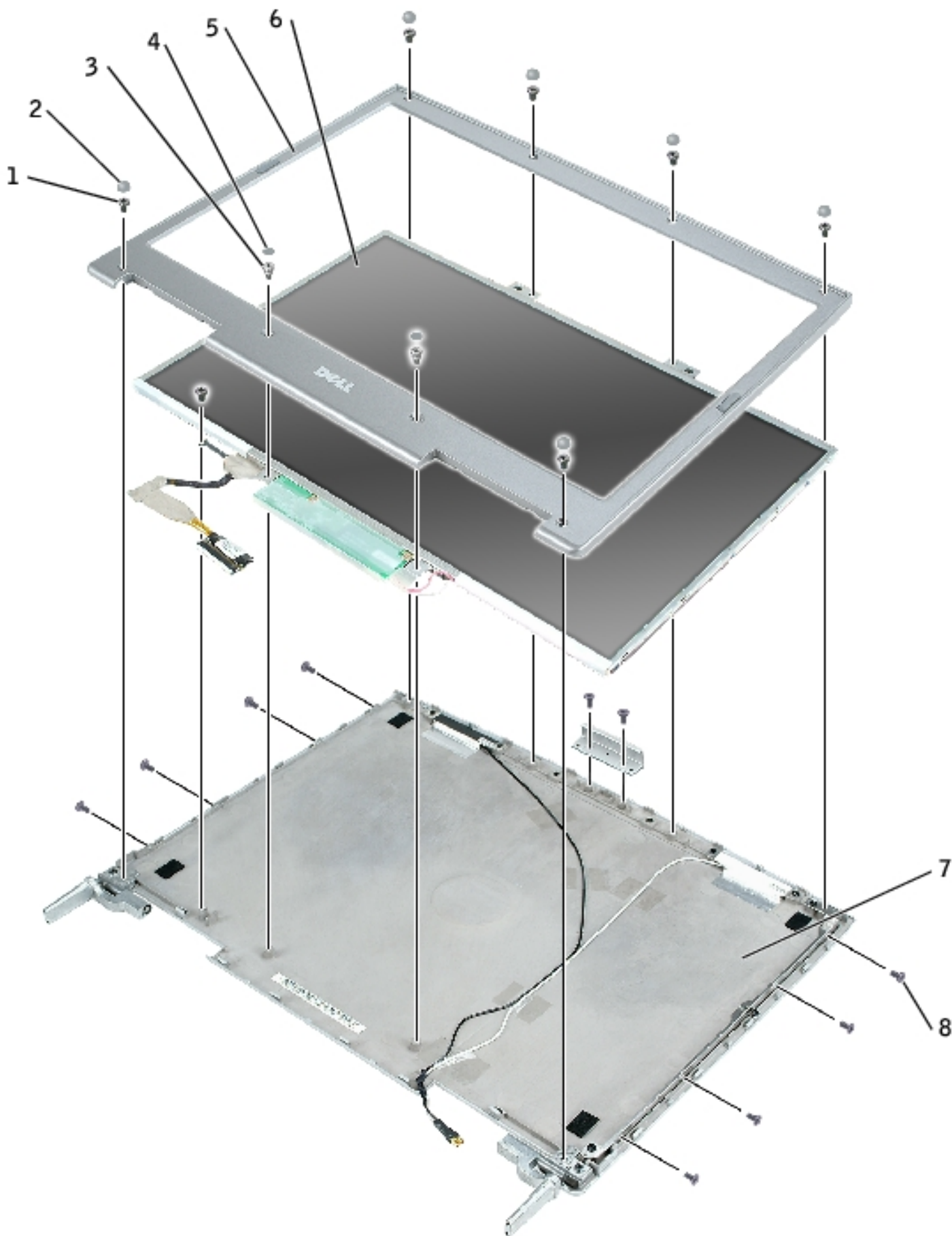

1	M2.5 x 6-mm screws (6)	5	display bezel
2	rubber display bumpers (6)	6	display panel
3	M2.5 x 6-mm shoulder screws (2)	7	display base
4	screw covers (2)	8	M2.5 x 3-mm screws (8)

Display Bezel

 **CAUTION:** Before performing the following procedures, read the safety instructions in your *Owner's Manual*.

 **NOTICE:** To avoid electrostatic discharge, ground yourself by using a wrist grounding strap or by periodically touching an unpainted metal surface (such as the back panel) on the computer.

 **NOTICE:** To avoid damaging the system board, you must remove the main battery before you begin working inside the computer.

1. Follow the instructions in "[Preparing to Work Inside the Computer](#)."
2. Remove the [display](#).
3. Remove the six rubber display bumpers and two screw covers.
4. Remove the six M2.5 x 6-mm screws and two M2.5 x 6-mm shoulder screws and remove the display bezel.

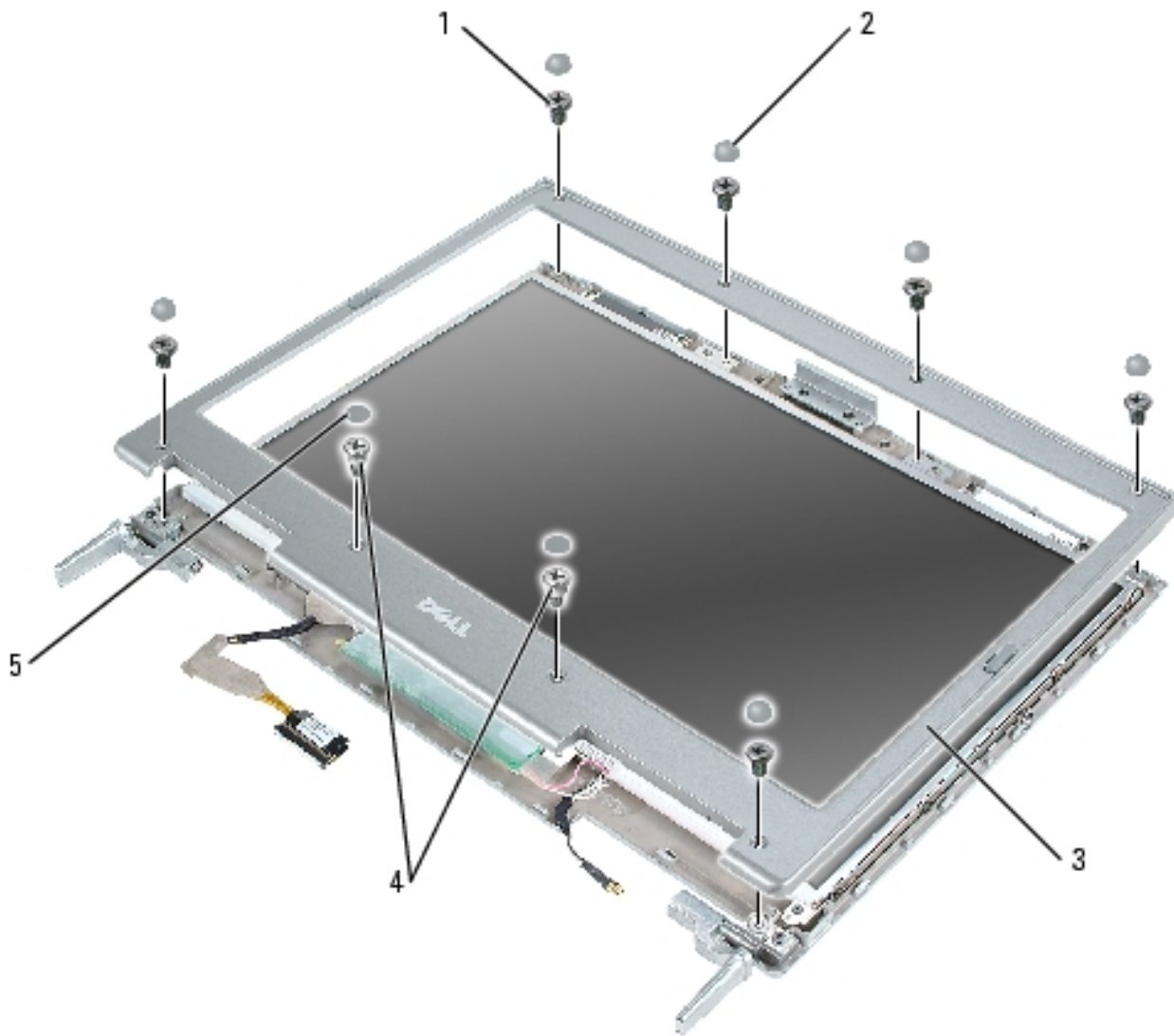

1	M2.5 x 6-mm screws (6)
2	rubber display bumpers (6)
3	display bezel
4	M2.5 x 6-mm shoulder screws (2)
5	screw covers (2)

Display Panel

⚠ CAUTION: Before performing the following procedures, read the safety instructions in your *Owner's Manual*.

- ➡ **NOTICE:** To avoid electrostatic discharge, ground yourself by using a wrist grounding strap or by touching an unpainted metal surface on the computer.
- ➡ **NOTICE:** To avoid damaging the system board, you must remove the main battery before you begin working inside the computer.

1. Follow the instructions in "[Preparing to Work Inside the Computer.](#)"
2. Remove the [display](#).
3. Remove the [display bezel](#).
4. Remove the M2 x 3-mm ground screw that attaches the display-panel ground wire to the back display cover.
5. Remove the eight M2 x 3-mm screws from each side of the display panel.
6. Lift the display panel out of the display cover.

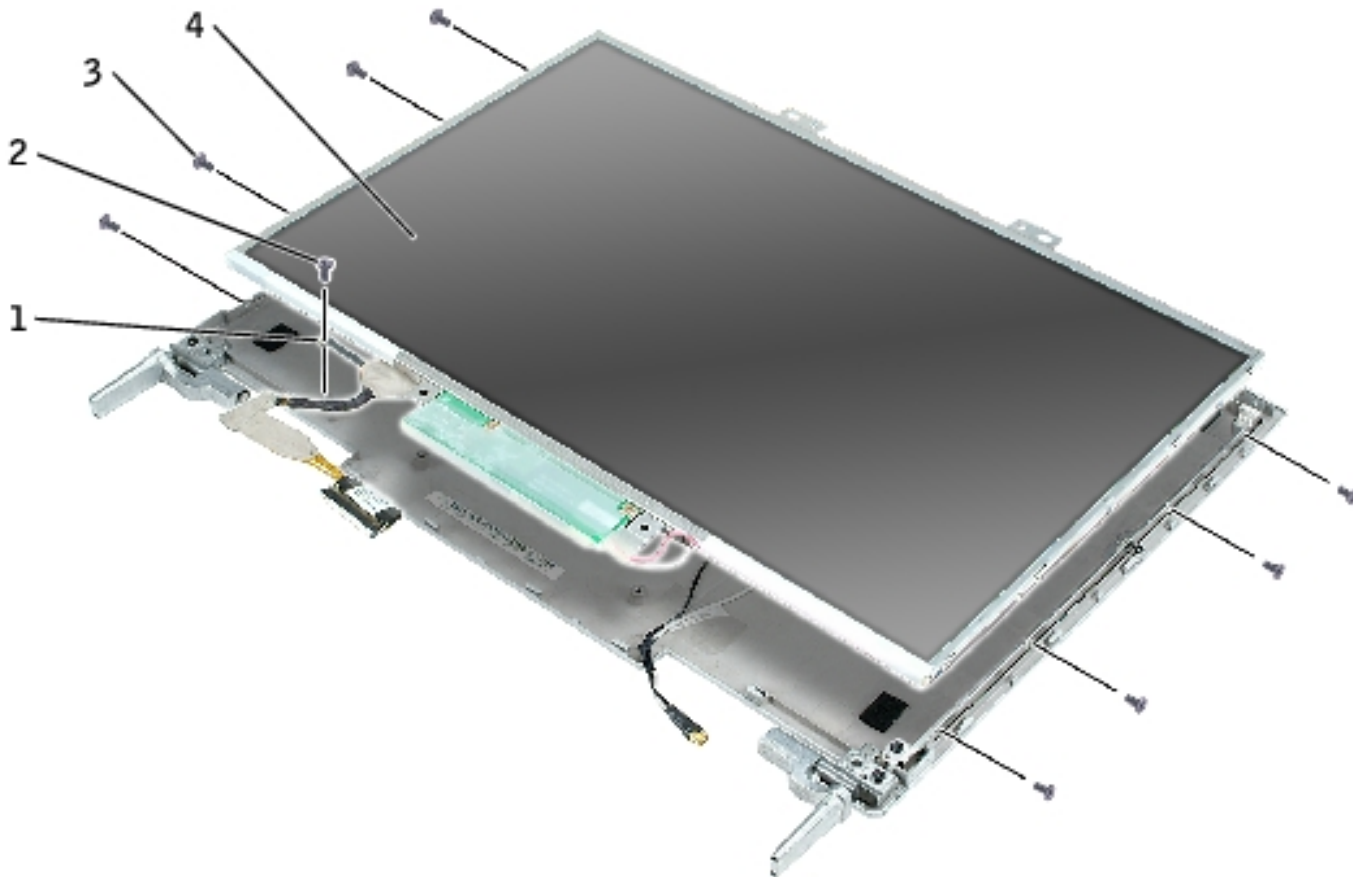

1	display-panel ground wire
---	---------------------------

2	M2 x 3-mm ground screw
3	M2 x 3-mm screws (8)
4	display panel

7. Press in both sides of the top flex-cable connector, and pull the top flex-cable connector away from the display connector.
8. Use the pull-tab to disconnect the bottom flex-cable connector from the inverter connector.

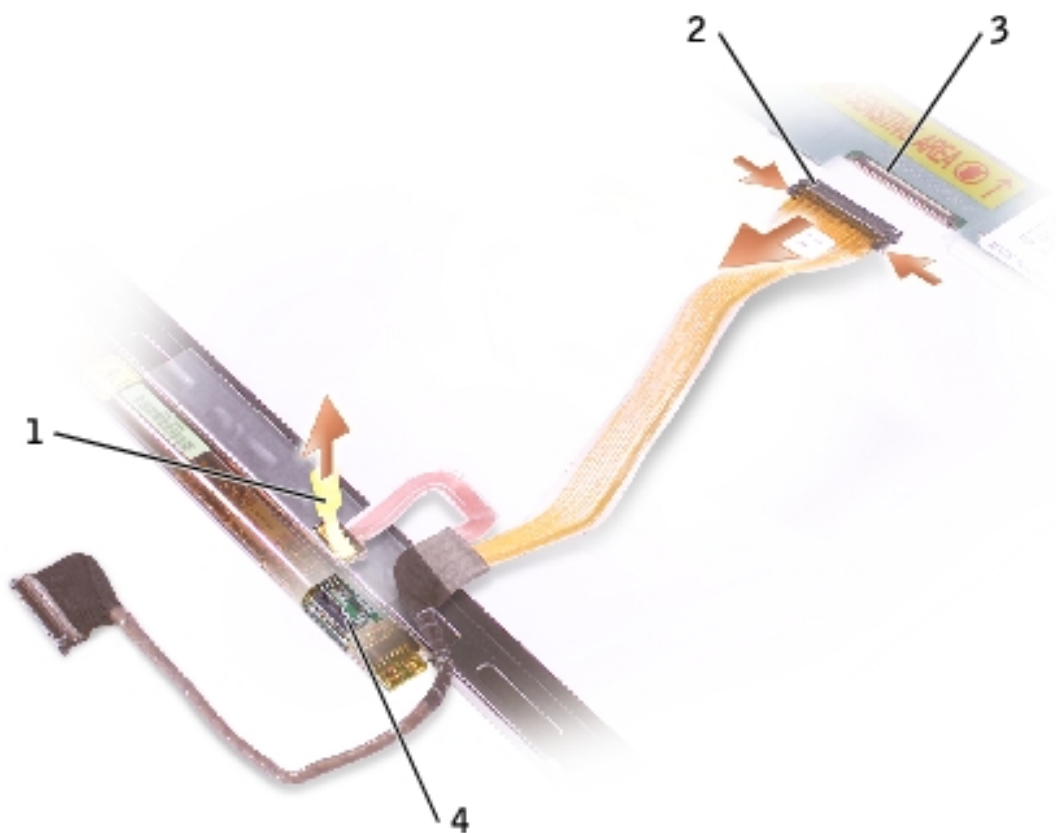

1	pull-tab on bottom flex-cable connector
2	top flex-cable connector
3	display connector
4	inverter connector

Display Latch

 **CAUTION:** Before performing the following procedures, read the safety instructions in your *Owner's Manual*.

 **NOTICE:** To avoid electrostatic discharge, ground yourself by using a wrist grounding strap or by touching an unpainted metal surface on the computer.

 **NOTICE:** To avoid damaging the system board, you must remove the main battery before you begin working inside the computer.

1. Follow the instructions in "[Preparing to Work Inside the Computer](#)."
2. Remove the [display](#).
3. Remove the [display bezel](#).
4. Remove the two M2.5 x 4-mm screws and remove the display latch.

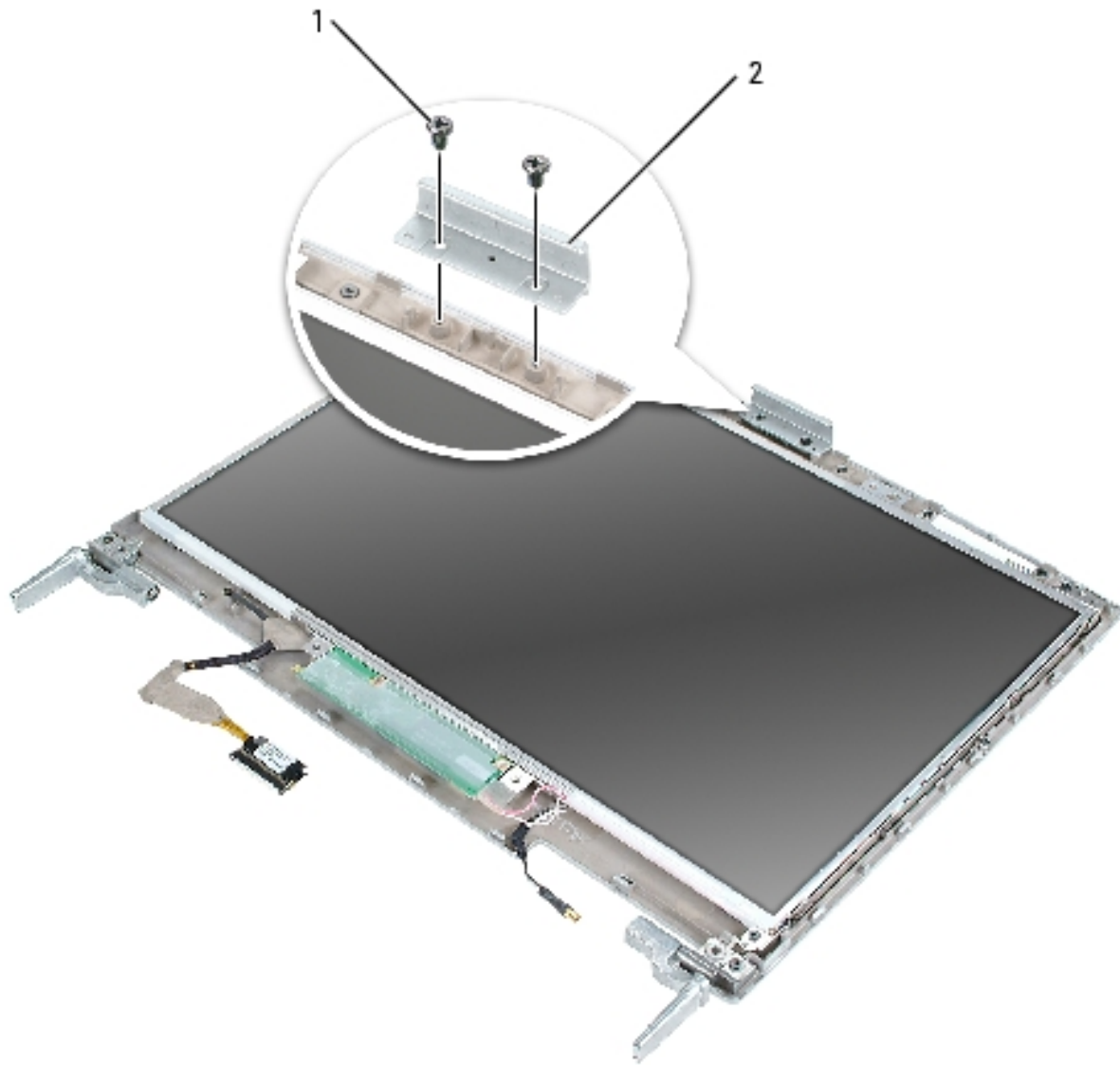

1	M2.5 x 4-mm screws (2)
2	display latch

[Back to Contents Page](#)

[Back to Contents Page](#)

Keyboard Bracket

Dell™ Inspiron™ XPS and Inspiron 9100 Service Manual



CAUTION: Before performing the following procedures, read the safety instructions in your *Owner's Manual*.



NOTICE: To avoid electrostatic discharge, ground yourself by using a wrist grounding strap or by periodically touching an unpainted metal surface (such as the back panel) on the computer.



NOTICE: To avoid damaging the system board, you must remove the main battery before you begin working inside the computer.

1. Follow the instructions in "[Preparing to Work Inside the Computer](#)."
2. Remove the left, right, and center [hinge covers](#).
3. Remove the [keyboard](#).
4. Remove the [display assembly](#).
5. Remove the four M2.5 x 6-mm screws.
6. Pull up on the pull-tab on the FPC cable connector to disconnect the FPC cable from the keyboard bracket
7. Slightly lift up the keyboard bracket, move it approximately one inch toward the back of the computer, and then lift straight up to remove it.

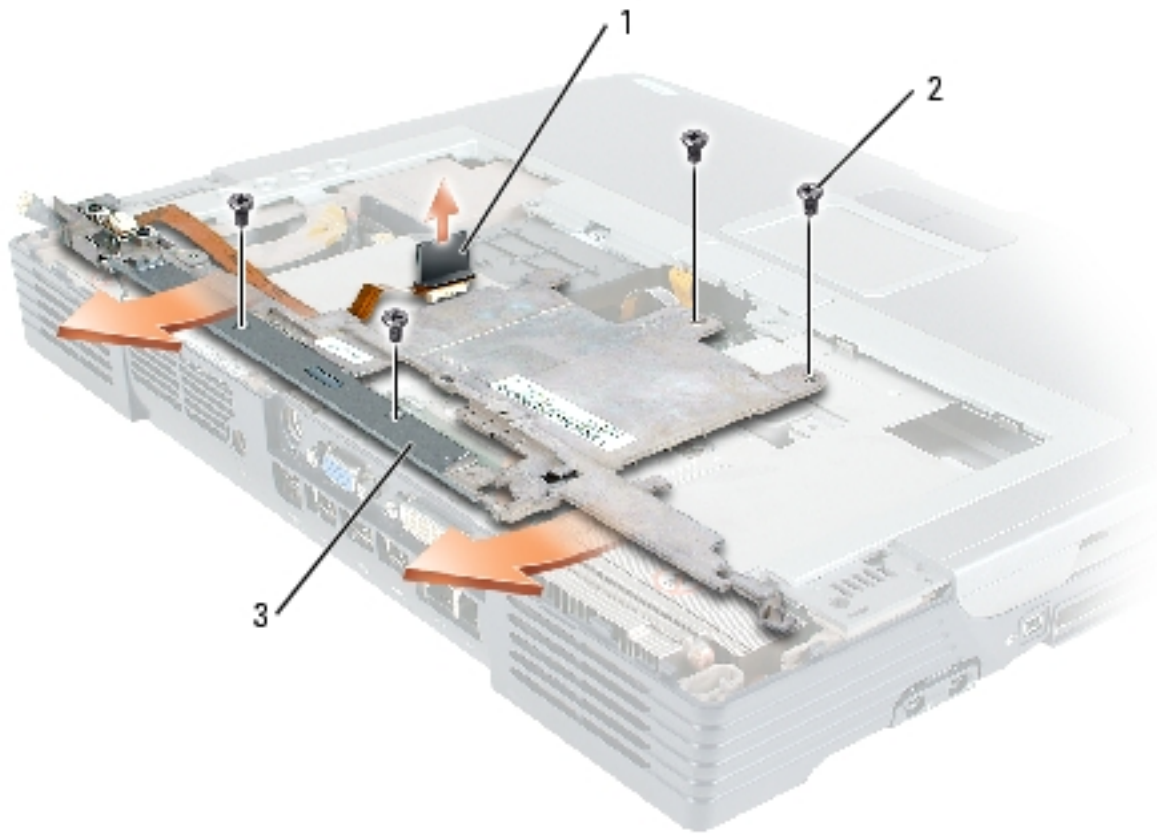

1	FPC cable pull-tab
2	M2.5 x 6-mm screws (4)
3	keyboard bracket

[Back to Contents Page](#)

[Back to Contents Page](#)

Palm Rest

Dell™ Inspiron™ XPS and Inspiron 9100 Service Manual

 **CAUTION:** Before performing the following procedures, read the safety instructions in your *Owner's Manual*.

 **NOTICE:** To avoid electrostatic discharge, ground yourself by using a wrist grounding strap or by periodically touching an unpainted metal surface (such as the back panel) on the computer.

 **NOTICE:** To avoid damaging the system board, you must remove the main battery before you begin working inside the computer.

1. Follow the instructions in "[Preparing to Work Inside the Computer](#)."
2. Remove the left, right, and center [hinge covers](#).
3. Remove the [keyboard](#).
4. Remove the [display assembly](#).
5. Remove the [keyboard bracket](#).
6. Turn over the computer and remove the three M2.5 x 8-mm screws labeled "P."

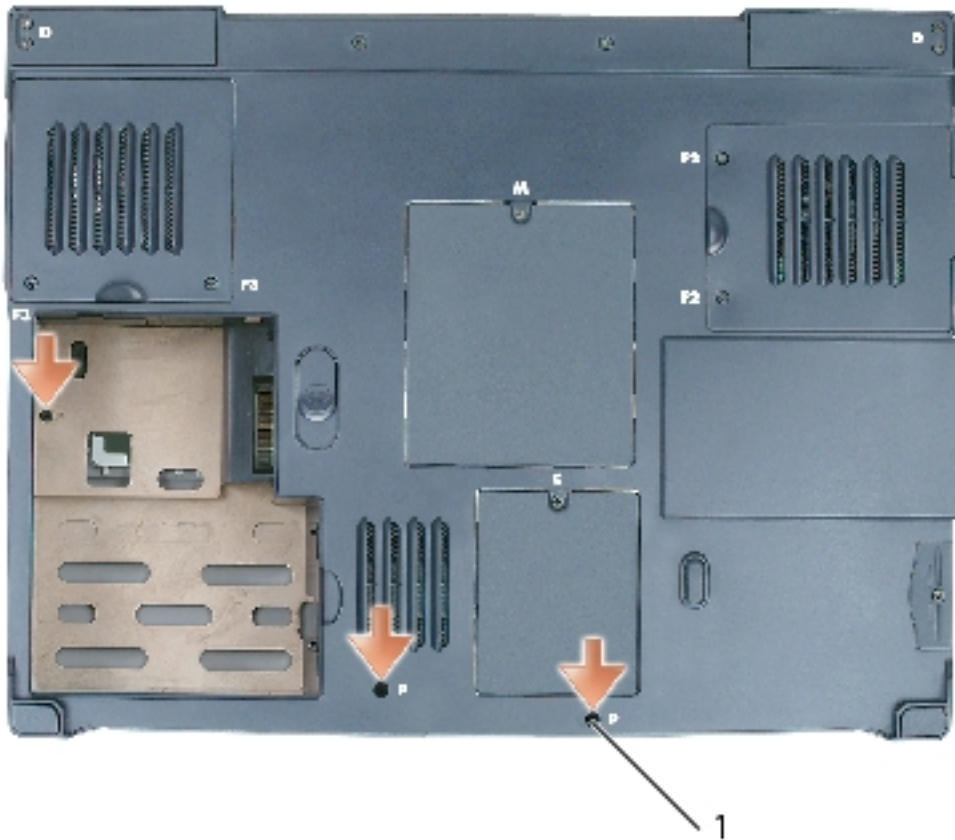

1	M2.5 x 8-mm screws labeled "P" (3)
---	------------------------------------

7. Turn the computer top-side up and remove the four M2.5 x 6-mm screws labeled "P."
8. Disconnect the touch-pad connector from the system board.
9. Slide the palm rest forward and remove it from the computer.

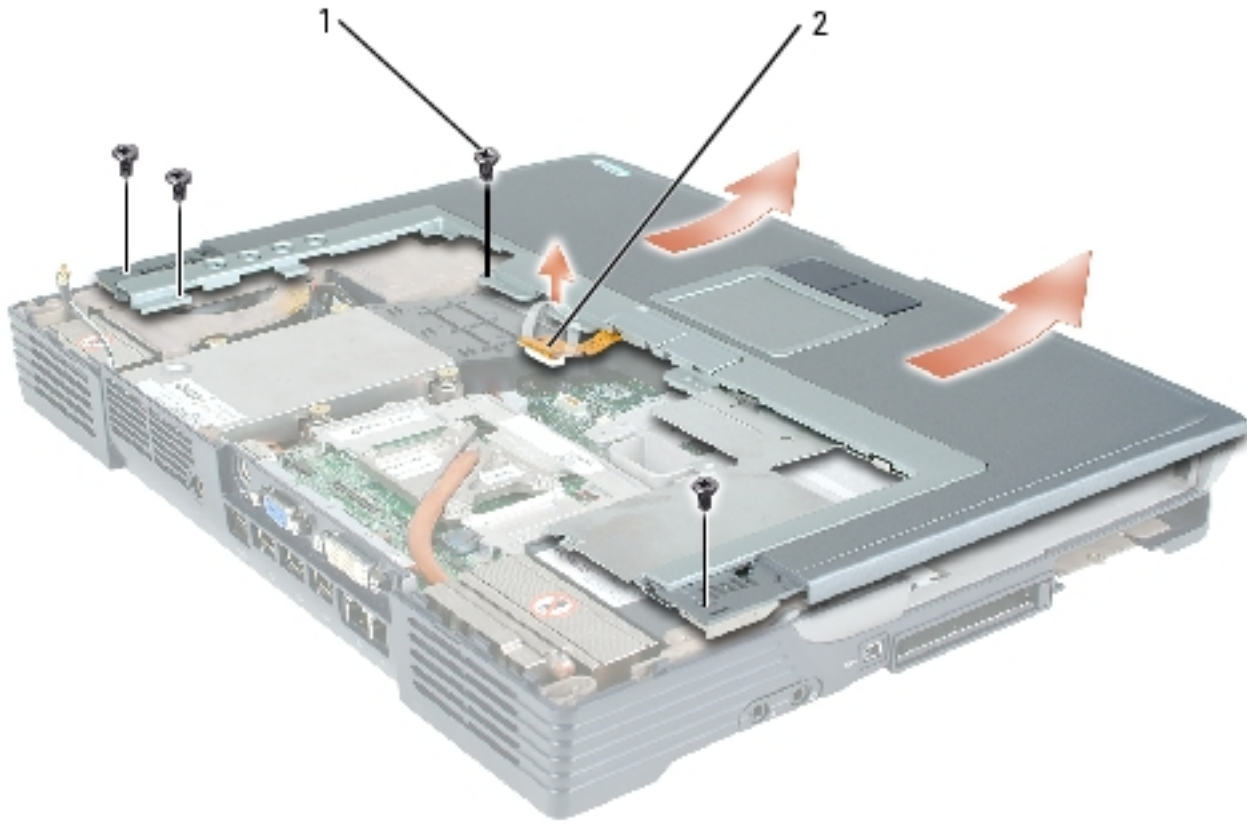

1	M2.5 x 6-mm screws (4)
---	------------------------

2	touch-pad connector
---	---------------------

[Back to Contents Page](#)

[Back to Contents Page](#)

Video Card

Dell™ Inspiron™ XPS and Inspiron 9100 Service Manual

 **CAUTION:** Before performing the following procedures, read the safety instructions in your *Owner's Manual*.

 **NOTICE:** To avoid electrostatic discharge, ground yourself by using a wrist grounding strap or by periodically touching an unpainted metal surface (such as the back panel) on the computer.

 **NOTICE:** To avoid damaging the system board, you must remove the main battery before you begin working inside the computer.

If you ordered a video card with your computer, it is already installed. To remove and replace a video card:

1. Follow the instructions in "[Preparing to Work Inside the Computer](#)."
2. Remove the left, right, and center [hinge covers](#).
3. Remove the [keyboard](#).
4. Remove the [display assembly](#).
5. Remove the [keyboard bracket](#).
6. Remove the four M2.5 x 6-mm screws from the video card.
7. Gently pull up the video card to remove it.

The video card heat sink is part of the video card assembly.

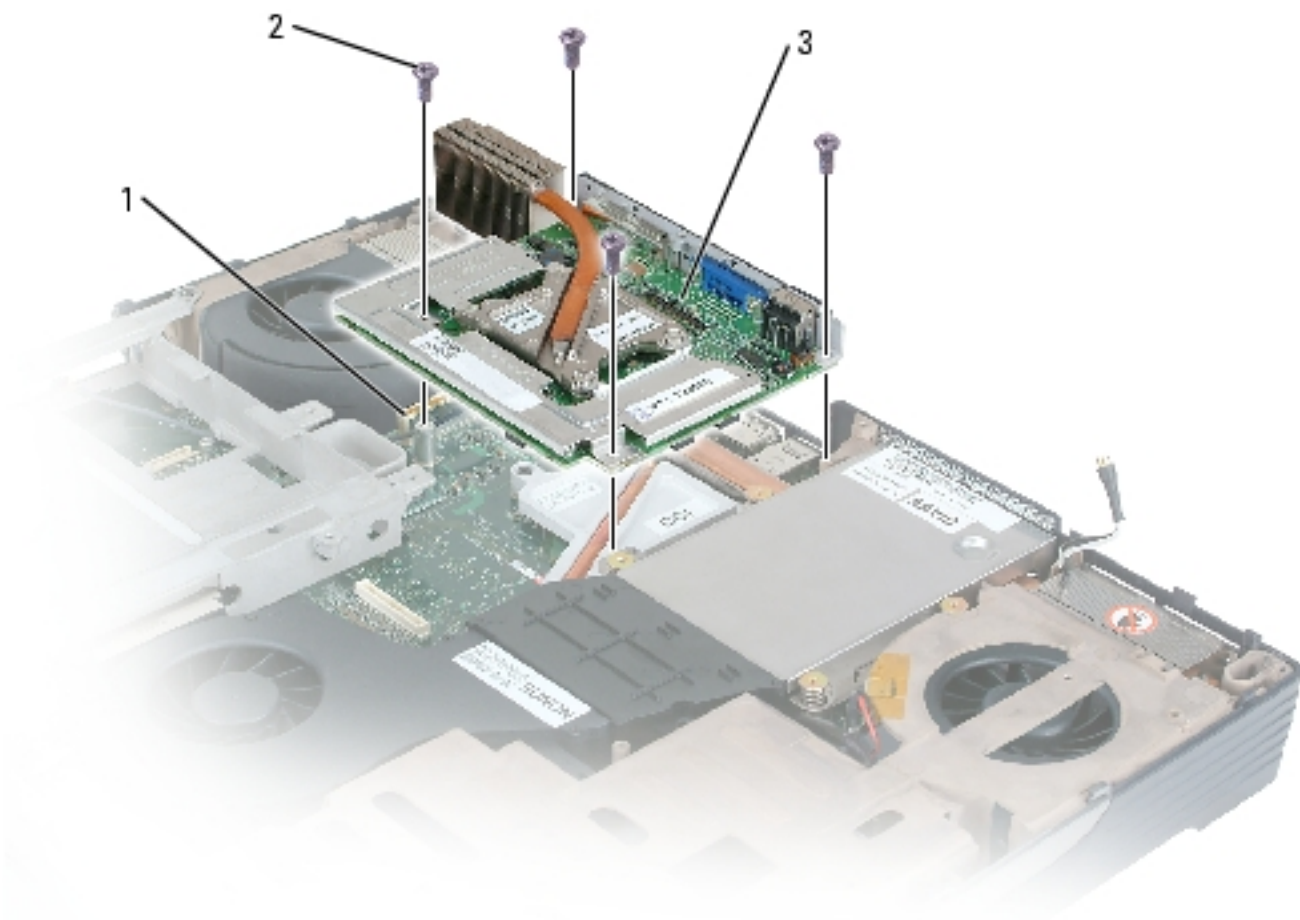

1	system board connector
2	M2.5 x 6-mm screws (4)
3	video card

[Back to Contents Page](#)

[Back to Contents Page](#)

Microprocessor Thermal-Cooling Assembly

Dell™ Inspiron™ XPS and Inspiron 9100 Service Manual

Removing the Microprocessor Thermal-Cooling Assembly



CAUTION: Before performing the following procedures, read the safety instructions in your *Owner's Manual*.



NOTICE: To avoid electrostatic discharge, ground yourself by using a wrist grounding strap or by periodically touching an unpainted metal surface (such as the back panel) on the computer.



NOTICE: To avoid damaging the system board, you must remove the main battery before you begin working inside the computer.

1. Follow the instructions in "[Preparing to Work Inside the Computer](#)."
2. Remove the left, right, and center [hinge covers](#).
3. Remove the [keyboard](#).
4. Remove the [display assembly](#).
5. Remove the [keyboard bracket](#).
6. Remove the [video card](#).
7. Loosen in consecutive order the four captive screws, labeled "1" through "4," that secure the microprocessor thermal-cooling assembly to the system board.
8. Lift up the microprocessor thermal-cooling assembly and remove it from the system board.

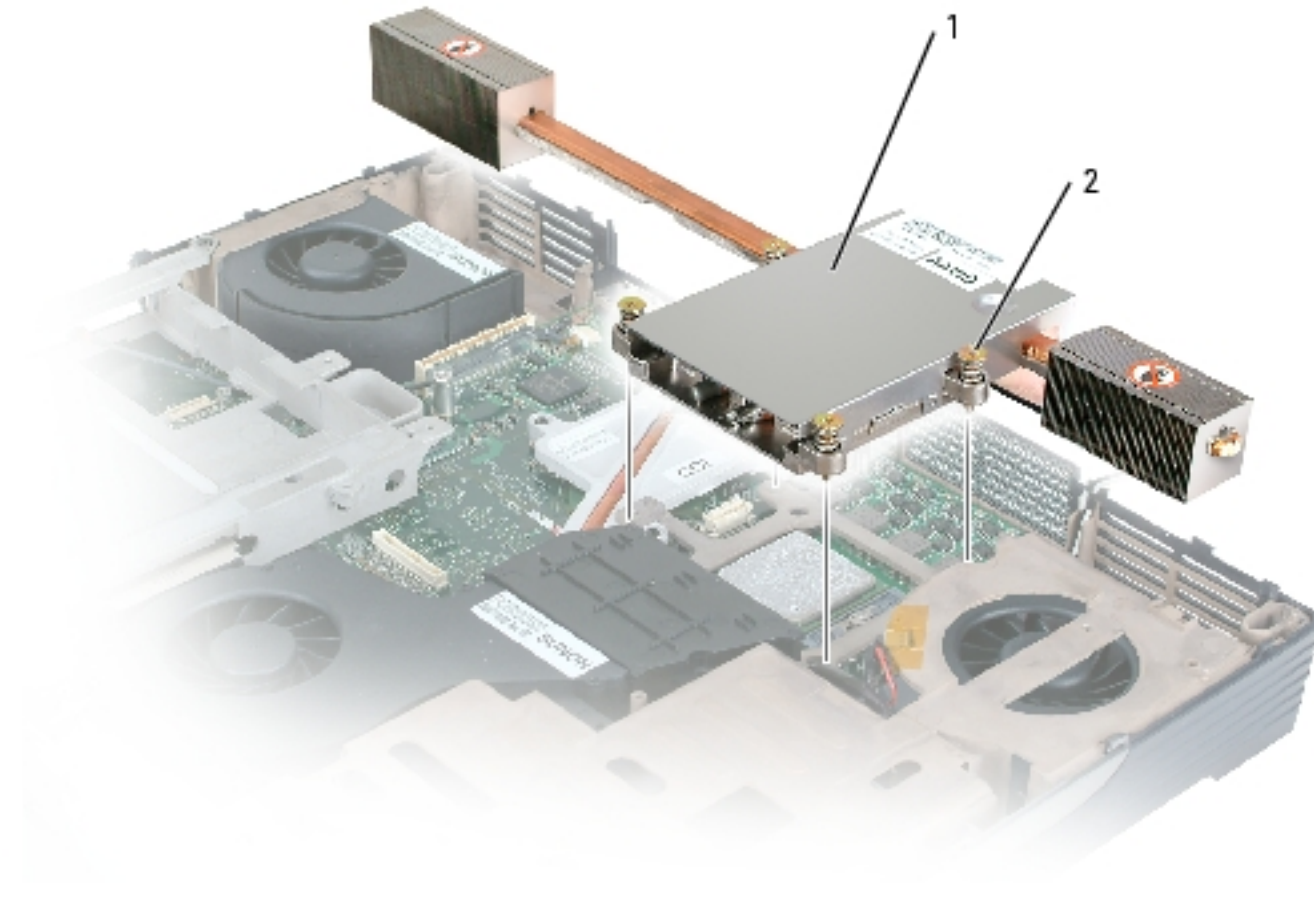

1	microprocessor thermal-cooling assembly
2	captive screws (4)

Installing the Microprocessor Thermal-Cooling Assembly

1. Evenly apply thermal grease to the top surface of the microprocessor.
2. Place the microprocessor thermal-cooling assembly over the microprocessor.
3. Tighten the four captive screws, labeled "1" through "4," in consecutive order.

[Back to Contents Page](#)

[Back to Contents Page](#)

Microprocessor Module

Dell™ Inspiron™ XPS and Inspiron 9100 Service Manual

Removing the Microprocessor Module

 **CAUTION:** Before performing the following procedures, read the safety instructions in your *Owner's Manual*.

 **NOTICE:** To avoid electrostatic discharge, ground yourself by using a wrist grounding strap or by periodically touching an unpainted metal surface (such as the back panel) on the computer.

 **NOTICE:** Do not touch the processor die. Press and hold the microprocessor down on the substrate on which the die is mounted while turning the cam screw to prevent intermittent contact between the cam screw and microprocessor.

 **NOTICE:** To avoid damage to the microprocessor, hold the screwdriver so that it is perpendicular to the microprocessor when turning the cam screw.

 **NOTICE:** To avoid damaging the system board, you must remove the main battery before you begin working inside the computer.

1. Follow the instructions in "[Preparing to Work Inside the Computer](#)."
2. Remove the left, right, and center [hinge covers](#).
3. Remove the [keyboard](#).
4. Remove the [display assembly](#).
5. Remove the [keyboard bracket](#).
6. Remove the [video card](#).

➔ **NOTICE:** To ensure maximum cooling for the microprocessor, do not touch the heat transfer areas on the microprocessor thermal-cooling assembly. The oils in your skin reduce the heat transfer capability of the thermal pads.

7. Remove the [microprocessor thermal-cooling assembly](#).

➔ **NOTICE:** When removing the microprocessor module, pull the module straight up. Be careful not to bend the pins on the microprocessor module.

8. To loosen the ZIF socket, use a small, flat-blade screwdriver and rotate the ZIF-socket cam screw counterclockwise until it comes to the cam stop.

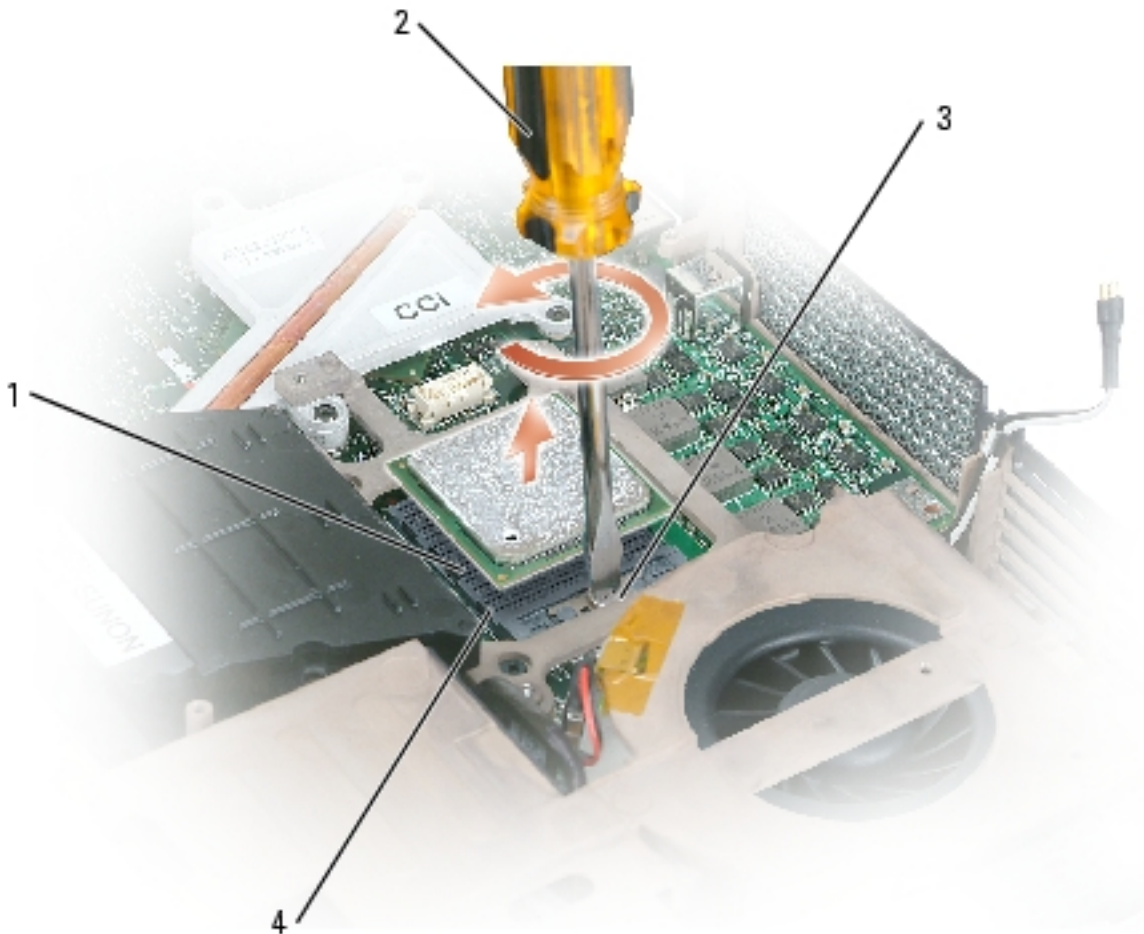

1	ZIF socket
---	------------

2	screwdriver (perpendicular to microprocessor)
3	ZIF-socket cam screw
4	pin-1 corner



NOTE: The ZIF-socket cam screw secures the microprocessor to the system board. Take note of the arrow on the ZIF-socket cam screw, which indicates the direction to turn the cam screw.

- Lift out the microprocessor module.

Installing the Microprocessor Module



NOTICE: Ensure that the cam lock is in the fully open position before seating the microprocessor module. Seating the microprocessor module properly in the ZIF socket does not require force.



NOTICE: A microprocessor module that is not properly seated can result in an intermittent connection or permanent damage to the microprocessor and ZIF socket.

- Align the pin-1 corner of the microprocessor module with the pin-1 corner of the ZIF socket, and insert the microprocessor module.



NOTE: The pin-1 corner of the microprocessor module has a triangle that aligns with the triangle on the pin-1 corner of the ZIF socket.



NOTICE: You must position the microprocessor module correctly in the ZIF socket to avoid permanent damage to the module and the socket.

When the microprocessor module is correctly seated, all four corners are aligned at the same height. If one or more corners of the module are higher than the others, the module is not seated correctly.

- Tighten the ZIF socket by turning the cam screw clockwise to secure the microprocessor module to the system board.

3. Perform the steps in "Removing the Microprocessor Module" in reverse order, beginning with [step 7](#).
 4. Update the BIOS using a flash BIOS update program floppy disk or CD. For instructions on how to flash the BIOS, see "[Flashing the BIOS](#)."
-

[Back to Contents Page](#)

[Back to Contents Page](#)

Speakers

Dell™ Inspiron™ XPS and Inspiron 9100 Service Manual

 **CAUTION:** Before performing the following procedures, read the safety instructions in your *Owner's Manual*.

 **NOTICE:** To avoid electrostatic discharge, ground yourself by using a wrist grounding strap or by periodically touching an unpainted metal surface (such as the back panel) on the computer.

 **NOTICE:** To avoid damaging the system board, you must remove the main battery before you begin working inside the computer.

1. Follow the instructions in "[Preparing to Work Inside the Computer](#)."
2. Remove the left, right, and center [hinge covers](#).
3. Remove the [keyboard](#).
4. Remove the [display assembly](#).
5. Remove the [keyboard bracket](#).
6. Remove the [palm rest](#).

 **NOTICE:** Handle the speakers with care to avoid damaging them.

7. Remove the three M2.5 x 6-mm screws from the speakers.
8. Gently pull up the speakers.
9. Disconnect the speaker connector from the system board connector.

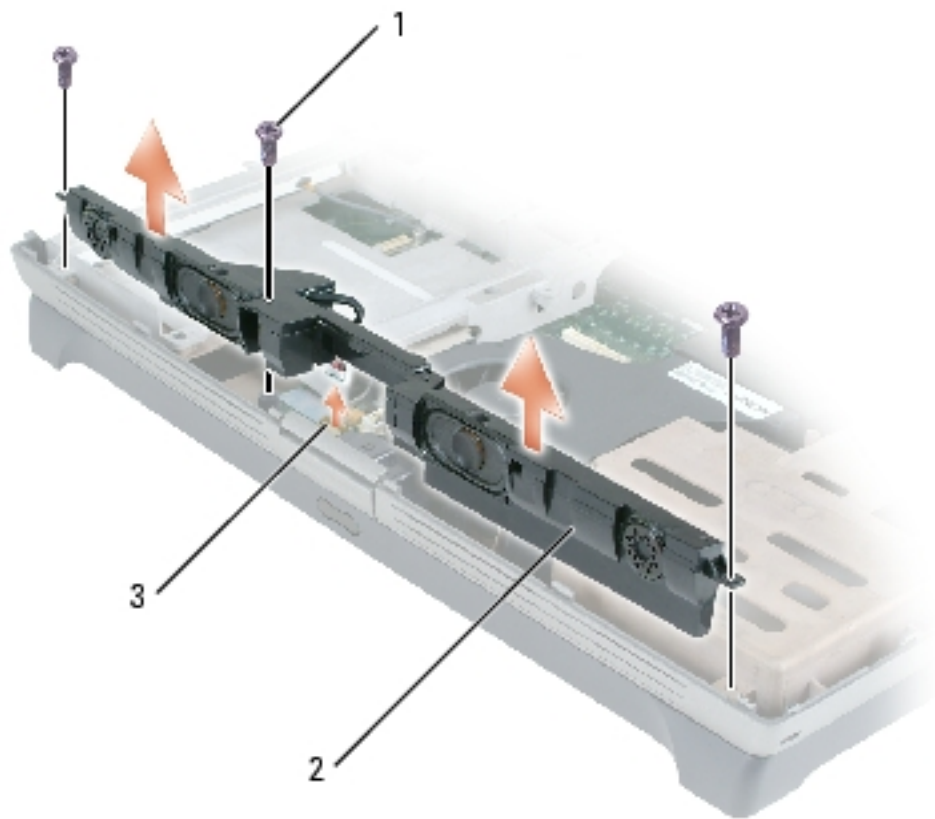

1	M2.5 x 6-mm screws (3)
2	speakers
3	speaker connector

[Back to Contents Page](#)

[Back to Contents Page](#)

Display Release Latch

Dell™ Inspiron™ XPS and Inspiron 9100 Service Manual



CAUTION: Before performing the following procedures, read the safety instructions in your *Owner's Manual*.



NOTICE: To avoid electrostatic discharge, ground yourself by using a wrist grounding strap or by periodically touching an unpainted metal surface (such as the back panel) on the computer.



NOTICE: To avoid damaging the system board, you must remove the main battery before you begin working inside the computer.

1. Follow the instructions in "[Preparing to Work Inside the Computer](#)."
2. Remove the left, right, and center [hinge covers](#).
3. Remove the [keyboard](#).
4. Remove the [display assembly](#).
5. Remove the [keyboard bracket](#).
6. Remove the [palm rest](#).
7. Remove the [speakers](#).
8. Remove the two M2.5 x 6-mm screws from either side of the display release latch.
9. Pull the display release latch straight up and away from the computer base.

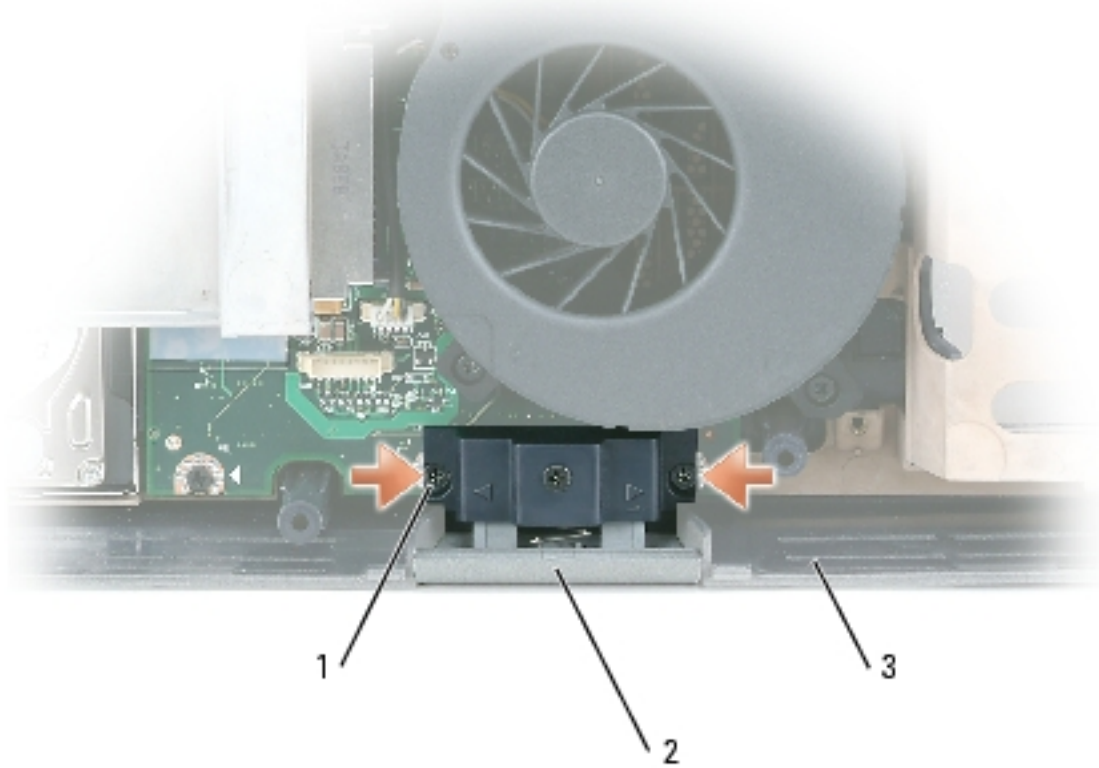

1	M2.5 x 6-mm screws (2)
2	display release latch
3	computer base

[Back to Contents Page](#)

[Back to Contents Page](#)

System Board

Dell™ Inspiron™ XPS and Inspiron 9100 Service Manual

Removing the System Board

 **CAUTION:** Before performing the following procedures, read the safety instructions in your *Owner's Manual*.

 **NOTICE:** To avoid electrostatic discharge, ground yourself by using a wrist grounding strap or by periodically touching an unpainted metal surface (such as the back panel) on the computer.

 **NOTICE:** To avoid damaging the system board, you must remove the main battery before you begin working inside the computer.

The system board's BIOS chip contains the Service Tag, which is also visible on a barcode label on the bottom of the computer. The replacement kit for the system board includes a CD that provides a utility for transferring the Service Tag to the replacement system board.

1. Follow the instructions in "[Preparing to Work Inside the Computer](#)."
2. Remove the left, right, and center [hinge covers](#).
3. Remove the [keyboard](#).
4. Remove the [display assembly](#).
5. Remove the [keyboard bracket](#).
6. Remove the [palm rest](#).
7. Remove the [speakers](#).
8. Remove the [microprocessor thermal-cooling assembly](#).
9. Remove the [microprocessor](#).

10. Turn over the system and remove the two M2.5 x 6-mm screws from the bottom system board assembly.

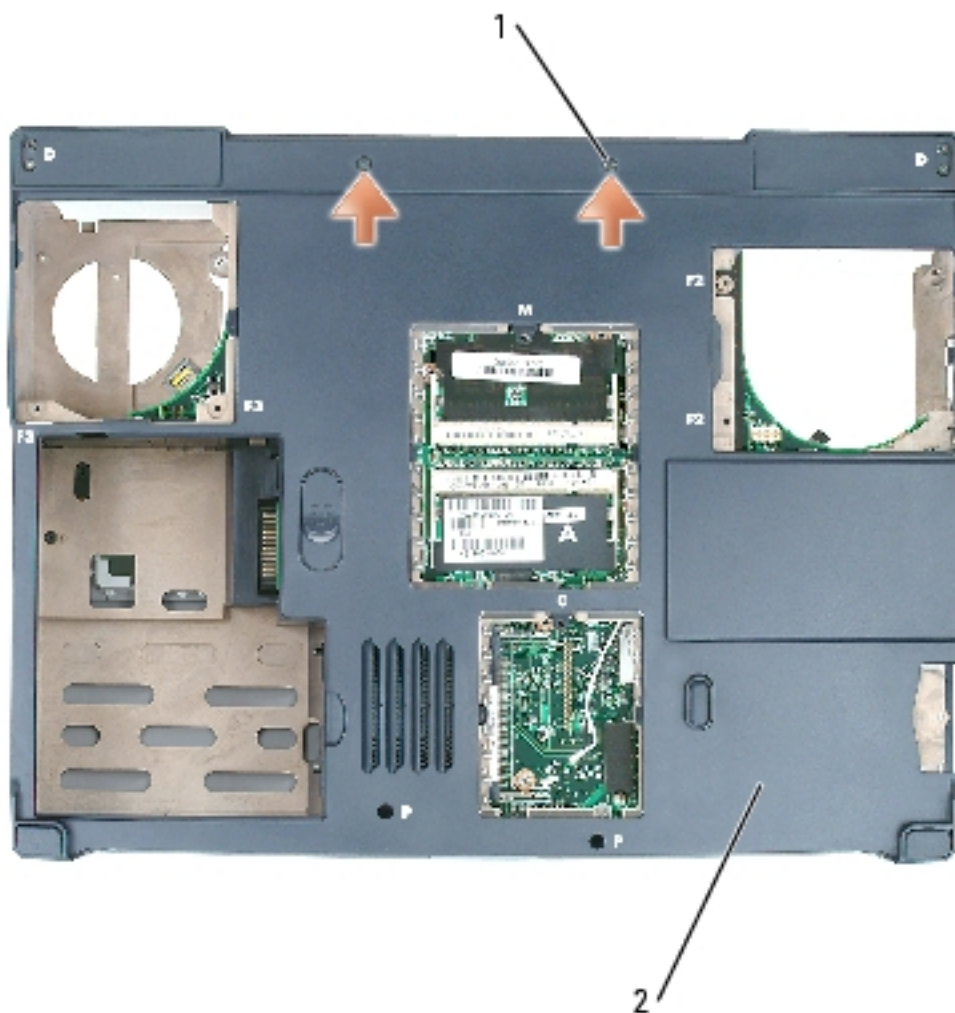

1	M2.5 x 6-mm screws (2)
2	system board bottom assembly

11. Turn over the system again and remove the four M2.5 x 6-mm screws from the top assembly.

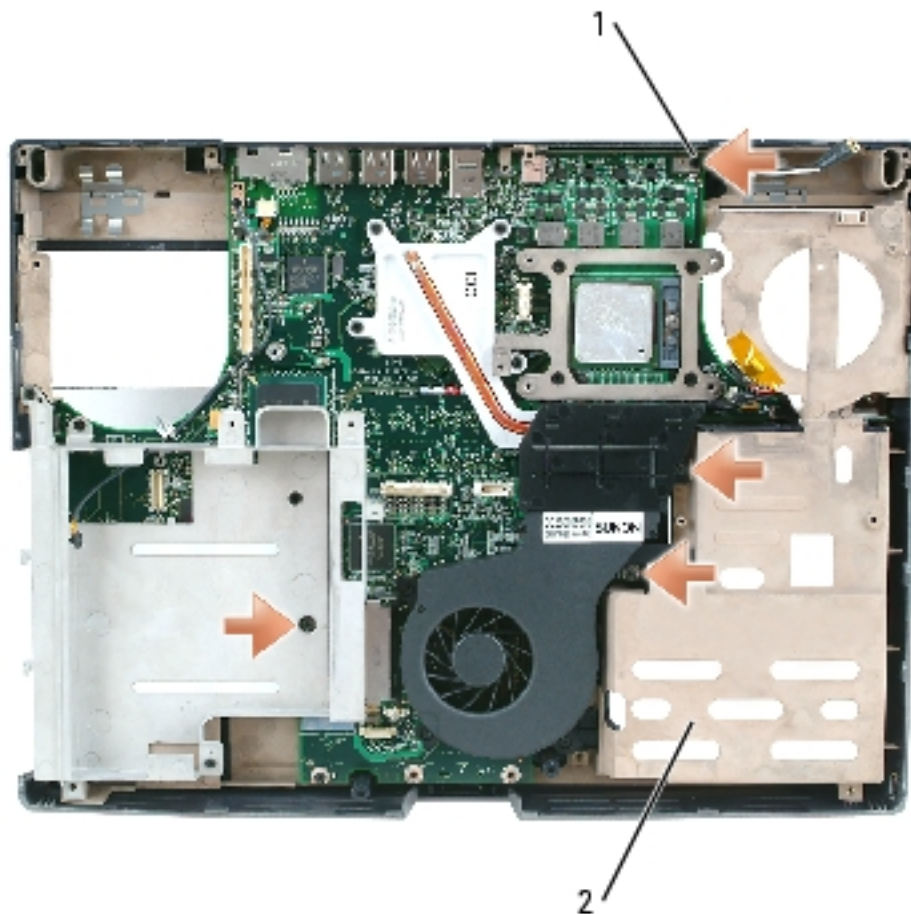

1	M2.5 x 6-mm screws (4)
2	system board top assembly

12. With the front of the computer facing you, lift the system board assembly from the right side, swinging it up, then lift the left side and draw the system board assembly out of the computer.

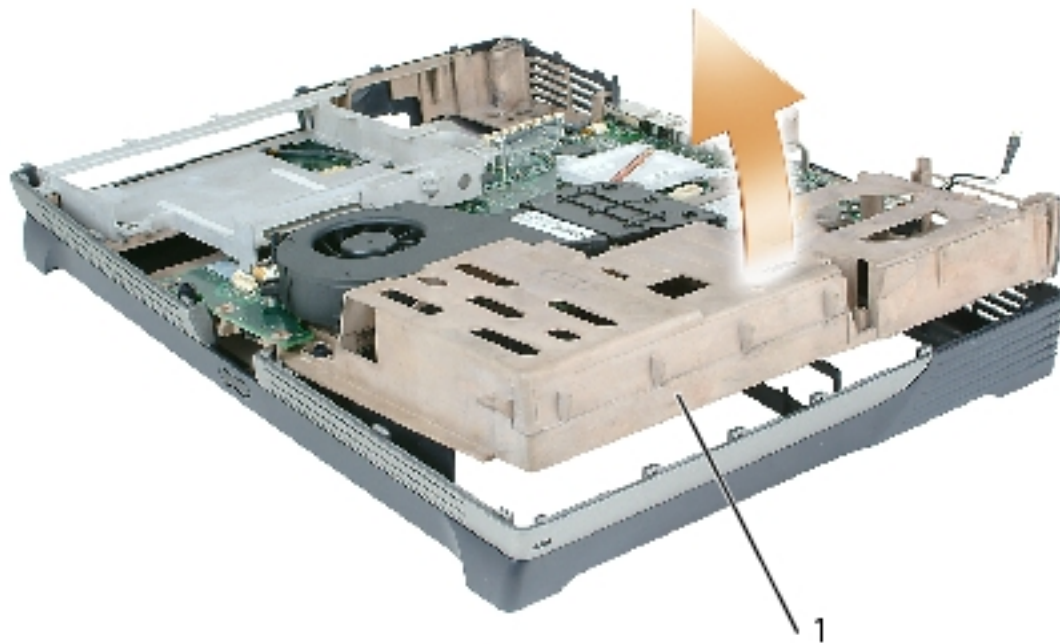

1 system board assembly

Installing the System Board

1. Perform all of the steps in "[Removing the System Board](#)" in reverse order.

 **NOTICE:** Before turning on the computer, replace all screws and ensure that no stray screws remain inside the computer. Failure to do so may result in damage to the computer.

2. Turn on the computer.

 **NOTE:** After replacing the system board, enter the computer Service Tag sequence into the BIOS of the replacement system board.

3. Insert the floppy disk or CD that accompanied the replacement system board into the appropriate drive. Follow the instructions that appear on the screen.

[Back to Contents Page](#)

[Back to Contents Page](#)

Flashing the BIOS

Dell™ Inspiron™ XPS and Inspiron 9100 Service Manual

1. Ensure that the AC adapter is plugged in and that the main battery is installed properly.



NOTE: If you use a BIOS update program CD to flash the BIOS, set up the computer to boot from a CD before inserting the CD.

2. Insert the BIOS update program floppy disk or CD, and turn on the computer.

Follow the instructions that appear on the screen. The computer continues to boot and updates the new BIOS. When the flash update is complete, the computer will automatically reboot.

3. Press <F2> during POST to enter the system setup program.
4. Press <Alt> and <f> to reset the computer defaults.
5. Press <Esc>, select **Save changes and reboot**, and press <Enter> to save configuration changes.
6. Remove the flash BIOS update program floppy disk or CD from the drive and restart the computer.

[Back to Contents Page](#)

[Back to Contents Page](#)

Pin Assignments for I/O Connectors

Dell™ Inspiron™ XPS and Inspiron 9100 Service Manual

- [USB Connector](#)
 - [Video Connector](#)
 - [S-Video TV-Out Connector](#)
 - [IEEE 1394 Connector](#)
 - [DVI-I Connector](#)
-

USB Connector

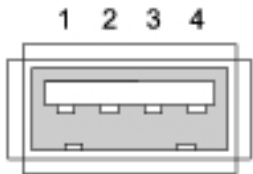

Pin	Signal
1	USB5V+
2	USBP-
3	USBP+
4	GND

Video Connector

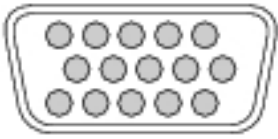

5 — 1
 10 — 6
 15 — 11

Pin	Signal	Pin	Signal
1	CRT_R	9	5V+
2	CRT_G	10	GND
3	CRT_B	11	MONITOR_DETECT-
4	NC	12	DDC_DATA
5	GND	13	CRT_HS
6	GND	14	CRT_VS
7	GND	15	DDC_CLK
8	GND		

S-Video TV-Out Connector

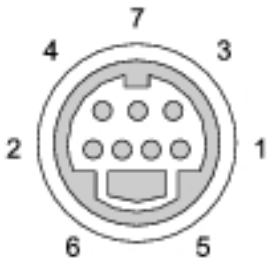

S-Video

Pin	Signal
-----	--------

1	GND
2	GND
3	DLUMA-L
4	DCRMA-L

Composite Video

Pin	Signal
5	NC
6	DCMPS-L
7	GND

IEEE 1394 Connector

1 2 3 4

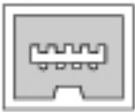

Pin	Signal
1	TPB-
2	TPB+
3	TPA-
4	TPA+

DVI-I Connector

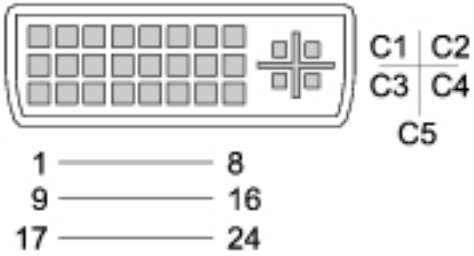

Pin	Signal	Pin	Signal
1	TMDS DATA2-	13	TMDS DATA3+
2	TMDS DATA2+	14	+ 5V
3	TMDS DATA2/4 SHLD	15	GND (FOR +5V)
4	TMDS DATA4-	16	HOT PLUG DETECT
5	TMDS DATA4+	17	TMDS DATA0-
6	DDC CLK	18	TMDS DATA0+
7	DDC DATA	19	TMDS DATA0/5 SHLD
8	ANALOG VERT SYNC	20	TMDS DATA5-
9	TMDS DATA1-	21	TMDS DATA5+
10	TMDS DATA1+	22	TMDS CLK SHLD
11	TMDS DATA1/3 SHLD	23	TMDS CLK+
12	TMDS DATA3-	24	TMDS CLK-

Pin	Signal
C1	ANALOG RED VID OUT
C2	ANALOG GRN VID OUT
C3	ANALOG BLU VID OUT
C4	ANALOG HOR SYNC

C5	ANALOG COM GND RET
----	--------------------

[Back to Contents Page](#)