

# eMachines E628 Series Service Guide

Service guide files and updates are available on the ACER/CSD web; for more information, please refer to <http://csd.acer.com.tw>

PRINTED IN TAIWAN

---

# Revision History

Please refer to the table below for the updates made on this service guide.

Date	Chapter	Updates

---

## Copyright

Copyright © 2009 by Acer Incorporated. All rights reserved. No part of this publication may be reproduced, transmitted, transcribed, stored in a retrieval system, or translated into any language or computer language, in any form or by any means, electronic, mechanical, magnetic, optical, chemical, manual or otherwise, without the prior written permission of Acer Incorporated.

## Disclaimer

The information in this guide is subject to change without notice.

Acer Incorporated makes no representations or warranties, either expressed or implied, with respect to the contents hereof and specifically disclaims any warranties of merchantability or fitness for any particular purpose. Any Acer Incorporated software described in this manual is sold or licensed "as is". Should the programs prove defective following their purchase, the buyer (and not Acer Incorporated, its distributor, or its dealer) assumes the entire cost of all necessary servicing, repair, and any incidental or consequential damages resulting from any defect in the software.

Acer is a registered trademark of Acer Corporation.

Other brand and product names are trademarks and/or registered trademarks of their respective holders.

---

## Conventions

The following conventions are used in this manual:

<b>SCREEN MESSAGES</b>	Denotes actual messages that appear on screen.
<b>NOTE</b>	Gives bits and pieces of additional information related to the current topic.
<b>WARNING</b>	Alerts you to any damage that might result from doing or not doing specific actions.
<b>CAUTION</b>	Gives precautionary measures to avoid possible hardware or software problems.
<b>IMPORTANT</b>	Reminds you to do specific actions relevant to the accomplishment of procedures.

---

## Preface

Before using this information and the product it supports, please read the following general information.

1. This Service Guide provides you with all technical information relating to the BASIC CONFIGURATION decided for Acer's "global" product offering. To better fit local market requirements and enhance product competitiveness, your regional office MAY have decided to extend the functionality of a machine (e.g. add-on card, modem, or extra memory capability). These LOCALIZED FEATURES will NOT be covered in this generic service guide. In such cases, please contact your regional offices or the responsible personnel/channel to provide you with further technical details.
2. Please note WHEN ORDERING FRU PARTS, that you should check the most up-to-date information available on your regional web or channel. If, for whatever reason, a part number change is made, it will not be noted in the printed Service Guide. For ACER-AUTHORIZED SERVICE PROVIDERS, your Acer office may have a DIFFERENT part number code to those given in the FRU list of this printed Service Guide. You MUST use the list provided by your regional Acer office to order FRU parts for repair and service of customer machines.



<b>System Specifications</b>	<b>1</b>
Features	1
System Block Diagram	4
Your Notebook Tour	5
Front View	5
Closed Front View	6
Left View	6
Right View	7
Base View	8
Rear View	8
Indicators	9
TouchPad Basics	10
Using the Keyboard	11
Lock Keys and embedded numeric keypad	11
Windows Keys	12
Hot Keys	13
Special Keys	14
Hardware Specifications and Configurations	15
 <b>System Utilities</b>	 <b>23</b>
BIOS Setup Utility	23
Navigating the BIOS Utility	23
Information	24
Main	25
Advanced	26
Security	28
Power	31
Boot	32
Exit	33
BIOS Flash Utility	34
DOS Flash Utility	35
WinFlash Utility	36
Remove HDD/BIOS Password Utilities	37
Removing BIOS Passwords:	38
Miscellaneous Utilities	39
 <b>Machine Disassembly and Replacement</b>	 <b>42</b>
Disassembly Requirements	42
Related Information	42
General Information	43
Pre-disassembly Instructions	43
Disassembly Process	43
External Module Disassembly Process	44
External Modules Disassembly Flowchart	44
Removing the Battery Pack	45
Removing the Hard Disk Drive Module	46
Removing the Optical Disk Drive Module	49
Removing the DIMM Module	52
Removing the WLAN Board	55
Main Unit Disassembly Process	58
Main Unit Disassembly Flowchart	58
Removing the Keyboard	60
Removing the Upper Cover	62
Removing the Button Board	66

# Table of Contents

Removing the Touchpad Bracket	68
Removing the Power Board	70
Removing the Speaker Modules	72
Removing the Media Board	74
Removing the I/O Board	76
Removing the DC-In Cable	79
Removing the Mainboard	80
Removing the LCD Module	83
Removing the Fan	85
Removing the Thermal Module	87
Removing the CPU	88
LCD Module Disassembly Process	89
LCD Module Disassembly Flowchart	89
Removing the LCD Bezel	90
Removing the Camera Board	93
Removing the LCD Panel	94
Removing the FPC Cable	95
Removing the LCD Brackets	97
Removing the Microphone	98
Removing the Antennas	100
LCD Module Reassembly Procedure	102
Replacing the Antennas	102
Replacing the Microphone	103
Replacing the LCD Brackets	105
Replacing the FPC Cable	106
Replacing the LCD Panel	107
Replacing the Camera Board	108
Replacing the LCD Bezel	109
Main Unit Reassembly Process	111
Replacing the LCD Module	111
Replacing the CPU	113
Replacing the Thermal Module	113
Replacing the Fan	115
Replacing the Mainboard	117
Replacing the I/O Board	120
Replacing the Media Board	122
Replacing the Speaker Modules	123
Replacing the Power Board	125
Replacing the Touchpad Bracket	126
Replacing the Button Board	128
Replacing the Upper Cover	130
Replacing the Keyboard	134
External Module Reassembly Process	136
Replacing the WLAN Board	136
Replacing the DIMM Modules	137
Replacing the Hard Disk Drive Module	139
Replacing the ODD	141
Replacing the Lower Covers	143
Replacing the Battery	145
<b>Troubleshooting</b>	<b>148</b>
Common Problems	148
Power On Issue	149
No Display Issue	150
Random Loss of BIOS Settings	151



# Table of Contents

LCD Failure . . . . .	152
Built-In Keyboard Failure . . . . .	152
Touchpad Failure . . . . .	153
Internal Speaker Failure . . . . .	153
Internal Microphone Failure . . . . .	155
HDD Not Operating Correctly . . . . .	156
ODD Failure . . . . .	157
USB Failure (Right side) . . . . .	160
Wireless Function Failure . . . . .	161
Bluetooth Function Failure . . . . .	162
Easy Button Failure . . . . .	162
Thermal Unit Failure . . . . .	163
External Mouse Failure . . . . .	164
Other Failures . . . . .	164
Intermittent Problems . . . . .	164
Undetermined Problems . . . . .	165
POST Code Tables . . . . .	166
Sec . . . . .	166
Memory . . . . .	166
DLL Timing Control Registers, RCOMP settings . . . . .	167
BDS & Specific action: . . . . .	168
Each PEIM entry point used in 80_PORT . . . . .	168
<b>Jumper and Connector Locations</b>	<b>173</b>
Top View . . . . .	173
Bottom View . . . . .	174
Clearing Password Check and BIOS Recovery . . . . .	175
Clearing Password Check . . . . .	175
BIOS Recovery by Crisis Disk . . . . .	176
<b>FRU (Field Replaceable Unit) List</b>	<b>177</b>
Aspire 5538 Exploded Diagrams . . . . .	178
Main Assembly . . . . .	178
LCD Assembly . . . . .	179
Aspire 5538 FRU List . . . . .	180
Screw List . . . . .	187
<b>Model Definition and Configuration</b>	<b>190</b>
<b>Test Compatible Components</b>	<b>206</b>
Windows XP Environment Test . . . . .	207
<b>Online Support Information</b>	<b>210</b>
<b>Index</b>	<b>211</b>

# ***Table of Contents***

# System Specifications

---

## Features

Below is a brief summary of the computer's many features:

### Operating System

- Genuine Windows Vista®

### Platform

- AMD Better By Design Program, featuring:
  - AMD Athlon™ 64 X2 dual-core processor\*
  - AMD Athlon™ 64 processor\*
  - AMD SB710 A13 / RS780MN Chipset
  - Acer InviLink™ Nplify™ 802.11b/g/Draft-N\*
  - Acer InviLink™ 802.11b/g\*

### System Memory

- Dual-Channel SDRAM support
- Up to 2 GB of DDR2 667 MHz memory, upgradeable to 4 GB using two SODIMM modules\*

### Display and graphics

- 16:9 aspect ratio
- 15.6" HD 1366 x 768
- ATI Radeon™ HD 3200 Graphics\*
- ATI Mobility Radeon™ HD 4330\*

### Storage subsystem

- 2.5" hard disk drive
- DVD-Super Multi double-layer drive
- 5-in-1 card reader

### Audio subsystem

- High-definition audio support
- S/PDIF (Sony/Philips Digital Interface) support for digital speakers
- MS-Sound compatible
- Built-in microphone

---

## Communication

- Integrated Crystal Eye webcam
- WLAN:
  - 802.11b/g/Draft-N\*
  - 802.11b/g\*
- WPAN: Bluetooth® 2.1+Enhanced Data Rate (EDR)\*
- LAN: Gigabit Ethernet; Wake-on-LAN ready

## Privacy control

- BIOS user, supervisor, HDD passwords
- Kensington lock slot

## Dimensions and Weight

- 380 (W) x 259 (D) x 26.4/30.8 (H) mm (14.82 x 10.1 x 1.02/1.2 inches)
- 2.4 kg (5.3 lbs.) with 6-cell battery pack

## Power subsystem

- ACPI 3.0
- 48.84 W 4400 mAh
- 3-pin 65 W AC adapter
- ENERGY STAR®\* compliant

## Special keys and controls

- 103-/104-/107-key keyboard
- Touchpad pointing device

## I/O interface

- 5-in-1 card reader (SD/MMC/MS/MS PRO/xD)
- USB 2.0 port
- HDMI™ port with HDCP support
- External display (VGA) port
- Headphones/speaker/line-out jack with S/PDIF support
- Microphone-in jack
- Ethernet (RJ-45) port
- DC-in jack for AC adapter

## Environment

- Temperature:
  - Operating: 5 °C to 35 °C
  - Non-operating: -20 °C to 65 °C
- Humidity (non-condensing):

- 
- Operating: 20% to 80%
  - Non-operating: 20% to 80%

**NOTE:** The specifications listed above are for reference only. The exact configuration of the PC depends on the model purchased.

# System Block Diagram

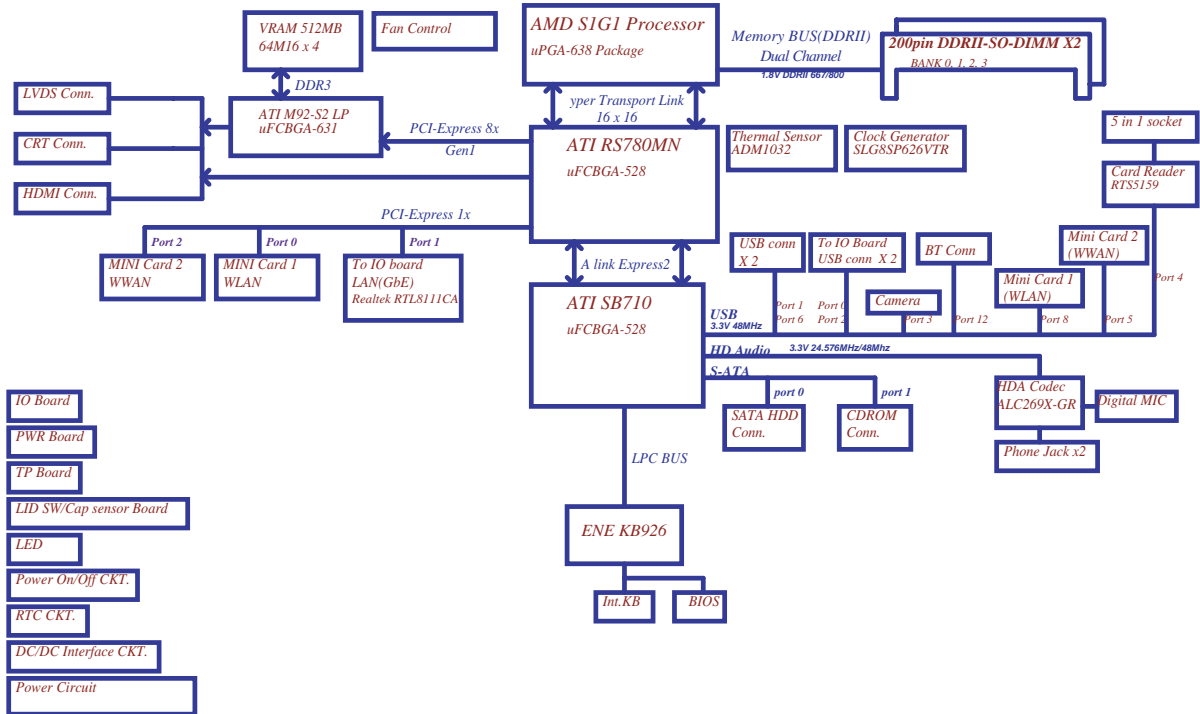





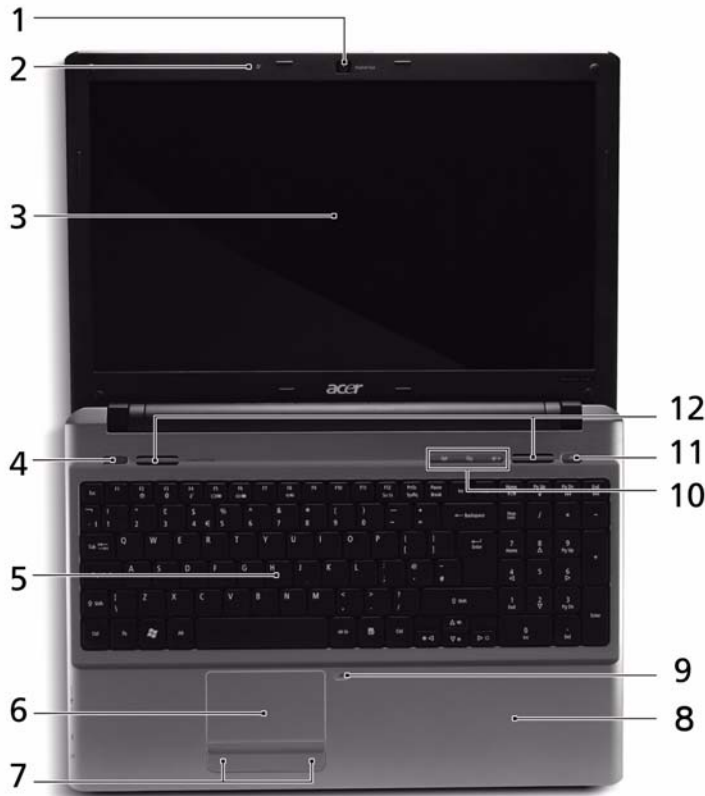

# Your Notebook Tour

This section provides an overview of the features and functions of the notebook.

## Front View





No.	Icon	Item	Description
1		Acer Crystal Eye Webcam	Web camera for video communication.
2		Microphone	Internal microphone for sound recording.
3		Display screen	Also called Liquid-Crystal Display (LCD), displays computer output.
4		Power button/ indicator	Turns the computer on and off while indicating the computer's power status.
5		Keyboard	For entering data into your computer.
6		TouchPad	Touch-sensitive pointing device which functions like a computer mouse.
7		Click buttons (left and right)	The left and right buttons function like the left and right mouse buttons.
8		Palmrest	Comfortable support area for your hands when you use the computer.
9		Touchpad toggle	Turns the internal touchpad on and off.

No.	Icon	Item	Description
10		Communication key	Enables / disables the WLAN function.
		Backup key	Launches Acer Backup Management for three-step data backup.
		HDD	Indicates when the hard disk drive is active.
7		Eject button	Presses to eject the optical disk from the drive.
8		Speakers	Left and right speakers deliver stereo audio output.

## Closed Front View





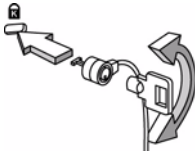

No.	Icon	Item	Description
1		Battery Indicator	Indicates the computer's battery status. 1. Charging: The light shows amber when the battery is charging. 2. Fully charged: The light shows blue when in AC mode.
2		5-in-1 card reader	Accepts Secure Digital (SD), MultiMediaCard (MMC), Memory Stick (MS), Memory Stick PRO (MS PRO), xD Picture Card (xD). Note: Push to remove/install the card. Only one card can operate at any given time.

## Left View





No.	Icon	Item	Description
1		Kensington Lock Slot 	Connects to a Kensington-compatible computer security lock. <b>Note:</b> Wrap the computer security lock cable around an immovable object such as a table or handle of a locked drawer. Insert the lock into the notch and turn the key to secure the lock. Some keyless models are also available.



No.	Icon	Item	Description
2		Ventilation slots	Enable the computer to stay cool, even after prolonged use.
3		External display (VGA) port	Connects to a display device (e.g., external monitor, LCD projector).
4	HDMI	HDMI port	Supports high definition digital video connections.
5		USB 2.0 port	Connect to USB 2.0 devices (e.g., USB mouse, USB camera).
6		Microphone-in jack	Accepts inputs from external microphones.
		Headphones/speaker/line-out jack with S/PDIF support	Connects to audio line-out devices (e.g., speakers, headphones).





## Right View

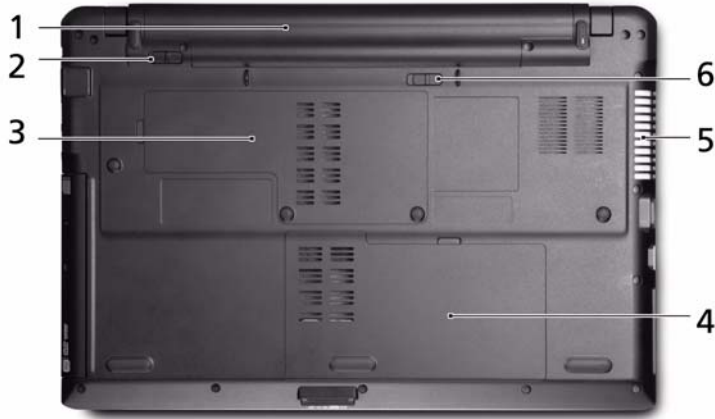

No.	Icon	Item	Description
1		Optical drive	Internal optical drive; accepts CDs or DVDs.
2		Optical disk access indicator	Lights up when the optical drive is active.
3		Emergency eject hole	Ejects the optical drive tray when the computer is turned off. Note: Insert a paper clip to the emergency eject hole to eject the optical drive tray when the computer is off.
4		USB 2.0 port	Connect to USB 2.0 devices (e.g., USB mouse, USB camera).
5		Ethernet (RJ-45) port	Connects to an Ethernet 10/100/1000- based network.
6		DC-in jack	Connects to an AC adapter.

## Base View



No.	Icon	Item	Description
1		Battery bay	Houses the computer's battery pack. <b>Note:</b> The battery shown is for reference only. Your PC may have a different battery, depending on the model purchased.
2		Battery lock	Locks the battery in position.
3		Memory compartment	Houses the computer's main memory.
4		Hard Disk Bay	Houses the computer's hard disk (secured with screws).
5		Ventilation slots and/or cooling fan	Enable the computer to stay cool, even after prolonged use. <b>Note:</b> Do not cover or obstruct the opening of the fan.
6		Battery Release Latch	Releases the battery for removal.

## Rear View



No.	Icon	Item	Description
1		Battery bay	Houses the computer's battery pack.

---

## Indicators

The computer has several easy-to-read status indicators. The battery indicator is visible even when the computer cover is closed.

Icon	Function	Description
	Bluetooth	Indicates the status of Bluetooth communication.
	Wireless LAN	Indicates the status of Wireless LAN communication.
	3G communication	Indicates the status of 3G communication.
	HDD	Indicates when the hard disk drive is active.
	Num Lock	Lights up when Num Lock is activated.
	Caps Lock	Lights up when Caps Lock is activated.
	Battery	Indicates the computer's battery status.

**NOTE:** 1. **Charging:** The battery light shows amber when the battery is charging. 2. **Fully charged:** The light shows green when in AC mode.

---

# TouchPad Basics

The following items show you how to use the TouchPad:

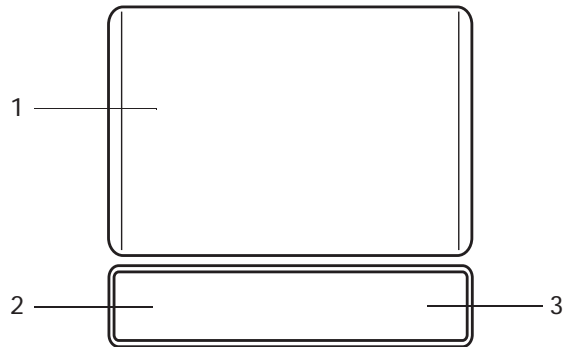

- Move your finger across the TouchPad (1) to move the cursor.
- Press the left (2) and right (3) buttons located beneath the TouchPad to perform selection and execution functions. These two buttons are similar to the left and right buttons on a mouse. Tapping on the TouchPad is the same as clicking the left button.

Function	Left Button (2)	Right Button (3)	Main TouchPad (1)
Execute	Quickly click twice.		Tap twice (at the same speed as double-clicking a mouse button).
Select	Click once.		Tap once.
Drag	Click and hold, then use finger on the TouchPad to drag the cursor.		Tap twice (at the same speed as double-clicking a mouse button); rest your finger on the TouchPad on the second tap and drag the cursor.
Access context menu		Click once.	

**NOTE:** When using the TouchPad, keep it - and your fingers - dry and clean. The TouchPad is sensitive to finger movement; hence, the lighter the touch, the better the response. Tapping too hard will not increase the TouchPad's responsiveness.

---

# Using the Keyboard

Your Acer Aspire Series notebook has a close-to-full-sized keyboard and an embedded numeric keypad, separate cursor, lock, function and special keys.

## Lock Keys and embedded numeric keypad

The keyboard has three lock keys which you can toggle on and off.













Lock key	Description
Caps Lock	When Caps Lock is on, all alphabetic characters typed are in uppercase.
Num Lock <Fn> + <F11>	When Num Lock is on, the embedded keypad is in numeric mode. The keys function as a calculator (complete with the arithmetic operators +, -, *, and /). Use this mode when you need to do a lot of numeric data entry. A better solution would be to connect an external keypad.
Scroll Lock <Fn> + <F12>	When Scroll Lock is on, the screen moves one line up or down when you press the up or down arrow keys respectively. Scroll Lock does not work with some applications.

The embedded numeric keypad functions like a desktop numeric keypad. It is indicated by small characters located on the upper right corner of the keycaps. To simplify the keyboard legend, cursor-control key symbols are not printed on the keys.

Desired access	Num Lock on	Num Lock off
Number keys on embedded keypad	Type numbers in a normal manner.	
Cursor-control keys on embedded keypad	Hold <Shift> while using cursor-control keys.	Hold <Fn> while using cursor-control keys.
Main keyboard keys	Hold <Fn> while typing letters on embedded keypad.	Type the letters in a normal manner.

# Windows Keys

The keyboard has two keys that perform Windows-specific functions.











Key	Description
 Windows key	<p>Pressed alone, this key has the same effect as clicking on the Windows Start button; it launches the Start menu. It can also be used with other keys to provide a variety of functions:</p> <ul style="list-style-type: none"><li>&lt;  &gt;: Open or close the Start menu</li><li>&lt;  &gt; + &lt;D&gt;: Display the desktop</li><li>&lt;  &gt; + &lt;E&gt;: Open Windows Explore</li><li>&lt;  &gt; + &lt;F&gt;: Search for a file or folder</li><li>&lt;  &gt; + &lt;L&gt;: Lock your computer (if you are connected to a network domain), or switch users (if you're not connected to a network domain)</li><li>&lt;  &gt; + &lt;M&gt;: Minimizes all windows</li><li>&lt;  &gt; + &lt;R&gt;: Open the Run dialog box</li><li>&lt;  &gt; + &lt;U&gt;: Open Ease of Access Center</li><li>&lt;  &gt; + &lt;BREAK&gt;: Display the System Properties dialog box</li><li>&lt;  &gt; + &lt;TAB&gt;: Cycle through programs on the taskbar</li><li>&lt;CTRL&gt; + &lt;  &gt; + &lt;F&gt;: Search for computers (if you are on a network)</li></ul> <p><b>Note:</b> Depending on your edition of Windows XP, some shortcuts may not function as described.</p>
 Application key	This key has the same effect as clicking the right mouse button; it opens the application's context menu.

---

# Hot Keys

The computer employs hotkeys or key combinations to access most of the computer's controls like screen brightness and volume output.

To activate hotkeys, press and hold the <Fn> key before pressing the other key in the hotkey combination.

Hotkey	Icon	Function	Description
<Fn> + <F2>		System Properties	Display the System Properties dialog box.
<Fn> + <F3>		Bluetooth communication switch	Enables/disables the Bluetooth function.
<Fn> + <F4>		Sleep	Puts the computer in Sleep mode.
<Fn> + <F5>		Display toggle	Switches display output between the display screen, external monitor (if connected) and both.
<Fn> + <F6>		Screen blank	Turns the display screen backlight off to save power. Press any key to return.
<Fn> + <F8>		Speaker toggle	Turns the speakers on and off.
<Fn> + <↑>		Brightness up	Increases the screen brightness.
<Fn> + <↓>		Brightness down	Decreases the screen brightness.
<Fn> + <→>		Volume up	Increases the sound volume.
<Fn> + <←>		Volume down	Decreases the sound volume.

---

## Special Keys

You can locate the Euro symbol and the US dollar sign at the upper-center and/or bottom-right of your keyboard.

### The Euro symbol

1. Open a text editor or word processor.
2. Hold <Alt Gr> and then press the <5> key at the upper-center of the keyboard.

**NOTE:** Some fonts and software do not support the Euro symbol. See [www.microsoft.com/typography/faq/faq12.htm](http://www.microsoft.com/typography/faq/faq12.htm) for more information.

### The US dollar sign

1. Open a text editor or word processor.
2. Hold <Shift> and then press the <4> key at the upper-center of the keyboard.

**NOTE:** This function varies according to the language settings.



# Hardware Specifications and Configurations

## Processor

Item	Specification
CPU type	AMD S1g1 processor
CPU package	638-pin lidless micro PGA package.
Chipset	AMD RS780MN Northbridge AMD SB710 A13 Southbridge

## Processor Specifications

Item	CPU Speed	Cores	Mfg. Tech	Cache Size	Package	Core Voltage	Acer P/N
L110	1.2 GHz	1	65 nm	512 kB	Micro-PGA	Variable	KC.AL002.110
L310	1.2 GHz	2	65 nm	1 MB	Micro-PGA	Variable	KC.AL002.310
TF20	1.6 GHz	1	65 nm	512 kB	Micro-PGA	Variable	KC.ATF02.200

## CPU Fan True Value Table

CPU Temperature (Celsius)	Fan Speed (RPM)	SPL Spec (dBA)
45	3100	28
50	3500	31
55	3900	34
63	4400	37
75	4700	40

Throttling 50%: On= 90°C; OFF=80°C

OS shut down at 95°C; H/W shut down at 87°C

## North Bridge Specifications

Item	Specification
Chipset	AMD RS780MN chipset.
Package	21MM 528-FCBGA
Features	<ul style="list-style-type: none"><li>• CPU HyperTransport™ Interface</li><li>• Support for DDR2 memories up to DDR2-800</li><li>• ATI HyperMemory™</li><li>• Supports PCI-E Gen2 (version 2.0).</li><li>• A-Link Express II Interface</li></ul>

## South Bridge Specifications

Item	Specification
Chipset	AMD SB710 A13 chipset
Package	21MM 528-FCBGA

Item	Specification
Features	<ul style="list-style-type: none"> <li>• A-Link Express II interface</li> <li>• Supports PCI bus at 33 MHz</li> <li>• 5 OHCI and 2 EHCI Host controllers to supports 12 USB 2.0 ports and 2 dedicated USB 1.1 ports</li> <li>• SMBus Rev. 2.0 compliant</li> <li>• Supports IOAPIC/X-IO APIC mode for 24 channels of interrupts</li> <li>• Two cascaded 8237 DMA controllers</li> <li>• Supports LPC based super I/O and flash devices</li> <li>• Supports six SATA ports with transfer rates up to 3 Gb/s</li> <li>• Supports integrated RAID 0, RAID 1, and RAID 10 (requires use of 4 or more SATA ports) functionalities across all 6 ports.</li> <li>• ACPI specification 3.0 compliant power management schemes</li> <li>• High Definition Audio</li> </ul>

### System Memory

Item	Specification
Memory size	Up to 8GB
DIMM socket number	2
Supports memory size per socket	512MB / 1024MB / 2048MB / 4096MB
Supports maximum memory size	8GB
Supports DIMM type	200-pin +1.8V DDRII SODIMM
Supports DIMM Speed	667MHZ

### Video Specifications

Item	Specification
Chipset	Integrated VGA solution for AMD RS780MN (UMA). On board VGA solution for ATI M92-S2 LP (DIS).
Package	21MM 528-FCBGA (Integrated with Northbridge)
Features	<ul style="list-style-type: none"> <li>• Highly-optimized 128-bit engine, capable of processing multiple pixels per clock.</li> <li>• Fully DirectX 10.0 compliant, including full speed 32-bit floating point per component operations</li> <li>• Support for OpenGL® 2.0</li> <li>• Motion Video Acceleration for HD DVD/Blu-ray technology</li> <li>• Adjustable 128MB UMA VGA memory share from North Bridge.</li> <li>• Adjustable 512MB DIS VGA memory share from North Bridge.</li> <li>• Max resolution 2048x1536 @85Hz (pixel clock at 388.5MHz) for 4:3 format, 2560x1440 @75Hz (pixel clock at 397.25MHz) for 16:9 format, and 2456x1536 @60Hz (pixel clock at 320MHz) for 16:10 format</li> </ul>

### Hard Disk Drive Interface

Item	Specifications			
Vendor & Model Name	Hitachi HTS545050B9A300	Hitachi HTS545032B9A300	Hitachi HTS545025B9A300	Hitachi HTS545016B9A300
Capacity (MB)	500	320	250	160

Item	Specifications			
Bytes per sector	512			
Data heads	4	3	2	2
Drive Format				
Disks	2	2	1	1
Spindle speed (RPM)	5400			
Performance Specifications				
Buffer size	8MB			
Interface	SATA			
Internal transfer rate (Mbits/sec, max)	3GB/s maximum			
I/O data transfer rate (Mbytes/sec max)	875 Mbits/s maximum			845 Mbits/s maximum
DC Power Requirements				
Voltage	+5.0V ± 5%.			

Item	Specifications			
Vendor & Model Name	Seagate ST9160310AS	Seagate ST9250315AS	Seagate ST9320320AS	Seagate ST9500325AS
Capacity (MB)	160	250	320	500
Bytes per sector	512	512	512	512
Data heads	2	2	4	4
Drive Format				
Disks	1	1	2	2
Spindle speed (RPM)	5400	5400	5400	5400
Performance Specifications				
Buffer size	8 MB	8 MB	8MB	8 MB
Interface	SATA	SATA	SATA	SATA
Internal transfer rate (Mbits/sec, max)	830	1175	830	1175
I/O data transfer rate (Mbytes/sec max)	875 Mbits/s maximum			845 Mbits/s maximum
DC Power Requirements				
Voltage	+5.0V ± 5%.			

Item	Specifications			
Vendor & Model Name	Toshiba MK1655GSX	Toshiba MK2555GSX	Toshiba MK3255GSX	Toshiba MK5055GSX

Item	Specifications			
Capacity (MB)	160	250	320	500
Bytes per sector	512	512	512	512
Data heads	2	2	4	4
Drive Format				
Disks	1	1	2	2
Spindle speed (RPM)	5400			
Performance Specifications				
Buffer size	8MB			
Interface	SATA			
Internal transfer rate (Mbits/sec, max)	363 – 952 typical			
I/O data transfer rate (Mbytes/sec max)	300			
DC Power Requirements				
Voltage	5V ±5%			

Item	Specifications			
Vendor & Model Name	Western Digital WD1600BEVT-22ZCT0	Western Digital WD2500BEVT-22ZCT0	Western Digital WD3200BEVT-22ZCT0	Western Digital WD5000BEVT-22ZAT0
Capacity (MB)	160	250	320	500
Bytes per sector	512			
Data heads	2	4	3	4
Drive Format				
Disks	1	2	2	2
Spindle speed (RPM)	5400			
Performance Specifications				
Buffer size	8 MB			
Interface	SATA			
Internal transfer rate (Mbits/sec, max)	N/A			
I/O data transfer rate (Mbytes/sec max)	300			
DC Power Requirements				
Voltage	5V ±5%			

## Super-Multi Drive Module

Item	Specification			
Vendor & model name	HLDS GU10N		PANASONIC UJ892	
Performance Specification	With CD Diskette	With DVD Diskette	With CD Diskette	With DVD Diskette
Transfer rate (MB/sec)	Sustained:	Sustained:	Sustained:	Sustained:
Buffer Memory				
Interface				
Applicable disc formats	•			
Loading mechanism	Emergency Release (draw open hole)			
Power Requirement				
Input Voltage	DC 5 V +/- 5%			

## BIOS

Item	Specification
BIOS vendor	Insyde
BIOS Version	3.5
BIOS Features	<ul style="list-style-type: none"> <li>• Flash ROM 1MB</li> <li>• Support ISIPP</li> <li>• Support Acer UI</li> <li>• Support multi-boot</li> <li>• Suspend to RAM (S3) / Disk (S4)</li> <li>• Various hot-keys for system control</li> <li>• Support SMBUS 2.0, PCI2.3</li> <li>• ACPI 2.0 compliance with Intel Speed Step Support C1e, C2, C3 and S3, S4,S5 for mobile CPU.</li> <li>• DMI utility for BIOS serial number configuration/asset tag</li> <li>• Support PXE</li> <li>• Support Y2K solution</li> <li>• Support Win Flash Wake on LAN from S3</li> <li>• Wake on LAN form S4 in AC mode</li> <li>• System information</li> </ul>

## LED 15.6"

Item	Specifications		
Vendor/model name	AUO B156XW03 V1	LPL LP156WH3-TLA1	SAMSUNG LTN156AT07-A01
Screen Diagonal (mm.)			
Active Area (mm)			
Display resolution (pixels)			
Pixel Pitch (mm)			
Typical White Luminance (cd/m <sup>2</sup> ) also called Brightness			
Contrast Ratio			
Response Time (Optical Rise Time/Fall Time) msec			
Typical Power Consumption (watt)			

Item	Specifications		
Weight (without inverter)			
Physical Size (mm)			
Electrical Interface			
Viewing Angle (degree) Horizontal (Right) / (Left) Vertical (Upper) / (Lower)			

#### Audio Codec and Amplifier

Item	Specification
Audio Controller	Realtek ALC269X-GR for High Definition Audio Codec
Features	<ul style="list-style-type: none"> <li>• MIC IN <ul style="list-style-type: none"> <li>• AC-coupled input,100mVP-P maximum</li> </ul> </li> <li>• Headphone out <ul style="list-style-type: none"> <li>• 1VP-P</li> </ul> </li> <li>• Built-in Speaker <ul style="list-style-type: none"> <li>• 2 Watt/8cc Chamber</li> </ul> </li> </ul>

#### LAN Interface

Item	Specification
LAN Chipset	Realtek RTL8111CA-VB-GR GIGA LAN.
Package	Integrated on mainboard
Features	<ul style="list-style-type: none"> <li>• Supports 10/100/1000 mbps</li> </ul>

#### Keyboard

Item	Specification
Controller	ENE KB926 D3 Keyboard Controller
Total number of keypads	103/104/107
Windows logo key	Yes
Internal & external keyboard work simultaneously	Yes
Features	<ul style="list-style-type: none"> <li>• Supports Application keys for Windows XP version</li> </ul>

#### Mini Card

Item	Specification
Number Supported	1
Features	<ul style="list-style-type: none"> <li>• 1 for WLAN (full size)</li> </ul>

#### Camera

Item	Specifications
Vendor and model	Suyin Rose_2G
Type	CMOS image sensor
Interface	USB 2.0
Optical aperture	F/2.4
Focusing range	40CM - infinity
Dimensions (L x W x H mm)	65X 8.0X 3.79+/-0.2mm
Sensor type	CMOS

Item	Specifications
Pixel resolution	640 x 480
Pixel size	3.6um X3.6um
Image size	2.36mm(H) X1.76mm(V)

#### Wireless LAN

Item	Specification	Specification	Specification
Type	Foxconn FOX_ATH_XB63 Foxconn Atheros XB63 minicard b/g	Foxconn Wireless LAN Atheros AR5B91 1x2 BGN	Foxconn Wireless LAN Wireless LAN Ralink RT2700E 1x2 BGN

#### 802.11g

Radio Technology	
Operating Frequency	
Modulation Schemes	
Channel Numbers	•
Data Rate	
Media Access Protocol	
Transmitter Output Power	

#### 802.11b

Radio Technology	
Operating Frequency	
Modulation Schemes	
Channel Number	•
Data Rate	
Media Access Protocol	
Transmitter Output Power	

Item	Specification	Specification	Specification
Type	QMI Wireless LAN Atheros AR5B91 1x2 BGN (EM303)	Foxconn Wireless LAN Atheros HB93 1x2 BGN (HM)	Foxconn Wireless LAN Atheros HB95 1x1 BG (HM)

#### 802.11g

Radio Technology	
Operating Frequency	
Modulation Schemes	
Channel Numbers	•
Data Rate	
Media Access Protocol	

Item	Specification	Specification	Specification
Transmitter Output Power			
<b>802.11b</b>			
Radio Technology			
Operating Frequency			
Modulation Schemes			
Channel Number	•		
Data Rate			
Media Access Protocol			
Transmitter Output Power			

### Battery

Item	Specification
Vendor & model name	
Battery Type	Li-ion
Pack capacity	4400/5200 mAh
Number of battery cell	6
Package configuration	3S2P



# System Utilities

---

## BIOS Setup Utility

The BIOS Setup Utility is a hardware configuration program built into your computer's BIOS (Basic Input/Output System).

Your computer is already properly configured and optimized, and you do not need to run this utility. However, if you encounter configuration problems, you may need to run Setup. Please also refer to Chapter 4 Troubleshooting when problem arises.

To activate the BIOS Utility, press **F2** during POST (when **Press <F2> to enter Setup** message is prompted on the bottom of screen).

Press **F2** to enter setup. The default parameter of F12 Boot Menu is set to "disabled". If you want to change boot device without entering BIOS Setup Utility, please set the parameter to "enabled".

Press **<F12>** during POST to enter multi-boot menu. In this menu, user can change boot device without entering BIOS SETUP Utility.

## Navigating the BIOS Utility

There are six menu options: Information, Main, Advanced, Security, Power, Boot, and Exit.

Follow these instructions:

- To choose a menu, use the left and right arrow keys.
- To choose an item, use the up and down arrow keys.
- To change the value of a parameter, press **F5** or **F6**.
- A plus sign (+) indicates the item has sub-items. Press **Enter** to expand this item.
- Press **Esc** while you are in any of the menu options to go to the Exit menu.
- In any menu, you can load default settings by pressing **F9**. You can also press **F10** to save any changes made and exit the BIOS Setup Utility.

**NOTE:** You can change the value of a parameter if it is enclosed in square brackets. Navigation keys for a particular menu are shown on the bottom of the screen. Help for parameters are found in the Item Specific Help part of the screen. Read this carefully when making changes to parameter values. **Please note that system information is subject to different models.**

# Information

The Information screen displays a summary of your computer hardware information.

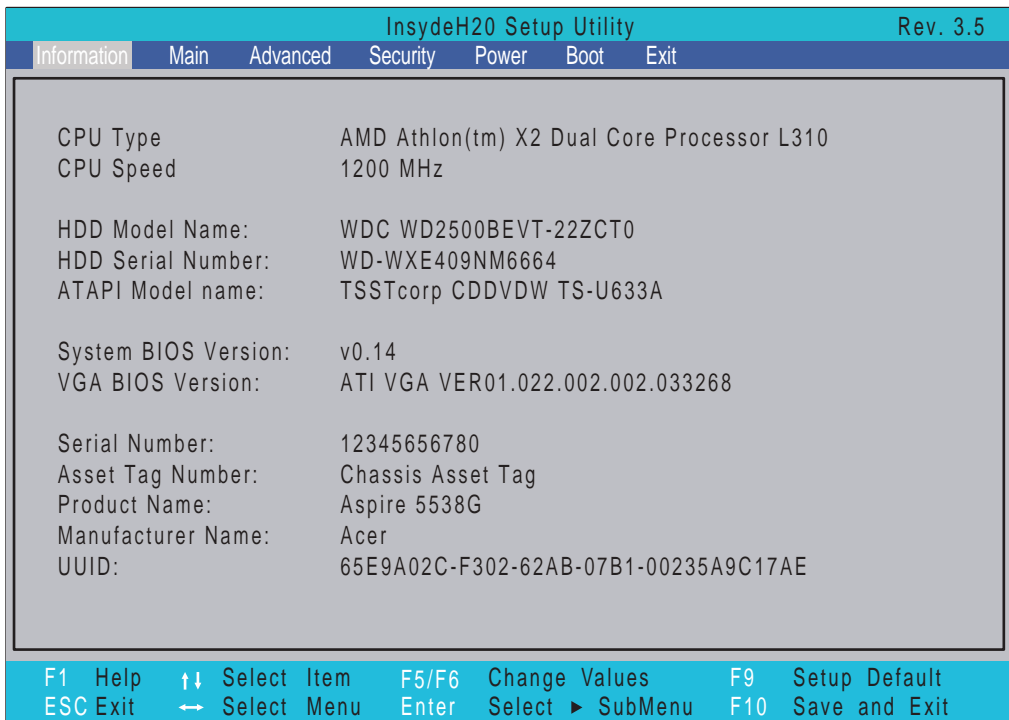

**NOTE:** The system information is subject to different models.

Parameter	Description
CPU Type	This field shows the CPU type and speed of the system.
CPU Speed	This field shows the speed of the CPU.
HDD Model Name	This field shows the model name of HDD installed on primary IDE master.
HDD Serial Number	This field displays the serial number of HDD installed on primary IDE master.
ATAPI Model Name	This field displays the model name of the installed ODD drive.
System BIOS Version	Displays system BIOS version.
VGA BIOS Version	This field displays the VGA firmware version of the system.
Serial Number	This field displays the serial number of this unit.
Asset Tag Number	This field displays the asset tag number of the system.
Product Name	This field shows product name of the system.
Manufacturer Name	This field displays the manufacturer of this system.
UUID Number	Universally Unique Identifier (UUID) is an identifier standard used in software construction, standardized by the Open Software Foundation (OSF) as part of the Distributed Computing Environment (DCE).

# Main

The Main screen allows the user to set the system time and date as well as enable and disable boot option and recovery.

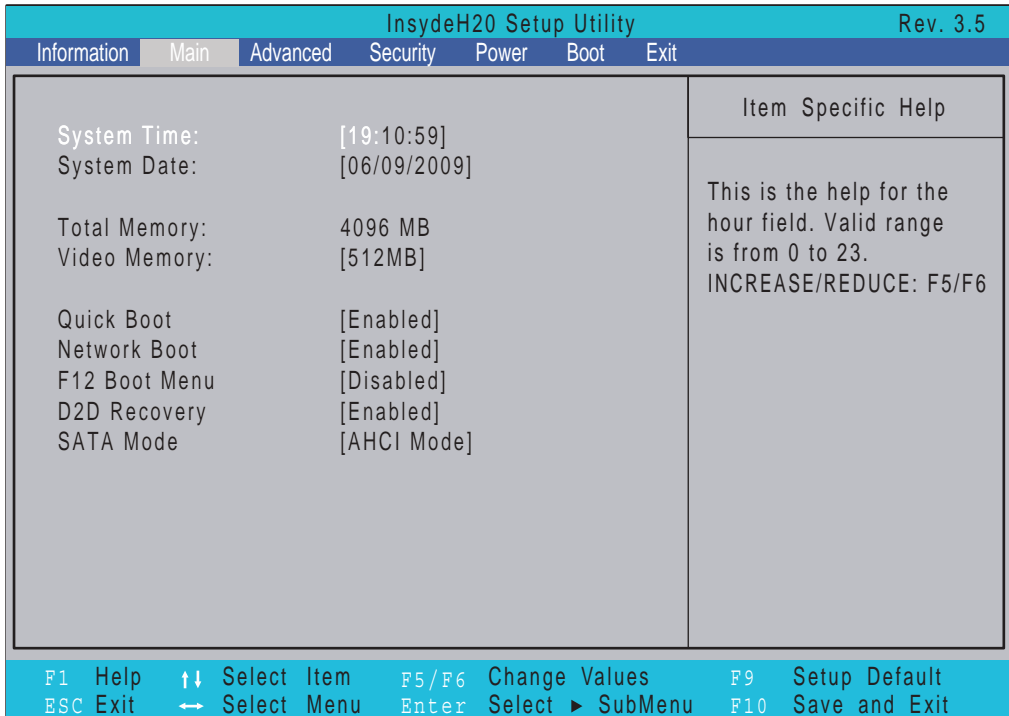

**NOTE:** The screen above is for your reference only. Actual values may differ.

The table below describes the parameters in this screen. Settings in **boldface** are the default and suggested parameter settings.

Parameter	Description	Format/Option
System Time	Sets the system time. The hours are displayed with 24-hour format.	Format: HH:MM:SS (hour:minute:second)
System Date	Sets the system date.	Format MM/DD/YYYY (month/day/year)
Total Memory	This field reports the memory size of the system. Memory size is fixed to 3017 MB.	N/A
Video Memory	Shows the video memory size. VGA Memory size=32 MB	N/A
Quick Boot	Allows startup to skip certain tests while booting, decreasing the time needed to boot the system.	Option: <b>Enabled</b> or Disabled
Network Boot	Enables, disables the system boot from LAN (remote server).	Option: <b>Enabled</b> or Disabled
F12 Boot Menu	Enables, disables Boot Menu during POST.	Option: <b>Enabled</b> or Enabled
D2D Recovery	Enables, disables D2D Recovery function. The function allows the user to create a hidden partition on hard disc drive to store operation system and restore the system to factory defaults.	Option: <b>Enabled</b> or Disabled
SATA Mode	Control the mode in which the SATA controller should operate.	Option: <b>AHCI</b> or IDE

# Advanced

The Advanced screen allows the user to configure the various advanced BIOS options.

**IMPORTANT:** Making incorrect settings to items on these pages may cause the system to malfunction. Unless you have experience adjusting these items, we recommend that you leave these settings at the default values. If making settings to items on these pages causes your system to malfunction or prevents the system from booting, open BIOS and choose Load Optimal Defaults in the Exit menu to boot up normally.

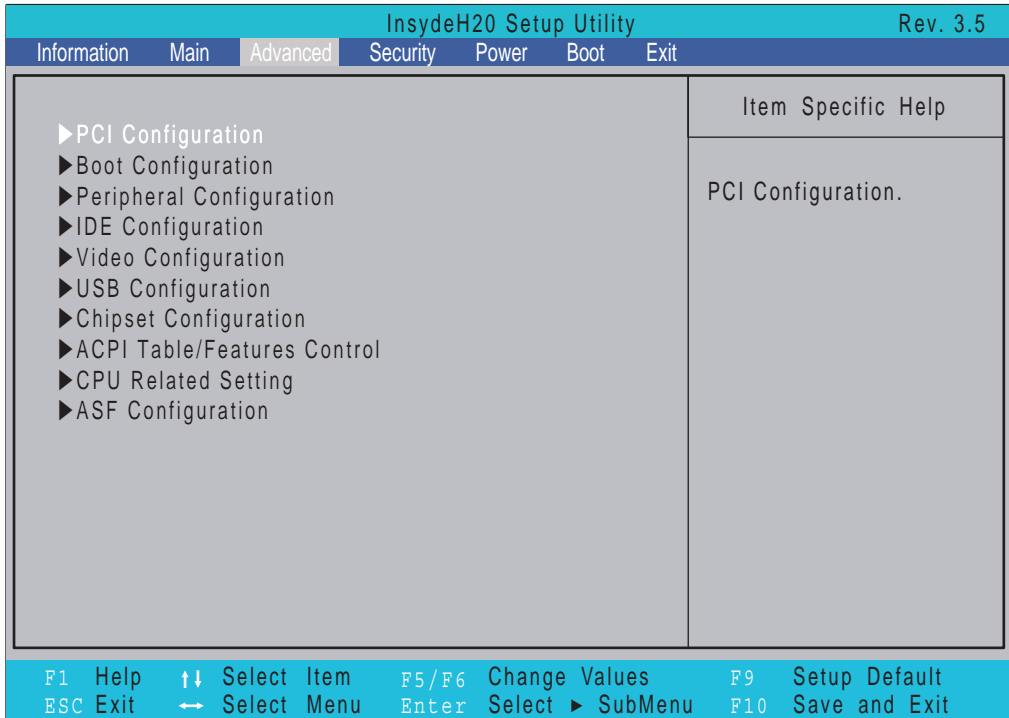

The table below describes the items, menus, and submenus in this screen. Settings in **boldface** are the default and suggested parameter settings.

Parameter	Description	Submenu Items
PCI Configuration	Enter the PCI Configuration menu	<ul style="list-style-type: none"> <li>• PCI Slot 4 IRQ Priority</li> <li>• PCI Slot 5 IRQ Priority</li> <li>• PCI Slot 6 IRQ Priority</li> </ul> <p>Manual IRQ selection does not guarantee a PCI slot device will be configured as chosen; PnP ISA cards are assigned resources first.</p>
Boot Configuration	Enter the Boot Configuration menu.	<ul style="list-style-type: none"> <li>• Numlock</li> </ul>

Parameter	Description	Submenu Items
Peripheral Configuration	Enter the Peripheral Configuration menu.	<ul style="list-style-type: none"> <li>Peripheral Configuration: <ul style="list-style-type: none"> <li>Serial Port A</li> <li>Serial Port B</li> <li>Parallel Port</li> </ul> </li> <li>SB On-chip Device Configuration <ul style="list-style-type: none"> <li>OHCI0</li> <li>OHCI1</li> <li>OHCI2</li> <li>OHCI3</li> <li>OHCI4</li> <li>EHCI0</li> <li>EHCI1</li> <li>SATA</li> <li>Azalia</li> </ul> </li> </ul>
IDE Configuration	Enter the IDE Configuration menu.	<ul style="list-style-type: none"> <li>IDE Controller</li> <li>HDC Configure as</li> <li>Primary IDE Cable Type</li> <li>Serial ATA Port (0-5)</li> <li>Channel 4 Master and Slave</li> </ul>
Video Configuration	Enter the Video Configuration menu.	<ul style="list-style-type: none"> <li>Primary Video Adaptor</li> <li>internal Video Mode</li> <li>UMA Sharing memory size</li> <li>Special features</li> <li>IGD—Boot Type</li> </ul>
USB Configuration	Enter the USB Configuration menu.	<ul style="list-style-type: none"> <li>USB 2.0</li> <li>USB Legacy</li> </ul>
Chipset Configuration	Enter the Chipset Configuration menu.	<ul style="list-style-type: none"> <li>PCI Express Configurations</li> <li>GPP Slots Power Limit, W</li> <li>Port 2-10 Features: <ul style="list-style-type: none"> <li>Gen2 High Speed Mode</li> <li>Link ASPM</li> <li>Link Width</li> <li>Slots Power Limit, W</li> <li>L1 Immediate ACK</li> <li>Compliance Mode</li> </ul> </li> </ul>
ACPI Table/Features Control	Enter the ACPI Table/Features Control menu.	<ul style="list-style-type: none"> <li>FACP—C2 Latency Value</li> <li>FACP—C3 Latency Value</li> <li>FACP—RTC S4 Wakeup</li> <li>APIC—IO APIC Mode</li> <li>HPET—HPET Support</li> <li>_OSC Method</li> </ul>
CPU Related Setting	Enter the CPU Related Setting menu.	<ul style="list-style-type: none"> <li>Memory Clock Control</li> <li>HT Frequency Control</li> <li>HT Width Control</li> <li>CPU P-State Setting</li> </ul>
ASF Configuration	Enter the ASF Configuration menu	<ul style="list-style-type: none"> <li>Mini WatchDog Timeout</li> <li>Power-On Wait Time</li> </ul>

# Security

The Security screen contains parameters that help safeguard and protect your computer from unauthorized use.

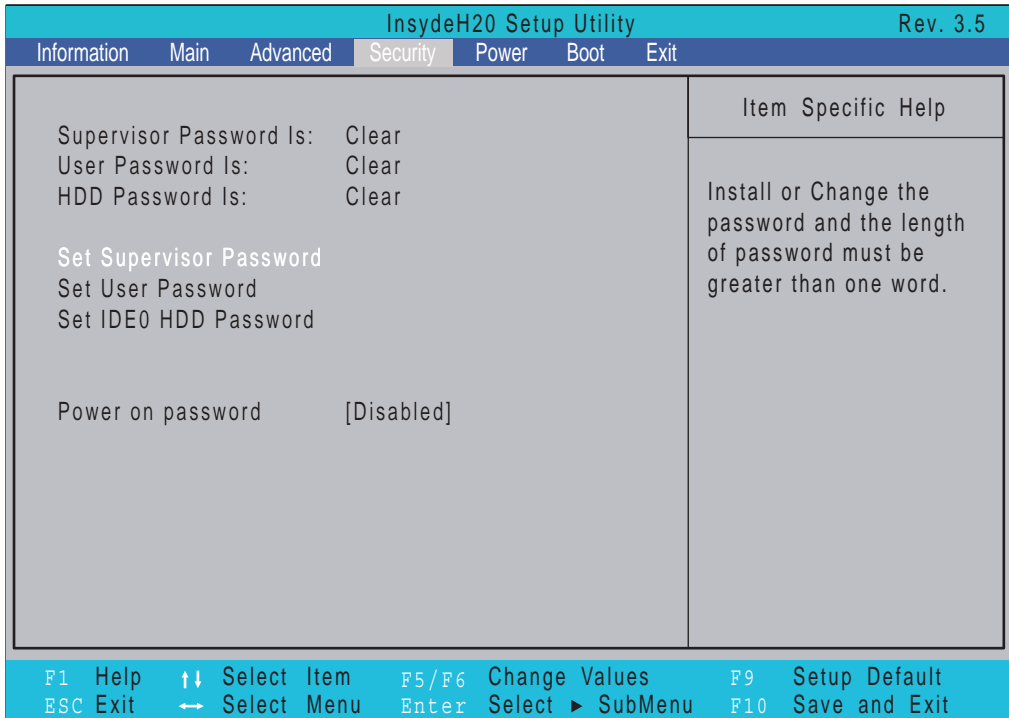

The table below describes the parameters in this screen. Settings in **boldface** are the default and suggested parameter settings.

Parameter	Description	Option
Supervisor Password Is	Shows the setting of the Supervisor password	<b>Clear</b> or Set
User Password Is	Shows the setting of the user password.	<b>Clear</b> or Set
Set Supervisor Password	Press Enter to set the supervisor password. When set, this password protects the BIOS Setup Utility from unauthorized access. The user can not either enter the Setup menu nor change the value of parameters.	
Set User Password	Press Enter to set the user password. When user password is set, this password protects the BIOS Setup Utility from unauthorized access. The user can enter Setup menu only and does not have right to change the value of parameters.	
Set Hdd Password	Enter HDD password.	
Power on password	Defines whether a password is required or not while the events defined in this group happened. The following sub-options are all requires the Supervisor password for changes and should be grayed out if the user password was used to enter setup.	<b>Enabled</b> or Disabled

**NOTE:** When you are prompted to enter a password, you have three tries before the system halts. Don't forget your password. If you forget your password, you may have to return your notebook computer to your dealer to reset it.

---

## Setting a Password

Follow these steps as you set the user or the supervisor password:

1. Use the ↑ and ↓ keys to highlight the Set Supervisor Password parameter and press the **Enter** key. The Set Supervisor Password box appears:

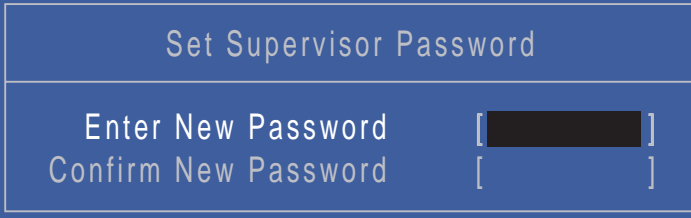

The screenshot shows a blue BIOS screen titled "Set Supervisor Password". Below the title, there are two input fields: "Enter New Password" and "Confirm New Password". The "Enter New Password" field contains a blacked-out password, and the "Confirm New Password" field is empty.

2. Type a password in the "Enter New Password" field. The password length can not exceed 8 alphanumeric characters (A-Z, a-z, 0-9, not case sensitive). Retype the password in the "Confirm New Password" field.

**IMPORTANT:** Be very careful when typing your password because the characters do not appear on the screen.

3. Press **Enter**. After setting the password, the computer sets the User Password parameter to "Set".
4. If desired, you can opt to enable the Password on boot parameter.
5. When you are done, press F10 to save the changes and exit the BIOS Setup Utility.

## Removing a Password

Follow these steps:

1. Use the ↑ and ↓ keys to highlight the Set Supervisor Password parameter and press the **Enter** key. The Set Password box appears:



The screenshot shows a blue BIOS screen titled "Set Supervisor Password". Below the title, there are three input fields: "Enter Current Password", "Enter New Password", and "Confirm New Password". The "Enter Current Password" field contains a blacked-out password, while the other two fields are empty.

2. Type the current password in the Enter Current Password field and press **Enter**.
3. Press **Enter** twice **without** typing anything in the Enter New Password and Confirm New Password fields. The computer then sets the Supervisor Password parameter to "Clear".
4. When you have changed the settings, press u to save the changes and exit the BIOS Setup Utility.

---

## Changing a Password

1. Use the ↑ and ↓ keys to highlight the Set Supervisor Password parameter and press the **Enter** key. The Set Password box appears.

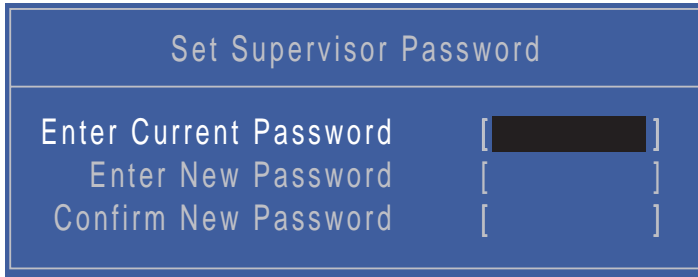

The screenshot shows a blue BIOS screen titled "Set Supervisor Password". It contains three input fields: "Enter Current Password", "Enter New Password", and "Confirm New Password". The "Enter Current Password" field is filled with blacked-out characters, while the other two fields are empty.

2. Type the current password in the Enter Current Password field and press **Enter**.
3. Type a password in the Enter New Password field. Retype the password in the Confirm New Password field.
4. Press **Enter**. After setting the password, the computer sets the User Password parameter to "Set".
5. If desired, you can enable the Password on boot parameter.
6. When you are done, press **F10** to save the changes and exit the BIOS Setup Utility.

If the verification is OK, the screen will display as following.

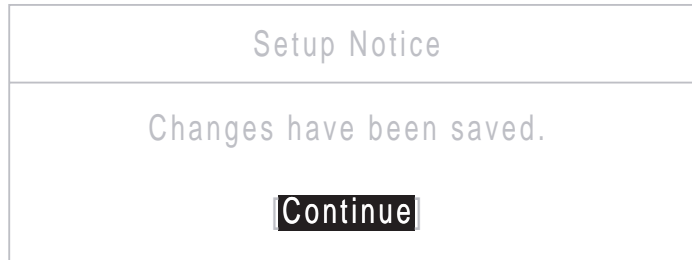

The screenshot shows a white BIOS screen titled "Setup Notice". The text "Changes have been saved." is displayed in the center. At the bottom, there is a black button labeled "Continue".

The password setting is complete after the user presses **Enter**.

If the current password entered does not match the actual current password, the screen will show you the Setup Warning.



The screenshot shows a white BIOS screen titled "Setup Warning" in red text. Below the title, the text "Invalid Password." is displayed in red. At the bottom, there is a black button labeled "Continue".

If the new password and confirm new password strings do not match, the screen displays the following message.



The screenshot shows a white BIOS screen titled "Setup Warning" in red text. Below the title, the text "Passwords do not match. Re-enter password." is displayed in red. At the bottom, there is a black button labeled "Continue".



# Power

The Power screen allows the user to configure CPU and power management options.

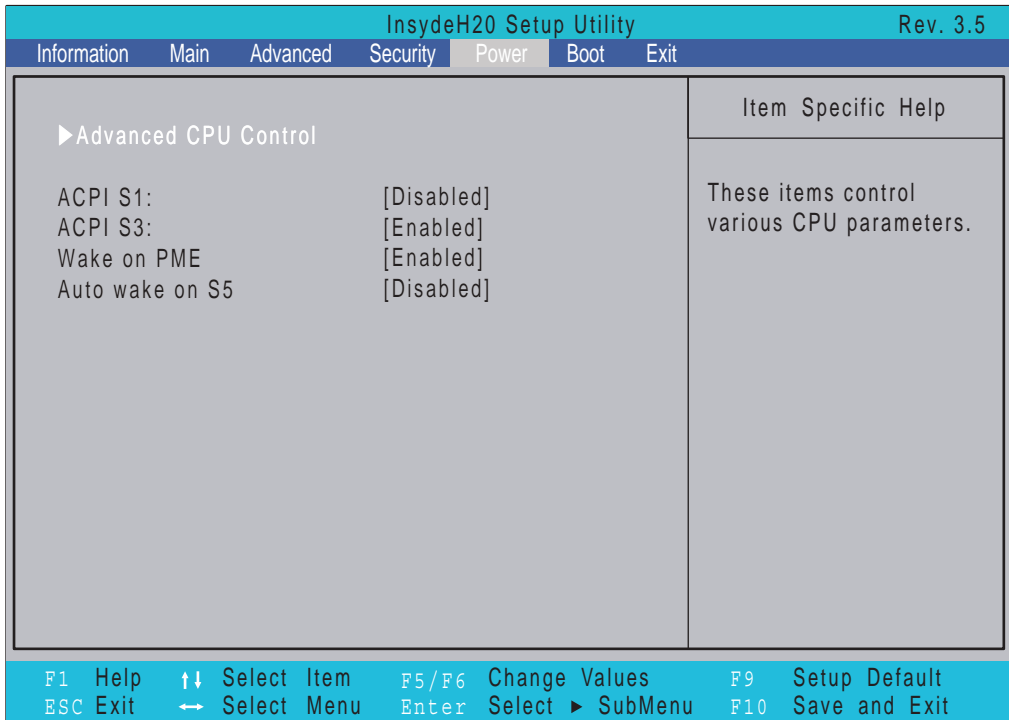

The table below describes the parameters in this screen. Settings in **boldface** are the default and suggested parameter settings.

Parameter	Description	Submenu Items
Advanced CPU Control	Enter the Advanced CPU Control menu.	<ul style="list-style-type: none"> <li>• IST Configuration</li> <li>• Thermal Mode</li> <li>• CMP Support</li> <li>• Use NX capability</li> <li>• C-State support</li> <li>• Enhanced C-States Enable</li> <li>• Pop Up Support</li> <li>• Pop Down Support</li> <li>• Hard C4E</li> <li>• Bi-directional PROCHOT#</li> <li>• ACPI 3.0 T-States</li> <li>• DTS Enable</li> <li>• Thermal Trip Points Setting (Throttle On Temp.)</li> </ul>
ACPI S3	<b>Enable</b> or Disable ACPI S1/S3 Sleep State.	N/A
ACPI S3	<b>Enable</b> or Disable ACPI S1/S3 Sleep State.	N/A
Wake on PME	<b>Disable</b> or Enable wake up when the system power is off and a PCI Power Management Enable wake up event occurs.	N/A
Auto wake on S5	<b>Disable</b> or Enable auto wake up by date and time or at a fixed time everyday.	N/A

# Boot

This menu allows the user to decide the order of boot devices to load the operating system. Bootable devices includes the USB diskette drives, the onboard hard disk drive and the DVD drive in the module bay.

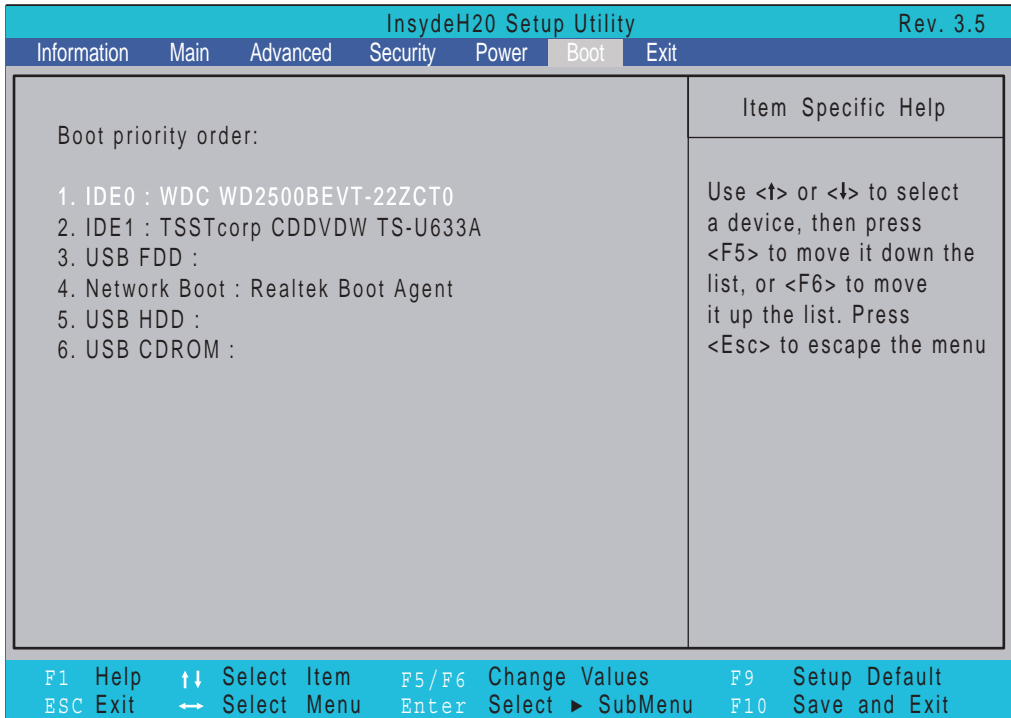

# Exit

The Exit screen allows you to save or discard any changes you made and quit the BIOS Utility.

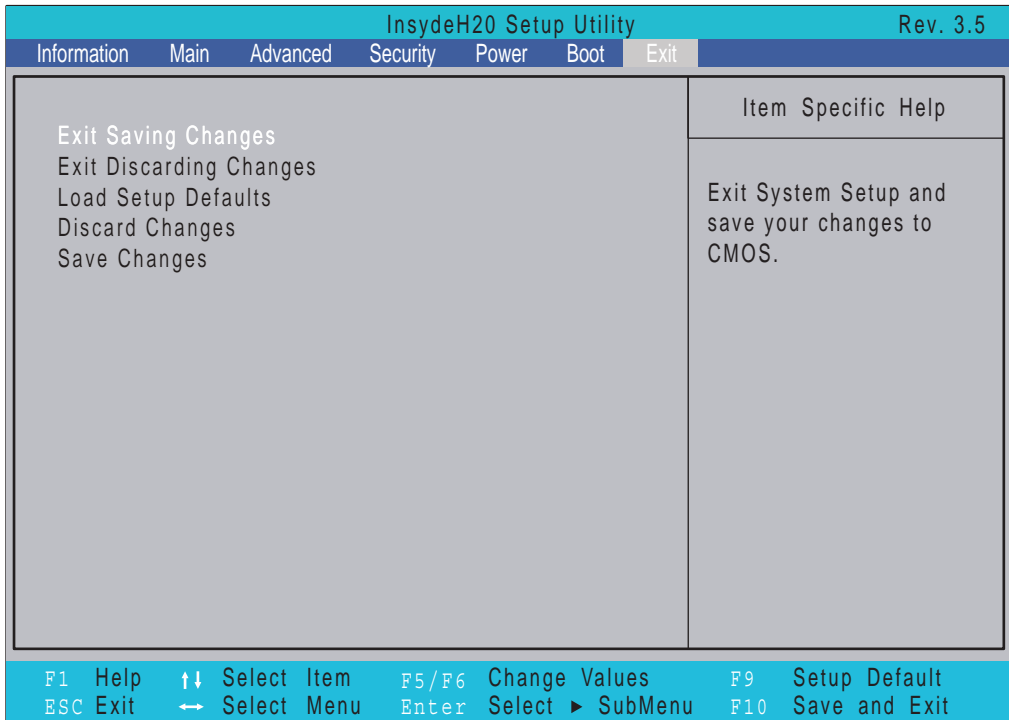

The table below describes the parameters in this screen.

Parameter	Description
Exit Saving Changes	Exit System Setup and save your changes to CMOS.
Exit Discarding Changes	Exit utility without saving setup data to CMOS.
Load Setup Default	Load default values for all SETUP item.
Discard Changes	Load previous values from CMOS for all SETUP items.
Save Changes	Save Setup Data to CMOS.

---

# BIOS Flash Utility

The BIOS flash memory update is required for the following conditions:

- New versions of system programs
- New features or options
- Restore a BIOS when it becomes corrupted.

# DOS Flash Utility

Perform the following steps to use the DOS Flash Utility:

1. Press F2 during boot to enter the Setup Menu.
2. Select **Boot Menu** to modify the boot priority order, for example, if using USB HDD to Update BIOS, move USB HDD to position 1.

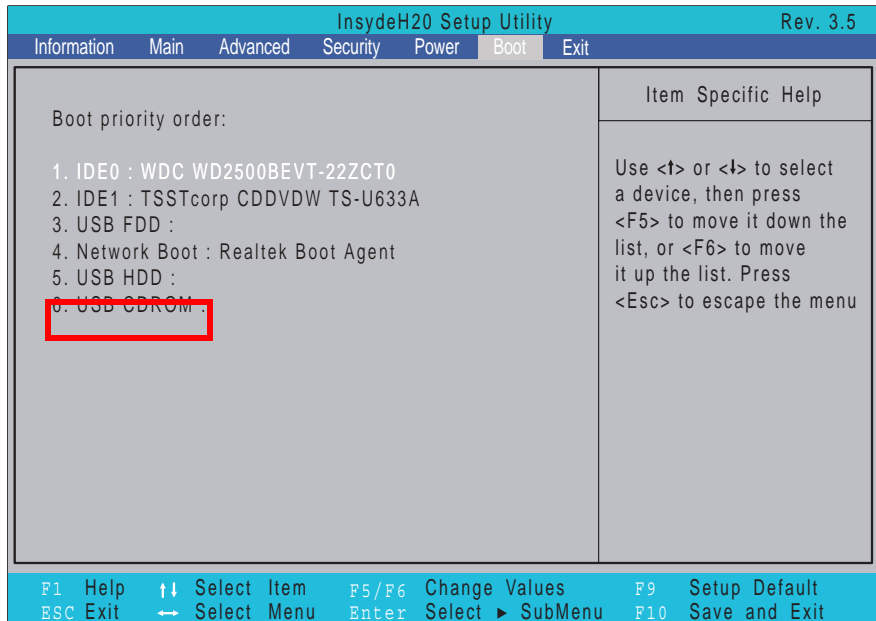

3. Execute the **FLASH.BAT** batch file to update BIOS.

The flash process begins as shown.



4. In flash BIOS, the message **Please do not remove AC Power Source** displays.

**NOTE:** If the AC power is not connected, the following message displays.



Plug in the AC power to continue.

5. Flash is complete when the message Flash programming complete displays.

---

# WinFlash Utility

Perform the following steps to use the WinFlash Utility:

1. Double click the WinFlash executable.
2. Click **OK** to begin the update. A progress screen displays.

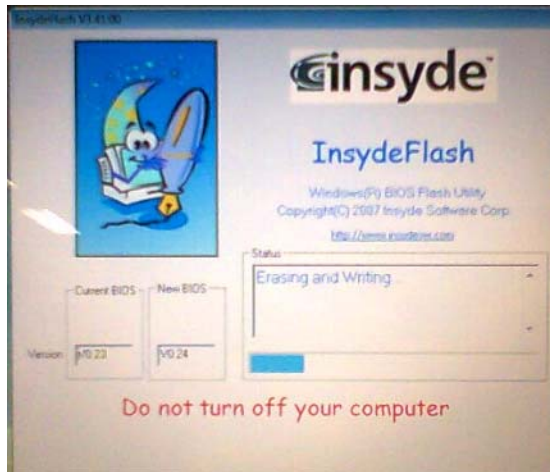

3. When the process is complete, close all programs and applications and reboot the system.

---

# Remove HDD/BIOS Password Utilities

This section provide you with removing HDD/BIOS method:

## Remove HDD Password:

When the user keys in the wrong password three times, the system reports the following error code to user.

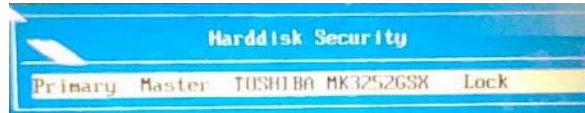

To unlock the HDD password, perform the following steps:

1. Press **Enter** to display the Select Item screen.

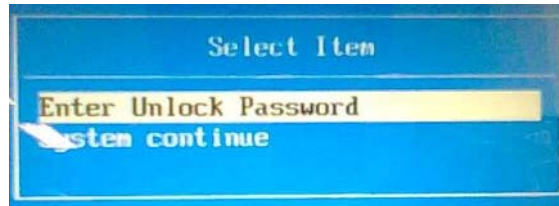

2. Select **Enter Unlock Password** and press **Enter**.

An Unlock Password displays.



3. Make a note of the key, **76943488** in the example.
4. Boot up the system to a removable bootable drive containing DOS and the UnlockHD.EXE program and open a DOS prompt. For instructions on changing boot priority see "Boot" on page 32.
5. Enter the **UnlockHD.EXE** command and input the key to create an unlock code. Make a note of the result, for example **46548274**.
6. Reboot to the hard disk and wait for the error code to reappear.
7. Press **Enter** to display the Select Item screen.
8. Select **Enter Unlock Password** and press **Enter**.
9. Enter the unlock code generated by UnlockHD.EXE.
10. Save and exit the BIOS to complete the process.

---

## Removing BIOS Passwords:

If you key in the wrong Supervisor Password three times, System Disabled displays on the screen. See the image below.

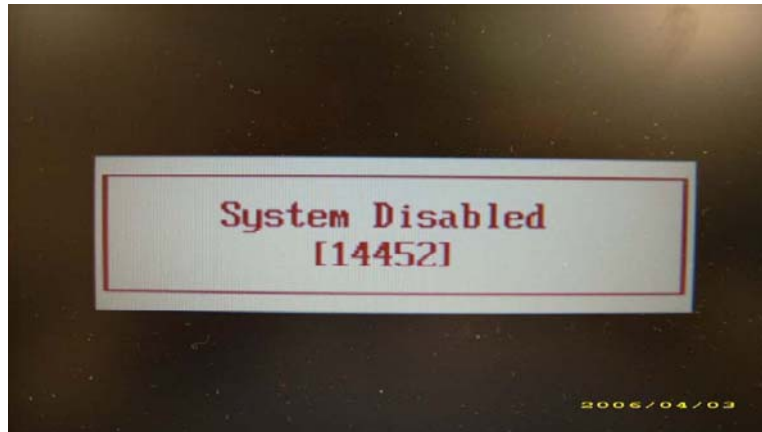

To reset the BIOS password, run clnpwd.exe as follows:

1. From a DOS prompt, Execute **clnpwd.exe**

```
d:\Clnpwd>clnpwd
ACER Clean Password Utility V1.00
Press 1 or 2 to clean any password shown as below
  1.User Password
  2.Supervisor Password

Clean User Password Successfully!
```

2. Press 1 or 2 to clean the desired password shown on the screen.

The on-screen message determines whether the function is successful or not.



---

# Miscellaneous Utilities

## Using Boot Sequence Selector

Boot Sequence Selector allows the boot order to be changes without accessing the BIOS. To use Boot Sequence Selector, perform the following steps:

1. Enter into DOS.
2. Execute BS.exe to display the usage screen.

```
d:\B00TSEQ>bs
*** Boot Sequence Selector Version 0.03 ***
Create by Rockwell Chuang 10/01/2005.
Usage:
      BS [ 1 | 2 | 3 | 4 ]
BS 1 : [ Floppy ] => [HardDisk] => [ CD-ROM ] => [ LAN   ]
BS 2 : [HardDisk] => [ CD-ROM ] => [ LAN   ] => [ Floppy ]
BS 3 : [ CD-ROM ] => [HardDisk] => [ LAN   ] => [ Floppy ]
BS 4 : [ LAN   ] => [ Floppy ] => [HardDisk] => [ CD-ROM ]
d:\B00TSEQ>
```

3. Select the desired boot sequence by entering the corresponding sequence, for example, enter BS2 to change the boot sequence to HDD|CD ROM|LAN|Floppy.

## Using DMITools

The DMI (Desktop Management Interface) Tool copies BIOS information to eeprom to be used in the DMI pool for hardware management.

When the BIOS displays **Verifying DMI pool data** it is checking the table correlates with the hardware before sending to the operating system (Windows, etc.).

To update the DMI Pool, perform the following steps:

1. Enter into DOS.
2. Execute **dmitools.exe**. The following messages show dmitools usage:

```
*** Compal DMI String R/W Utility Ver1.40 for 2006/03/14 ***

Usage:

DMITOOLS [ /R | /WP | /WS | /WU ] [ STRING ]

[R]   : Read DMI Information from Memory
[WM]  : Write Manufacturer Name to EEPROM. (Max.= 16 characters)
[WP]  : Write Product Name to EEPROM.      (Max.= 16 characters)
[WS]  : Write Serial Number to EEPROM     (Max.= 22 characters)
[WU]  : Write UUID to EEPROM.             (Ignore String   )
[WA]  : Write Asset Tag to EEPROM.        (Max.= 32 characters)
```

**IMPORTANT:**The following write examples (2 to 5) require a system reboot to take effect

---

### Example 1: Read DMI Information from Memory

Input:

```
dmitools /r
```

Output:

```
Manufacturer (Type1, Offset04h): Acer  
Product Name (Type1, Offset05h): Aspire 5538 xxxxx  
Serial Number (Type1, Offset07h): 01234567890123456789  
UUID String (Type1, Offset08h): xxxxxxxx-xxxx-xxxx-xxxx-xxxxxxxxxxxx  
Asset Tag (Type3, Offset04h): Acer Asstag
```

### Example 2: Write Product Name to EEPROM

Input:

```
dmitools /wp Acer
```

### Example 3: Write Serial Number to EEPROM

Input:

```
dmitools /ws 01234567890123456789
```

### Example 4: Write UUID to EEPROM

Input:

```
dmitools /wu
```

### Example 5: Write Asset Tag to EEPROM

Input:

```
dmitools /wa Acer Asstag
```

## Using the LAN MAC Utility

Perform the following steps to write MAC information to eeprom:

1. Use a text editor, for example Notepad, to edit the MAC.CFG file as shown:

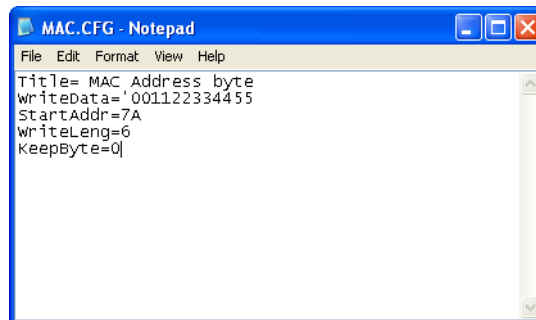

- WriteData= '001122334455' <----- MAC value
  - StartAddr=7A <----- MAC address
  - WriteLeng=6 <----- MAC value length
  - KeepByte=0 <----- can be any value
2. Boot into DOS.
  3. Execute **MAC.BAT** to write MAC information to eeprom.



# Machine Disassembly and Replacement

---

This chapter contains step-by-step procedures on how to disassemble the notebook computer for maintenance and troubleshooting.

## Disassembly Requirements

To disassemble the computer, you need the following tools:

- Wrist grounding strap and conductive mat for preventing electrostatic discharge
- Flat screwdriver
- Philips screwdriver
- Plastic flat screwdriver
- Plastic tweezers

**NOTE:** The screws for the different components vary in size. During the disassembly process, group the screws with the corresponding components to avoid mismatch when putting back the components.

## Related Information

The product previews seen in the disassembly procedures may not represent the final product color or configuration.

**IMPORTANT:** Cable paths and positioning may not represent the actual model. During the removal and replacement of components, ensure all available cable channels and clips are used and that the cables are replaced in the same position.

---

# General Information

## Pre-disassembly Instructions

Before proceeding with the disassembly procedure, make sure that you do the following:

1. Turn off the power to the system and all peripherals.
2. Unplug the AC adapter and all power and signal cables from the system.



3. Place the system on a flat, stable surface.
4. Remove the battery pack.

## Disassembly Process

The disassembly process is divided into the following sections:

- External components disassembly
- Main unit disassembly
- LCD module disassembly

The flowcharts provided in the succeeding disassembly sections illustrate the entire disassembly sequence. Observe the order of the sequence to avoid damage to any of the hardware components. For example, if you want to remove the Mainboard, you must first remove the Keyboard, and LCD Module then disassemble the inside assembly frame in that order.

### Main Screw List

Screw	Quantity	Part Number
M2.5*4 (silver)	4	86.PEA02.003
M3*3	4	86.PEA02.008
M2*3 (silver)	10	86.PEA02.002
M2.5*8	18	86.PEA02.006
M2.5*6	13	86.PEA02.007
M2*3 (black)	1	86.PEA02.001
M2.5*3	7	86.PEA02.009
M2.5*6 (spring tension)	4	86.PEA02.004

# External Module Disassembly Process

**NOTE:** The product previews seen in the disassembly procedures may not represent the final product color or configuration.

## External Modules Disassembly Flowchart

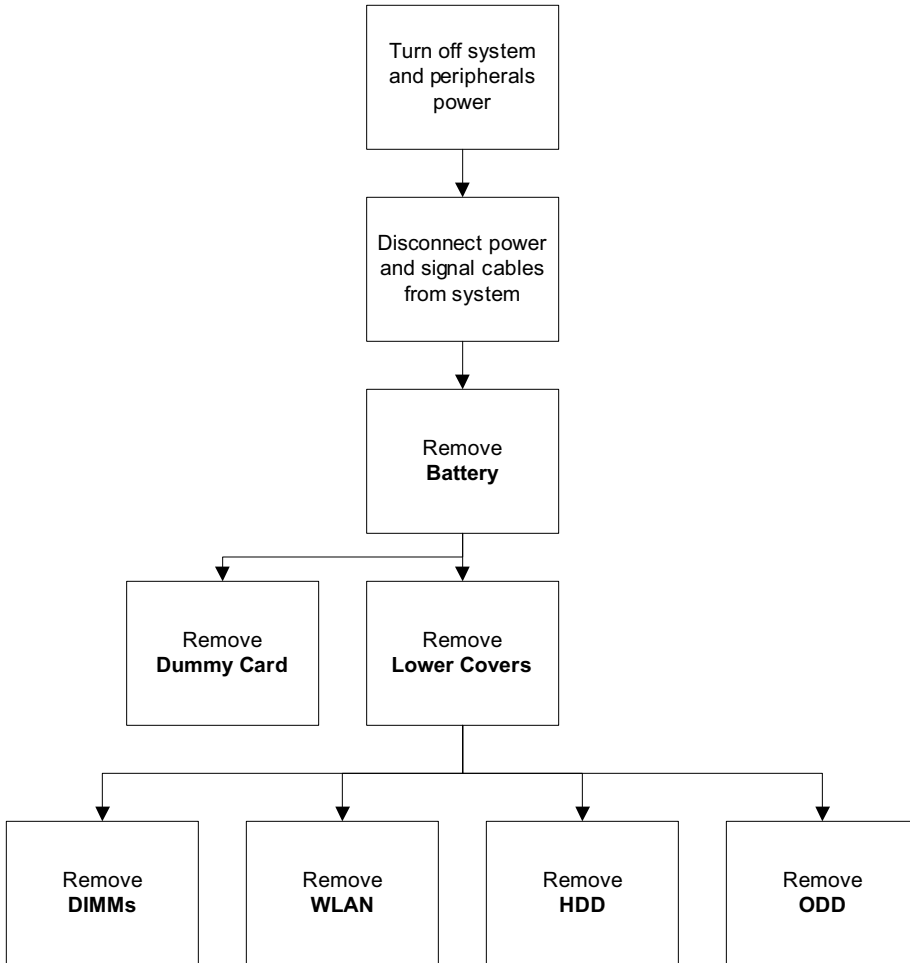

### Screw List

Step	Screw	Quantity	Part No.
HDD Module	M2.5*3	2	86.PEA02.003
HDD Carrier	M3*3	4	86.PEA02.008
WLAN Board	M2*3	1	86.PEA02.001
ODD Module	M2.5*3	1	86.PEA02.009
ODD Bracket	M2*3 (silver)	2	86.PEA02.002

---

## Removing the Battery Pack

1. Turn the computer over.
2. Slide the battery lock/unlock latch to the unlock position.



3. Slide and hold the battery release latch to the release position (1), then slide out the battery pack from the main unit (2).



---

## Removing the Hard Disk Drive Module

1. See “Removing the Battery Pack” on page 45
2. Loosen the two captive screws in the HDD Cover.



3. Lift the HDD cover up using the finger tab to remove. Six tabs hold the door in place.

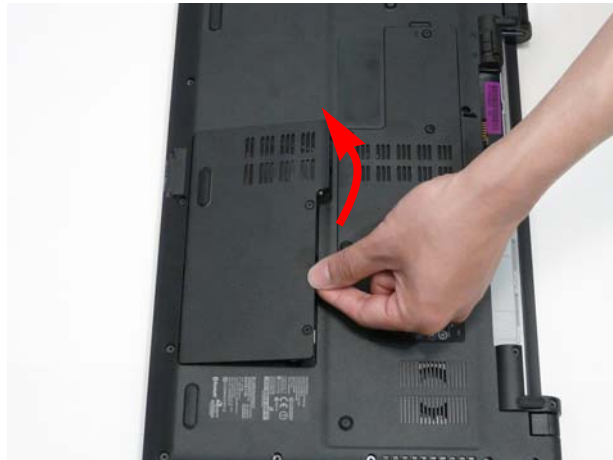



4. Remove the two screws securing the HDD Module in place.



Step	Size	Quantity	Screw Type
HDD Module	M2.5*3	2	

5. Slide the HDD in the direction of the arrow to disconnect the HDD from the interface connector.





- Lift the hard disk drive module out of the bay.

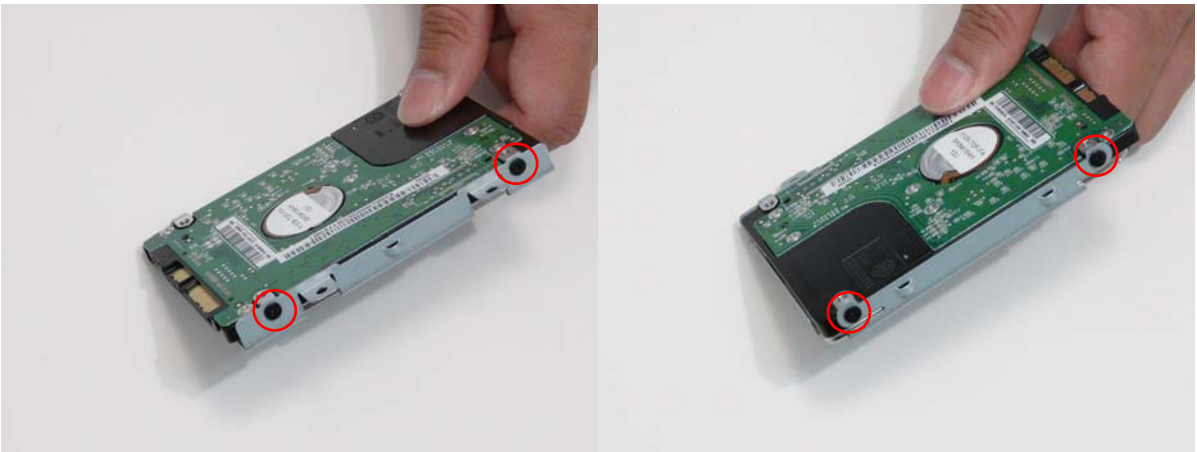

**NOTE:** To prevent damage to device, avoid pressing down on it or placing heavy objects on top of it.

- Remove the four screws (two each side) securing the hard disk to the carrier.



Step	Size	Quantity	Screw Type
HDD Carrier	M3*3	4	

- 
8. Remove the HDD from the carrier.



## Removing the Optical Disk Drive Module

1. See “Removing the Battery Pack” on page 45
2. Loosen the three captive screws in the HDD Cover.



- Lift the HDD cover up using the finger tab to remove. Six tabs hold the door in place.



- Remove the screw securing the ODD module.



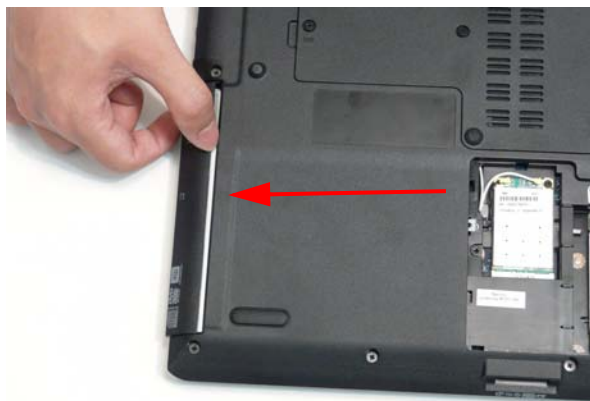

Step	Size	Quantity	Screw Type
ODD Module	M2.5*3	1	

- Slide the ODD module out of the assembly

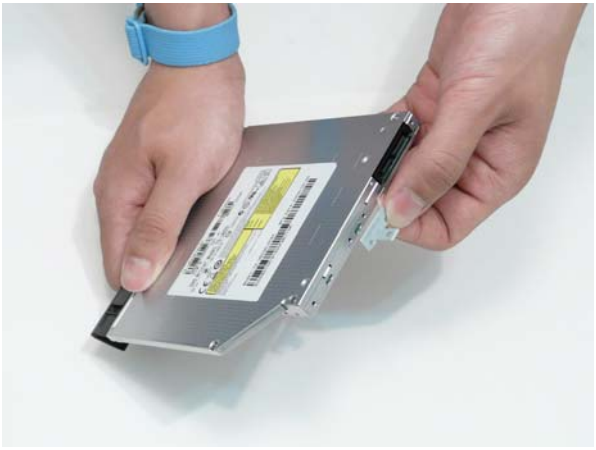

- Remove the screws securing the ODD bracket and remove the ODD bracket from the optical disk drive module.



Step	Size	Quantity	Screw Type
ODD Bracket	M2*3	2	

- Insert an appropriate tool into the manual ODD tray release to open the ODD tray.

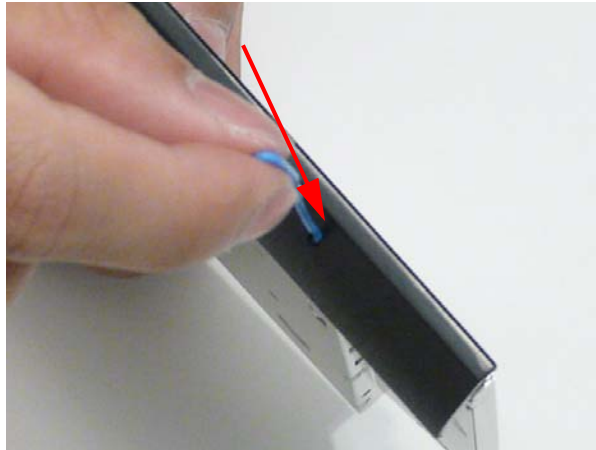

- Press down on the ODD bezel securing clip and pull the bezel out of the ODD.

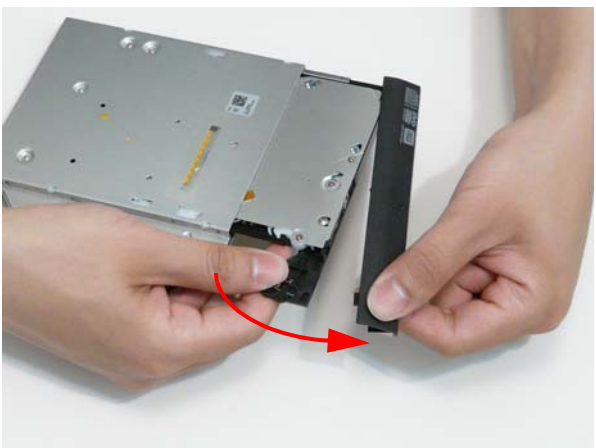
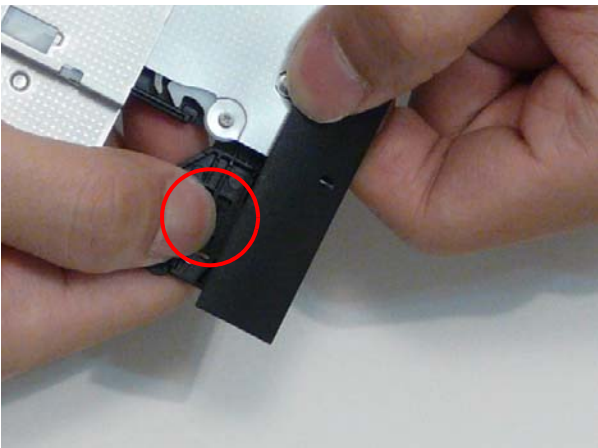



---

## Removing the DIMM Module

1. See “Removing the Battery Pack” on page 45
2. Loosen the two captive screws in the Memory Cover.



3. Lift the Memory Cover up to remove. Pull up using the thumb tab (indicated by the circle below) to release the seven clips securing the cover in place.



4. Identify the SODIMM to remove. The image below shows the locations of SODIMM slot 0 and SODIMM slot 1. Slot 0 must be populated first when installing or replacing defective memory.

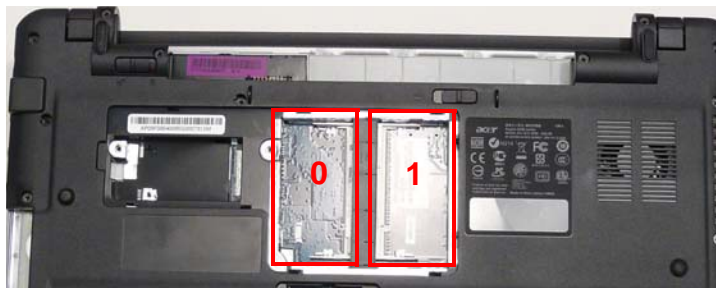

5. Push out the release latches on both sides of SODIMM socket 1 to release the memory module.



6. Remove the DIMM.



7. Push out the release latches on both sides of SODIMM socket 0 to release the DIMM.



---

8. Remove the DIMM.

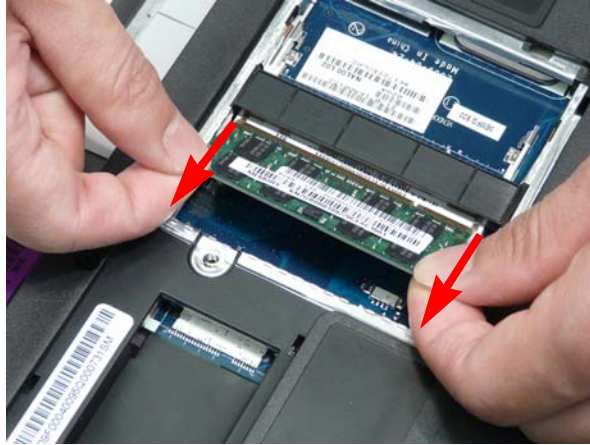



---

## Removing the WLAN Board

1. See "Removing the Battery Pack" on page 45.
2. Loosen the two captive screws in the HDD Cover.



3. Lift the HDD cover up to remove. Use the finger tab to release the six clips securing the cover in place.  
**NOTE:** The HDD is also located under this cover.



4. Disconnect the Antenna cables from the WLAN Board.

**NOTE:** Cable placement is White to the AUX terminal (right) and Black to the MAIN terminal (left).



5. Remove the single screw securing the WLAN Board in place.



Step	Size	Quantity	Screw Type
WLAN Board	M2*3	1	

---

6. Remove the WLAN Board from the Mainboard.



# Main Unit Disassembly Process

**IMPORTANT:** Cable paths and positioning may not represent the actual model. During the removal and replacement of components, ensure all available cable channels and clips are used and that the cables are replaced in the same position.

**NOTE:** The product previews seen in the disassembly procedures may not represent the final product color or configuration.

## Main Unit Disassembly Flowchart

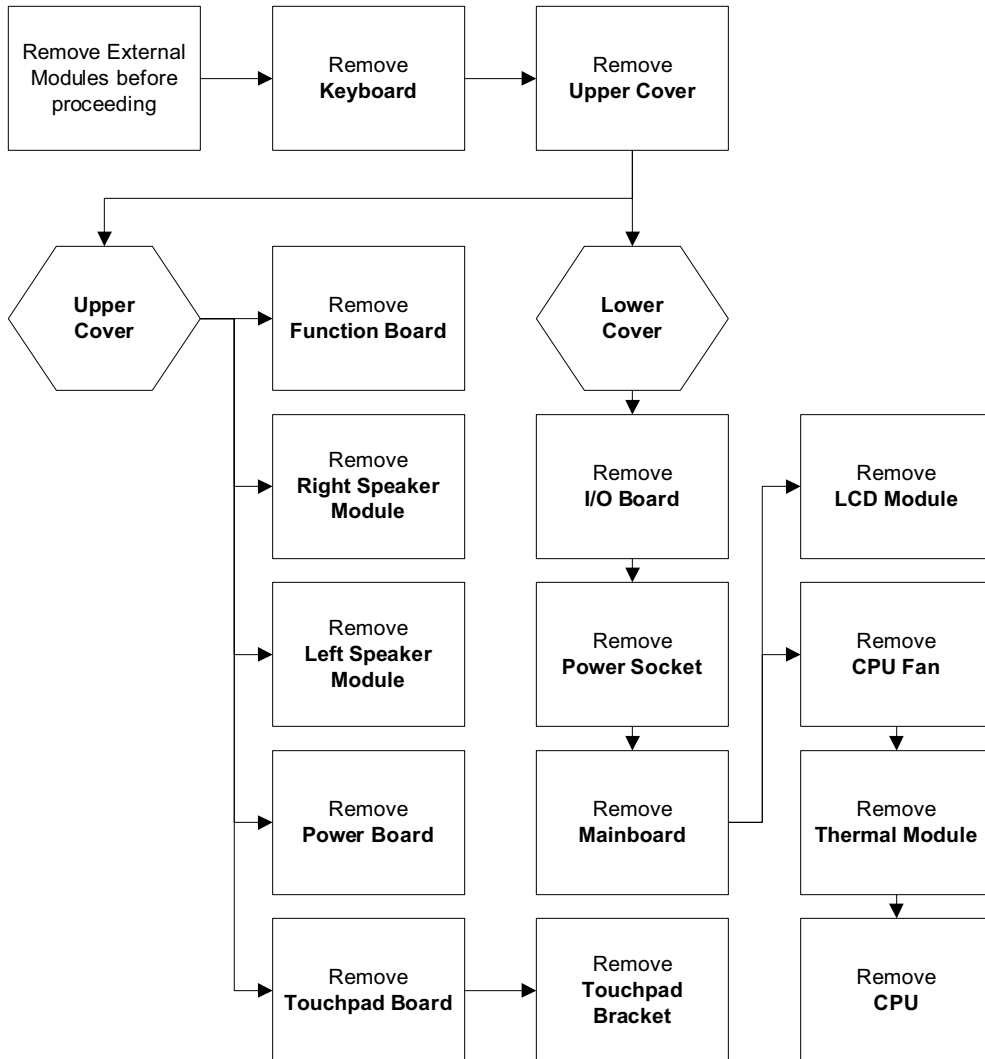

### Screw List

Step	Screw	Quantity	Part No.
Upper Cover	M2.5*8	18	86.PEA02.006
Upper Cover	M2.5*6	7	86.PEA02.007
Button Board	M2*3	3	86.PEA02.002
TouchPad Bracket	M2*3	1	86.PEA02.002
Power Board	M2.5*3	1	86.PEA02.001
Speaker Module	M2.5*3	4	86.PEA02.001

---

Step	Screw	Quantity	Part No.
Media Board	M2.5*3	1	86.PEA02.001
I/O Board	M2.5*6	1	86.PEA02.007
Mainboard	M2.5*6	1	86.PEA02.007
Mainboard (Fan)	M2.5*6	1	86.PEA02.007
LCD Module	M2.5*6	3	86.PEA02.007
Fan	M2.5*6	1	86.PEA02.007
Thermal Module	M2.5*6 (spring tension)	4	86.PEA02.004

# Removing the Keyboard

**IMPORTANT:** The keyboard is easily warped or damaged during the removal process. Take care not to use excessive force when removing the keyboard and replace if any damage occurs.

1. See “Removing the Battery Pack” on page 45.
2. Turn the computer rightside up and open the lid to the full extent.
3. Unlock the six securing latches by pressing down with a suitable plastic tool then sliding along the back edge of the keyboard.

**IMPORTANT:** The use of metal tools may damage the outer casing. Use plastic tools where available.

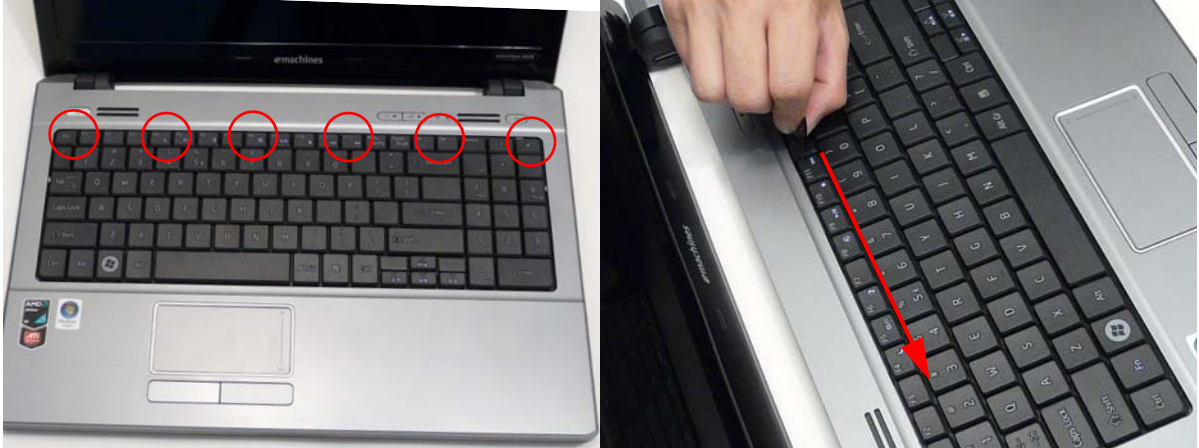

4. Pull up on the center of the keyboard to release the two tabs on each side and lift the Keyboard away from the Upper Cover as shown.

**IMPORTANT:** Do not remove the Keyboard from the Upper Cover; the Keyboard FFC is still attached.



5. Place the keyboard as shown.



6. Open the Keyboard FFC securing latch as shown, then disconnect the FFC and remove the Keyboard.

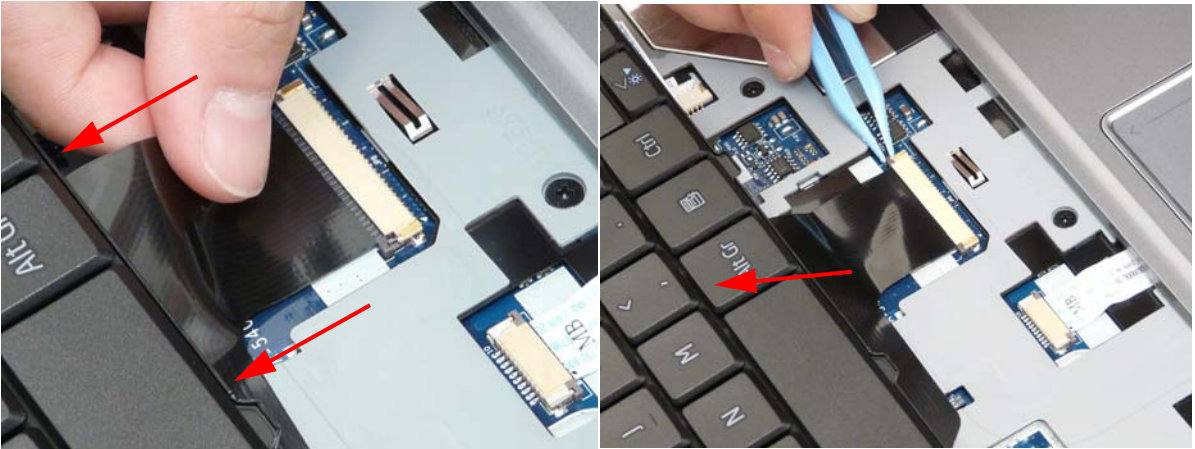



# Removing the Upper Cover

1. Remove all external modules. See “External Modules Disassembly Flowchart” on page 44.
2. Remove the screws securing the Upper Cover to the Lower Cover.

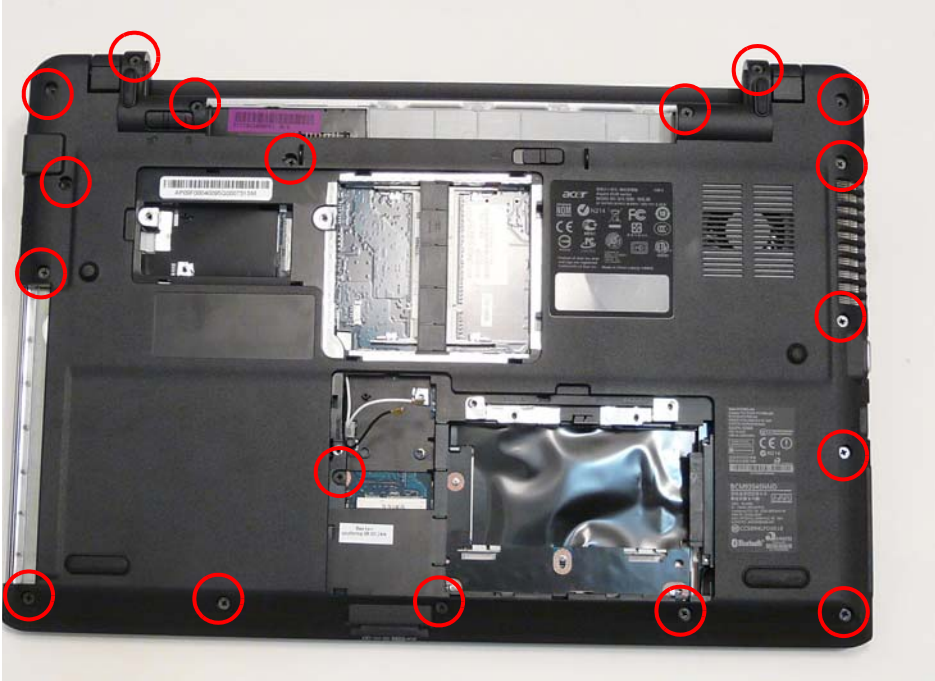

Step	Size	Quantity	Screw Type
Upper Cover	M2.5*8	18	

3. Turn the computer over and disconnect the following cables from the Mainboard:

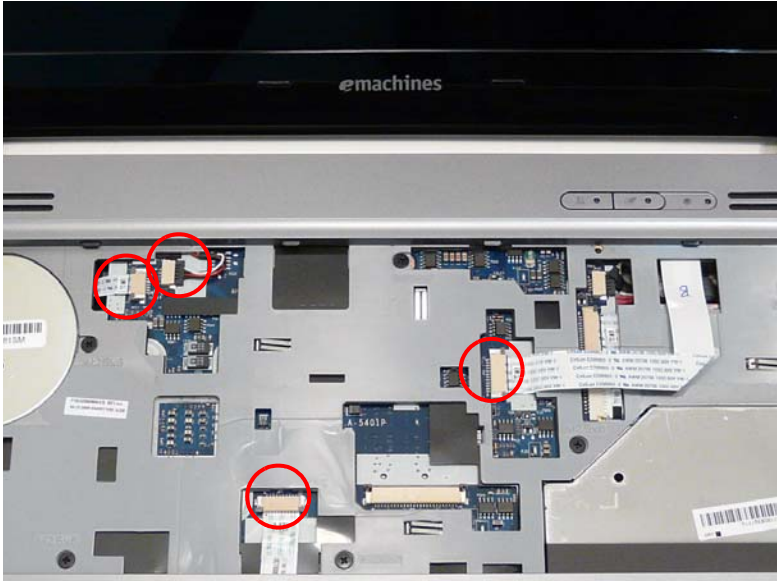



- a. Disconnect the Speaker Cable as shown.



- b. Release the locking latch and disconnect the Power Board FFC as shown.

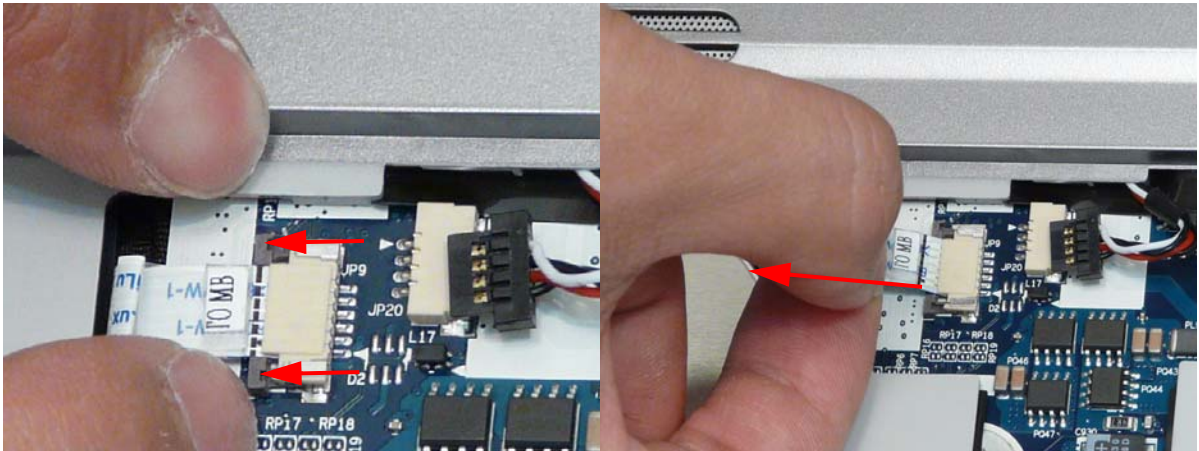

- c. Release the locking latch and disconnect the Button Board FFC as shown.

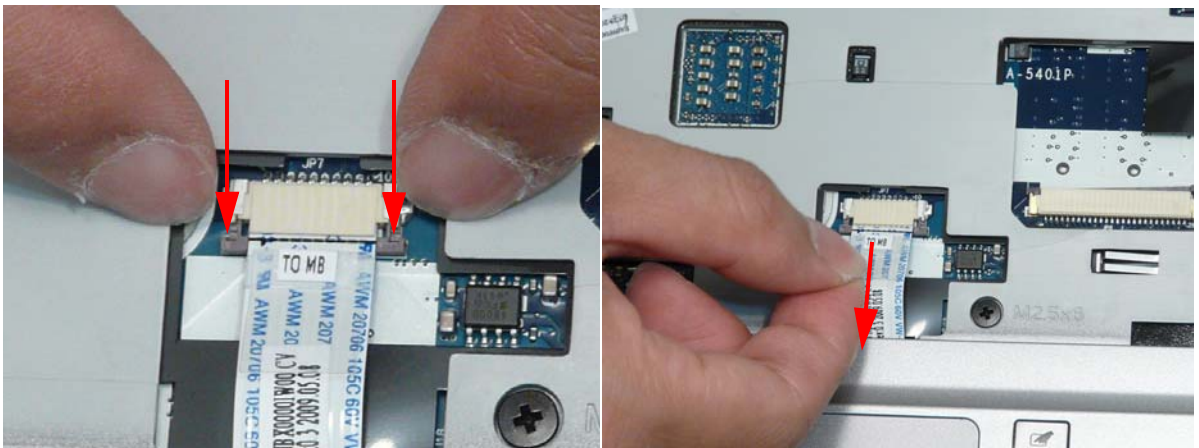

- d. Release the locking latch and disconnect the Media Board FFC as shown.



4. Remove the seven securing screws from the Upper Cover.

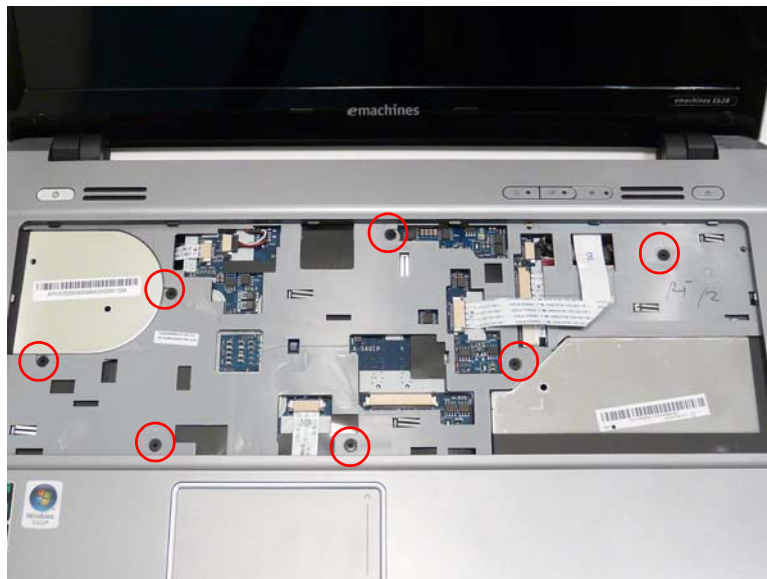

Step	Size	Quantity	Screw Type
Upper Cover	M2.5*6	7	

5. Starting at a top corner, pry apart the Upper and Lower Covers as shown.



6. Working from the back corners toward the back center, pry apart the covers to release the securing hooks on the top edge as shown.



7. Lift the cover away from the assembly.





---

## Removing the Button Board

**IMPORTANT:** The Touchpad Board cannot be removed individually. To replace the Button Board, replace the entire Upper Cover.

1. See “Removing the Upper Cover” on page 62.
2. Remove the mylar sheet covering the Button Board.

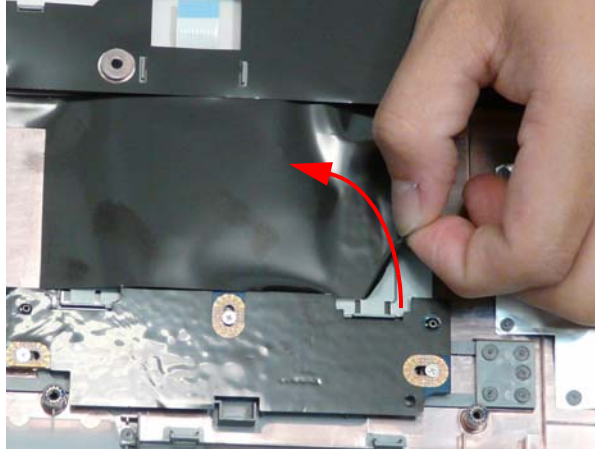

3. Lift the securing latch and disconnect the single FFC connecting the Button Board to the Touchpad.

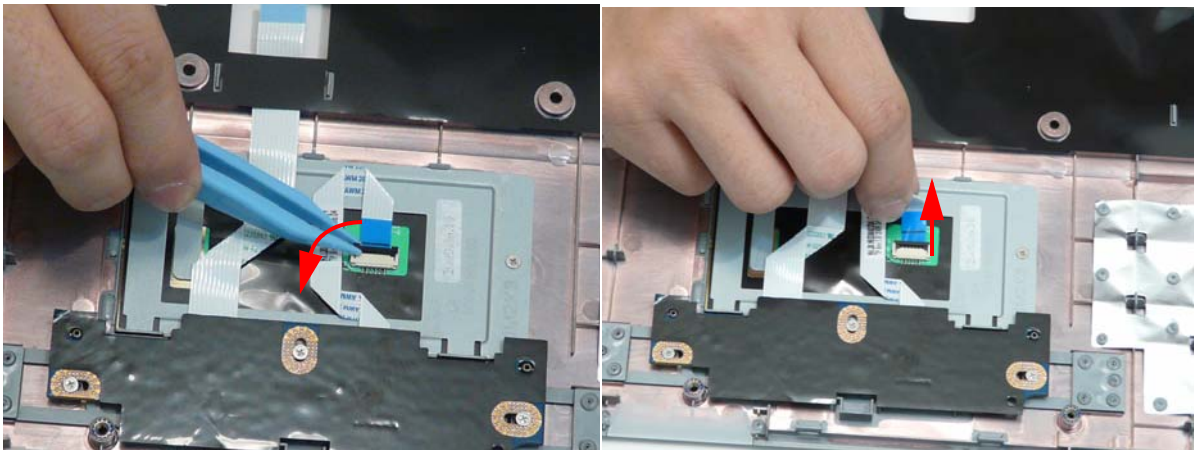

4. Pull the Mainboard FFC through the opening in the upper cover and separate it from the adhesive securing it in place.

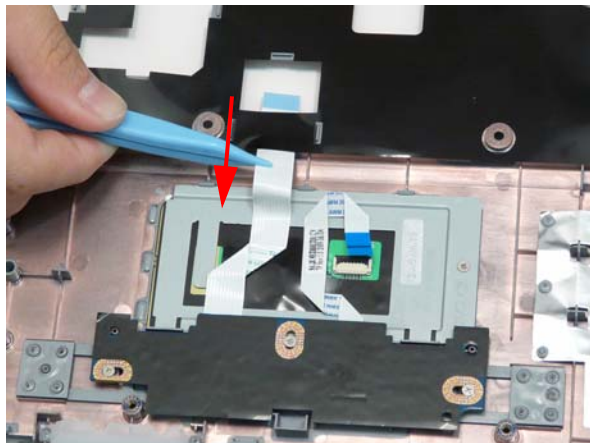

- Detach the button board FFC from the adhesive.

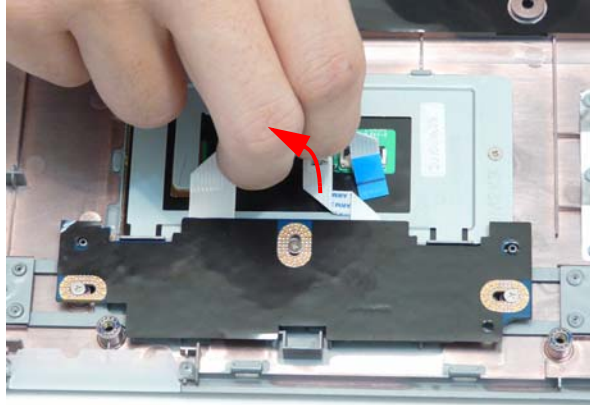

- Remove the three screws securing the button board to the Upper Cover.

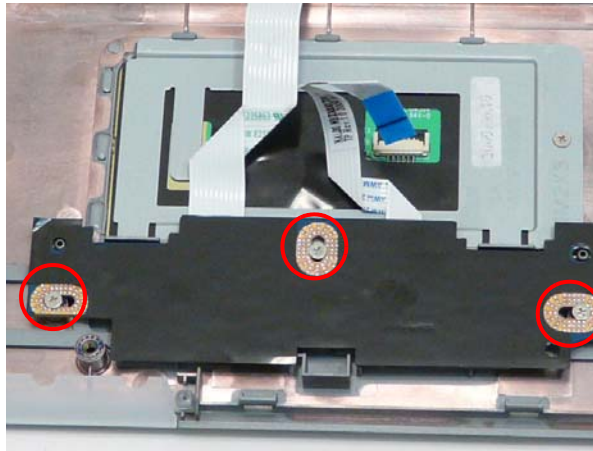

Step	Size	Quantity	Screw Type
Button Board	M2*3	3	

- Pull the Mainboard FFC through the cover as shown.

**IMPORTANT:** Ensure that the FFC is not torn off during removal.

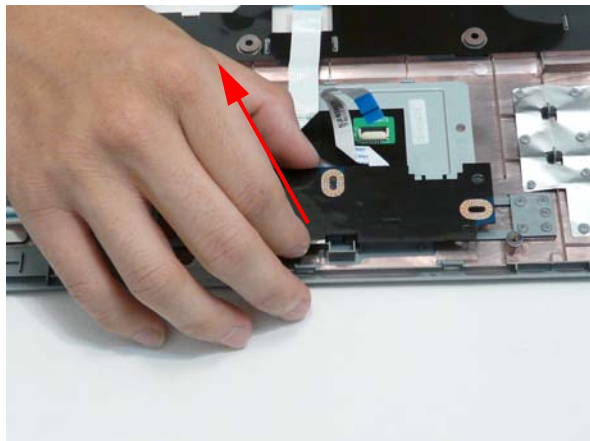

# Removing the Touchpad Bracket

1. See "Removing the Button Board" on page 66.
2. Remove the single screw securing the Touchpad Bracket to the Upper Cover.



Step	Size	Quantity	Screw Type
TouchPad Bracket	M2*3	1	

3. Pull the bracket up from under the securing tabs along the top edge.

**NOTE:** It may be necessary to use a tool to first push the securing tabs back so that the bracket may be more readily removed.

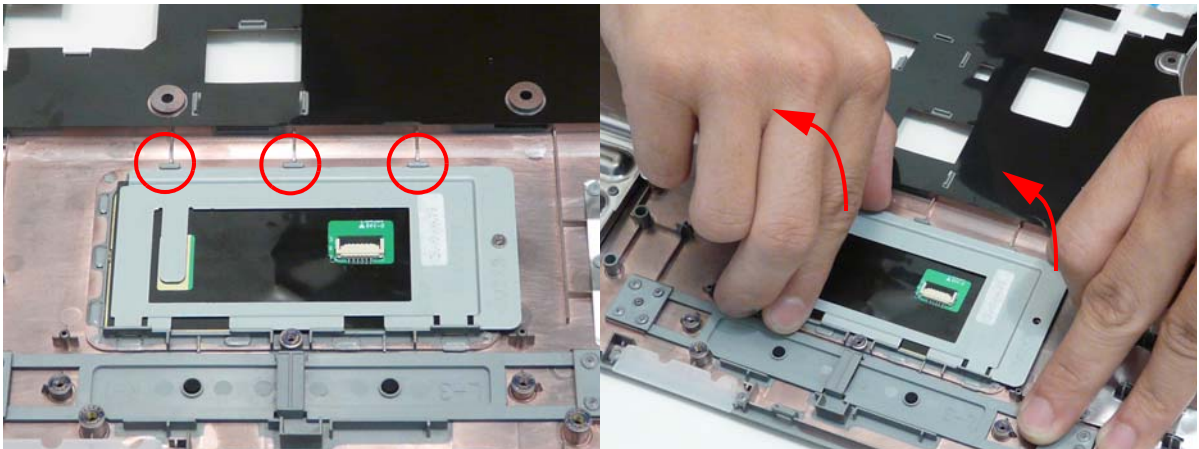

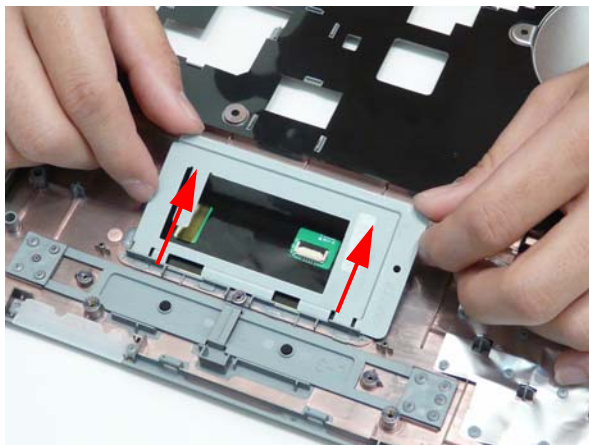

- 
4. Slide the Touchpad Bracket out from the slots in the upper cover.

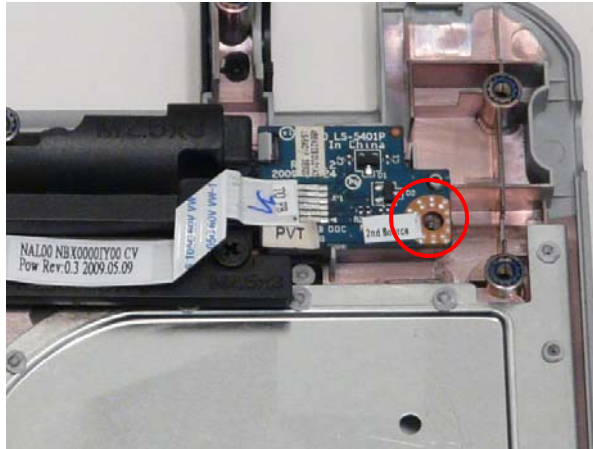

## Removing the Power Board

1. See "Removing the Upper Cover" on page 62.
2. Remove the single screw securing the Power Board to the Lower Cover.



Step	Size	Quantity	Screw Type
Power Board	M2.5*3	1	

3. Pull the FFC up to remove it from the adhesive securing it to the Speaker Module.

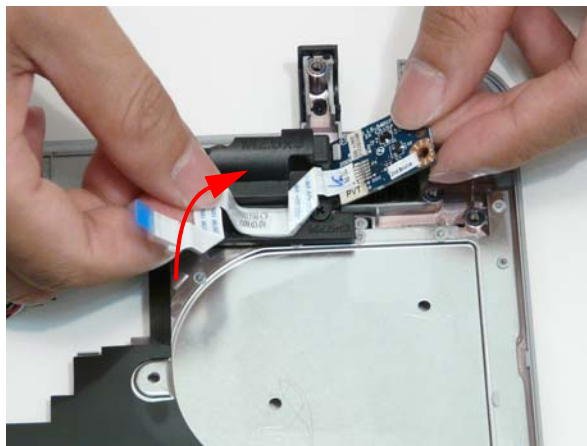

4. Tilt the board 90 degrees to clear the securing tab.



---

**IMPORTANT:**The FFC is soldered to the power board. Take care when lifting to minimize bending of the connection, lest breakage occur.

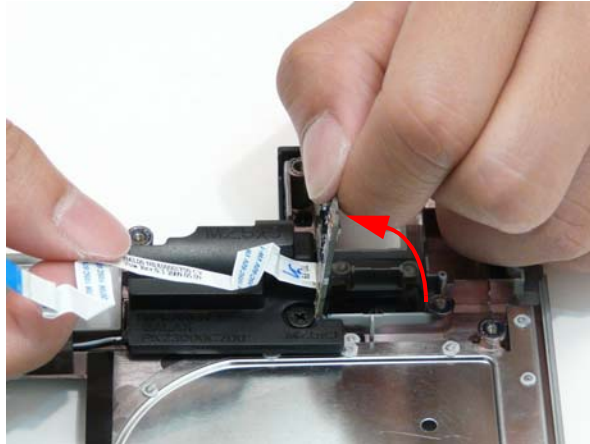

5. Lift the Power Board from the Lower Cover.

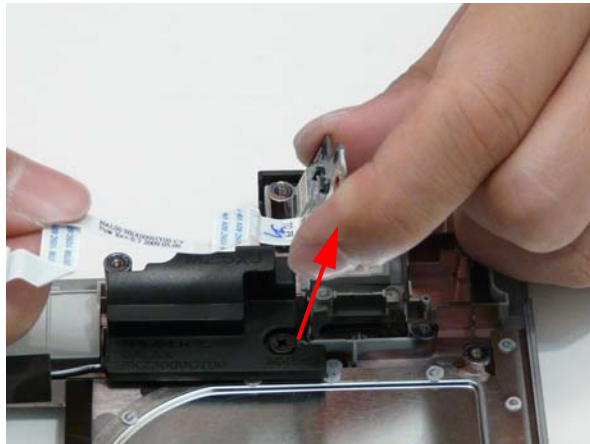

## Removing the Speaker Modules

1. See “Removing the Power Board” on page 70.
2. Remove the four screws securing the Speakers to the Upper Cover.



Step	Size	Quantity	Screw Type
Speaker Module	M2.5*3	4	

3. Lift the right side speaker out from the Lower Cover and peel back the mylar to expose the speaker wire as shown.

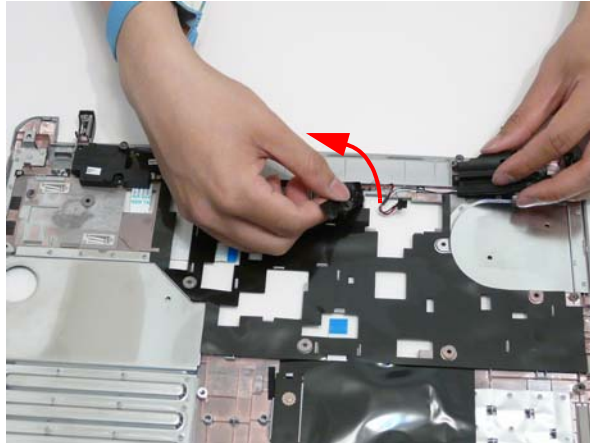

4. Peel back the mylar sheet to expose the speaker cable all the way to the left speaker.

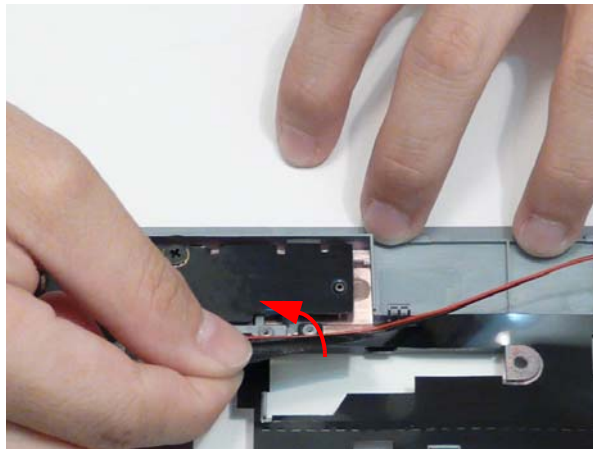

- 
5. Remove the Speaker Cable from the cable channel. Ensure that the cable is free from all cable clips.

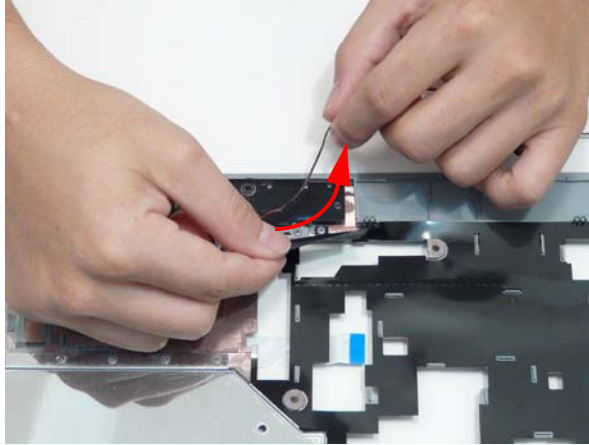

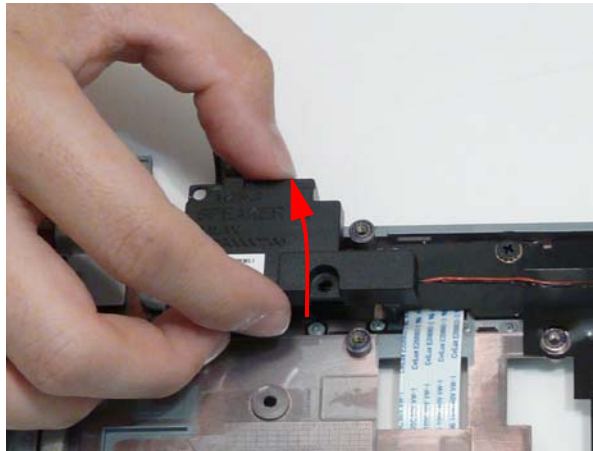

6. Lift the right side speaker out from the Lower Cover as shown.

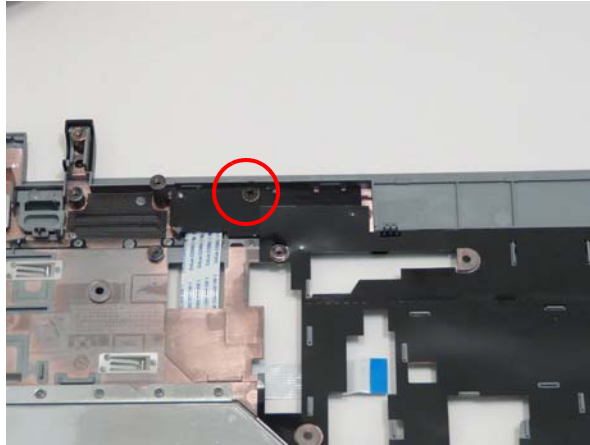

## Removing the Media Board

1. See “Removing the Speaker Modules” on page 72.
2. Remove the single screw securing the Media Board to the Lower Cover.



Step	Size	Quantity	Screw Type
Media Board	M2.5*3	1	

3. Peel back any mylar adhered to the Media Board.

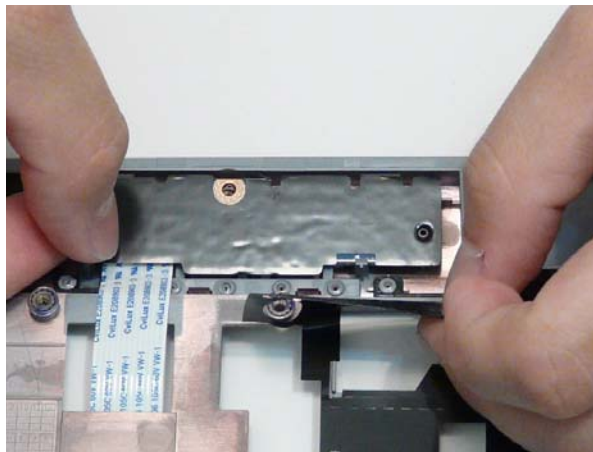

4. Tilt the Media Board up to clear the securing pins.

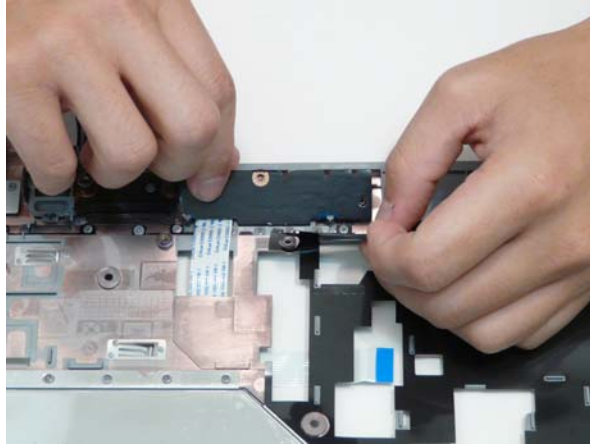

5. Remove the Media Board, pulling the FFC through the cover as shown.  
**IMPORTANT:** Ensure that the FFC is not torn off during removal.

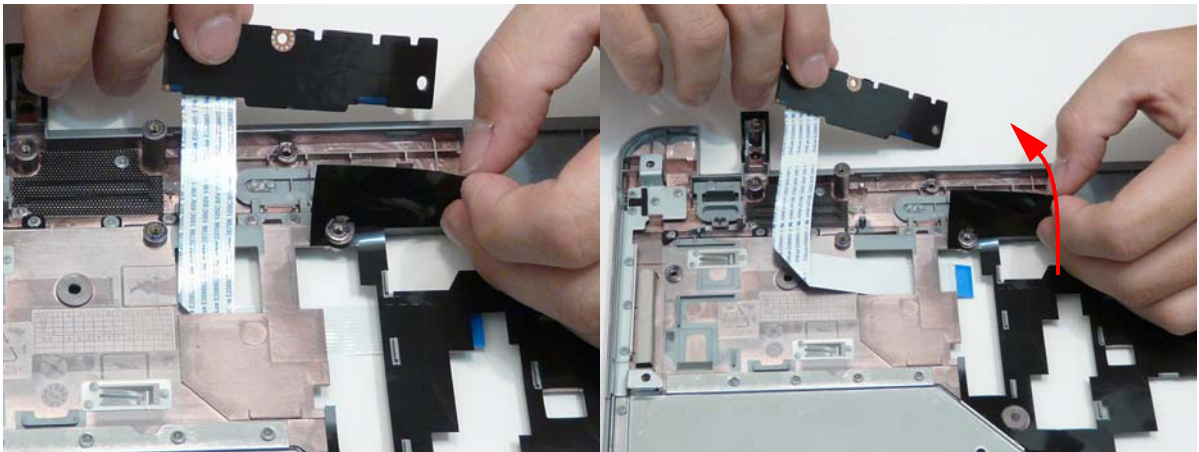



## Removing the I/O Board

1. See “Removing the Upper Cover” on page 62.
2. Open the locking latch and disconnect the FFC from the Mainboard.

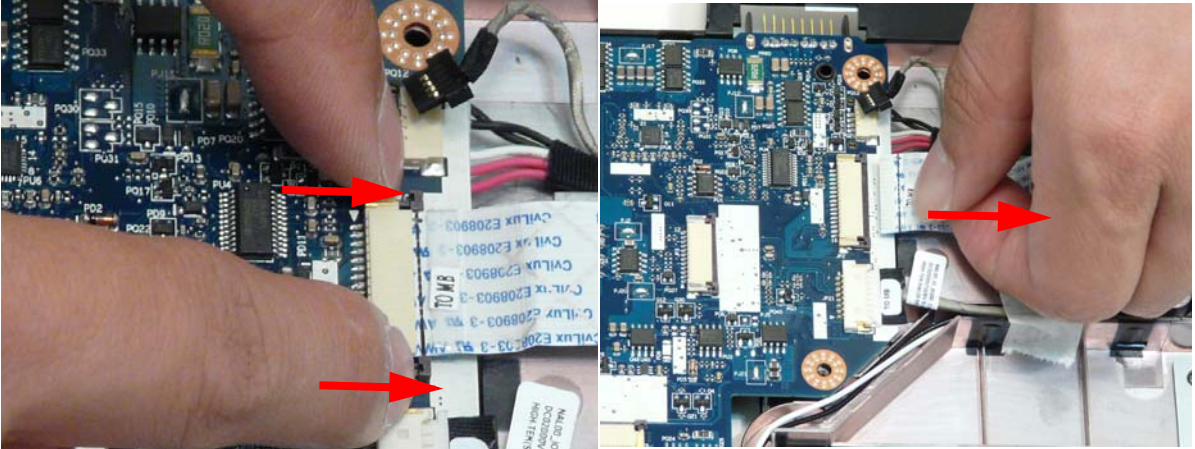

3. Disconnect the cable from the Mainboard.



4. Remove the single screw securing the I/O Board to the Lower Cover.



Step	Size	Quantity	Screw Type
I/O Board	M2.5*6	1	

5. Tilt the board up as indicated and carefully flip the board over.

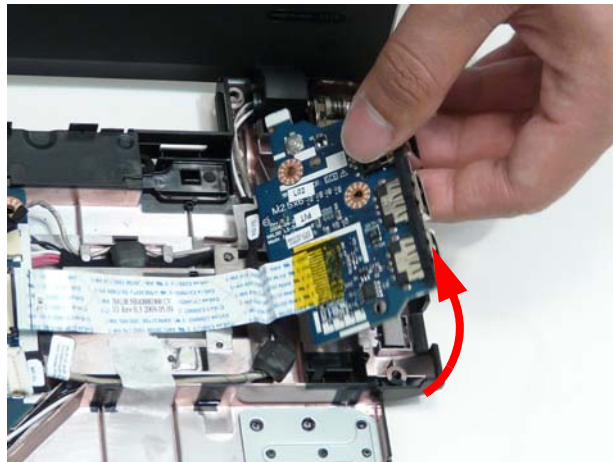

- 
6. Remove the adhesive securing the I/O Board cable to the Lower Cover.

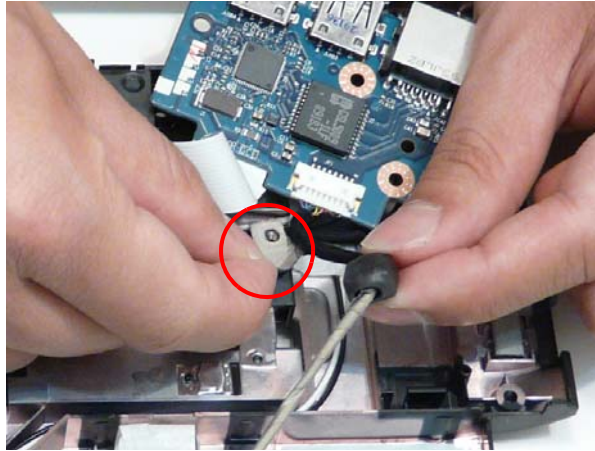

7. Disconnect the I/O Board Cable from the I/O Board.

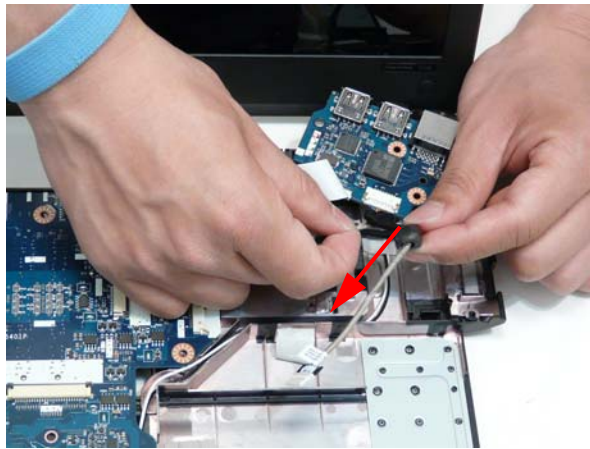



---

## Removing the DC-In Cable

1. See "Removing the I/O Board" on page 76.
2. Remove the DC-In Socket from the well on the bottom cover.

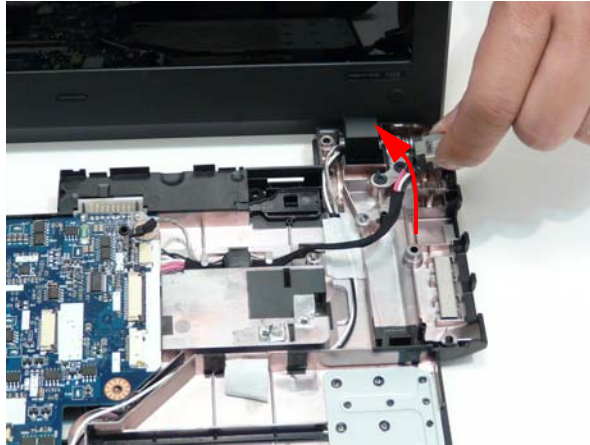

3. Remove the DC cable from the securing clips as shown.

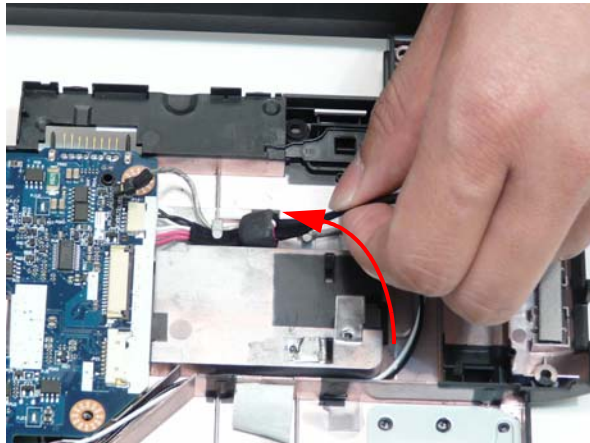

**NOTE:** If replacing the DC cable, the mainboard must be lifted to access the connector. See "Removing the Mainboard" on page 80 for instructions.

---

## Removing the Mainboard

1. See “Removing the DC-In Cable” on page 79.
2. Disconnect the Microphone cable from the Mainboard.

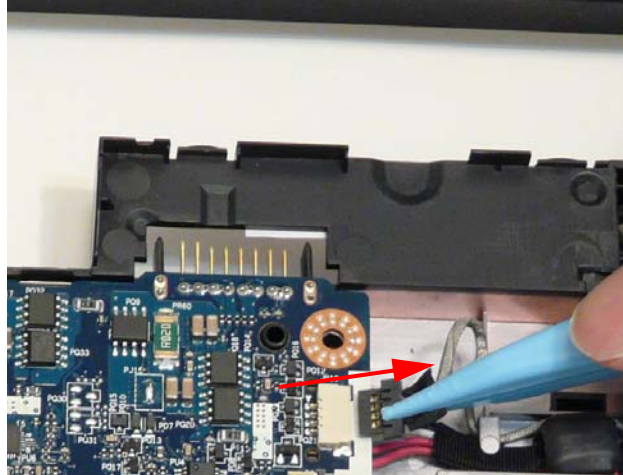

3. Disconnect the Bluetooth cable from the Mainboard.

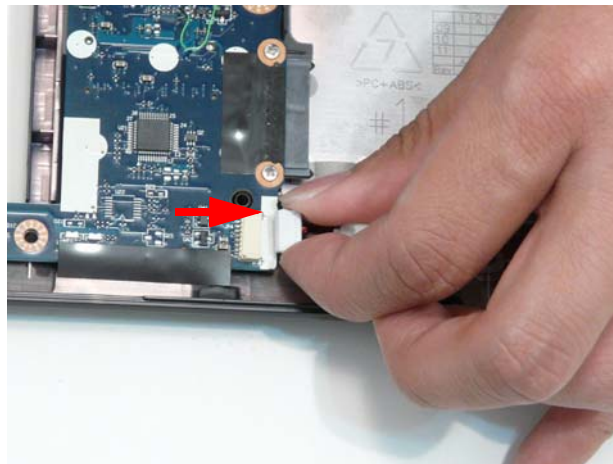

4. Remove the two screws securing the Mainboard and Fan to the Lower Cover as indicated.

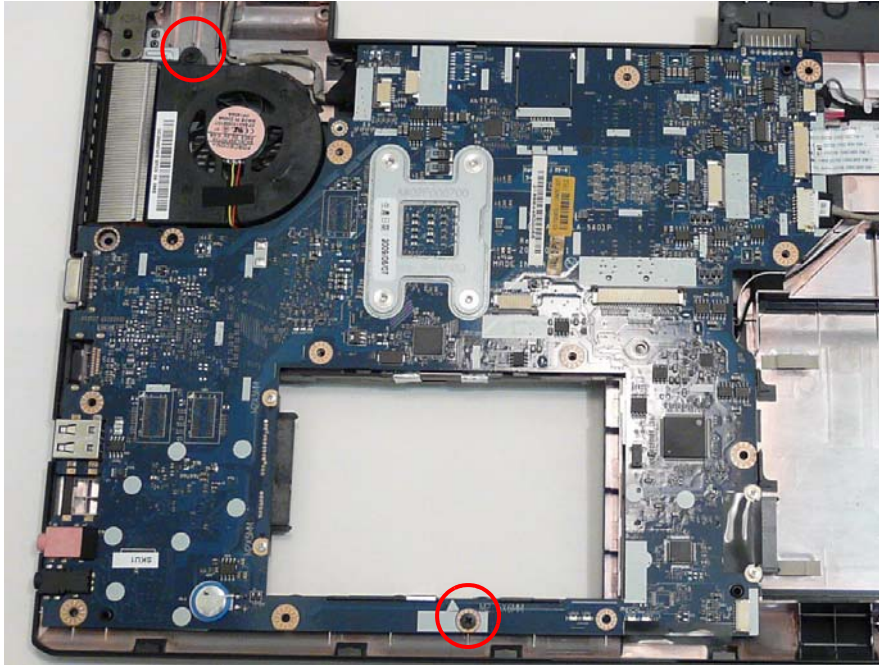

Step	Size	Quantity	Screw Type
Mainboard	M2.5*6	2	

5. Lift the Mainboard right side first to release the I/O ports and separate the board from the Lower Cover.

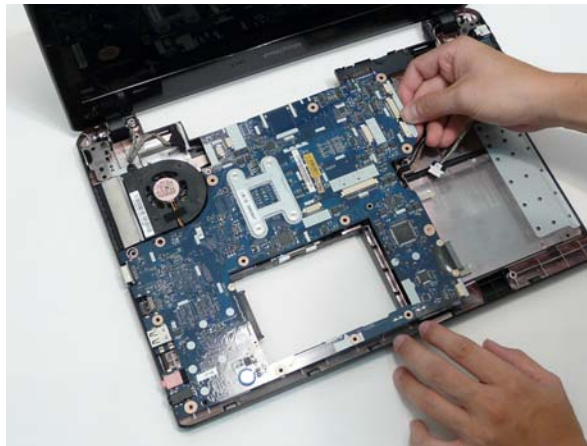

- 
6. Reach under the mainboard to unplug the LVDS cable, and remove the Mainboard from the assembly.

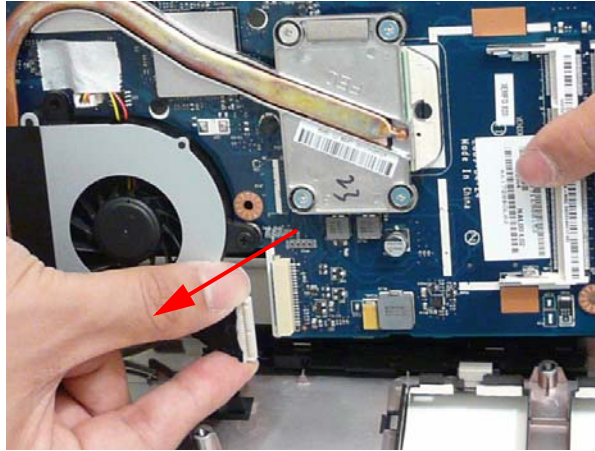

7. Disconnect the DC-In Cable from the mainboard.

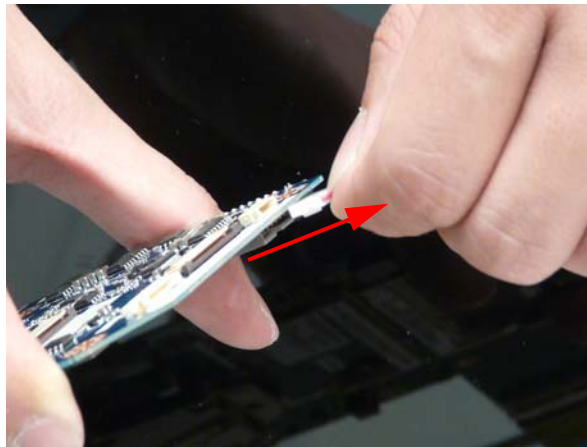



---

## Removing the LCD Module

1. See "Removing the Mainboard" on page 80.
2. Lift the adhesive strip securing the WLAN cables in place.

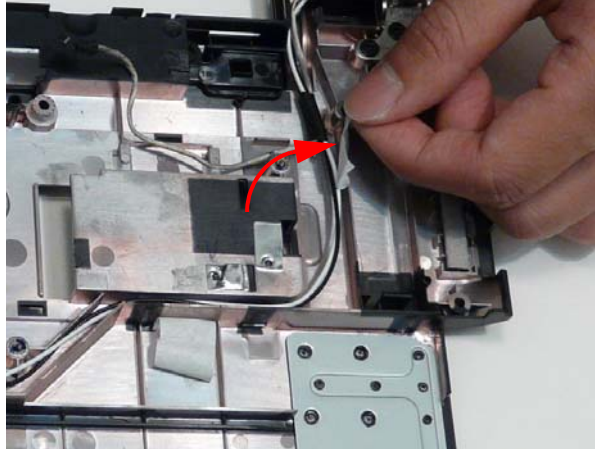

3. Remove the sponge securing the cables in the cable channel

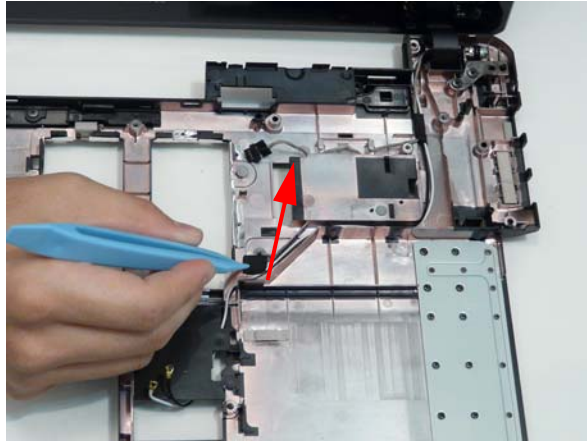

4. Remove the Antenna cables from the cable channel on the Lower Cover as shown, all the way to the hinge well.

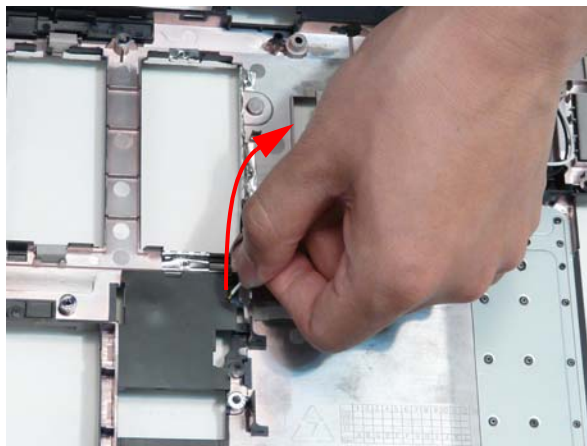

5. Remove the Microphone cable from the securing clips as shown.

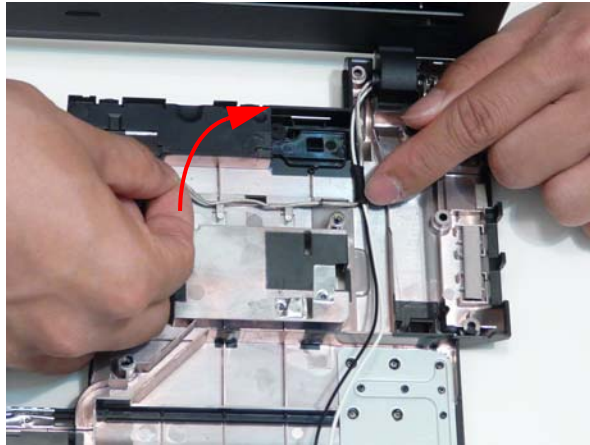

6. Remove the three screws on the rear of the Lower Cover securing the LCD Module to the Lower Cover.

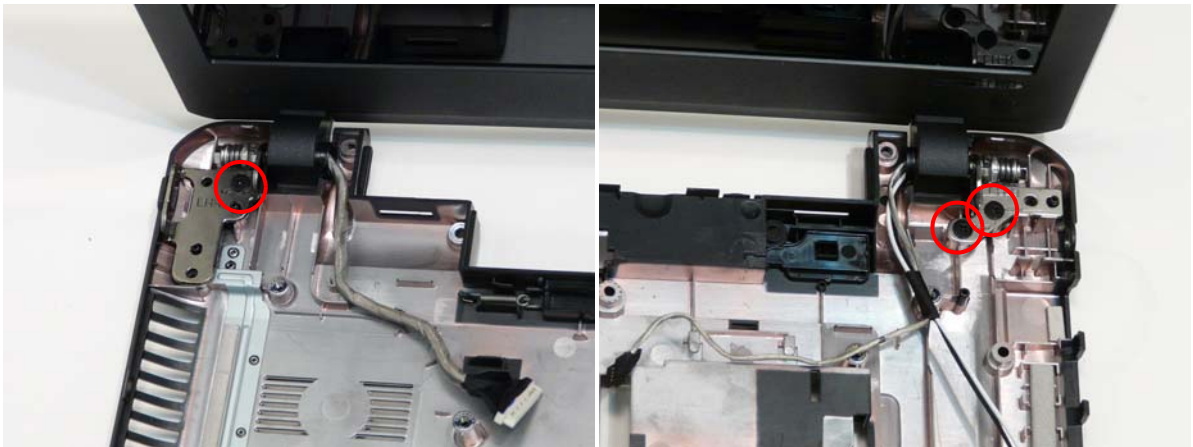

Step	Size	Quantity	Screw Type
LCD Module	M2.5*6	3	

**IMPORTANT:** Ensure that the LCD cables are free from all cable clips before removing the LCD Module.

7. Using both hands, lift the LCD Module away from the Lower Cover.

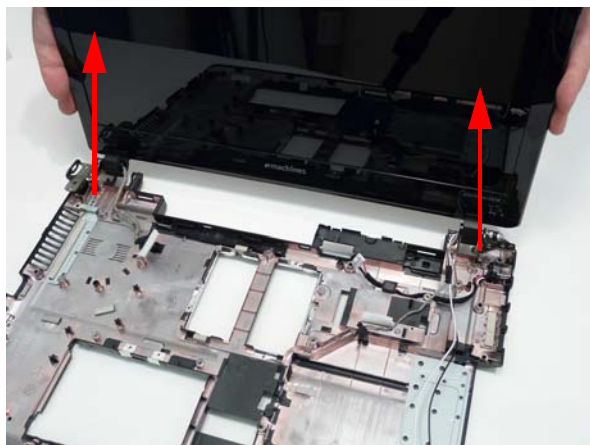

## Removing the Fan

1. See "Removing the Mainboard" on page 80.
2. Disconnect the fan cable from the Mainboard.

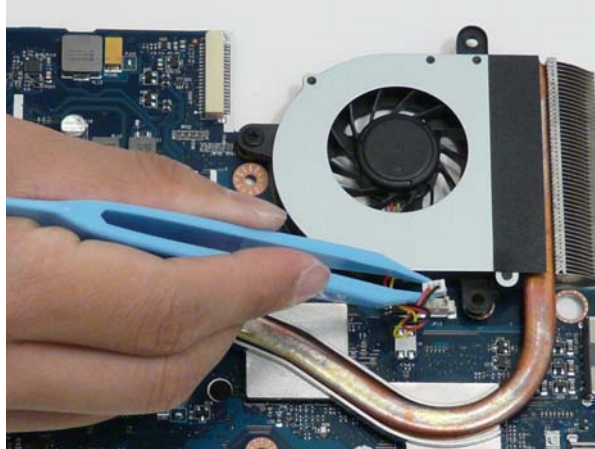

3. Remove the single screw securing the fan to the Mainboard.



Step	Size	Quantity	Screw Type
Fan	M2.5*6	1	

- 
4. Lift the fan away from the Mainboard.





## Removing the Thermal Module

1. See “Removing the Fan” on page 85.
2. Remove the four screws securing the Thermal Module to the Mainboard in the following order: 1, 2, 3, 4.

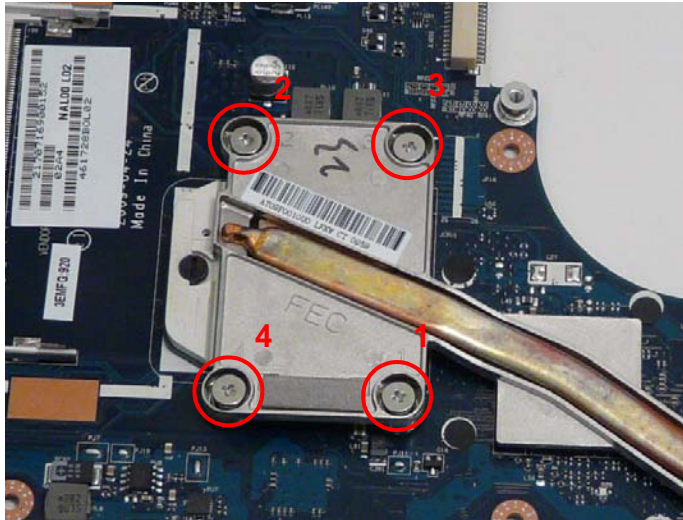

Step	Size	Quantity	Screw Type
Thermal Module	M2.5*6	4	

3. Grasp the Thermal Module by the CPU heat sink and lift clear of the Mainboard as shown.

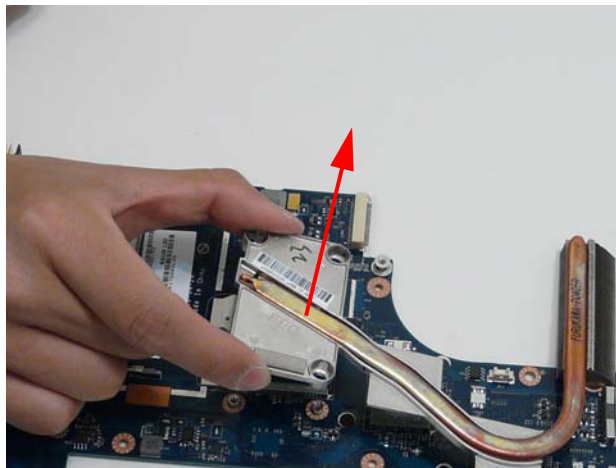

---

## Removing the CPU

1. See “Removing the Thermal Module” on page 87.
2. Using a flat blade screw driver, rotate the CPU screw 180° counter clockwise to release the CPU from the socket.

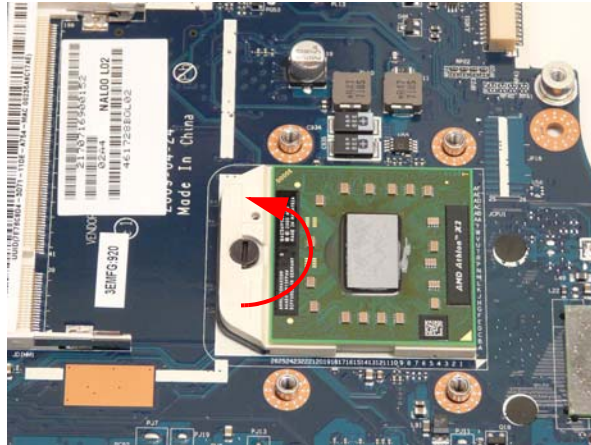

3. Lift the CPU clear of the socket.

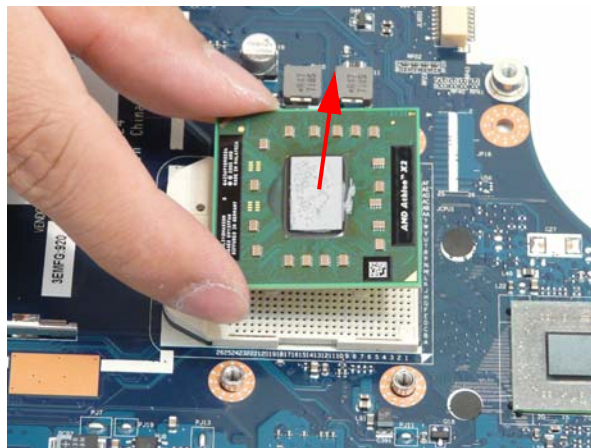

# LCD Module Disassembly Process

**IMPORTANT:** Cable paths and positioning may not represent the actual model. During the removal and replacement of components, ensure all available cable channels and clips are used and that the cables are replaced in the same position.

**NOTE:** The product previews seen in the disassembly procedures may not represent the final product color or configuration.

## LCD Module Disassembly Flowchart

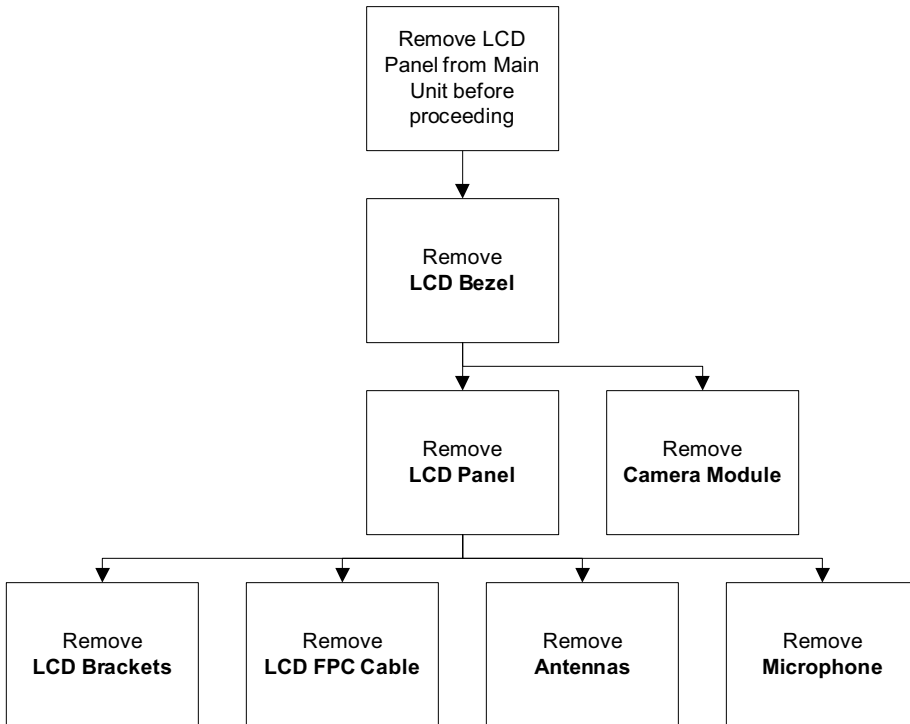

### Screw List

Step	Screw	Quantity	Part No.
LCD Bezel	M2.5*4	4	86.PEA02.003
LCD Panel	M2*3	4	86.PEA02.002

# Removing the LCD Bezel

- 1. See "Removing the LCD Module" on page 83.
- 2. Remove the four screw covers and four screws securing the front bezel to the LCD cover.



Step	Size	Quantity	Screw Type
LCD Bezel	M2.5*4	4	

- 3. Starting from the inside top edge, pry the bezel away from the panel. Continue moving along the top, prying the bezel away from the LCD Module. If necessary, use a plastic pry to release the corners of the bezel.



4. Release the bottom edge of the bezel, separating the securing clips.

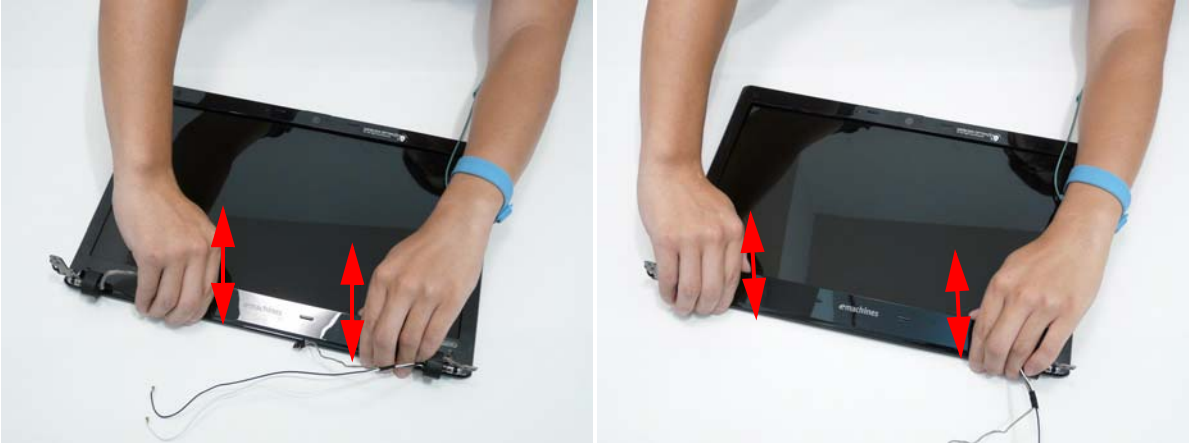

5. Pry apart the hinge covers as shown.



6. Release the bottom edges of the LCD Module.



- 
7. Lift up the bezel and remove it from the LCD Module.





---

## Removing the Camera Board

1. See "Removing the LCD Bezel" on page 90.
2. Remove the Camera Board from the LCD Module.

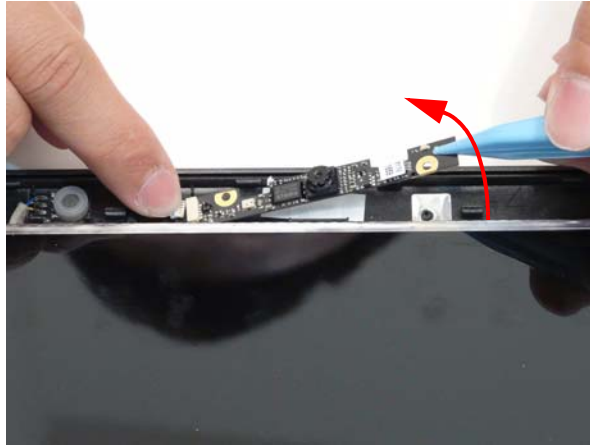

3. Disconnect the cable from the Camera Board as shown.

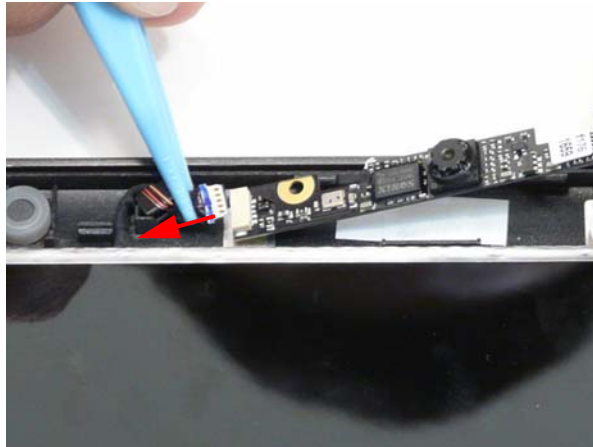

# Removing the LCD Panel

- 1. See "Lift up the bezel and remove it from the LCD Module." on page 92.
- 2. Remove the four screws securing the LCD Panel to the LCD Module.



Step	Size	Quantity	Screw Type
LCD Panel	M2*3	4	

- 3. Lift the LCD Panel out of the LCD Module front edge first.

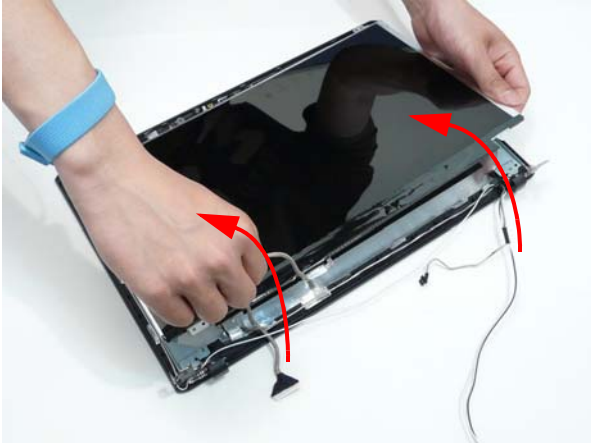



---

## Removing the FPC Cable

1. See "Removing the LCD Panel" on page 94.
2. Turn the LCD panel over on a clean surface.



3. Lift the camera cable to detach the adhesive securing the cable to the LCD Panel.

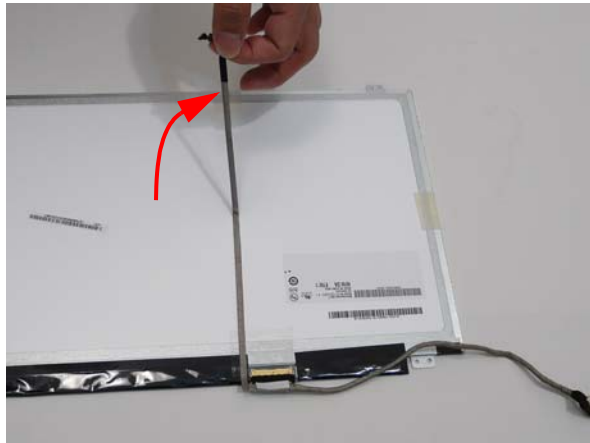

4. Carefully lift the adhesive tape securing the LVDS cable connector to the LCD Panel.



- 
5. Hold the adhesive tape clear of the LCD Panel.



6. Disconnect the LCD cable as shown and remove the cable from the LCD Panel.

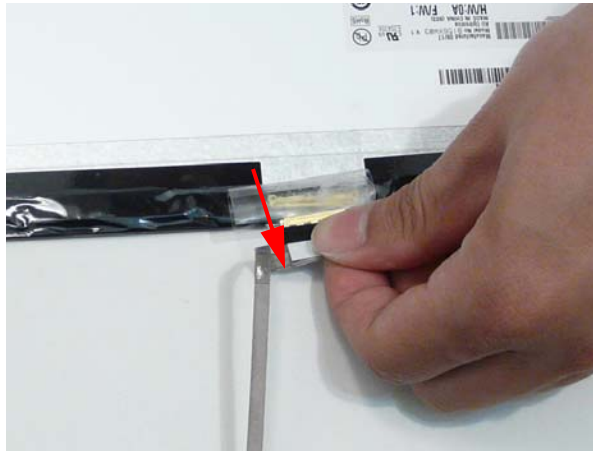

---

## Removing the LCD Brackets

1. See "Removing the LCD Panel" on page 94.
2. Pick up the antenna cable so the bracket can clear the cable.
3. Lift the top of the left LCD Bracket up and slide out from under the antenna cable.

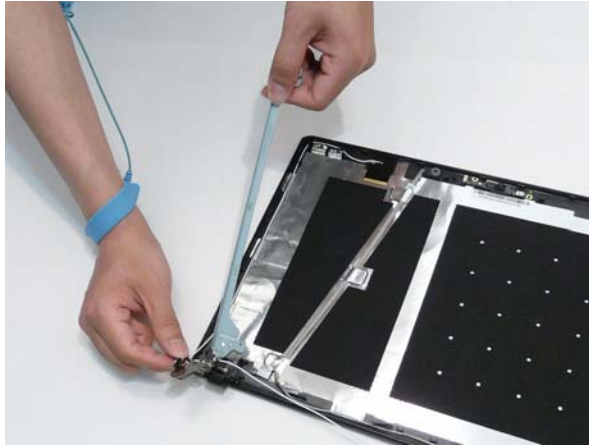

4. Lift the top of the right LCD Bracket up and slide out from under the antenna cable.

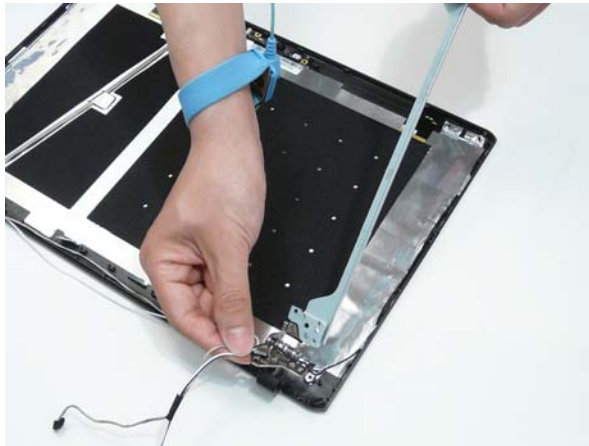

---

## Removing the Microphone

1. See "Removing the LCD Panel" on page 94.
2. Remove the tape securing the Microphone cable to the antenna cables.



3. Remove the Microphone cable from the shielding along the bottom edge of the LCD Cover.

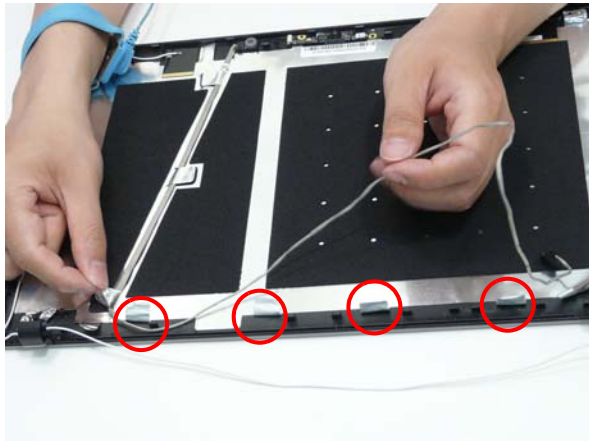

4. Lift up the shielding where it covers the Microphone cable and lift the cable as shown to remove the adhesive securing it to the LCD Cover.

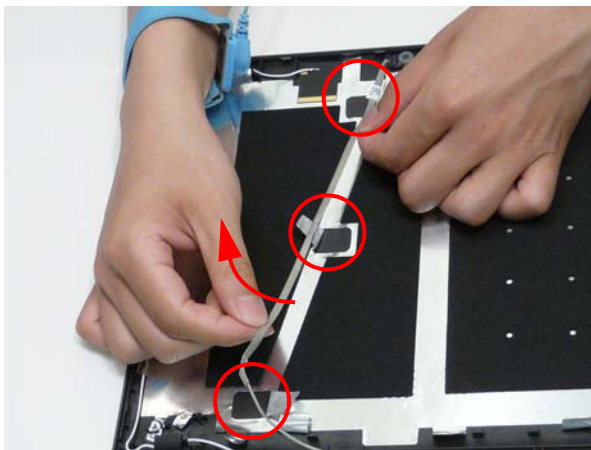

- 
5. Lift the Microphone Module upward to detach the adhesive holding it in place.

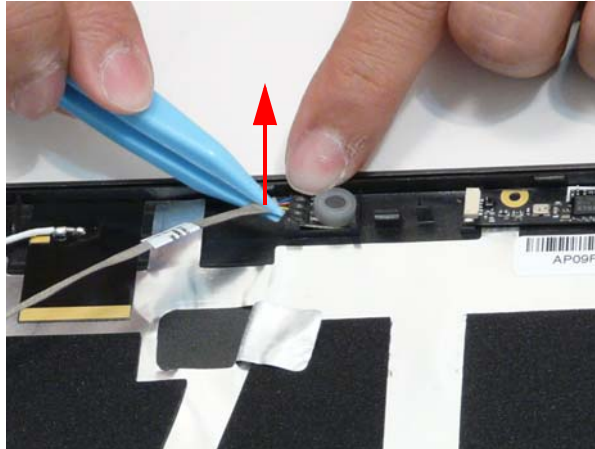

---

## Removing the Antennas

1. See "Removing the LCD Panel" on page 94.
2. Remove the tape securing the Microphone cable to the antenna cables.



3. Lift up the shielding holding the right Antenna cable in place. Ensure that the cable is free from all fasteners.

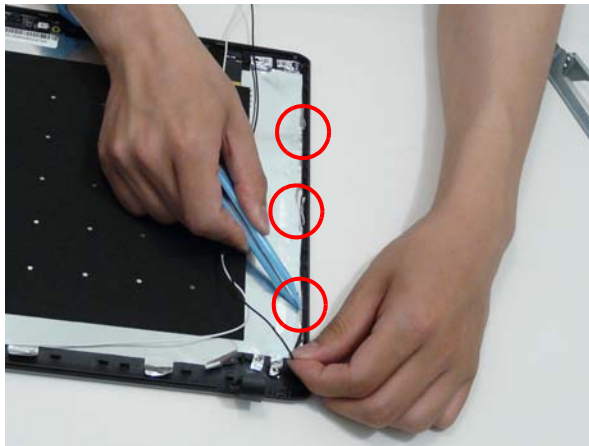

4. Carefully pry up the right Antenna pad, as shown, and remove the pad from the LCD Module.

**IMPORTANT:** A strong adhesive is used to secure the Antenna pad in place. Take care not to bend the pad during removal.



- 
5. Lift up the shielding holding the left Antenna cable in place. Ensure that the cable is free from all fasteners.

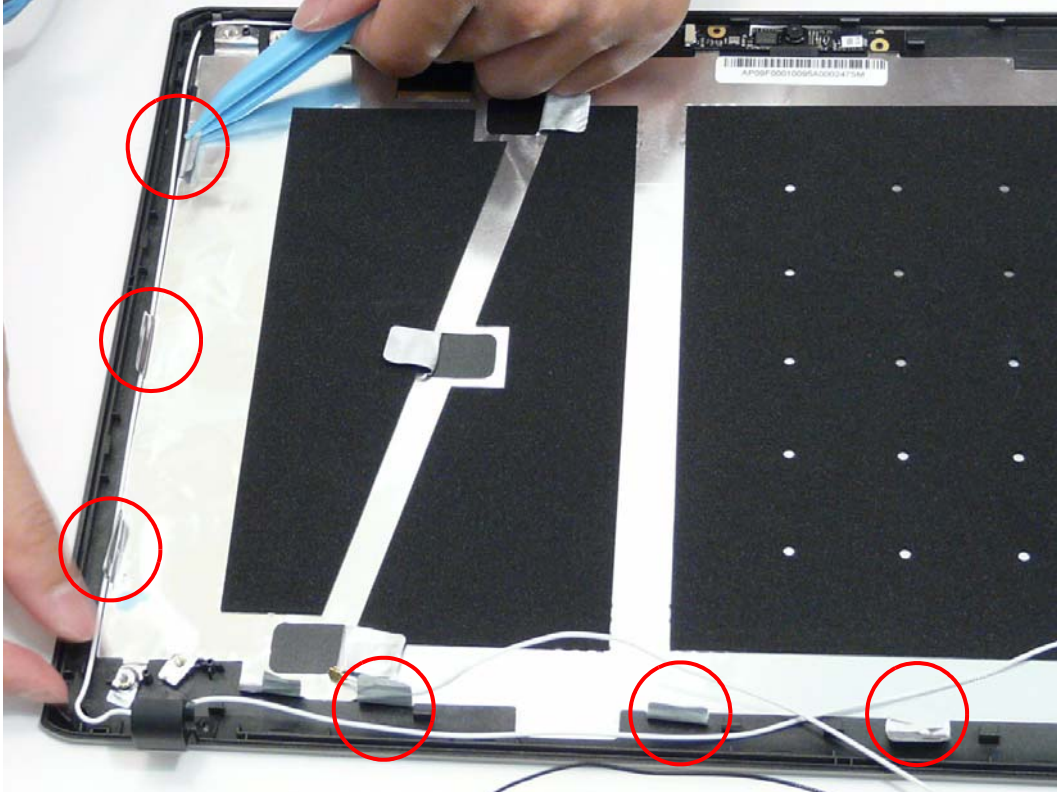

6. Carefully pry up the left Antenna pad and remove the pad from the LCD Module.

**IMPORTANT:** A strong adhesive is used to secure the Antenna pad in place. Take care not to bend the pad during removal.



---

# LCD Module Reassembly Procedure

## Replacing the Antennas

1. Adhere the Left Antenna Pad (White cable) to the LCD Cover as shown.

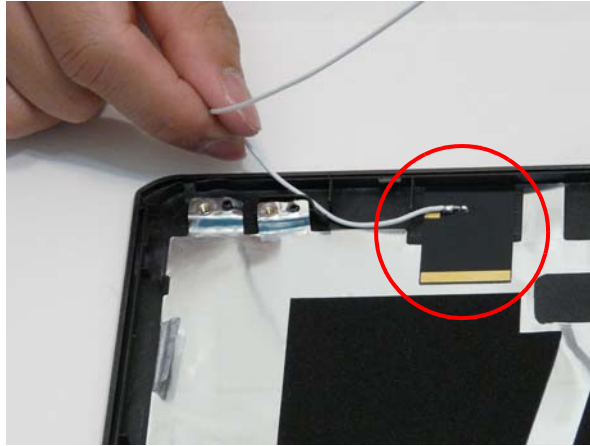

2. Replace the shielding to secure the left Antenna cable in place. Ensure that the cable passes under all fasteners.

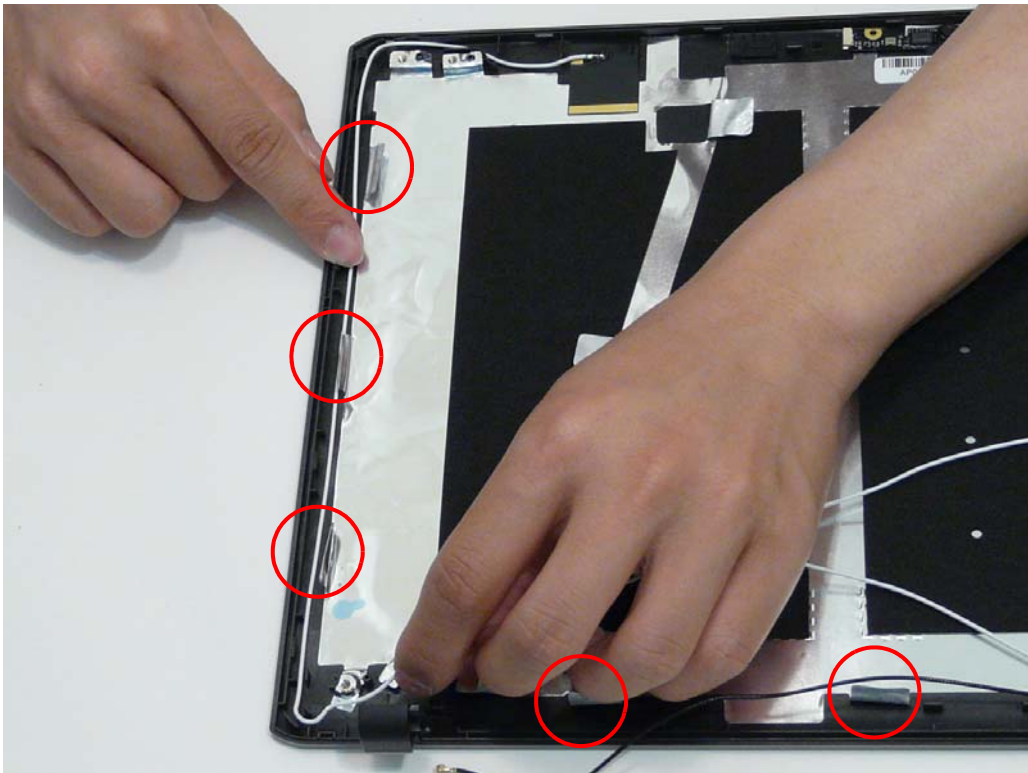



3. Adhere the Left Antenna Pad (Black cable) to the LCD Cover as shown.



4. Replace the shielding to secure the right Antenna cable in place. Ensure that the cable passes under all fasteners.

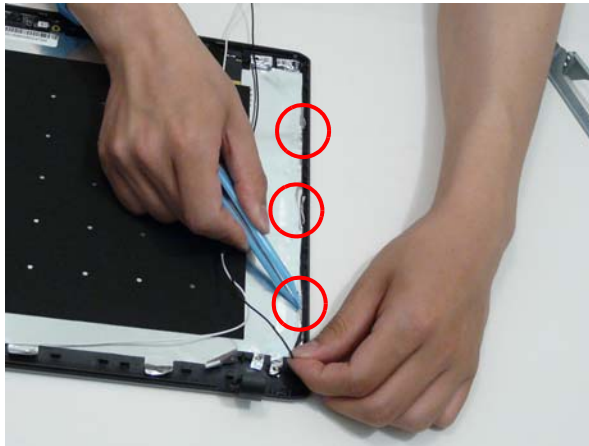

## Replacing the Microphone

1. Push the Microphone Module in place as shown.

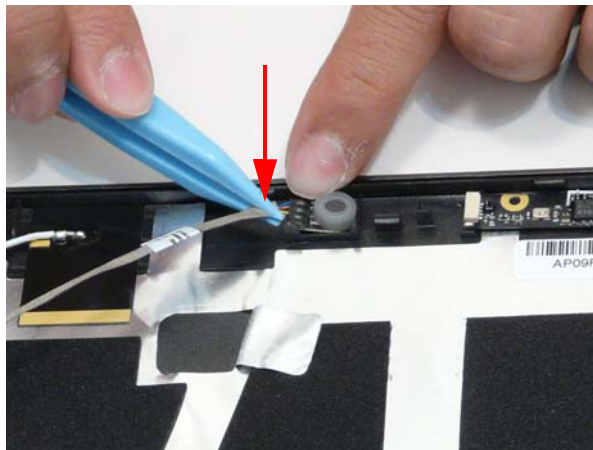

- 
2. Press the cable onto the LCD cover as shown to secure it in place. Adhere the shielding tabs where they cover the Microphone cable.

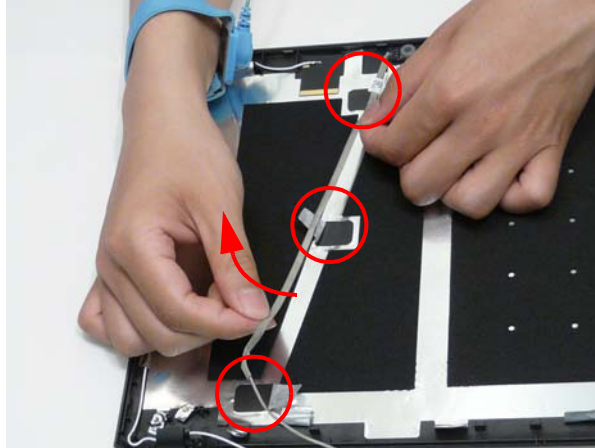

3. Secure the Microphone cable under the shielding tabs along the bottom edge of the LCD Cover.

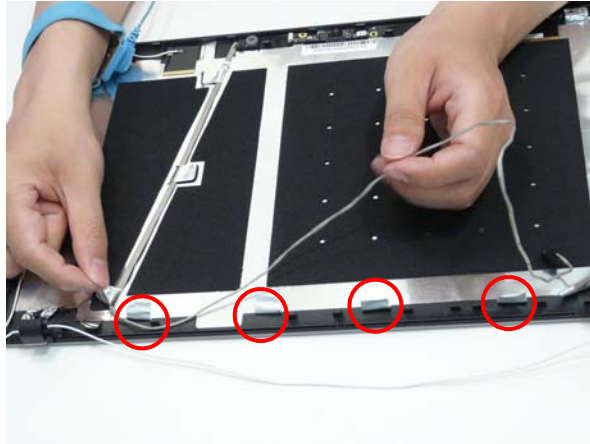

4. Apply tape to secure the Microphone cable to the antenna cables.



---

## Replacing the LCD Brackets

1. Lift the antenna cable and slide the left LCD Bracket under the antenna cable.

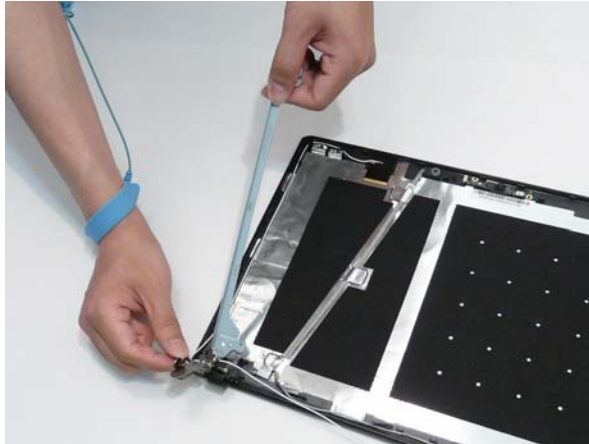

2. Place the LCD bracket on the LCD cover so the LCD Cover pins penetrate the bracket.

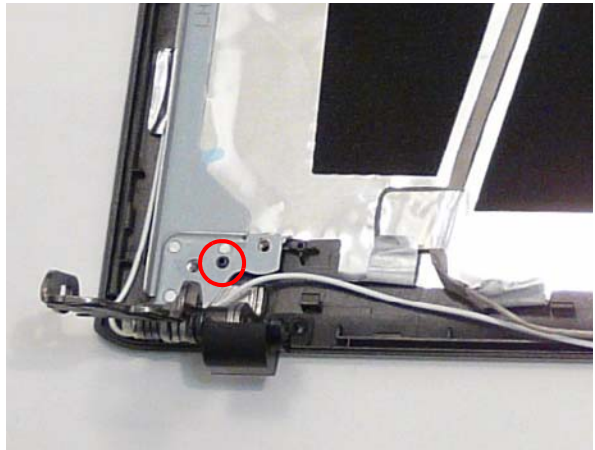
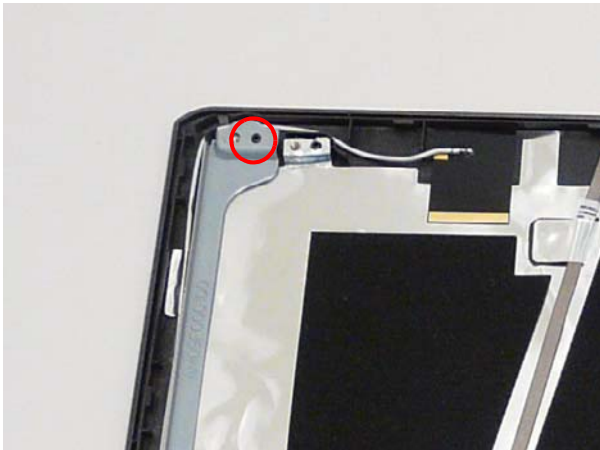

3. Lift the antenna cable and slide the right LCD Bracket under the antenna cable.

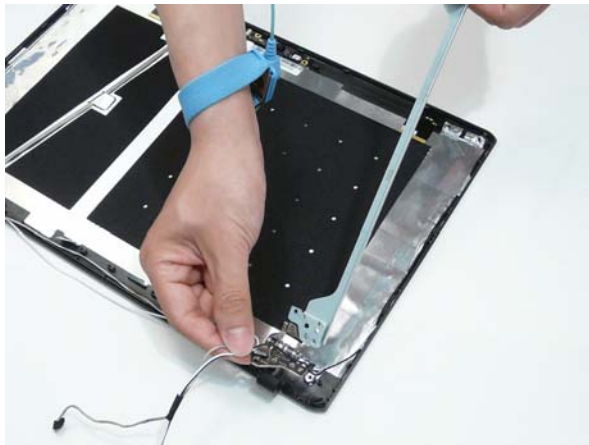

4. Place the LCD bracket on the LCD cover so the LCD Cover pins penetrate the bracket.

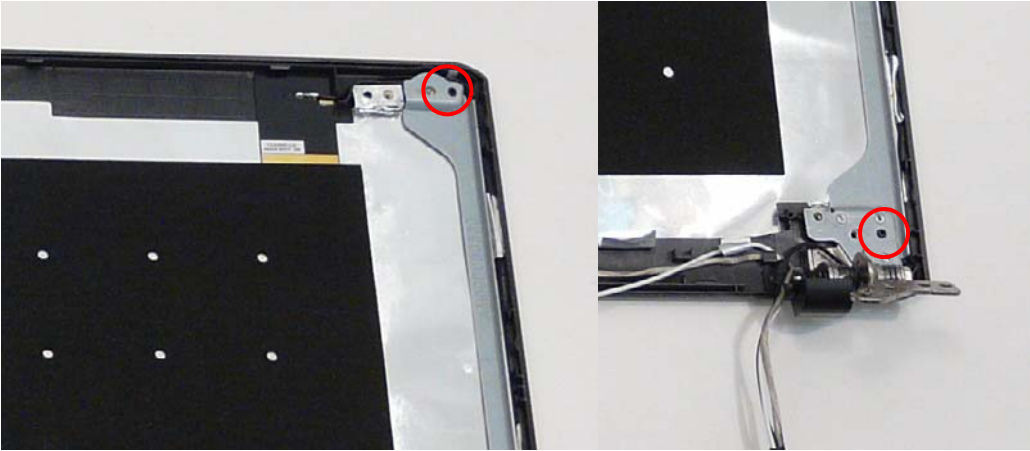

## Replacing the FPC Cable

1. Connect the LCD cable as shown.

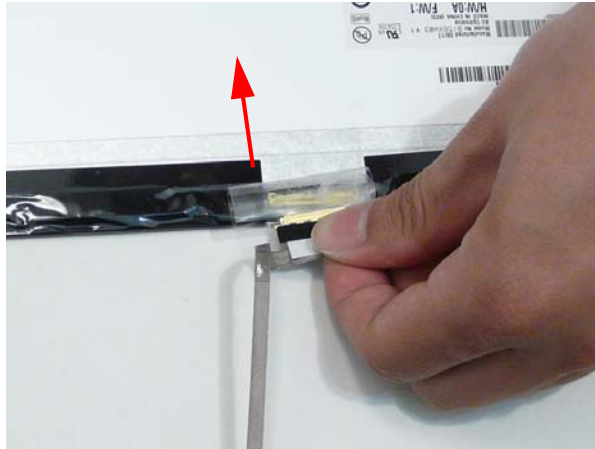

2. Adhere the clear adhesive tape to the LCD Panel.

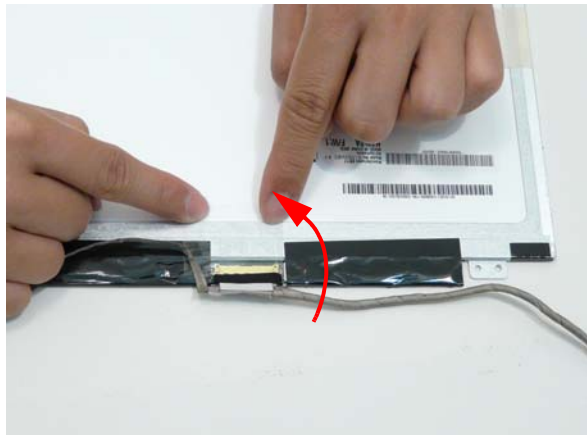

- 
3. Adhere the camera cable to the LCD Panel.

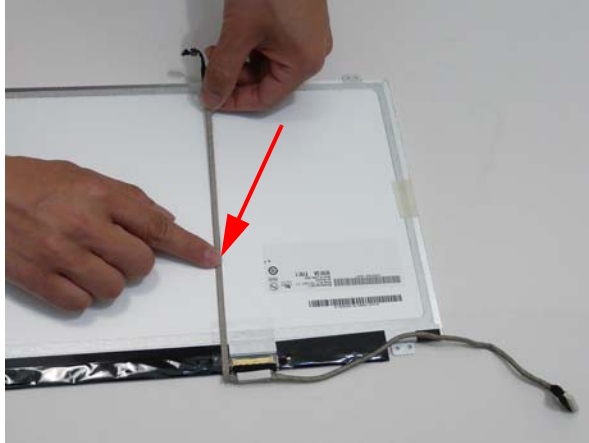

## Replacing the LCD Panel

1. Place the LCD Panel into of the LCD Cover back edge first, aligning the pins with the holes in the mounting tabs.

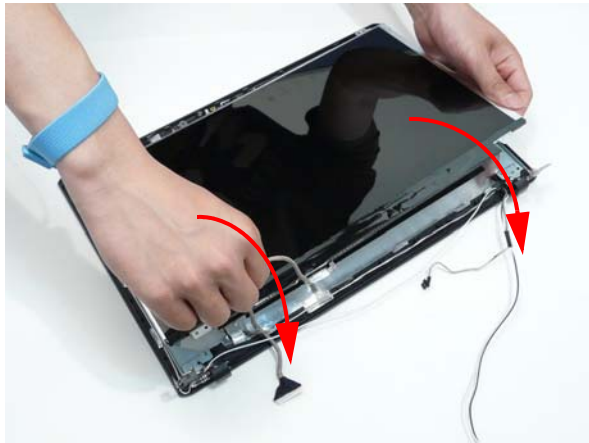

2. Insert the four screws to secure the LCD Panel to the LCD Module.



Step	Size	Quantity	Screw Type
LCD Panel	M2*3	4	

## Replacing the Camera Board

1. Connect the cable to the Camera Board as shown.

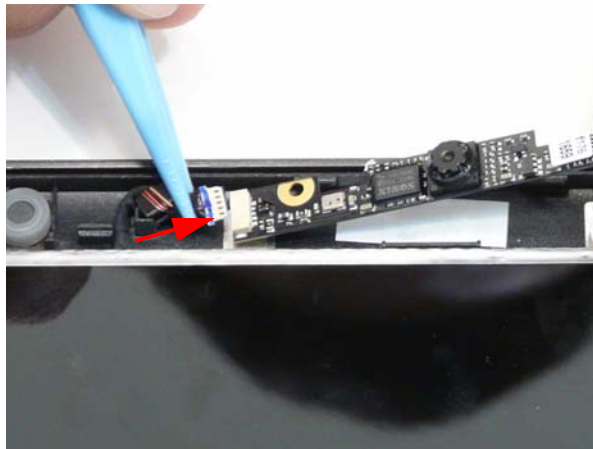



2. Place the Camera Board into the LCD Module so that the mounting pins are aligned and press down to secure to the adhesive.



**NOTE:** Be sure the magnet rests next to the post on the LCD cover as shown.

## Replacing the LCD Bezel

1. Route the LVDS cable through the cable channel and hinge cover as shown.

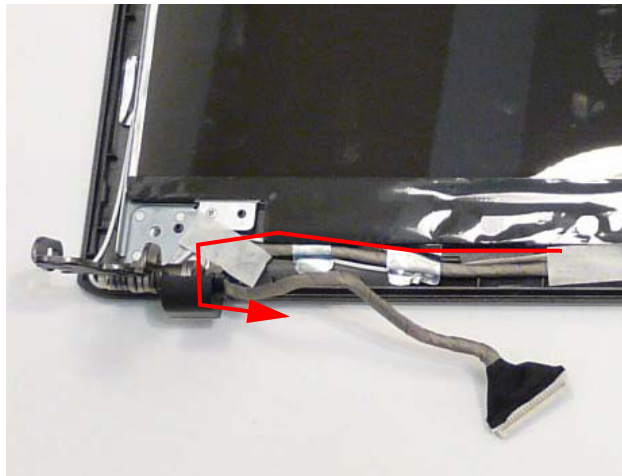

2. Route the Antenna cables and microphone cable through the cable channel and hinge cover as shown.

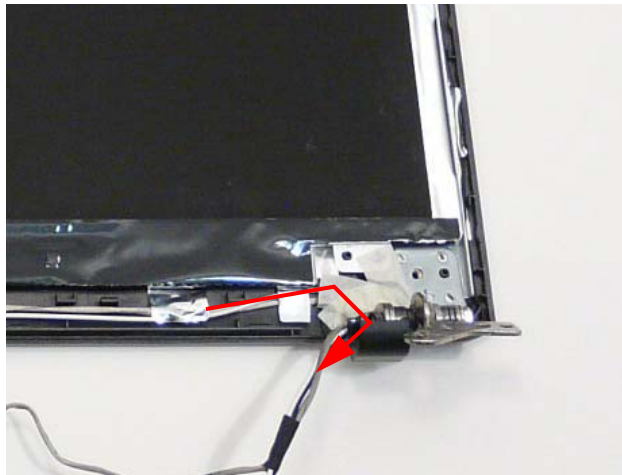

3. Connect the left and right hinge cover part of the LCD bezel, making sure that the cables pass through the holes.



4. Press down on the bottom edge of the bezel until the securing clips snap into place.

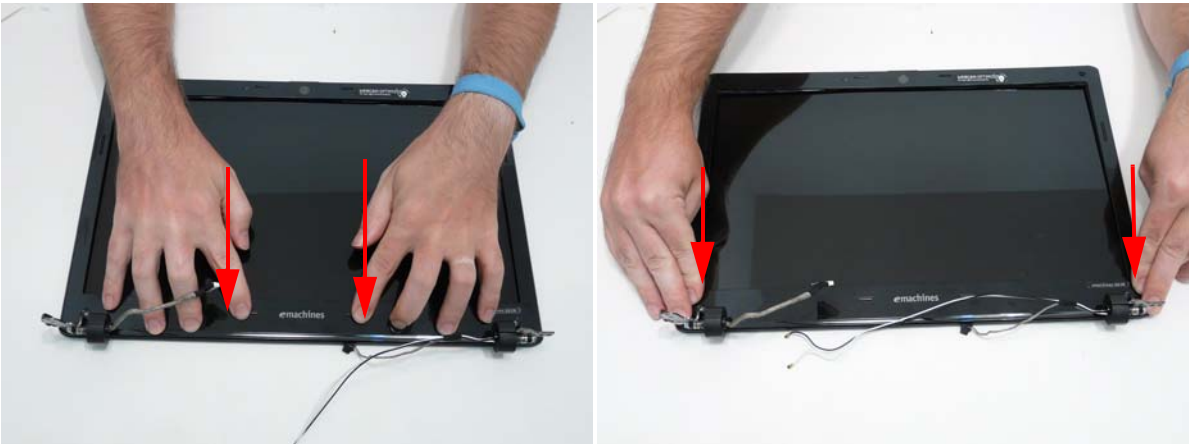

5. Continue pressing down along the edges, working towards the top of the LCD Module.

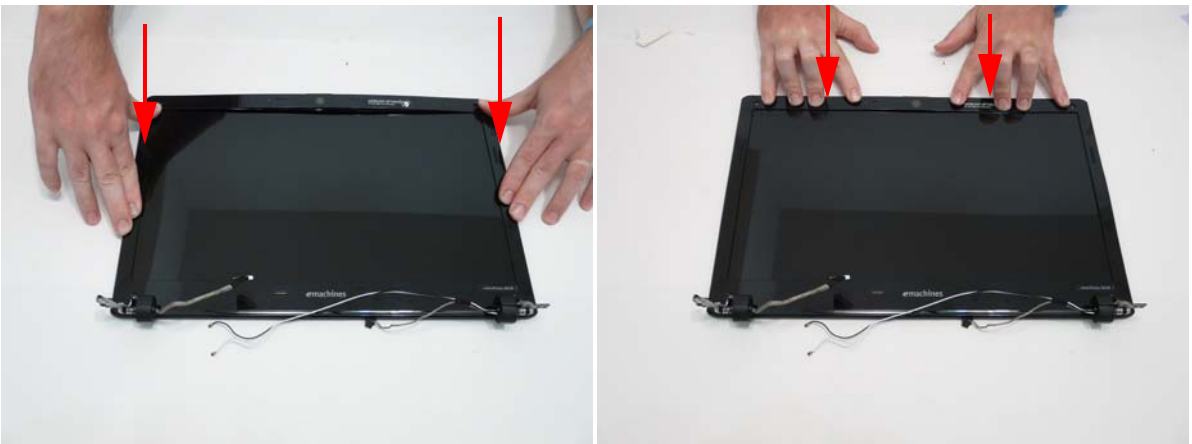

**IMPORTANT:** If any of the clips do not readily snap into place, check to make sure that none of the cables have been incorrectly routed and are blocking the clip.



# Main Unit Reassembly Process

## Replacing the LCD Module

- 1. Using both hands, place the LCD Module into the Lower Cover.

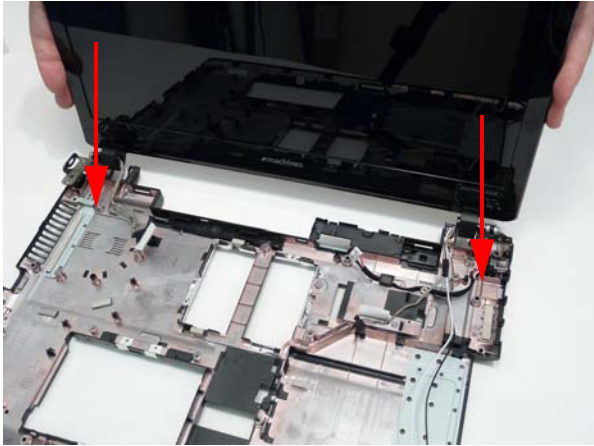

- 2. Replace the three screws on the rear of the Lower Cover to secure the LCD Module to the Lower Cover.

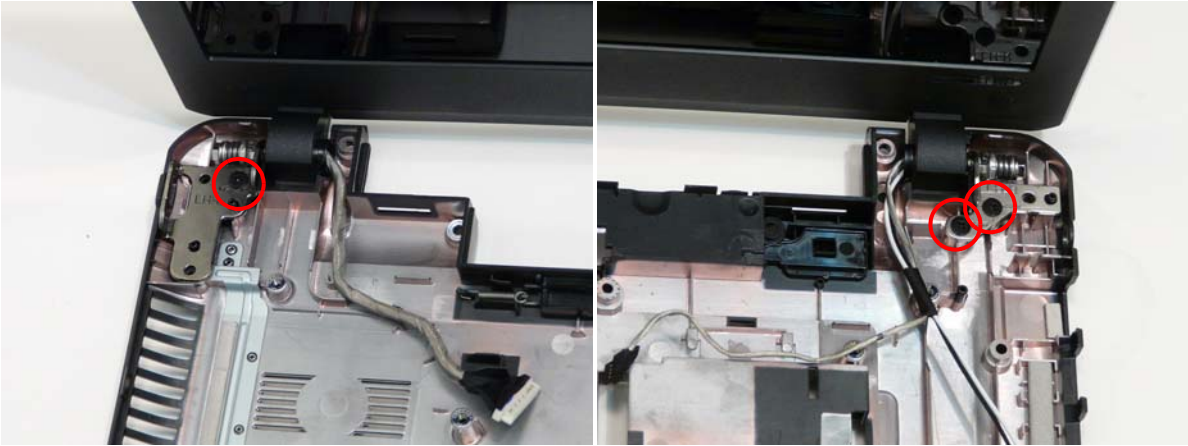

Step	Size	Quantity	Screw Type
LCD Module	M2.5*6	3	

3. Insert the Microphone cable into the securing clips as shown.

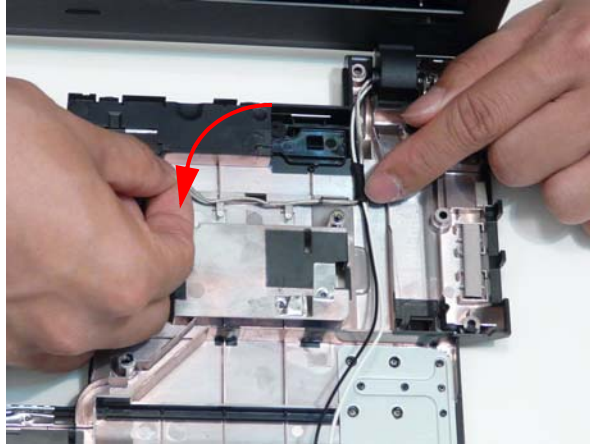

4. Insert the Antenna cables into the cable channel on the Lower Cover as shown, pushing the cables through the penetration to the bottom of the cover.

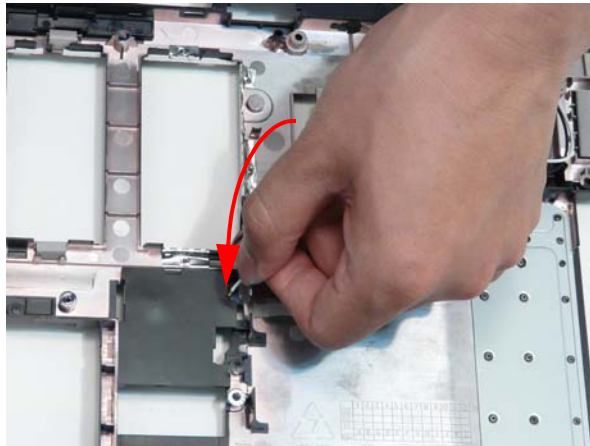

5. Replace the adhesive strip to secure the WLAN cables in place.

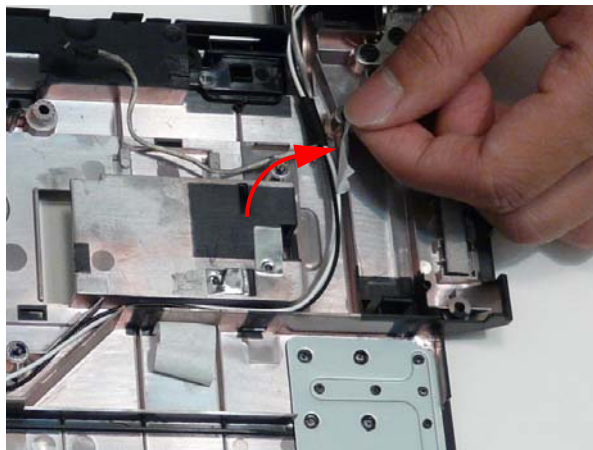

---

## Replacing the CPU

1. Place the CPU into the socket.

**IMPORTANT:** Be sure to align the socket marker with the indicator on the CPU. The socket is a Zero Insertion Force (ZIF) socket. If the CPU does not drop into the socket, check to make sure the socket is unlocked and the pins of the CPU are straight. Never force a CPU into a ZIF socket.

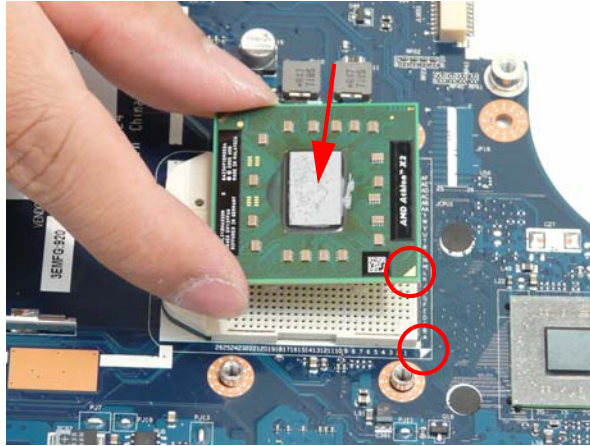

2. Using a flat blade screw driver, rotate the CPU screw 180° clockwise to lock the CPU into the socket.

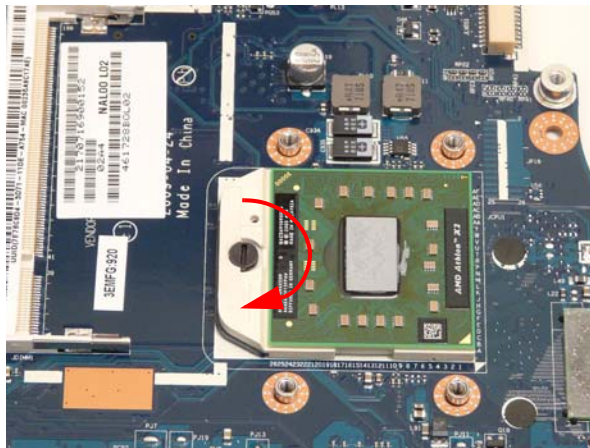

## Replacing the Thermal Module

**IMPORTANT:** Ensure all heat pads are in place before replacing the Thermal Module.

The following thermal pads are approved for use:

- Eapus XR-PE
1. Remove all traces of thermal grease or pad adhesive from the CPU and thermal module using a lint-free cloth or cotton swab and Isopropyl Alcohol, Acetone, or other approved cleaning agent.

2. Place the pads as shown.

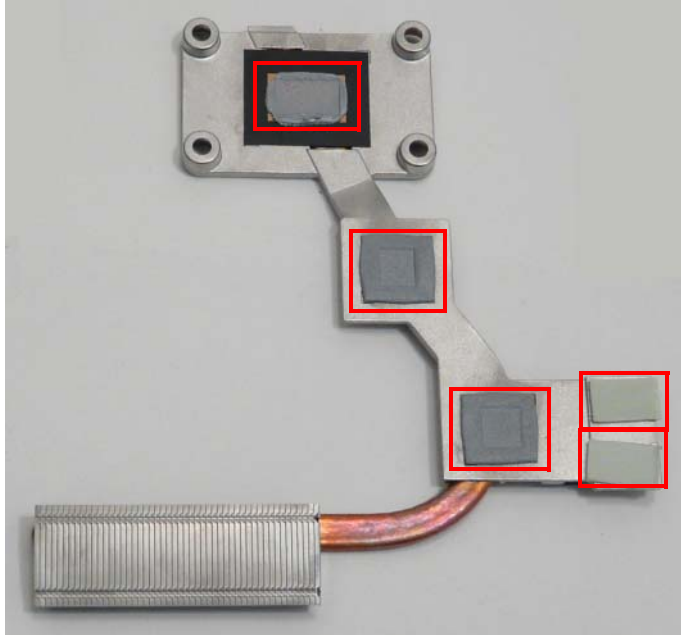

3. Grasp the Thermal Module by the CPU heat sink and place onto the Mainboard as shown.

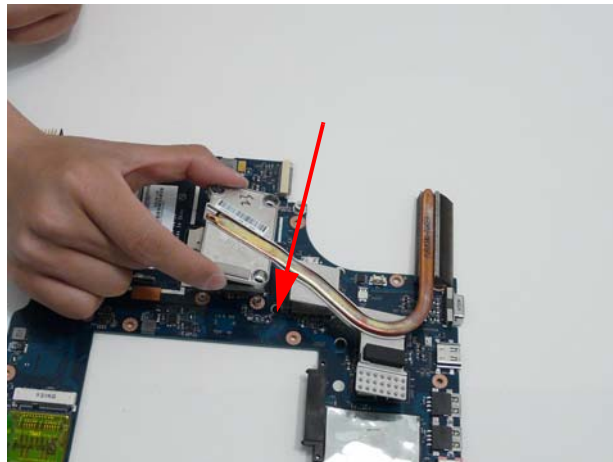

4. Insert the four screws to secure the Thermal Module to the Mainboard in the following order: 1, 2, 3, 4.

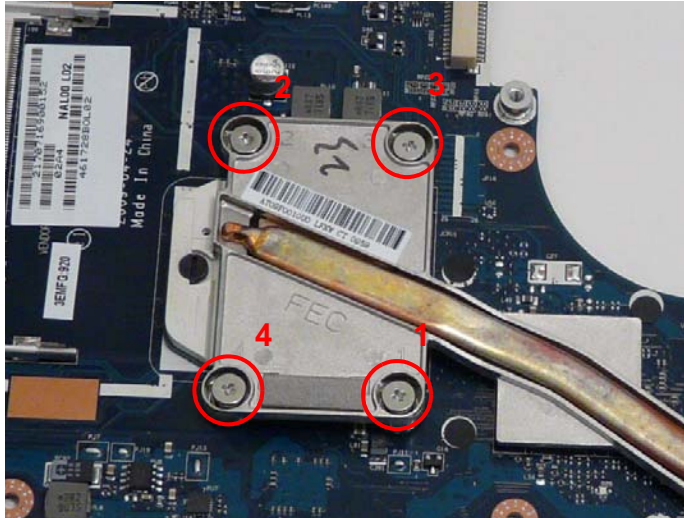

Step	Size	Quantity	Screw Type
Thermal Module	M2.5*6	4	

## Replacing the Fan

1. Place the fan onto the Mainboard.

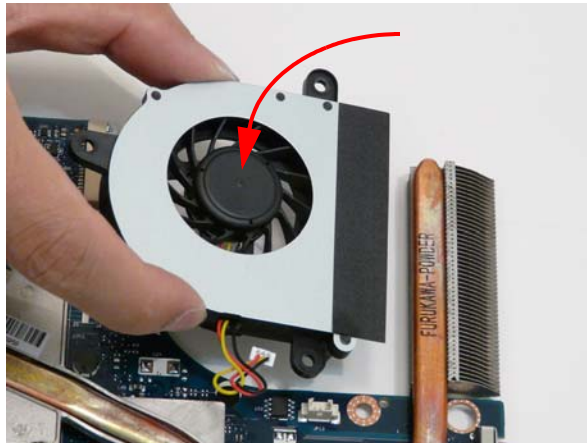



2. Insert the single screw to secure the fan to the Mainboard.

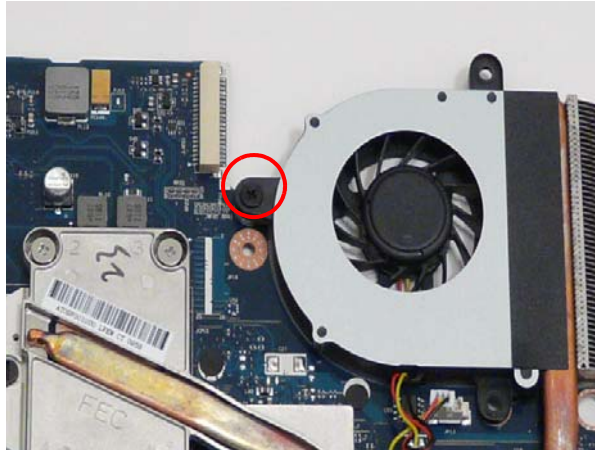

Step	Size	Quantity	Screw Type
Fan	M2.5*6	1	

3. Connect the fan cable to the Mainboard.

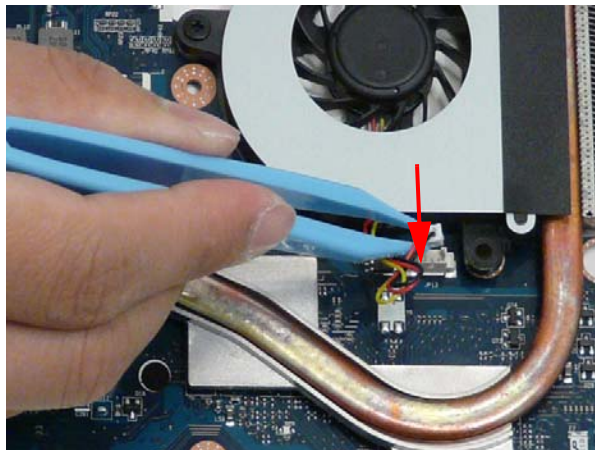

---

# Replacing the Mainboard

1. Connect the DC-In Cable to the mainboard.

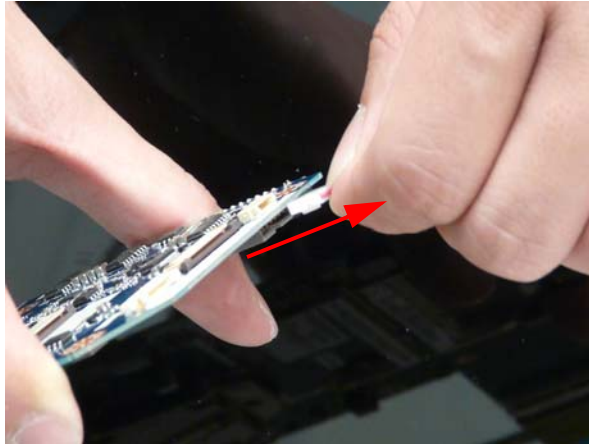

2. Reach under the mainboard to plug in the LVDS cable.

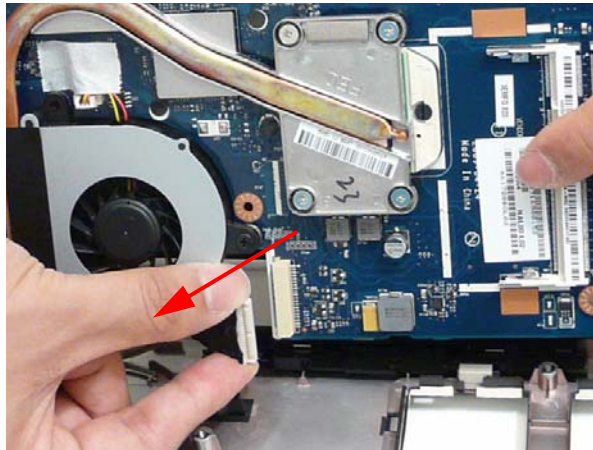

3. Insert the Mainboard right side first, aligning the I/O ports with the Lower Cover.

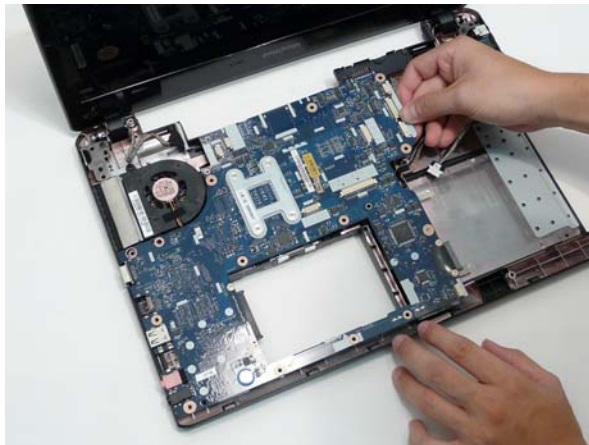

4. Insert the LVDS cable into the cable channel as shown.

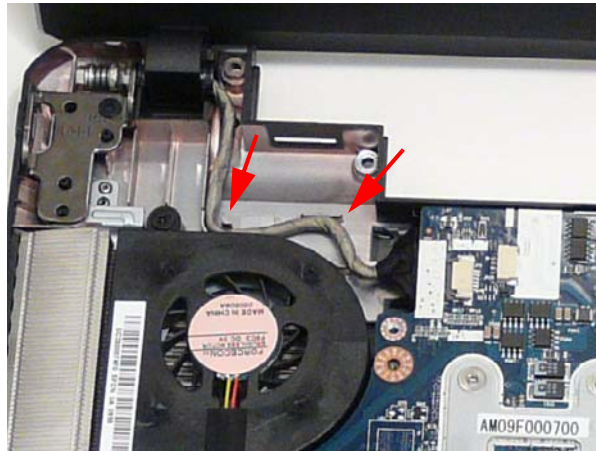

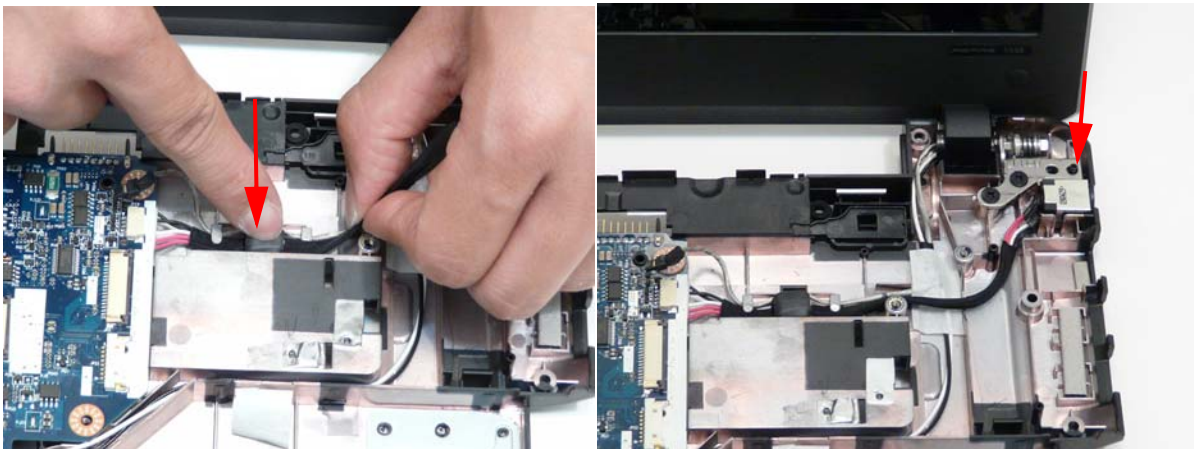

5. Insert the DC-In cable into the securing clips as shown.



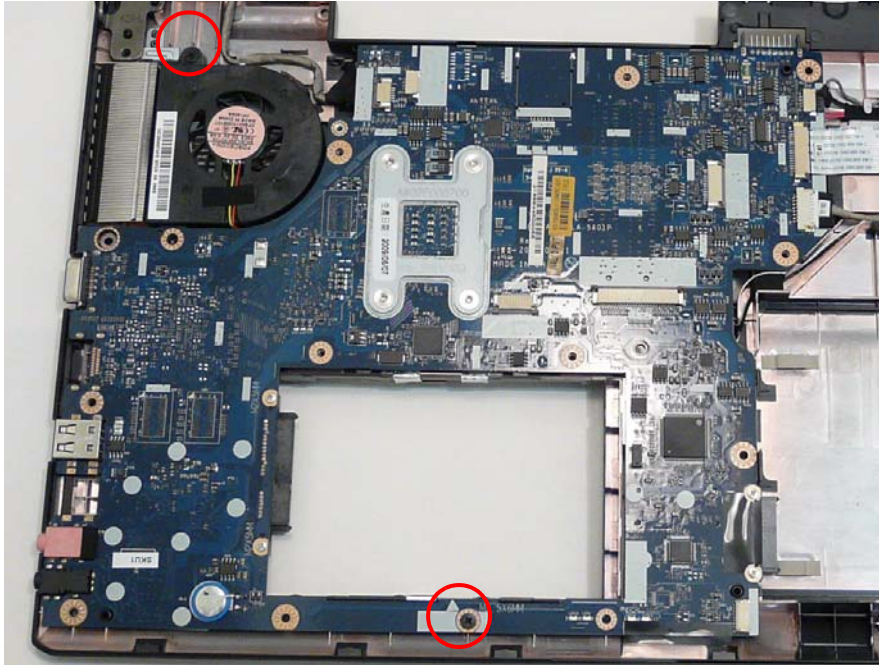

6. Insert the two screws securing the Mainboard and Fan to the Lower Cover as indicated.



Step	Size	Quantity	Screw Type
Mainboard	M2.5*5	2	

7. Connect the Microphone Cable to the Mainboard.

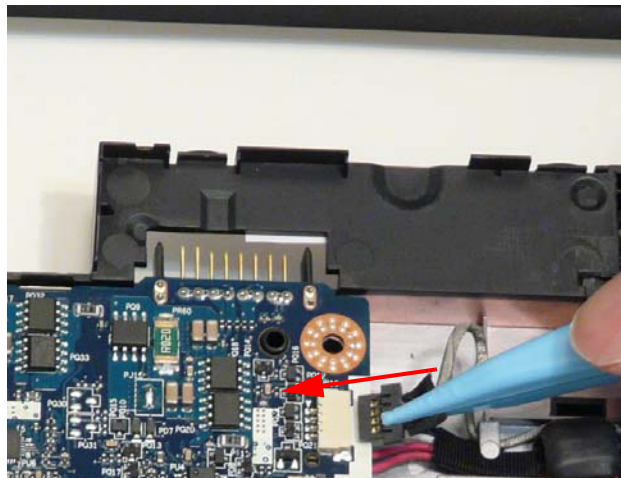

---

## Replacing the I/O Board

1. Connect the I/O Board Cable to the I/O Board.

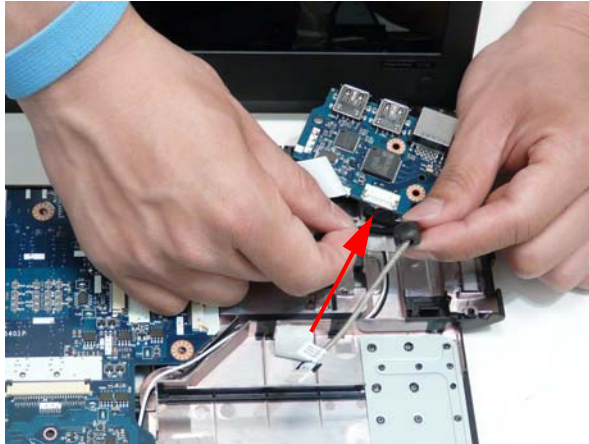

2. Apply the adhesive to secure the I/O Board cable to the Lower Cover.

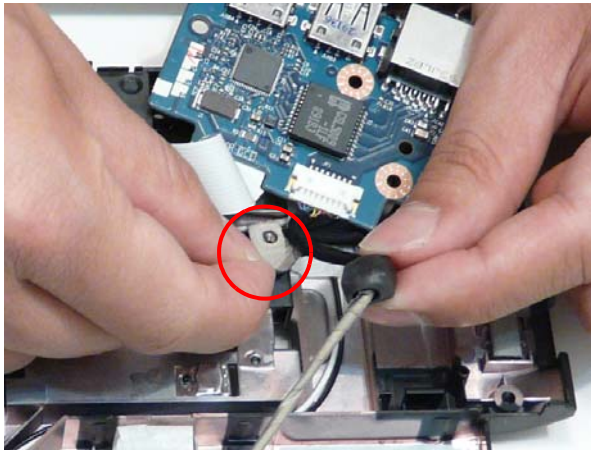

3. Insert the board into the lower cover so the white tab is under the securing clip in the lower cover, taking care to align the screw holes.

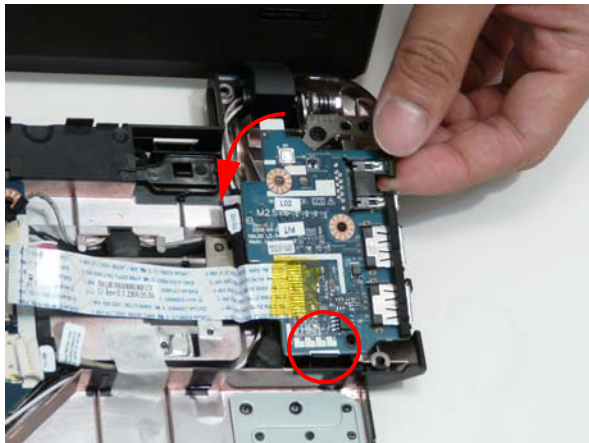

4. Insert the single screw to secure the I/O Board to the Lower Cover.



Step	Size	Quantity	Screw Type
I/O Board	M2.5*6	1	

5. Connect the cable to the Mainboard.





6. Connect the FFC to the Mainboard and close the locking latch.

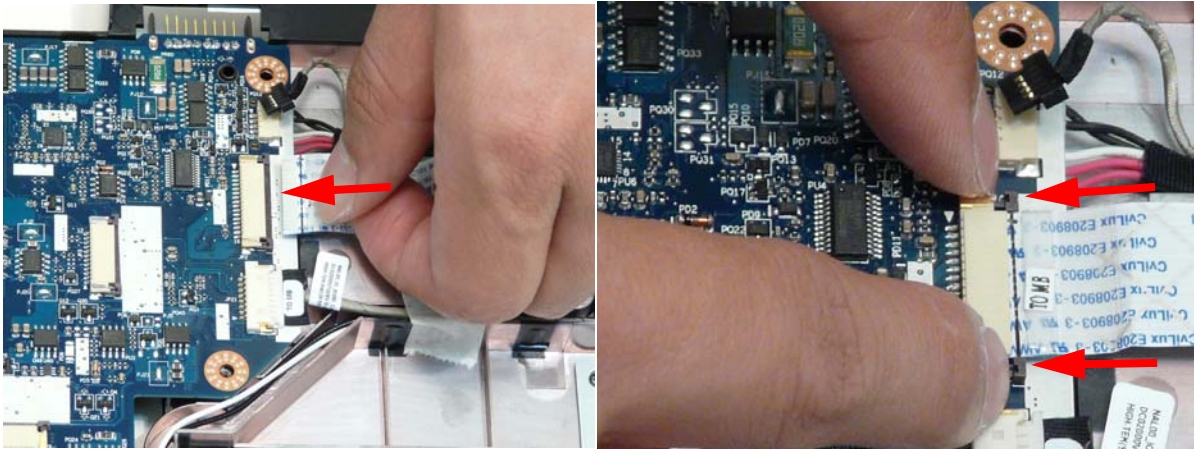

## Replacing the Media Board

1. Insert the Media Board FFC through the cover as shown.

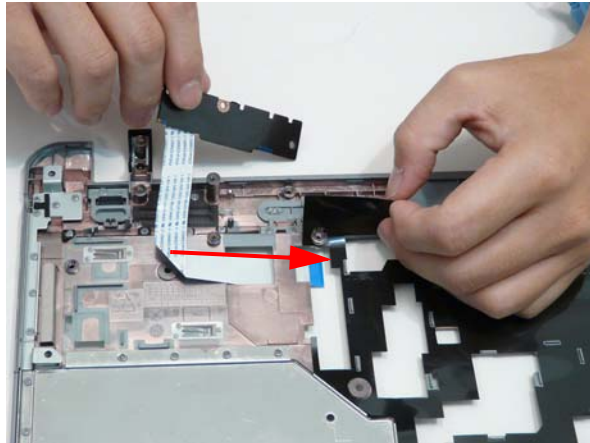

2. Holding the mylar back, insert the Media Board under the securing clips in the upper cover and place on the upper cover so the aligning pins are in the holes.

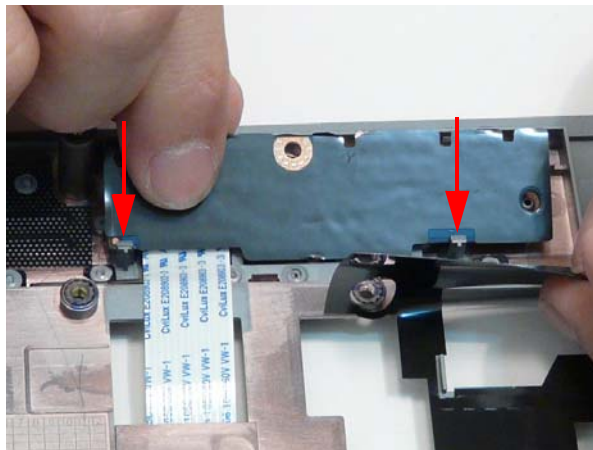

- Adhere the mylar to the Media Board and insert the single screw to secure the Media Board to the Lower Cover.

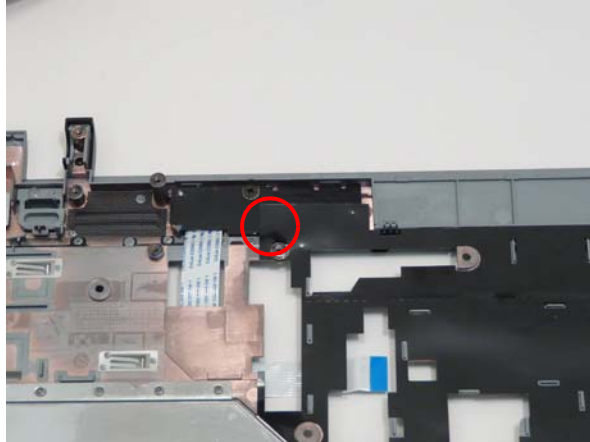

Step	Size	Quantity	Screw Type
Media Board	M2.5*3	1	

## Replacing the Speaker Modules

- Place the right side speaker onto the Lower Cover as shown.

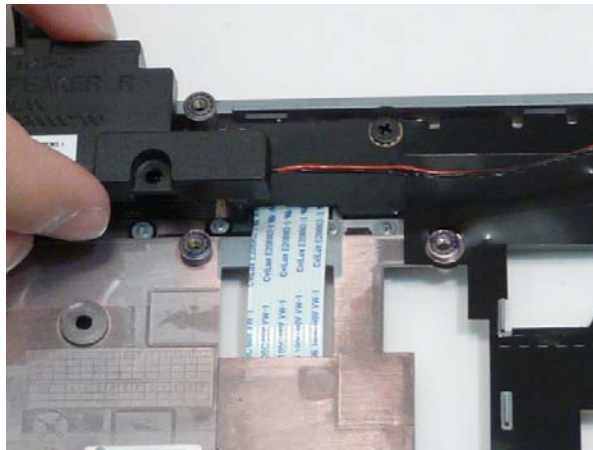

2. Place the right side speaker into the Lower Cover and peel back the mylar to expose the wire guides as shown.

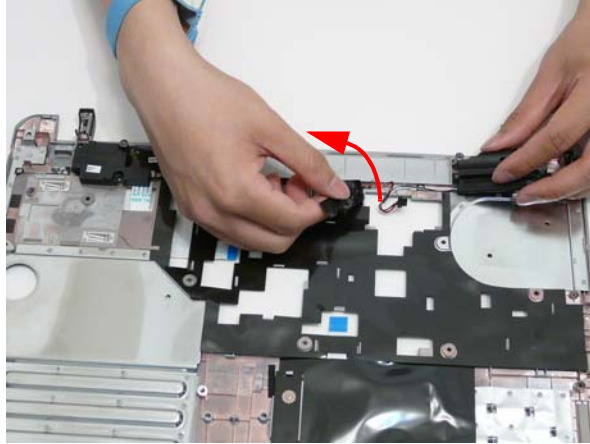

3. Peel back the mylar and insert the Speaker Cable into the cable channel. Ensure that the cable passes under all cable clips.

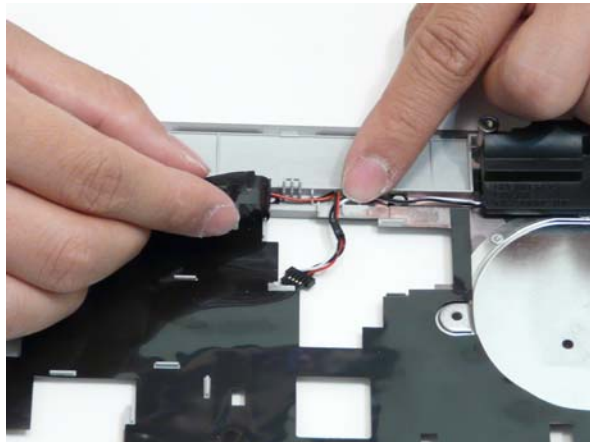
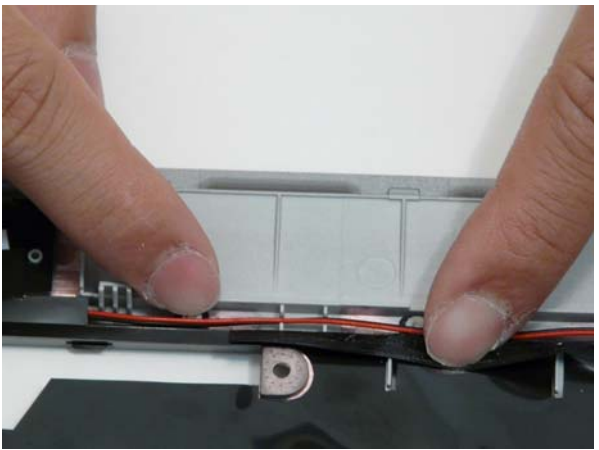
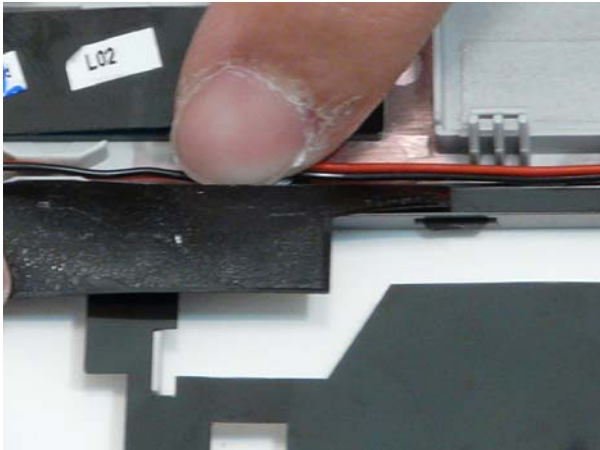

4. Insert the four screws to secure the Speakers to the Upper Cover.



Step	Size	Quantity	Screw Type
Speaker Module	M2.5*3	4	

## Replacing the Power Board

1. Insert the Power Board into the Lower Cover so the slot on the Power Board hooks onto the securing tab in the upper cover.

**IMPORTANT:**The FFC is soldered to the power board. Take care when lifting to minimize bending of the connection, lest breakage occur.

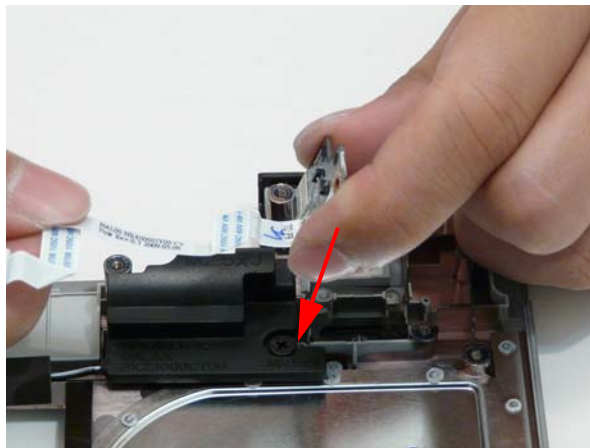



2. Adhere the FFC to the Speaker Module.



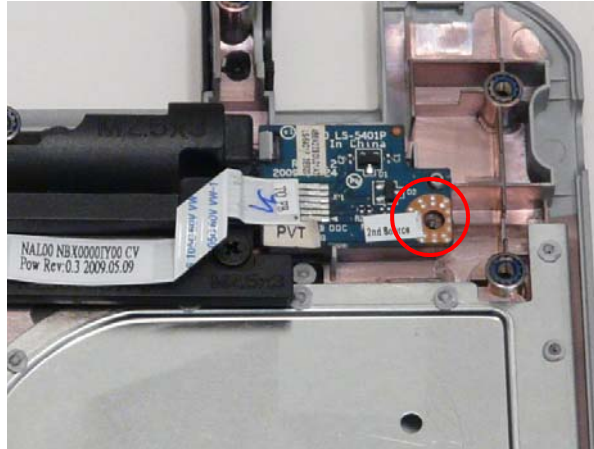

3. Insert the single screw to secure the Power Board to the Lower Cover.



Step	Size	Quantity	Screw Type
Power Board	M2.5*3	1	

## Replacing the Touchpad Bracket

1. Slide the Touchpad Bracket into the slots in the upper cover.

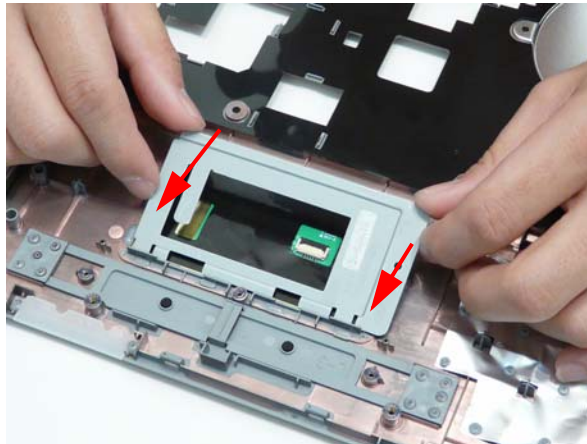



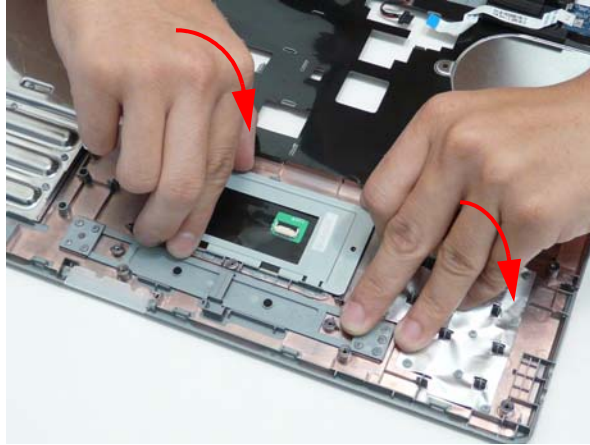

2. Push the bracket down until it is secured under the tabs along the top edge.

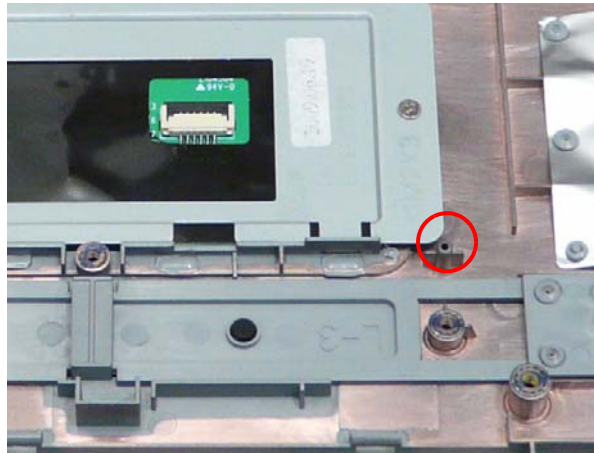

3. Insert the single screw to secure the Touchpad Bracket to the Upper Cover.



Step	Size	Quantity	Screw Type
TouchPad Bracket	M2*3	1	

# Replacing the Button Board

1. Insert the Mainboard FFC through the cover as shown.

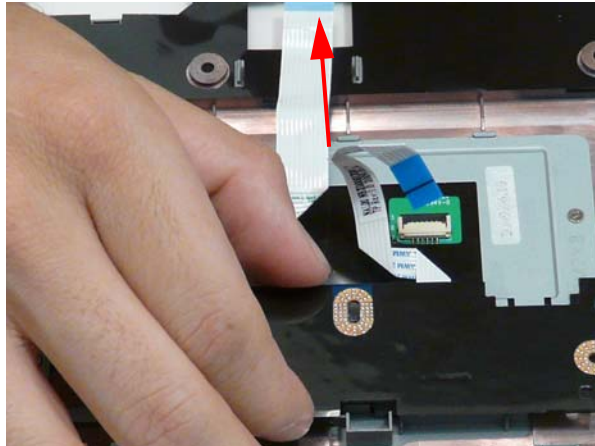

2. Replace the three screws to secure the button board to the Upper Cover.

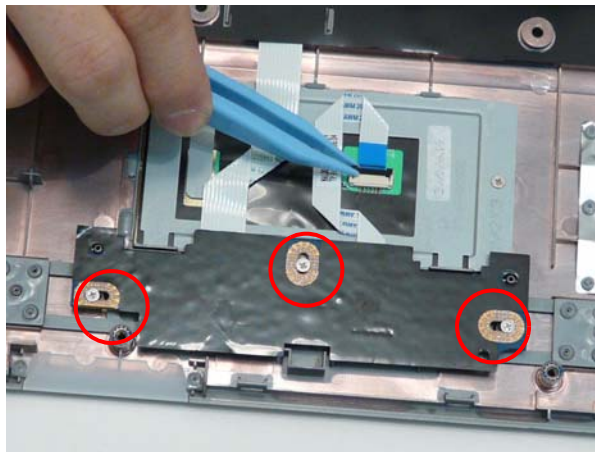

Step	Size	Quantity	Screw Type
Button Board	M2*3	4	

3. Slide the aminboard FFC through the cutout in the upper cover and adhere the FFCs to the upper cover.

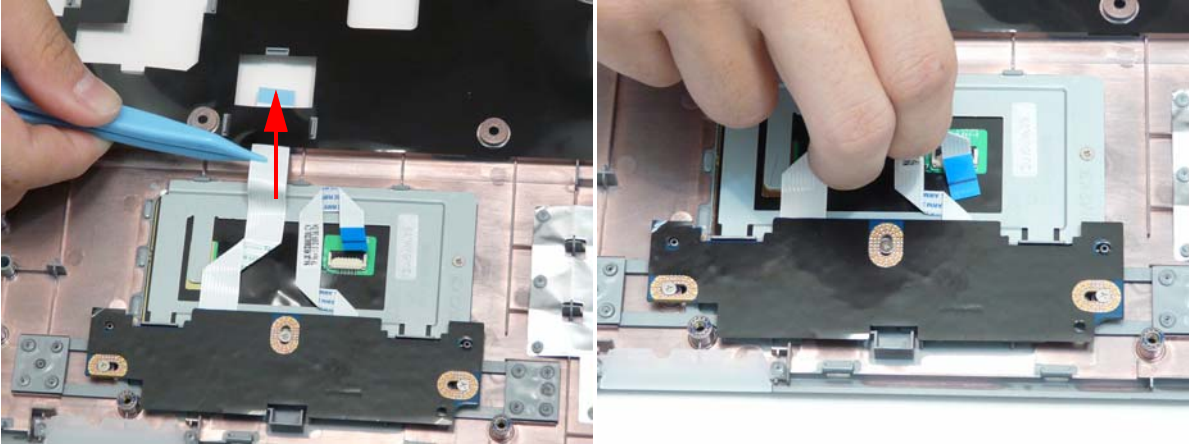

4. Connect the single FFC to the Touchpad and close the securing latch.

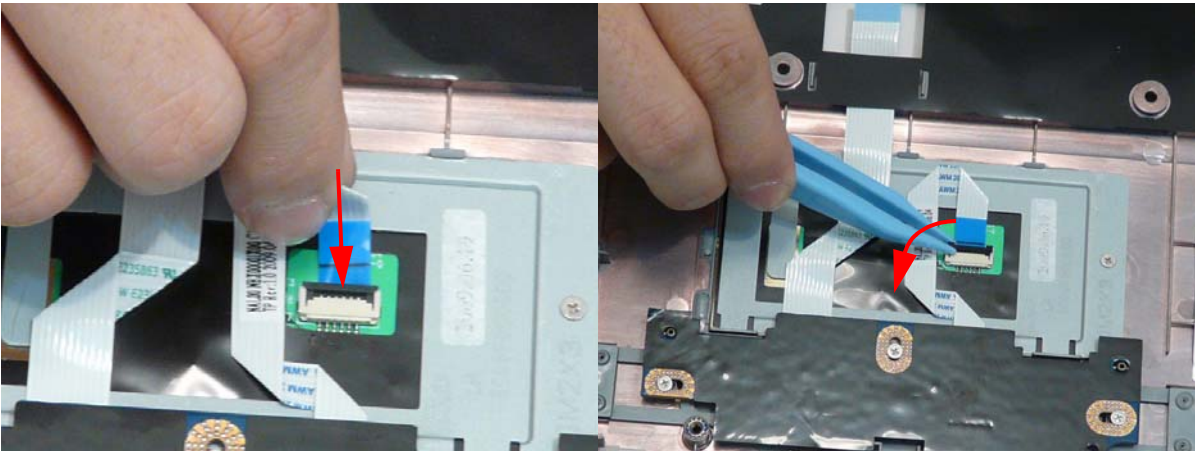

5. Replace the mylar sheet covering the Button Board.

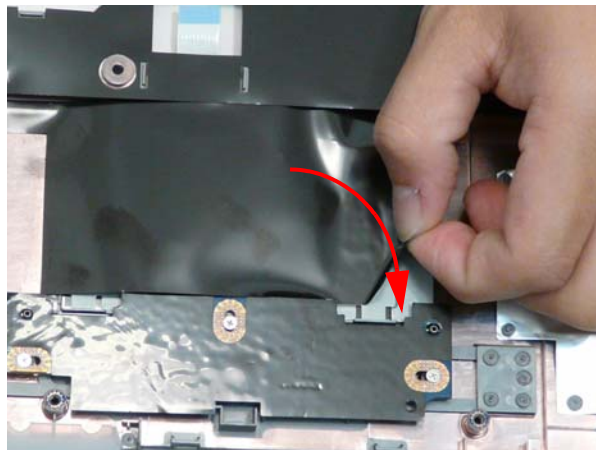

---

## Replacing the Upper Cover

1. Place the Upper Cover on the assembly bottom edge first.





2. Starting at the bottom edge, press the edges of the upper cover and lower cover together. An audible click signifies that the securing clips are engaged.



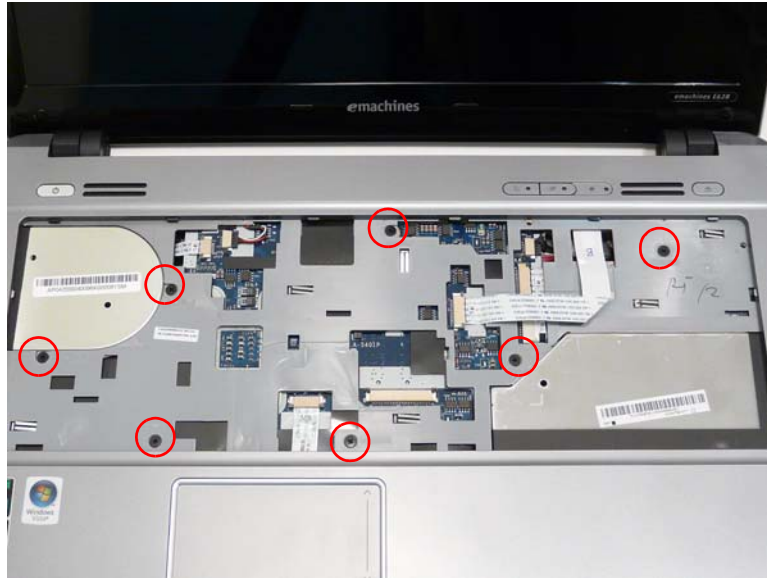

3. Insert the seven securing screws into the Upper Cover.



Step	Size	Quantity	Screw Type
Upper Cover	M2.5*6	7	

4. Turn the computer over and connect the following cables to the Mainboard:

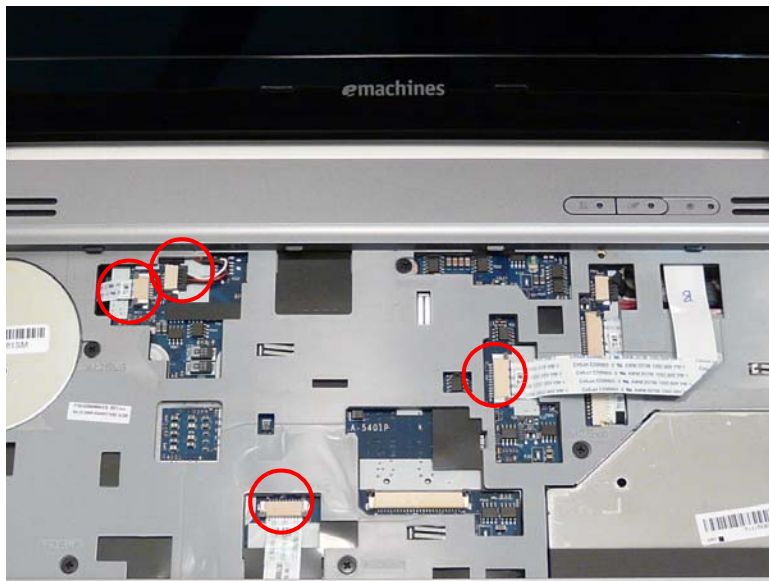

- a. Connect the Power Board FFC and close the locking latch as shown.

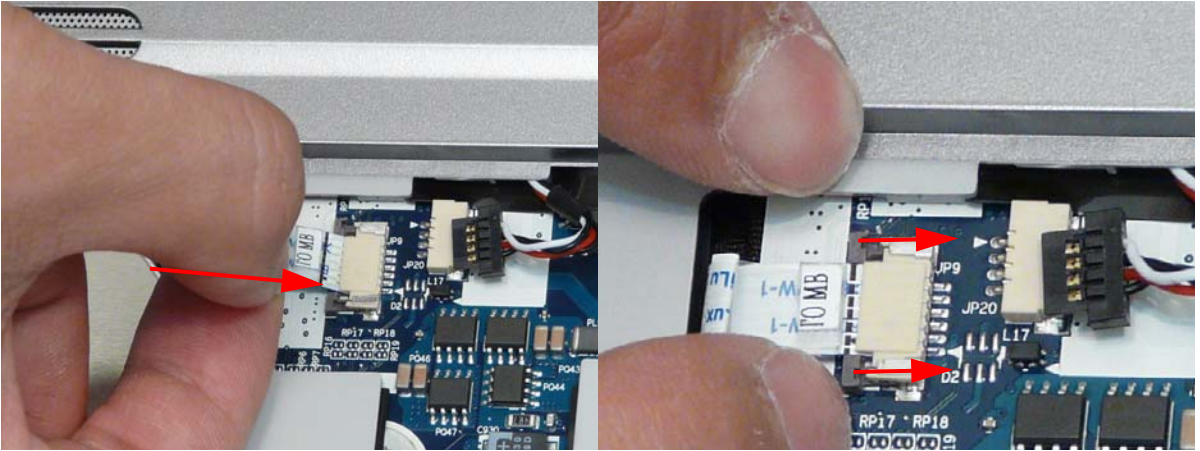

- b. Connect the Speaker Cable as shown.



- c. Connect the Button Board FFC and close the locking latch as shown.

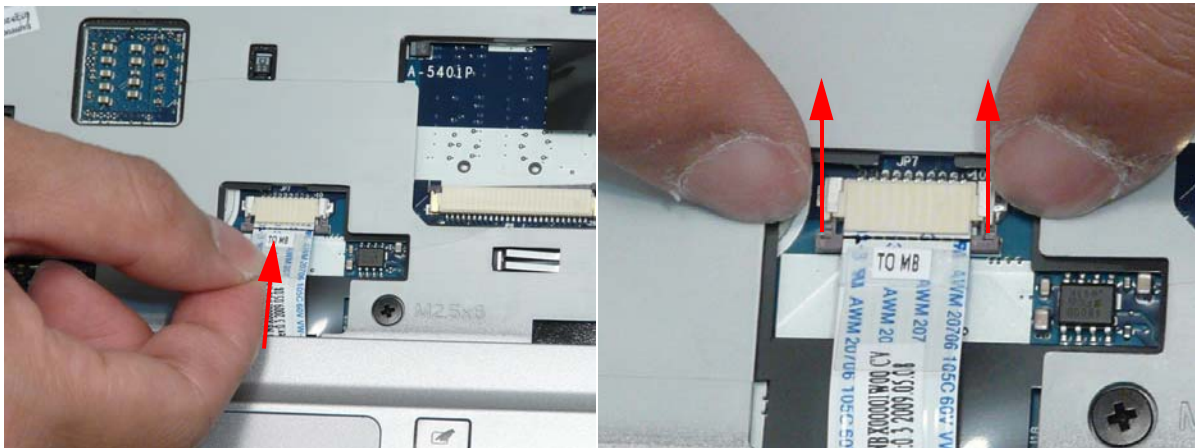

d. Connect the Media Board FFC and close the locking latch as shown.

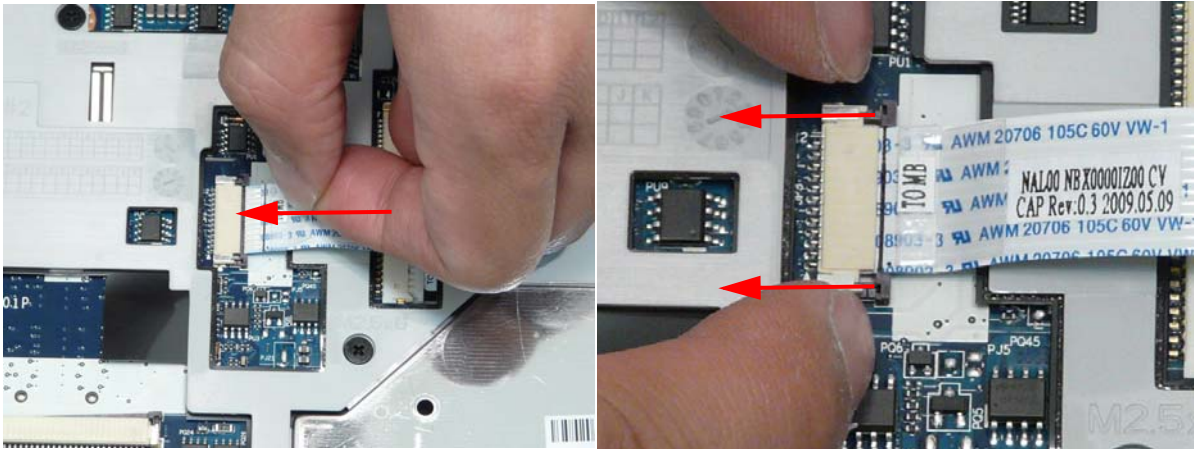

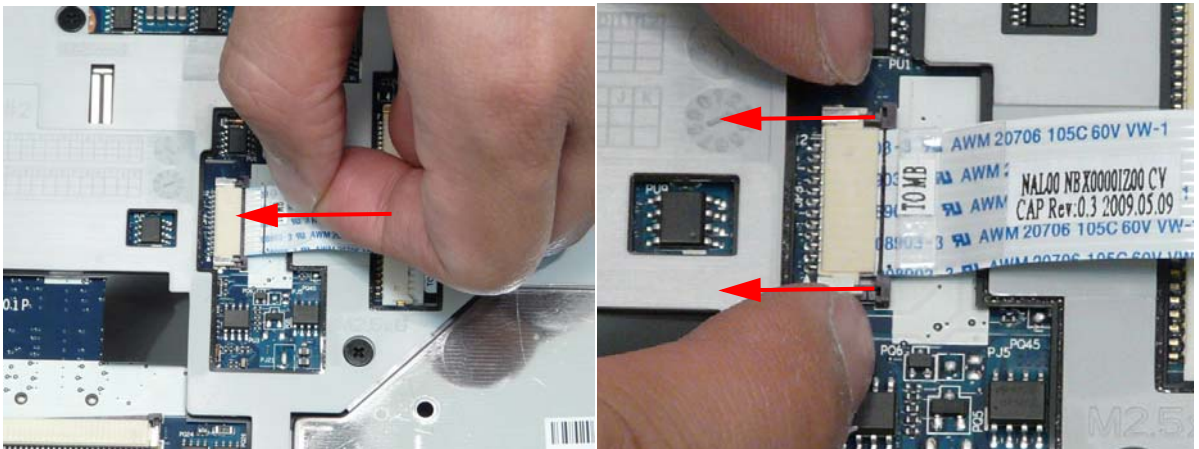

e. Connect the Media Board FFC and close the locking latch as shown.



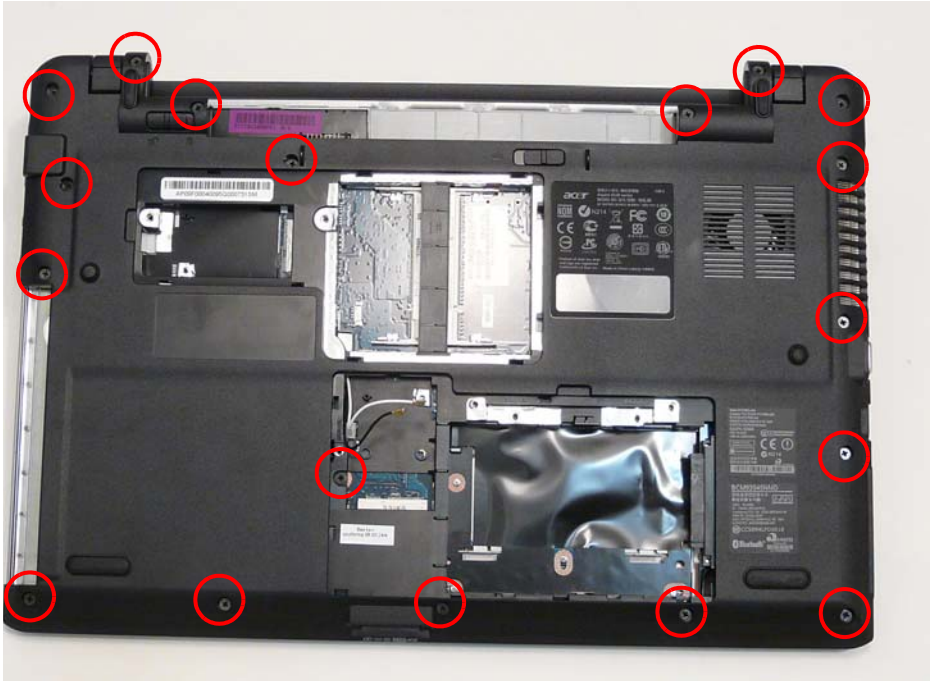

- Turn the computer over and insert the screws to secure the Upper Cover to the Lower Cover.



Step	Size	Quantity	Screw Type
Upper Cover	M2.5*8	18	

## Replacing the Keyboard

- Connect the FFC and close the Keyboard FFC securing latch as shown.

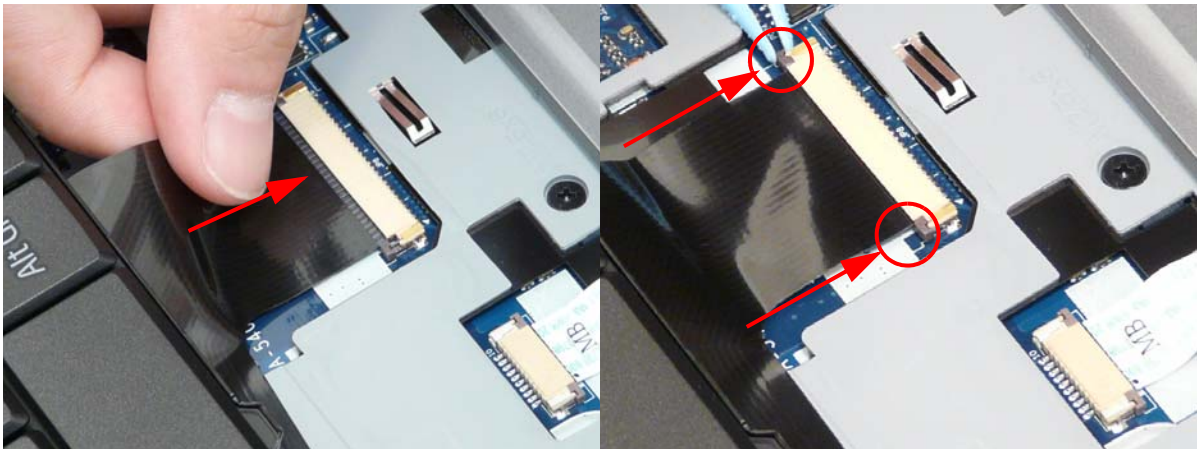

- 
2. Insert the keyboard so that the bottom tabs enter the slots in the upper cover.



3. Press down on the edges of the keyboard. An audible click indicates that the securing clips have engaged.

# External Module Reassembly Process

## Replacing the WLAN Board

1. Insert the WLAN Board into the Mainboard.

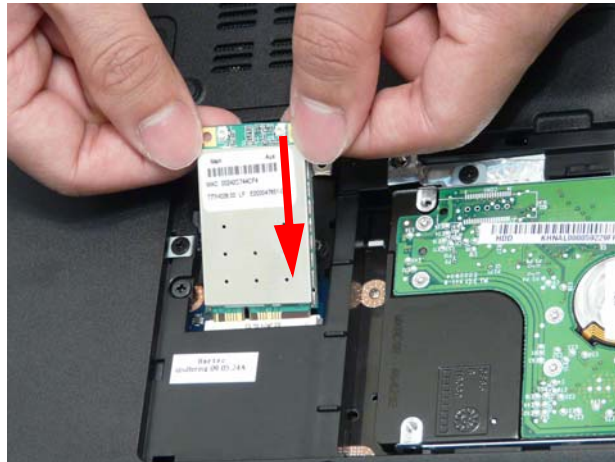

2. Insert the single screw to secure the WLAN Board in place.



Step	Size	Quantity	Screw Type
WLAN Board	M2*3	1	

3. Connect the Antenna cables to the WLAN Board.

**NOTE:** Cable placement is White to the AUX terminal (right) and Black to the MAIN terminal (left).

**IMPORTANT:** Ensure that the cables are tucked into the chassis to prevent them from being pinched when the lower covers are replaced.



## Replacing the DIMM Modules

1. Identify the SODIMM to replace. The image below shows the locations of SODIMM slot 0 and SODIMM slot 1. Slot 0 must be populated first when installing or replacing defective memory.

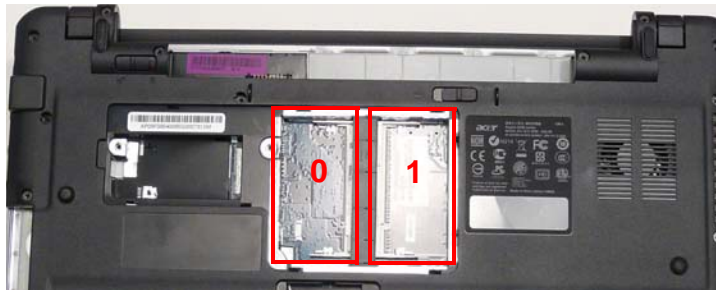

2. Insert a DIMM into Slot 0.

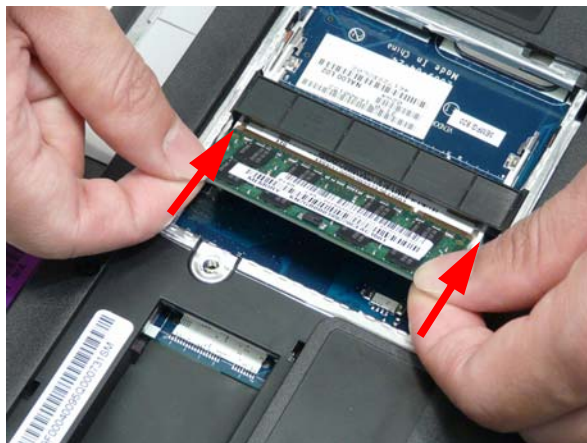



3. Press the DIMM down into the socket as shown. An audible click indicates the DIMM is properly installed.

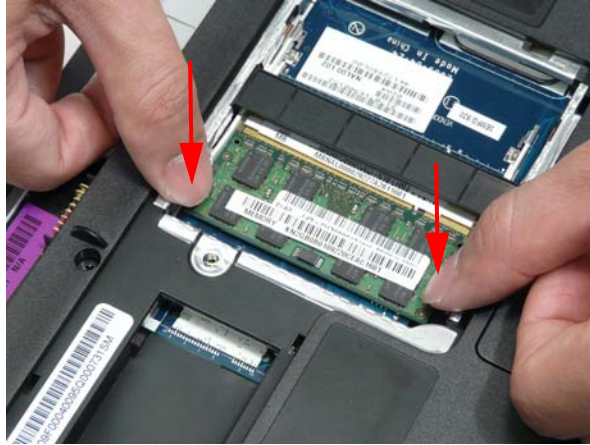

4. Insert a DIMM into Slot 1.



5. Press the DIMM down into the socket as shown. An audible click indicates the DIMM is properly installed.





# Replacing the Hard Disk Drive Module

1. Place the HDD into the carrier.

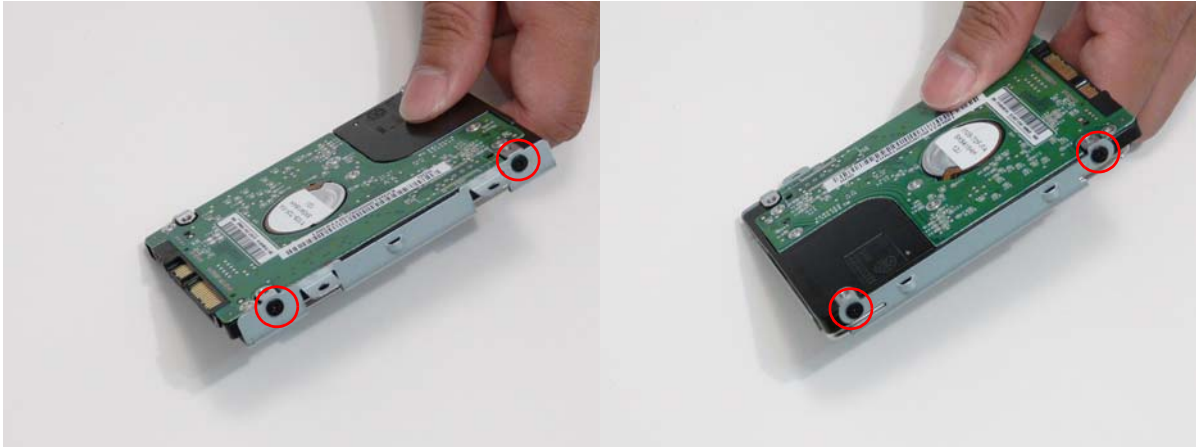

2. Insert the four screws (two each side) to secure the hard disk to the carrier. Carrier screw holes have been numbered 1-4. Insert the screws in numerical order: 1, 2, 3, 4.



Step	Size	Quantity	Screw Type
HDD Carrier	M3*3	4	

- Place the hard disk drive module into the bay.



- Slide the HDD in the direction of the arrow to connect the HDD to the SATA interface connector.



- Insert the two screws to secure the HDD Module in place.



Step	Size	Quantity	Screw Type
HDD Module	M2.5*4	2	



# Replacing the ODD

1. Insert the hook on the ODD bezel as shown.

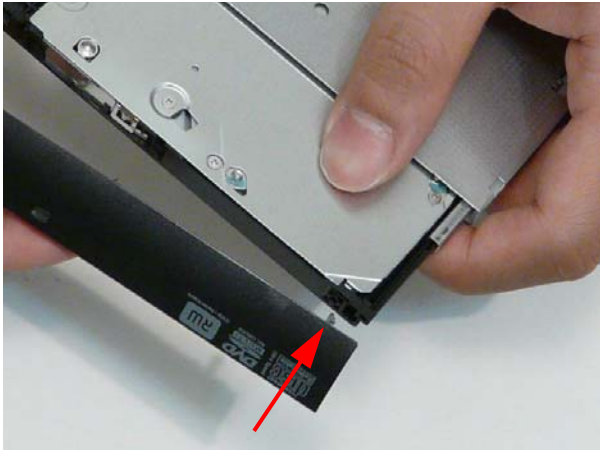

2. Slide the securing clip of the ODD bezel into the slot on the ODD module. An audible click indicates the hook has engaged.



3. Insert the two screws to secure the ODD bracket in place.



Step	Size	Quantity	Screw Type
ODD Bracket	M2*3	2	

- Slide the ODD module into the assembly

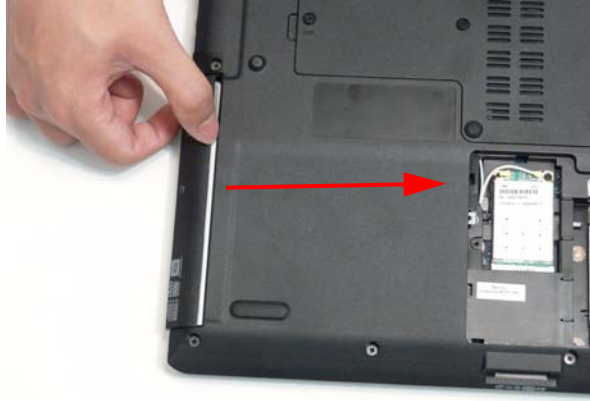

- Insert the screw to secure the ODD module.



Step	Size	Quantity	Screw Type
ODD Module	M2.5*3	1	

---

## Replacing the Lower Covers

1. Place the HDD cover over the HDD bay. Press until the six tabs in the door engage.



2. Tighten the two captive screws in the HDD Cover.



3. Place the Memory Cover on the memory bay.



4. Press down until the seven clips in the cover snap into place.

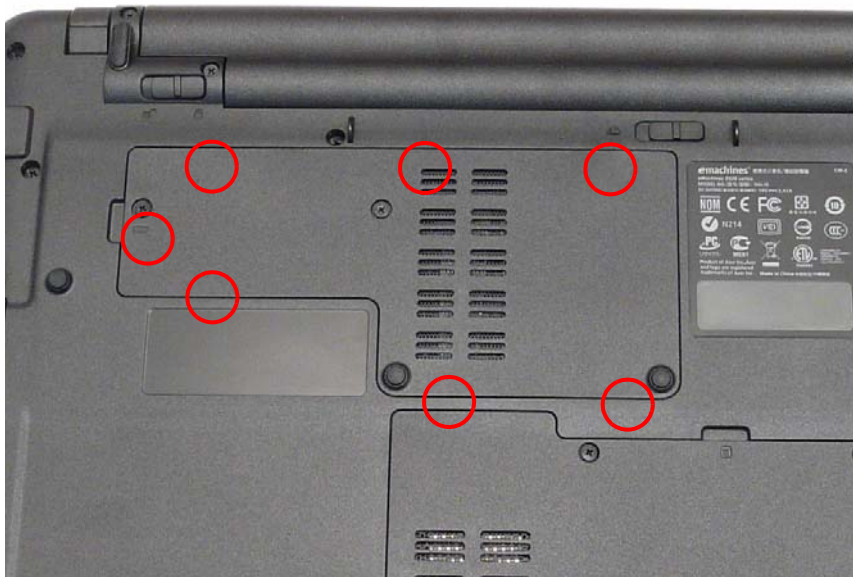

- 
5. Tighten the two captive screws in the Memory Cover.



## Replacing the Battery

1. Slide the battery into the battery bay as shown.



- 
2. Slide the battery lock/unlock latch to the lock position.







# Troubleshooting

---

## Common Problems

Use the following procedure as a guide for computer problems.

**NOTE:** The diagnostic tests are intended to test only Acer products. Non-Acer products, prototype cards, or modified options can give false errors and invalid system responses.

1. Obtain the failing symptoms in as much detail as possible.
2. Verify the symptoms by attempting to re-create the failure by running the diagnostic test or by repeating the same operation.
3. Use the following table with the verified symptom to determine which page to go to.

Symptoms (Verified)	Go To
Power On Issue	Page 149
No Display Issue	Page 150
LCD Failure	Page 152
Internal Keyboard Failure	Page 152
Touchpad Failure	Page 153
Internal Speaker Failure	Page 153
Internal Microphone Failure	Page 155
ODD Failure	Page 157
Rightside USB Failure	Page 160
Modem Failure	Page 161
WLAN/WiMAX Failure	Page 161
Bluetooth Failure	Page 162
Function Button Failure	Page 162
Thermal Unit Failure	Page 163
Other Functions Failure	Page 164
Intermittent Failures	Page 164
Undetermined Failures	Page 165

4. If the Issue is still not resolved, see "Online Support Information" on page 191.

---

## Power On Issue

If the system doesn't power on, perform the following actions one at a time to correct the problem. Do not replace a non-defective FRUs:

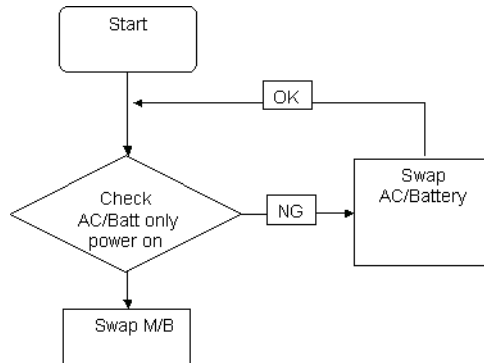

## Computer Shutdown Intermittently

If the system powers off at intervals, perform the following actions one at a time to correct the problem.

1. Check the power cable is properly connected to the computer and the electrical outlet.
2. Remove any extension cables between the computer and the outlet.
3. Remove any surge protectors between the computer and the electrical outlet. Plug the computer directly into a known good electrical outlet.
4. Disconnect the power and open the casing to check the Thermal Unit and fan airways are free of obstructions.
5. Remove all external and non-essential hardware connected to the computer that are not necessary to boot the computer to the failure point.
6. Remove any recently installed software.
7. If the Issue is still not resolved, see "Online Support Information" on page 191.

# No Display Issue

If the **Display** doesn't work, perform the following actions one at a time to correct the problem. Do not replace a non-defective FRUs:

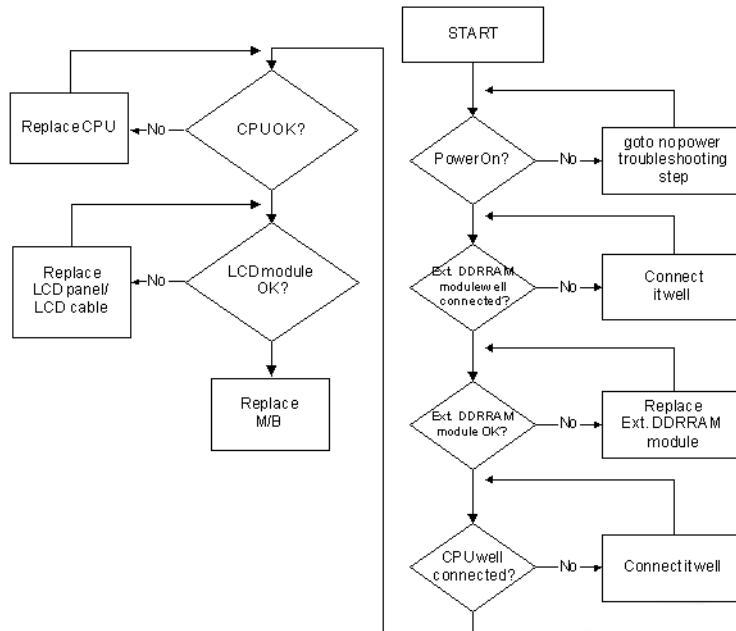

## No POST or Video

If the POST or video doesn't display, perform the following actions one at a time to correct the problem.

1. Make sure that the internal display is selected. On this notebook model, switching between the internal display and the external display is done by pressing **Fn+F5**. Reference Product pages for specific model procedures.
2. Make sure the computer has power by checking at least one of the following occurs:
  - Fans start up
  - Status LEDs light up

If there is no power, see "Power On Issue" on page 149.

3. Drain any stored power by removing the power cable and battery and holding down the power button for 10 seconds. Reconnect the power and reboot the computer.
4. Connect an external monitor to the computer and switch between the internal display and the external display is by pressing **Fn+F5** (on this model).

If the POST or video appears on the external display, see "LCD Failure" on page 152.

5. Disconnect power and all external devices including port replicators or docking stations. Remove any memory cards and CD/DVD discs. Restart the computer.

If the computer boots correctly, add the devices one by one until the failure point is discovered.

6. Reseat the memory modules.
7. Remove the drives (see "Disassembly Process" on page 52).
8. If the Issue is still not resolved, see "Online Support Information" on page 191.

---

## Abnormal Video Display

If video displays abnormally, perform the following actions one at a time to correct the problem.

1. Reboot the computer.
2. If permanent vertical/horizontal lines or dark spots display in the same location, the LCD is faulty and should be replaced. See “Disassembly Process” on page 52.
3. If extensive pixel damage is present (different colored spots in the same locations on the screen), the LCD is faulty and should be replaced. See “Disassembly Process” on page 52.
4. Adjust the brightness to its highest level. See the User Manual for instructions on adjusting settings.  
**NOTE:** Ensure that the computer is not running on battery alone as this may reduce display brightness.  
If the display is too dim at the highest brightness setting, the LCD is faulty and should be replaced. See “Disassembly Process” on page 52.
5. Check the display resolution is correctly configured:
  - a. Minimize or close all Windows.
  - b. If display size is only abnormal in an application, check the view settings and control/mouse wheel zoom feature in the application.
  - c. If desktop display resolution is not normal, right-click on the desktop and select **Personalize**→ **Display Settings**.
  - d. Click and drag the Resolution slider to the desired resolution.
  - e. Click **Apply** and check the display. Readjust if necessary.
6. Roll back the video driver to the previous version if updated.
7. Remove and reinstall the video driver.
8. Check the Device Manager to determine that:
  - The device is properly installed. There are no red Xs or yellow exclamation marks.
  - There are no device conflicts.
  - No hardware is listed under Other Devices.
9. If the Issue is still not resolved, see “Online Support Information” on page 191.
10. Run the Windows Memory Diagnostic from the operating system DVD and follow the onscreen prompts.
11. If the Issue is still not resolved, see “Online Support Information” on page 191.

## Random Loss of BIOS Settings

If the computer is experiencing intermittent loss of BIOS information, perform the following actions one at a time to correct the problem.

1. If the computer is more than one year old, replace the CMOS battery.
2. Run a complete virus scan using up-to-date software to ensure the computer is virus free.
3. If the computer is experiencing HDD or ODD BIOS information loss, disconnect and reconnect the power and data cables between devices.  
If the BIOS settings are still lost, replace the cables.
4. If HDD information is missing from the BIOS, the drive may be defective and should be replaced.
5. Replace the Motherboard.
6. If the Issue is still not resolved, see “Online Support Information” on page 191.

---

## LCD Failure

If the **LCD** fails, perform the following actions one at a time to correct the problem. Do not replace a non-defective FRUs:

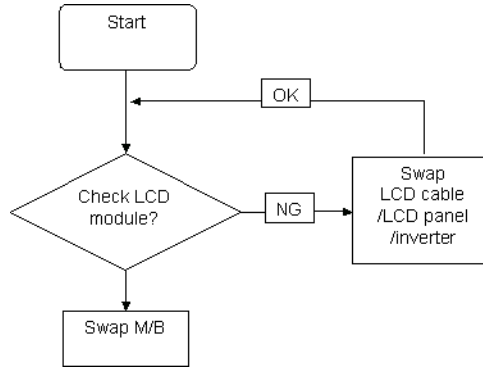

## Built-In Keyboard Failure

If the built-in **Keyboard** fails, perform the following actions one at a time to correct the problem. Do not replace a non-defective FRUs:

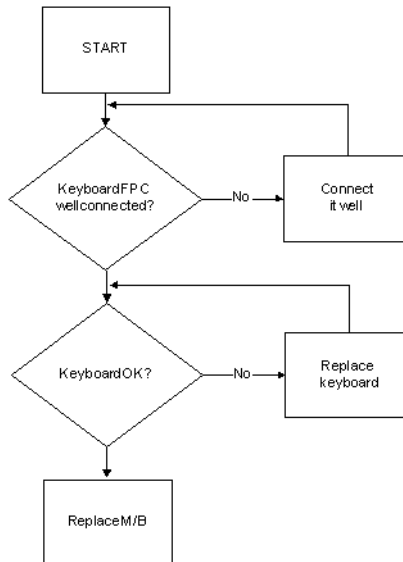

# Touchpad Failure

If the **Touchpad** doesn't work, perform the following actions one at a time to correct the problem. Do not replace a non-defective FRUs:

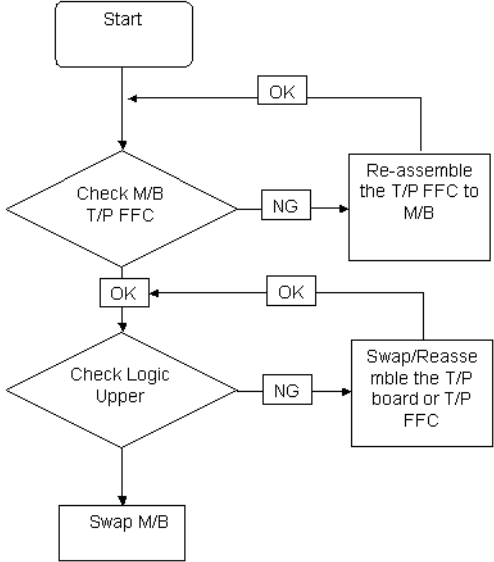

# Internal Speaker Failure

If the internal **Speakers** fail, perform the following actions one at a time to correct the problem. Do not replace a non-defective FRUs:

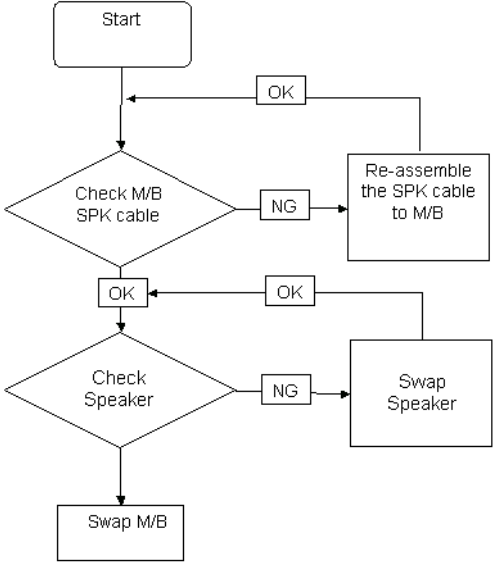

---

## Sound Problems

If sound problems are experienced, perform the following actions one at a time to correct the problem.

1. Reboot the computer.
2. Navigate to **Start** → **Control Panel** → **System and Maintenance** → **System** → **Device Manager**. Check the Device Manager to determine that:
  - The device is properly installed.
  - There are no red Xs or yellow exclamation marks.
  - There are no device conflicts.
  - No hardware is listed under Other Devices.
3. Roll back the audio driver to the previous version, if updated recently.
4. Remove and reinstall the audio driver.
5. Ensure that all volume controls are set mid range:
  - a. Click the volume icon on the taskbar and drag the slider to 50. Ensure that the volume is not muted.
  - b. Click Mixer to verify that other audio applications are set to 50 and not muted.
6. Navigate to **Start** → **Control Panel** → **Hardware and Sound** → **Sound**. Ensure that Speakers are selected as the default audio device (green check mark).

**NOTE:** If Speakers does not show, right-click on the **Playback** tab and select **Show Disabled Devices** (clear by default).
7. Select Speakers and click **Configure** to start **Speaker Setup**. Follow the onscreen prompts to configure the speakers.
8. Remove and recently installed hardware or software.
9. Restore system and file settings from a known good date using **System Restore**.

If the issue is not fixed, repeat the preceding steps and select an earlier time and date.
10. Reinstall the Operating System.
11. If the Issue is still not resolved, see “Online Support Information” on page 191.



---

# Internal Microphone Failure

If the internal **Microphone** fails, perform the following actions one at a time to correct the problem. Do not replace a non-defective FRUs:

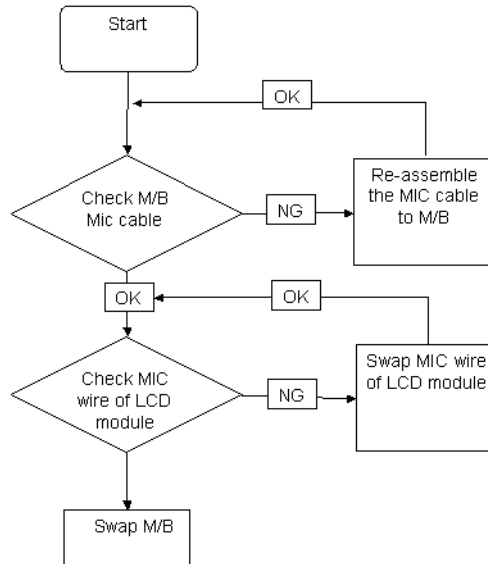

## Microphone Problems

If internal or external **Microphones** do not operate correctly, perform the following actions one at a time to correct the problem.

1. Check that the microphone is enabled. Navigate to **Start** → **Control Panel** → **Hardware and Sound** → **Sound** and select the **Recording** tab.
2. Right-click on the **Recording** tab and select **Show Disabled Devices** (clear by default).
3. The microphone appears on the **Recording** tab.
4. Right-click on the microphone and select **Enable**.
5. Select the microphone then click **Properties**. Select the **Levels** tab.
6. Increase the volume to the maximum setting and click **OK**.
7. Test the microphone hardware:
  - a. Select the microphone and click **Configure**.
  - b. Select **Set up microphone**.
  - c. Select the microphone type from the list and click **Next**.
  - d. Follow the onscreen prompts to complete the test.
8. If the Issue is still not resolved, see "Online Support Information" on page 191.

---

## HDD Not Operating Correctly

If the **HDD** does not operate correctly, perform the following actions one at a time to correct the problem.

1. Disconnect all external devices.
2. Run a complete virus scan using up-to-date software to ensure the computer is virus free.
3. Run the Windows Vista Startup Repair Utility:
  - a. insert the Windows Vista Operating System DVD in the ODD and restart the computer.
  - b. When prompted, press any key to start to the operating system DVD.
  - c. The **Install Windows** screen displays. Click **Next**.
  - d. Select **Repair your computer**.
  - e. The **System Recovery Options** screen displays. Click **Next**.
  - f. Select the appropriate operating system, and click **Next**.

**NOTE:** Click **Load Drivers** if controller drives are required.

- g. Select **Startup Repair**.
- h. Startup Repair attempts to locate and resolve issues with the computer.
- i. When complete, click **Finish**.

If an issue is discovered, follow the onscreen information to resolve the problem.

4. Run the Windows Memory Diagnostic Tool. For more information see Windows Help and Support.
5. Restart the computer and press F2 to enter the BIOS Utility. Check the BIOS settings are correct and that CD/DVD drive is set as the first boot device on the Boot menu.
6. Ensure all cables and jumpers on the HDD and ODD are set correctly.
7. Remove any recently added hardware and associated software.
8. Run the Windows Disk Defragmenter. For more information see Windows Help and Support.
9. Run Windows Check Disk by entering **chkdsk /r** from a command prompt. For more information see Windows Help and Support.
10. Restore system and file settings from a known good date using **System Restore**.

If the issue is not fixed, repeat the preceding steps and select an earlier time and date.
11. Replace the HDD. See "Disassembly Process" on page 52.

---

## ODD Failure

If the **ODD** fails, perform the following actions one at a time to correct the problem. Do not replace a non-defective FRUs:

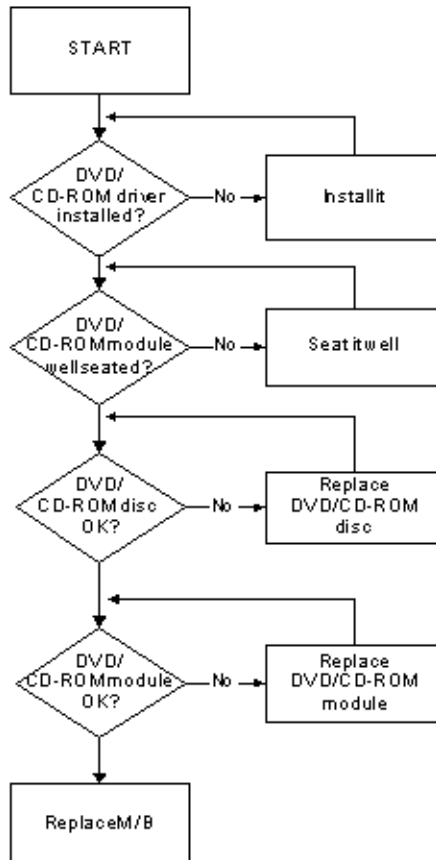

## ODD Not Operating Correctly

If the **ODD** exhibits any of the following symptoms it may be faulty:

- Audio CDs do not play when loaded
- DVDs do not play when loaded
- Blank discs do not burn correctly
- DVD or CD play breaks up or jumps
- Optical drive not found or not active:
  - Not shown in My Computer or the BIOS setup
  - LED does not flash when the computer starts up
  - The tray does not eject
- Access failure screen displays
- The ODD is noisy

Perform the following general solutions one at a time to correct the problem.

1. Reboot the computer and retry the operation.
2. Try an alternate disc.
3. Navigate to **Start** → **Computer**. Check that the ODD device is displayed in the **Devices with Removable Storage** panel.

- 
4. Navigate to **Start** → **Control Panel** → **System and Maintenance** → **System** → **Device Manager**.
    - a. Double-click **IDE ATA/ATAPI controllers**. If a device displays a down arrow, right-click on the device and click **Enable**.
    - b. Double-click **DVD/CD-ROM drives**. If the device displays a down arrow, right-click on the device and click **Enable**.
    - c. Check that there are no yellow exclamation marks against the items in **IDE ATA/ATAPI controllers**. If a device has an exclamation mark, right-click on the device and uninstall and reinstall the driver.
    - d. Check that there are no yellow exclamation marks against the items in **DVD/CD-ROM drives**. If a device has an exclamation mark, right-click on the device and uninstall and reinstall the driver.
    - e. If the exclamation marker is not removed from the item in the lists, try removing any recently installed software and retrying the operation.

### Discs Do Not Play

If discs do not play when inserted in the drive, perform the following actions one at a time to correct the problem.

1. Check that the disc is correctly seated in the drive tray and that the label on the disc is visible.
2. Check that the media is clean and scratch free.
3. Try an alternate disc in the drive.
4. Ensure that **AutoPlay** is enabled:
  - a. Navigate to **Start** → **Control Panel** → **Hardware and Sound** → **AutoPlay**.
  - b. Select **Use AutoPlay for all media and devices**.
  - c. In the Audio CD and DVD Movie fields, select the desired player from the drop down menu.
5. Check that the Regional Code is correct for the selected media:

**IMPORTANT:**Region can only be changed a limited number of times. After Changes remaining reaches zero, the region cannot be changed even Windows is reinstalled or the drive is moved to another computer.

- a. Navigate to **Start** → **Control Panel** → **System and Maintenance** → **System** → **Device Manager**.
- b. Double-click **DVD/CD-ROM drives**.
- c. Right-click **DVD drive** and click **Properties**, then click the **DVD Region** tab.
- d. Select the region suitable for the media inserted in the drive.

### Discs Do Not Burn Properly

If discs can not be burned, perform the following actions one at a time to correct the problem.

1. Ensure that the default drive is record enabled:
  - a. Navigate to **Start** → **Computer** and right-click the writable ODD icon. Click **Properties**.
  - b. Select the **Recording** tab. In the **Desktop disc recording** panel, select the writable ODD from the drop down list.
  - c. Click **OK**.
2. Ensure that the software used for burning discs is the factory default. If using different software, refer to the software's user manual.

### Playback is Choppy

If playback is choppy or jumps, perform the following actions one at a time to correct the problem.

1. Check that system resources are not running low:
  - a. Try closing some applications.
  - b. Reboot and try the operation again.
2. Check that the ODD controller transfer mode is set to DMA:

- 
- a. Navigate to **Start** → **Control Panel** → **System and Maintenance** → **System** → **Device Manager**.
  - b. Double-click **IDE ATA/ATAPI controllers**, then right-click ATA Device 0.
  - c. Click **Properties** and select the **Advanced Settings** tab. Ensure that the **Enable DMA** box is checked and click **OK**.
  - d. Repeat for the other ATA Devices shown if applicable.

### Drive Not Detected

If Windows cannot detect the drive, perform the following actions one at a time to correct the problem.

1. Restart the computer and press F2 to enter the BIOS Utility.
2. Check that the drive is detected in the **ATAPI Model Name** field on the Information page.  
**NOTE:** Check that the entry is identical to one of the ODDs specified in “Hardware Specifications and Configurations” on page 18.
3. Turn off the power and remove the cover to inspect the connections to the ODD. See “Disassembly Process” on page 52.
  - a. Check for broken connectors on the drive, motherboard, and cables.
  - b. Check for bent or broken pins on the drive, motherboard, and cable connections.
  - c. Try an alternate cable, if available. If the drive works with the new cable, the original cable should be replaced.
4. Reseat the drive ensuring and all cables are connected correctly.
5. Replace the ODD. See “Disassembly Process” on page 52.

### Drive Read Failure

If discs cannot be read when inserted in the drive, perform the following actions one at a time to correct the problem.

1. Remove and clean the failed disc.
2. Retry reading the CD or DVD.
  - d. Test the drive using other discs.
  - e. Play a DVD movie
  - f. Listen to a music CD

If the ODD works properly with alternate discs, the original disc is probably defective and should be replaced.

3. Turn off the power and remove the cover to inspect the connections to the ODD. See “Disassembly Process” on page 52.
  - a. Check for broken connectors on the drive, motherboard, and cables.
  - b. Check for bent or broken pins on the drive, motherboard, and cable connections.
  - c. Try an alternate cable, if available. If the drive works with the new cable, the original cable should be replaced.
4. Replace the ODD. See “Disassembly Process” on page 52.

# USB Failure (Right side)

If the rightside **USB** port fails, perform the following actions one at a time to correct the problem. Do not replace a non-defective FRUs:

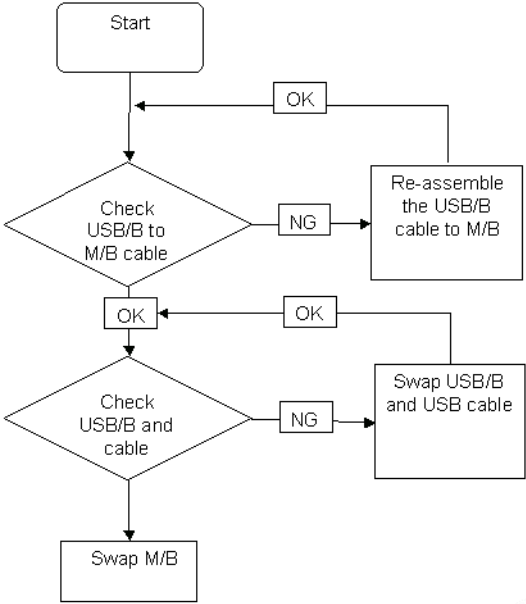

# Wireless Function Failure

If the **WLAN/WiMAX** fails, perform the following actions one at a time to correct the problem. Do not replace a non-defective FRUs:

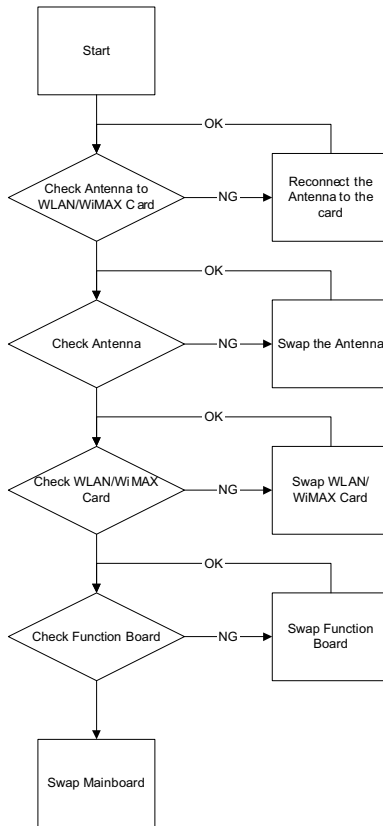



# Bluetooth Function Failure

If the **Bluetooth** fails, perform the following actions one at a time to correct the problem. Do not replace a non-defective FRUs:

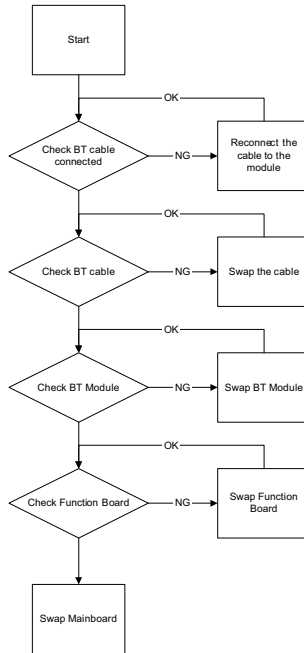

# Easy Button Failure

If the **Media Board** fails, perform the following actions one at a time to correct the problem. Do not replace a non-defective FRUs:

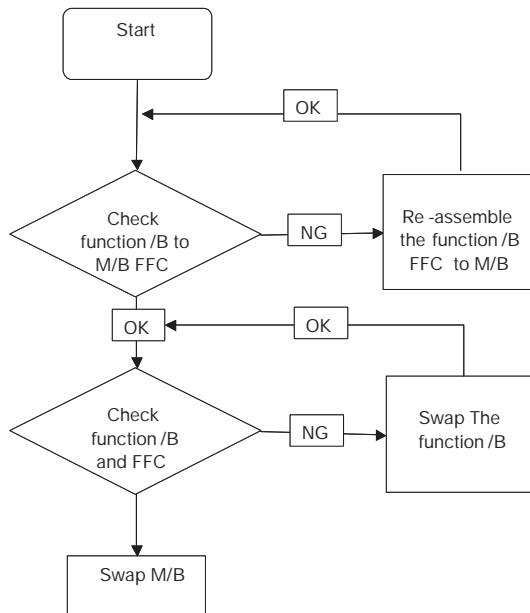

---

# Thermal Unit Failure

If the **Thermal Unit** fails, perform the following actions one at a time to correct the problem. Do not replace a non-defective FRUs:

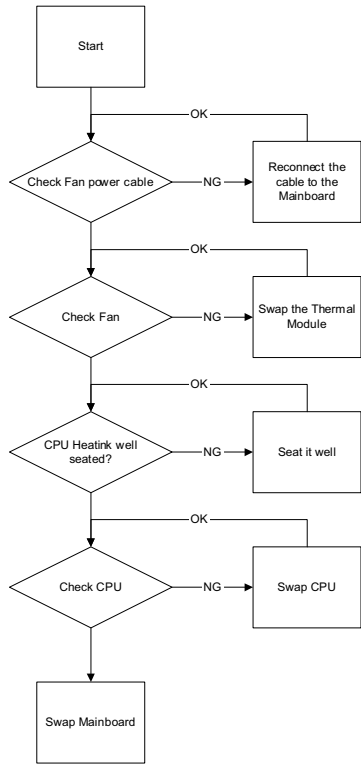

---

## External Mouse Failure

If an external **Mouse** fails, perform the following actions one at a time to correct the problem.

1. Try an alternative mouse.
2. If the mouse uses a wireless connection, insert new batteries and confirm there is a good connection. See the mouse user manual.
3. If the mouse uses a USB connection, try an alternate USB port.
4. Try an alternative program to verify mouse operation. Reinstall the program experiencing mouse failure.
5. Restart the computer.
6. Remove any recently added hardware and associated software.
7. Remove any recently added software and reboot.
8. Restore system and file settings from a known good date using **System Restore**.  
If the issue is not fixed, repeat the preceding steps and select an earlier time and date.
9. Run the Event Viewer to check the events log for errors. For more information see Windows Help and Support.
10. Roll back the mouse driver to the previous version if updated recently.
11. Remove and reinstall the mouse driver.
12. Check the Device Manager to determine that:
  - The device is properly installed. There are no red Xs or yellow exclamation marks.
  - There are no device conflicts.
  - No hardware is listed under Other Devices.
13. If the Issue is still not resolved, see “Online Support Information” on page 191.

## Other Failures

If the CRT Switch, Dock, LAN Port, external MIC or Speakers, PCI Express Card, 5-in-1 Card Reader or Volume Wheel fail, perform the following general steps to correct the problem. Do not replace a non-defective FRUs:

1. Check Drive whether is OK.
2. Check Test Fixture is ok.
3. Swap M/B to Try.

## Intermittent Problems

Intermittent system hang problems can be caused by a variety of reasons that have nothing to do with a hardware defect, such as: cosmic radiation, electrostatic discharge, or software errors. FRU replacement should be considered only when a recurring problem exists.

When analyzing an intermittent problem, do the following:

1. Run the advanced diagnostic test for the system board in loop mode at least 10 times.
2. If no error is detected, do not replace any FRU.
3. If any error is detected, replace the FRU. Rerun the test to verify that there are no more errors.

---

# Undetermined Problems

The diagnostic problems does not identify which adapter or device failed, which installed devices are incorrect, whether a short circuit is suspected, or whether the system is inoperative.

Follow these procedures to isolate the failing FRU (do not isolate non-defective FRU).

**NOTE:** Verify that all attached devices are supported by the computer.

**NOTE:** Verify that the power supply being used at the time of the failure is operating correctly. (See "Power On Issue" on page 149):

1. Power-off the computer.
2. Visually check them for damage. If any problems are found, replace the FRU.
3. Remove or disconnect all of the following devices:
  - Non-Acer devices
  - Printer, mouse, and other external devices
  - Battery pack
  - Hard disk drive
  - DIMM
  - CD-ROM/Diskette drive Module
  - PC Cards
4. Power-on the computer.
5. Determine if the problem has changed.
6. If the problem does not recur, reconnect the removed devices one at a time until you find the failing FRU.
7. If the problem remains, replace the following FRU one at a time. Do not replace a non-defective FRU:
  - System board
  - LCD assembly

---

# POST Code Tables

These tables describe the POST codes and descriptions during the POST.

## Sec

NO\_EVICTION\_MODE\_DEBUG EQU 1 (CommonPlatform\sec\ia32\SecCore.inc)

Post Code	Description
0xC2	MTRR setup
0xC3	Enable cache
0xC4	Establish cache tags
0xC5	Enter NEM, Place the BSP in No Fill mode, set CR0.CD = 1, CR0.NW = 0.
0xCF	Cache Init Finished

## Memory

DEBUG\_BIOS equ 1 (Chipset\Alviso\MemoryInitAsm\IA32\IMEMORY.INC)

Post Code	Description
0xA0	First memory check point
0x01	Enable MCHBAR
0x02	Check for DRAM initialization interrupt and reset fail
0x03	Verify all DIMMs are DDR or DDR2 and unbuffered
0x04	Detect an improper warm reset and handle
0x05	Detect if ECC SO-DIMMs are present in the system
0x06	Verify all DIMMs are single or double sided and not asymmetric
0x07	Verify all DIMMs are x8 or x16 width
0x08	Find a common CAS latency between the DIMMS and the MCH
0x09	Determine the memory frequency and CAS latency to program
0x10	Determine the smallest common TRAS for all DIMMs
0x11	Determine the smallest common TRP for all DIMMs
0x12	Determine the smallest common TRCD for all DIMMs
0x13	Determine the smallest refresh period for all DIMMs
0x14	Verify burst length of 8 is supported by all DIMMs
0x15	Determine the smallest tWR supported by all DIMMs
0x16	Determine DIMM size parameters
0x17	Program the correct system memory frequency
0x18	Determine and set the mode of operation for the memory channels
0x19	Program clock crossing registers
0x20	Disable Fast Dispatch
0x21	Program the DRAM Row Attributes and DRAM Row Boundary registers
0x22	Program the DRAM Bank Architecture register
0x23	Program the DRAM Timing & and DRAM Control registers
0x24	Program ODT
0x25	Perform steps required before memory init
0x26	Program the receive enable reference timing control register

---

## DLL Timing Control Registers, RCOMP settings

Post Code	Description
0x27	Enable DRAM Channel I/O Buffers
0x28	Enable all clocks on populated rows
0x29	Perform JEDEC memory initialization for all memory rows
0x30	Perform steps required after memory init
0x31	Program DRAM throttling and throttling event registers
0x32	Setup DRAM control register for normal operation and enable
0x33	Enable RCOMP
0x34	Clear DRAM initialization bit in the SB
0x35	Initialization Sequence Completed, program graphic clocks
0x43	Program Thermal Throttling

## BDS & Specific action:

Post Code	Description
0x00	Report the legacy boot is happening
0x12	Wake up the Aps
0x13	Initialize SMM Private Data and relocate BSP SMBASE
0x21	PC init begin at the stage1
0x27	Report every memory range do the hard ware ECC init
0x28	Report status code of every memory range
0x50	Get the root bridge handle
0x51	Notify pci bus driver starts to program the resource
0x58	Reset the host controller
0x5A	IdeBus begin initialization
0x79	Report that the remote terminal is being disabled
0x7A	Report that the remote terminal is being enabled
0x90	Keyboard reset
0x91	USB Keyboard disable
0x92	Keyboard detection
0x93	Report that the usb keyboard is being enabled
0x94	Clear the keyboard buffer
0x95	Init Keyboard
0x98	Mouse reset
0x99	Mouse disable
0x9A	Detect PS2 mouse
0x9B	Report that the mouse is being enabled
0xB8	Peripheral removable media reset(ex:IsaFloppy, USB device)
0xB9	Peripheral removable media disable
0xBB	Peripheral removable media enable
0xE4	Report Status Code here for DXE_ENTRY_POINT once it is available
0xF8	Report that ExitBootServices() has been called
0xF9	Runtime driver set virtual address map

## Each PEIM entry point used in 80\_PORT

Post Code	Description
0x00	
0x01	PEI_EVENT_LOG
0xA1	PEI_OEM_SERVICE
0xA2	PEI_SIO_INIT
0xA3	PEI_MONO_STATUS_CODE
0xA4	PEI_CPU_IO_PCI_CFG
0x06	PEI_CPU_IO
0x07	PEI_PCI_CFG
0xA5	PEI_CPU_PEIM
0xA6	PEI_PLATFORM_STAGE1
0xA7	PEI_VARIABLE



Post Code	Description
0xA8	PEI_SB_INIT
0x0C	PEI_CAPSULE
0xAA	PEI_PLATFORM_STAGE2
0xAC	PEI_SB_SMBUS_ARP_DISABLED
0x0F	PEI_HOST_TO_SYSTEM
0x40	PEI_MEMORY_INIT
0x41	PEI_S3_RESUME
0xAD	PEI_CLOCK_GEN
0xAB	PEI_OP_PRESENCE
0xAE	PEI_FIND_FV
0x16	PEI_H2O_DEBUG_IO
0x17	PEI_H2O_DEBUG_COMM
0x16~0x1F	PEI_RESERVED
0x20~0x2E	PEI_OEM_DEFINED
0xAF	PEI_DXE_IPL

Each Driver entry point used in 80\_PORT

Post Code	Description
0x30	RESERVED
0xB6	DXE_CRC32_SECTION_EXTRACT
0xB8	SCRIPT_SAVE
0xB9	ACPI_S3_SAVE
0xBA	SMART_TIMER
0xBB	JPEG_DECODER
0xBC	PCX_DECODER
0xBE	HT_CPU / MP_CPU
0xBF	LEGACY_METRONOME
0xC0	FTWLITE
0xC1	RUN_RIME
0xC2	MONOTONIC_COUNTER
0xC3	WATCH_DOG_TIMER
0xC4	SECURITY_STUB
0xC5	DXE_CPU_IO
0xC6	CF9_RESET
0xC7	PC_RTC
0xC8	STATUS_CODE
0xC9	VARIABLE
	EMU_VARIABLE
0xD9	DXE_CHIPSET_INIT
0x45	DXE_ALERT_FORMAT
0xD6	PCI_HOST_BRIDGE
0xD7	PCI_EXPRESS
0xD5	DXE_SB_INIT
0xDA	IDE_CONTROLLER

Post Code	Description
0xDB	SATA_CONTROLLER
0xDD	SB_SM_BUS
0xE7	ISA_ACPI_DRIVER
0xE8	ISA_BUS
0xE9	ISA_SERIAL
0xED	BUS_PCI_UNDI
0xEC	PCI_BUS
0xF6	BOOT_PRIORITY
0xF7	FVB_SERVICE
0xF8	ACPI_PLATFORM
0xFB	PCI_HOT_PLUG
0xFC	DXE_PLATFORM
0xFD	PLATFORM_IDE
0x97	SMBIOS
0x98	MEMORY_SUB_CLASS
0x99	MISC_SUB_CLASS
0x82	CON_PLATFORM
0x83	SAVE_MEMORY_CONFIG
0x84	ACPI_SUPPORT
0x85	CON_SPLITTER_UGA_VGA / CON_SPLITTER
0x88	VGA_CLASS
0x89	DATA_HUB
0x60	DISK_IO
0x8B	MEMORY_TEST
0x62	CRISIS_RECOVERY
0x8D	LEGACY_8259
0x8E	LEGACY_REGION
0x8F	LEGACY_INTERRUPT
0x70	BIOS_KEYBOARD
0x71	BIOS_VEDIO
0x72	MONITER_KEY
0x73	LEGACY_BIOS
0x75	LEGACY_BIOS_PLATFORM
0x76	PCI_PLATFORM
0x6C	ISA_FLOOPY
0x6D	PS2_MOUSE
0x6E	USB_BOT
0x6F	USB_CBIO
0x74	USB_MOUSE
0xFA	SETUP_UTILITY
0x90	FW_BLOCK_SERVICE
0x78	SMM_USB_LEGACY
0x86	GRAPHICS_CONSOLE

Post Code	Description
0x87	TERMINAL
0x8A	DATA_HUB_STD_ERR
0x7C	FAT
0x7D	PARTITION
0x7E	ENGLISH
0x7F	FRENCH
0x9E	HII_DATABASE
0x9F	OEM_SETUP_BROWSER
0x8C	OEM_BADGING_SUPPORT
0xF9	SETUP_MOUSE
0x72	MONITOR_KEY
0xBD	PLATFORM_BDS
0x8D	RESERVED
0x8E	RESERVED
0x8F	RESERVED
0xA0	DXE_H2O_DEBUG_IO
0xB3	DXE_TPM_TCG
0xB4	DXE_TPM_PHYSICAL_PRESENCE
0xB7	DXE_OEM_SERVICE
0x9B	DXE_SECURITY_HDD_PASSWORD_SERVICE
0xA9	DXE_LAN_IDER_CONTROLLER
0x9C	DXE_SECURITY_SYSTEM_PASSWORD_SERVICE
0x9D	DXE_SECURITY_PASSWORD_CONSOLE
0xCB	DXE_DATA_HUB_RECORD_POLICY
0xB5	DXE_TPM_DRIVER
0x11	CHINESE
0xB0	JAPANESE
0xB1	DXE_UNICODE_COLLATION

Each SmmDriver entry point used in 80\_PORT

Post Code	Description
0xD4	SMM_ACCESS
0xDE	SMM_CONTROL
0xCC	SMM_BASE
0xD2	SMM_RUNTIME
0xDF	SB_SMM_DISPATCH
0xD0	SMM_THUNK
0xCA	SMM_ACPI_SW_CHILD
0xFE	SMM_PLATFORM
0xD8	SMM_GMCH_MBI
0x90	SMM_FW_BLOCK_SERVICE
0x91	SMM_VARIABLE

---

<b>Post Code</b>	<b>Description</b>
0x92	SMM_IHISI
0x93	SMM_INT15_MICROCODE
0x94	SMM_PNP
0x95	SMM_INIT_PPM
0xD3	SMM_OEM_SERVICE

# Jumper and Connector Locations

## Top View

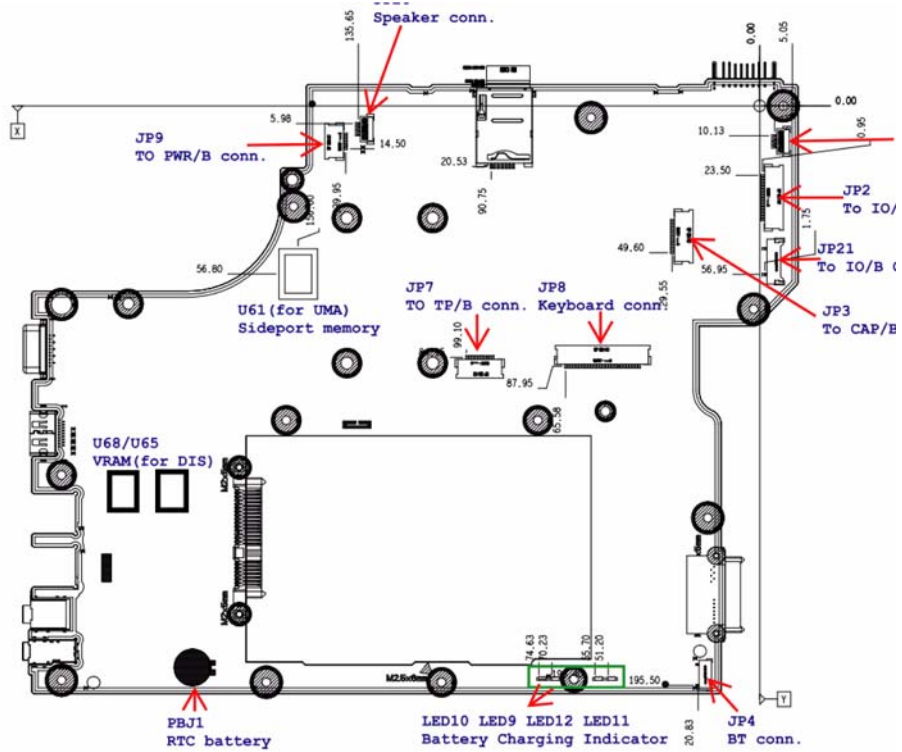

ITEM	DESCRIPTION	ITEM	DESCRIPTION
JP2	Connect to IO/B (FFC)	U61	Side-port memory (for UMA)
JP3	Connect to CAP/B (FFC)	U65 / U68	VRAM (for DIS)
JP4	Connect to Bluetooth (Cable)	LED9	Battery Charging Indicator
JP7	Connect to Touch pad (FFC)	LED10	LED10 / LED12 AMB
JP8	Connect to Keyboard	LED11	LED9 / LED11?Blue
JP9	Connect to Power BTN board (FFC)	LED12	
JP19	Connect to Digital MIC	JP21	Connect to IO/B (Cable)
JP20	Connect to speaker	PBJ1	RTC battery

# Bottom View

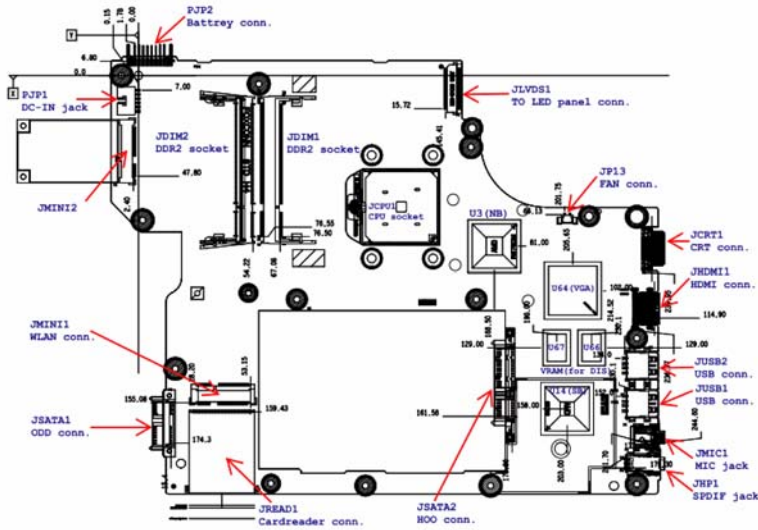

ITEM	DESCRIPTION	ITEM	DESCRIPTION
PJP1	Connect to Battery	JREAD1	Card reader
PJP2	DC-IN jack	JCRT1	CRT Connector
JDIM1 / JDIM2	DDR2 Memory socket	JHDMI1	HDMI Connector
JLVDS1	Connect to LED Panel	JP13	FAN Connector
JSATA1	Connect to SATA ODD		
JSATA2	Connect to SATA HDD	JCPU1	CPU socket
JMINI1	Connect to WLAN	U3	NB
JMINI2	Reserved	U14	SB
JUSB1 / JUSB2	USB Connector	U64	M92-S2LP VGA
JMIC1	Connect to external microphone	U66 / U67	VRAM (for DIS)
JHP1	Connect to external SPDIF		

---

# Clearing Password Check and BIOS Recovery

This section provide you the standard operating procedures of clearing password and BIOS recovery for Aspire 5538. Aspire 5538 provides one Hardware Open Gap on main board for clearing password check, and one Hotkey for enabling BIOS Recovery.

## Clearing Password Check

### Hardware Open Gap Description

Item	Description	Location
R397	Clear CMOS Jumper	Memory Bay

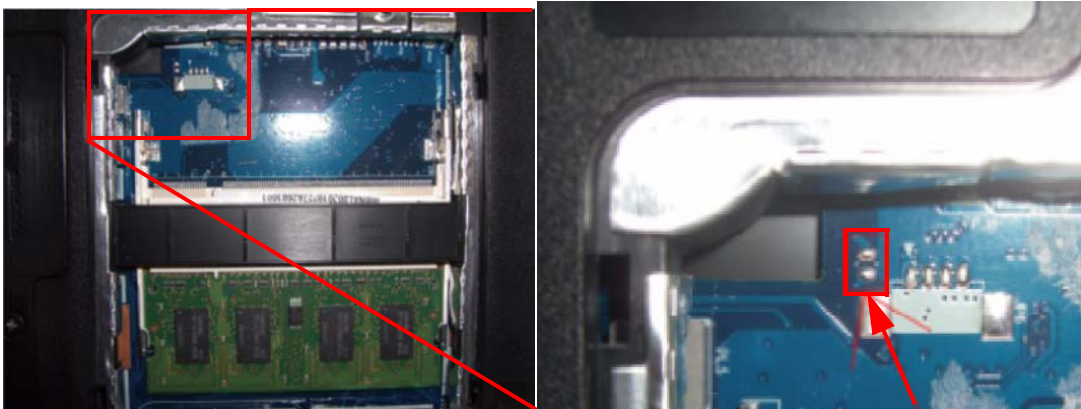

### Steps for Clearing BIOS Password Check

If users set BIOS Password (Supervisor Password and/or User Password) for a security reason, BIOS will ask the password during systems POST or when systems enter to BIOS Setup menu. However, once it is necessary to bypass the password check, users need to short the HW Gap to clear the password by the following steps:

1. Flash to BIOS v1.04 (or later version), and enter BIOS Setup Utility.
2. Set the Supervisor password, User Password, and power on password. Press **F10**, and save and exit. After the Save, the notebook auto re-starts.
3. After power-on, the system prompts to input the password. Enter the password set in step 1 and allow the device to startup.
4. Press and hold the power key to shutdown the system.
5. Open the memory door and remove the memory modules.
6. Remove the battery pack and AC adapter.
7. Short the R72 Pins shown above (ensure that the circuit is complete).
8. Replace the memory modules and close memory door.
9. Replace the battery pack and power on the system.
10. Press **F2** at the prompt to enter BIOS. Check the **Security** screen shows Supervisor and User Passwords are clear.



---

# BIOS Recovery by Crisis Disk

## BIOS Recovery Boot Block:

BIOS Recovery Boot Block is a special block of BIOS. It is used to boot up the system with minimum BIOS initialization. Users can enable this feature to restore the BIOS firmware to a successful one once the previous BIOS flashing process failed.

## BIOS Recovery Hotkey:

The system provides a function hotkey: **Fn+Esc**, for enable BIOS Recovery process when system is powered on during BIOS POST. To use this function, it is strongly recommended to have the AC adapter and Battery present. If this function is enabled, the system will force the BIOS to enter a special BIOS block, called Boot Block.

## Steps for BIOS Recovery from USB Storage:

Before doing this, prepare the Crisis USB key. The Crisis USB key could be made by executing the Crisis Disk program in another system with Windows XP OS.

Follow the steps below:

1. Save ROM file (file name: **JAL90x64.fd**) to the root directory of USB storage.
2. Plug USB storage into USB port.
3. Press **Fn + ESC** button then plug in AC.  
The Power button flashes once.
4. Press **Power** button to initiate system CRISIS mode.  
When CRISIS is complete, the system auto restarts with a workable BIOS.
5. Update the latest version BIOS for this machine by regular BIOS flashing process.

# FRU (Field Replaceable Unit) List

---

This chapter gives you the FRU (Field Replaceable Unit) listing in global configurations of Acer. Refer to this chapter whenever ordering for parts to repair or for RMA (Return Merchandise Authorization).

Please note that WHEN ORDERING FRU PARTS, you should check the most up-to-date information available on your regional web or channel. For whatever reasons a part number change is made, it will not be noted on the printed Service Guide. For ACER AUTHORIZED SERVICE PROVIDERS, your Acer office may have a DIFFERENT part number code from those given in the FRU list of this printed Service Guide. You MUST use the local FRU list provided by your regional Acer office to order FRU parts for repair and service of customer machines.

**NOTE:** To scrap or to return the defective parts, you should follow the local government ordinance or regulations on how to dispose it properly, or follow the rules set by your regional Acer office on how to return it.

# Aspire 5538 Exploded Diagrams

## Main Assembly

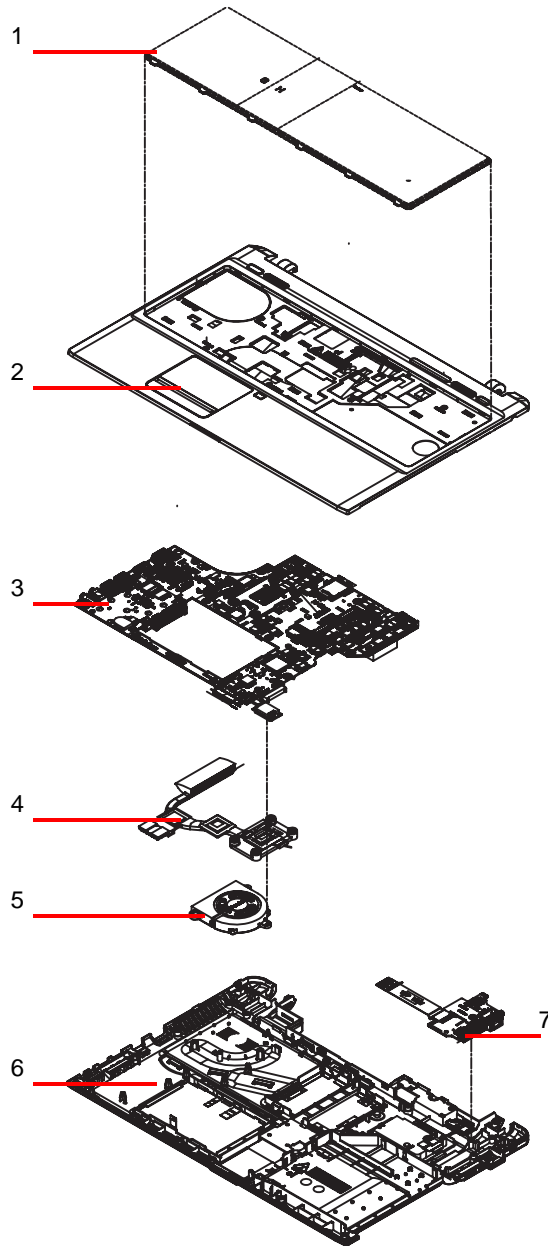

No.	Description	Acer P/N	No.	Description	Acer P/N
1	Keyboard	KB.I170A.0**	5	Fan	23.PEA02.001
2	Upper Cover	60.PEA02.001	6	Lower Cover	60.PEA02.002
3	Mainboard	MB.PE902.001/ MB.PEA02.001	7	I/O Board	55.PEA02.004
4	Thermal Unit	60.PEA02.005 60.PE902.001			

\*\*Multiple Configurations Available



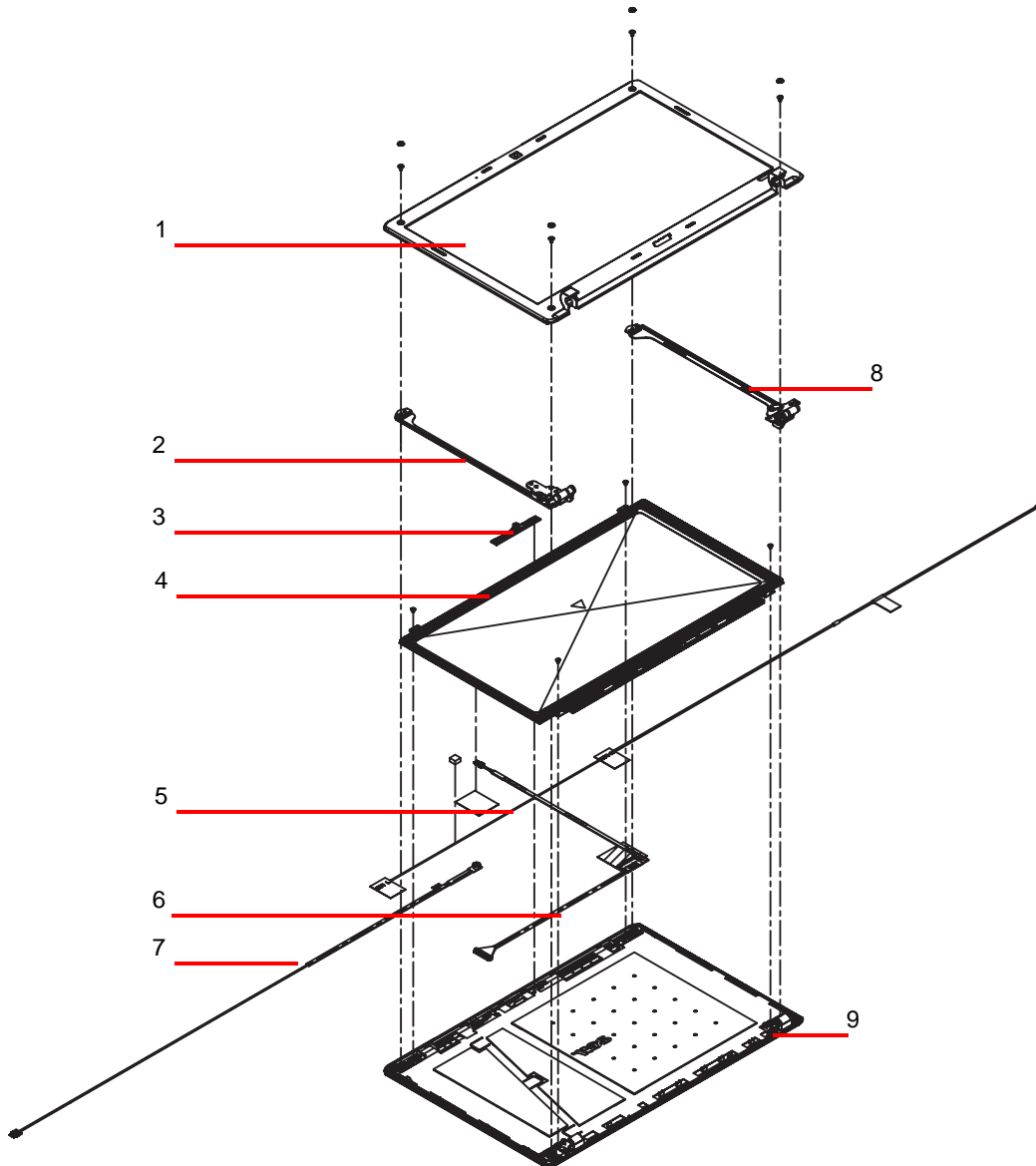



# LCD Assembly



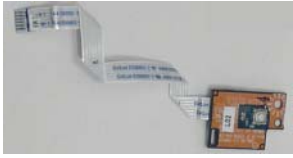
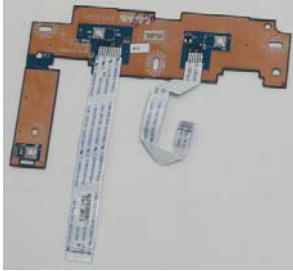





No.	Description	Acer P/N	No.	Description	Acer P/N
1	LCD Bezel	60.PEA02.004	6	LVDS Cable	50.PEA02.004
2	Left LCD Bracket	33.PEA02.005	7	Microphone and cable	23.PEA02.002
3	Camera	57.PEA02.001	8	Right LCD bracket	33.PEA02.005
4	LCD Panel	LK.15608.003	9	LCD Cover	60.PEA02.003
5	WLAN Antenna	50.PEA02.005/ 50.PEA02.006			

# Aspire 5538 FRU List

CATEGORY	Acer PN	Acer Description
<b>ADAPTER</b>		
	AP.06501.027	Adapter DELTA 65W 19V 1.7x5.5x11 Yellow (ADP-65MH B A) LV5, LF LF
	AP.06503.026	Adapter LITE-ON 65W 19V 1.7x5.5x11 Yellow (PA-1650-22AG), LV5 LF
	AP.0650A.013	Adapter HIPRO 65W 19V 1.7x5.5x11 Yellow (HP-A0653R3B 1LF), LV5 LF
<b>BATTERY</b>		
	BT.00603.082	Battery SANYO AS-2009D Li-Ion 3S2P SANYO 6 cell 4400mAh Main COMMON ID: AS09D31 W/ Halogen Free
	BT.00603.090	Battery SANYO AS-2009D Li-Ion 3S2P SANYO 6 cell 4400mAh Main COMMON AS09D31
	BT.00604.039	Battery SONY AS-2009D Li-Ion 3S2P SONY 6 cell 4400mAh Main COMMON ID : AS09D41 W/ Halogen Free
	BT.00604.043	Battery SONY AS-2009D Li-Ion 3S2P SANYO 6 cell 4400mAh Main COMMON AS09D41
	BT.00605.041	Battery PANASONIC AS-2009D Li-Ion 3S2P PANASONIC 6 cell 4400mAh Main COMMON ID: AS09D51 W/ Halogen Free
	BT.00605.048	Battery PANASONIC AS-2009D Li-Ion 3S2P PANASONIC 6 cell 4400mAh Main COMMON AS09D41
	BT.00607.078	Battery SIMPLO AS-2009D Li-Ion 3S2P PANASONIC 6 cell 4400mAh Main COMMON 2.2CG, ID: AS09D71 W/ Halogen Free
	BT.00607.079	Battery SIMPLO AS-2009D Li-Ion 3S2P LGC 6 cell 4400mAh Main COMMON 2.2S3, ID: AS09D73 W/ Halogen Free
	BT.00607.080	Battery SIMPLO AS-2009D Li-Ion 3S2P SAMSUNG 6 cell 4400mAh Main COMMON 2.2F, ID: AS09D75 W/ Halogen Free
	BT.00607.096	Battery SIMPLO AS-2009D Li-Ion 3S2P PANASONIC 6 cell 4400mAh Main COMMON AS09D71
	BT.00607.097	Battery SIMPLO AS-2009D Li-Ion 3S2P LGC 6 cell 4400mAh Main COMMON AS09D73
	BT.00607.098	Battery SIMPLO AS-2009D Li-Ion 3S2P SAMSUNG 6 cell 4400mAh Main COMMON AS09D75
<b>BOARD</b>		
	55.PEA02.001	MEDIA BOARD

CATEGORY	Acer PN	Acer Description
	55.PEA02.002	POWER BOARD
	55.PEA02.003	TP BOARD
	55.PEA02.004	IO BOARD
	BH.21100.004	Foxconn Bluetooth BRM 2046 BT2.1 (T60H928.33) f/w:861
	BT.21100.005	FOXCONN BLUETOOTH FOX_BRM_2.0 F/W 300
	NI.23600.007	Foxconn FOX_ATH_XB63 Foxconn Atheros XB63 minicard b/g
	NI.23600.030	Foxconn Wireless LAN Atheros AR5B91 1x2 BGN
	NI.23600.031	Foxconn Wireless LAN Wireless LAN Ralink RT2700E 1x2 BGN
	NI.23600.033	QMI Wireless LAN Atheros AR5B91 1x2 BGN (EM303)
	NI.23600.046	Foxconn Wireless LAN Atheros HB93 1x2 BGN (HM)
	NI.23600.047	Foxconn Wireless LAN Atheros HB95 1x1 BG (HM)
<b>CABLE</b>		
	50.PEA02.001	BLUE TOOTH CABLE
	50.PEA02.002	IO BOARD CABLE
	50.PEA02.003	DC-IN CABLE

CATEGORY	Acer PN	Acer Description
	50.PEA02.004	LCD CABLE
	50.PEA02.005	ANTENNA WLAN
	50.PEA02.006	ANTENNA WLAN-AUX L
Power Cord	27.TAVV5.001	POWER CORD US 3 PIN
	27.TAVV5.002	POWER CORD EU 3 PIN
	27.TAVV5.003	POWER CORD AUS 3 PIN
	27.TAVV5.004	POWER CORD UK 3 PIN
	27.TAVV5.005	POWER CORD CHINA 3 PIN
	27.TAVV5.006	POWER CORD SWISS 3 PIN
	27.TAVV5.007	POWER CORD ITALIAN 3 PIN
	27.TAVV5.008	POWER CORD DENMARK 3 PIN
	27.TAVV5.009	POWER CORD JP 3 PIN
	27.TAVV5.010	POWER CORD SOUTH AFRICA 3 PIN
	27.TAVV5.011	POWER CORD KOREA 3 PIN
	27.TAVV5.012	POWER CORD ISRAEL 3 PIN
	27.TAVV5.013	POWER CORD INDIA 3 PIN
	27.TAVV5.014	POWER CORD TWN 3 PIN
	27.APV02.001	POWER CORD ARGENTINA 3 PIN
CASE/COVER/BRACKET ASSEMBLY		
	33.PEA02.001	TP BRACKET
	33.PEA02.002	HDD BRACKET
	33.PEA02.003	CAP SENSOR BRACKET
	33.PEA02.004	ODD BRACKET
	33.PEA02.005	LCD HINGE R&L





CATEGORY	Acer PN	Acer Description
	42.PEA02.001	RAM DOOR
	42.PEA02.002	HDD DOOR
	42.PEA02.003	ODD BEZEL-SM
	60.PEA02.001	UPPER CASE ASSY
	60.PEA02.002	LOWER CASE
	60.PEA02.003	LCD COVER
	60.PEA02.004	LCD BEZEL
<b>CPU/PROCESSOR</b>		
	KC.AL002.110	CPU AMD Athlon L110 PGA 1.2G 512K single core
	KC.AL002.310	CPU AMD Athlon L310 PGA 1.2G 1M Dual Core
	KC.ATF02.200	CPU AMD Athlon TF20 PGA 1.6G 512K 638 15W G2
<b>DIGITAL LIGHT DEVICE</b>		
	57.PEA02.001	CAMERA 1.0M
<b>DVD RW DRIVE</b>		

CATEGORY	Acer PN	Acer Description
	6M.PEA02.001	ODD SUPER-MULTI DRIVE MODULE
	KU.00807.068	ODD PANASONIC Super-Multi DRIVE 9.5mm Tray DL 8X UJ892 LF W/O bezel SATA GBAS2.0, HF
	KU.0080D.043	ODD HLDS Super-Multi DRIVE 9.5mm Tray DL 8X GU10N LF W/O bezel SATA GBAS2.0, HF
<b>HDD/HARD DISK DRIVE</b>		
	KH.16001.034	HDD SEAGATE 2.5" 5400rpm 160GB ST9160310AS Crockett SATA LF F/W:0303
	KH.16004.006	HDD TOSHIBA 2.5" 5400rpm 160GB MK1655GSX Libra SATA LF F/W: FG011J
	KH.16007.024	HDD HGST 2.5" 5400rpm 160GB HTS545016B9A300 Panther B SATA LF F/W:C60F
	KH.16008.022	HDD WD 2.5" 5400rpm 160GB WD1600BEVT-22ZCT0 ML160 SATA LF F/W:11.01A11
	KH.25001.016	HDD SEAGATE 2.5" 5400rpm 250GB ST9250315AS Wyatt SATA LF F/W:0001SDM1
	KH.25004.003	HDD TOSHIBA 2.5" 5400rpm 250GB MK2555GSX Libra SATA LF F/W:FG001J
	KH.25007.015	HDD HGST 2.5" 5400rpm 250GB HTS545025B9A300 Panther B SATA LF F/W:C60F
	KH.25008.021	HDD WD 2.5" 5400rpm 250GB WD2500BEVT-22ZCT0 ML160 SATA LF F/W:11.01A11
	KH.32001.008	HDD SEAGATE 2.5" 5400rpm 320GB ST9320320AS Crockett SATA LF F/W:0303
	KH.32004.002	HDD TOSHIBA 2.5" 5400rpm 320GB MK3255GSX Libra SATA LF F/W:FG011J
	KH.32007.007	HDD HGST 2.5" 5400rpm 320GB HTS545032B9A300 Panther B SATA LF F/W: C60F
	KH.32008.013	HDD WD 2.5" 5400rpm 320GB WD3200BEVT-22ZCT0 ML160 SATA LF F/W:11.01A11
	KH.50001.011	HDD SEAGATE 2.5" 5400rpm 500GB ST9500325AS Wyatt SATA LF F/W:0001SDM1
	KH.50004.001	HDD TOSHIBA 2.5" 5400rpm 500GB MK5055GSX Libra SATA LF F/W:FG001J
	KH.50007.009	HDD HGST 2.5" 5400rpm 500GB HTS545050B9A300 Panther B SATA LF F/W:C60F
KH.50008.013	HDD WD 2.5" 5400rpm 500GB WD5000BEVT-22ZAT0 ML250 SATA LF F/W:01.01A01	
<b>HEATSINK</b>		
	23.PEA02.001	FAN

CATEGORY	Acer PN	Acer Description
	60.PE902.001	THERMAL MOUDLE-UMA
	60.PEA02.005	THERMAL MOUDLE-DIS
KEYBOARD		
	KB.I170A.032	Keyboard ACER AC7T JV50 Internal 17 Standard 103KS Black Arabic Texture
	KB.I170A.033	Keyboard ACER AC7T JV50 Internal 17 Standard 104KS Black Belgium Texture
	KB.I170A.034	Keyboard ACER AC7T JV50 Internal 17 Standard 104KS Black Brazilian Portuguese Texture
	KB.I170A.035	Keyboard ACER AC7T JV50 Internal 17 Standard 104KS Black CZ/SK Texture
	KB.I170A.036	Keyboard ACER AC7T JV50 Internal 17 Standard 103KS Black Chinese Texture
	KB.I170A.037	Keyboard ACER AC7T JV50 Internal 17 Standard 104KS Black Danish Texture
	KB.I170A.038	Keyboard ACER AC7T JV50 Internal 17 Standard 104KS Black FR/Arabic Texture
	KB.I170A.039	Keyboard ACER AC7T JV50 Internal 17 Standard 104KS Black French Texture
	KB.I170A.040	Keyboard ACER AC7T JV50 Internal 17 Standard 104KS Black German Texture
	KB.I170A.041	Keyboard ACER AC7T JV50 Internal 17 Standard 103KS Black Greek Texture
	KB.I170A.042	Keyboard ACER AC7T JV50 Internal 17 Standard 104KS Black Hungarian Texture
	KB.I170A.043	Keyboard ACER AC7T JV50 Internal 17 Standard 104KS Black Italian Texture
	KB.I170A.044	Keyboard ACER AC7T JV50 Internal 17 Standard 107KS Black Japanese Texture
	KB.I170A.045	Keyboard ACER AC7T JV50 Internal 17 Standard 104KS Black Nordic Texture
	KB.I170A.046	Keyboard ACER AC7T JV50 Internal 17 Standard 104KS Black Norwegian Texture
	KB.I170A.047	Keyboard ACER AC7T JV50 Internal 17 Standard 104KS Black Portuguese Texture
	KB.I170A.048	Keyboard ACER AC7T JV50 Internal 17 Standard 103KS Black Russian Texture
	KB.I170A.049	Keyboard ACER AC7T JV50 Internal 17 Standard 104KS Black SLO/CRO Texture
	KB.I170A.050	Keyboard ACER AC7T JV50 Internal 17 Standard 104KS Black Spanish Texture
	KB.I170A.051	Keyboard ACER AC7T JV50 Internal 17 Standard 104KS Black Sweden Texture
KB.I170A.052	Keyboard ACER AC7T JV50 Internal 17 Standard 104KS Black Swiss/G Texture	

CATEGORY	Acer PN	Acer Description
	KB.I170A.053	Keyboard ACER AC7T JV50 Internal 17 Standard 103KS Black Thailand Texture
	KB.I170A.054	Keyboard ACER AC7T JV50 Internal 17 Standard 104KS Black Turkish Texture
	KB.I170A.055	Keyboard ACER AC7T JV50 Internal 17 Standard 104KS Black UK Texture
	KB.I170A.056	Keyboard ACER AC7T JV50 Internal 17 Standard 103KS Black US International Texture
	KB.I170A.057	Keyboard ACER AC7T JV50 Internal 17 Standard 103KS Black US International w/ Hebrew Texture
	KB.I170A.058	Keyboard ACER AC7T JV50 Internal 17 Standard 104KS Black US w/ Canadian French Texture
LCD		
	6M.PEA02.002	ASSY LEC LCD MODULE 15.6" WXGA GLARE W/ ANTENNA, CAMERA
LCD PANEL		
	LK.15606.004	LED LCD SAMSUNG 15.6"W WXGA Glare LTN156AT06-A01 LF 200nit 16ms
	LK.15608.003	LED LCD LPL 15.6"W WXGA Glare LP156WH3-TLA1 LF 200nit 8ms 500:1
MAINBOARD		
	MB.PE902.001	Mainboard AS5538 ATI RS780 SB710 Acer Logo LF UMA
	MB.PEA02.001	Mainboard AS5538G ATI RS780 SB710 512M-GD3 Acer Logo W/O 1394 V1.0 LF M92LP
MEMORY		
	KN.1GB03.026	Memory NANYA SO-DIMM DDRII 667 1GB NT1GT64UH8D0FN-3C LF 64*16 0.07um
	KN.1GB0B.027	Memory SAMSUNG SO-DIMM DDRII 667 1GB M470T2864EH3-CE6 LF 64*16 0.055um
	KN.1GB0G.012	Memory HYNIX SO-DIMM DDRII 667 1GB HYMP112S64CP6-Y5 LF
	KN.2GB03.011	Memory NANYA SO-DIMM DDRII 667 2GB NT2GT64U8HD0BN-3C LF 128*8 0.07um
	KN.2GB0B.011	Memory SAMSUNG SO-DIMM DDRII 667 2GB M470T5663EH3-CE6 LF 128*8 0.055um
	KN.2GB0G.004	Memory HYNIX SO-DIMM DDRII 667 2GB HYMP125S64CP8-Y5 LF
MISCELLANEOUS		
	40.PEA02.001	NAME PLATE-AS5538

CATEGORY	Acer PN	Acer Description
	47.PEA02.001	LCD SCREW RUBBER
	47.PEA02.002	LOG_UP MYLAR_B
	47.PEA02.003	LCD CABLE MYLAR
SPEAKER		
	23.PEA02.002	MIC SET
	23.PEA02.003	SPEAKER R&L

## Screw List

Acer P/N	Description
86.PEA02.001	SCREW M2.46D 3.0LK 5.5D 0.8T ZKNL
86.PEA02.002	SCREW M2D 3L K 3.05D NI NL
86.PEA02.003	SCREW M2.48D 4.0LK 5.5D 0.8T ZKNL
86.PEA02.004	SCREW M2.5D 4.15LK 5.5D ZK NLCR3
86.PEA02.005	EAX20_HDD_ERING_SCREW_CLIP
86.PEA02.006	SCREW M2.45D 8.0LK 5.5D 0.8T ZKNL
86.PEA02.007	SCREW M2.48D 6.0LK 5.5D 0.8T ZKNL
86.PEA02.008	SCREW M3.0D 3L K 5.0D ZK NLCR3
86.PEA02.009	SCREW M2.5D 3.2L K 6D NI

27.TAVV5.001	POWER CORD US 3 PIN
27.TAVV5.002	POWER CORD EU 3 PIN
27.TAVV5.003	POWER CORD AUS 3 PIN
27.TAVV5.004	POWER CORD UK 3 PIN
27.TAVV5.005	POWER CORD CHINA 3 PIN
27.TAVV5.006	POWER CORD SWISS 3 PIN
27.TAVV5.007	POWER CORD ITALIAN 3 PIN
27.TAVV5.008	POWER CORD DENMARK 3 PIN
27.TAVV5.009	POWER CORD JP 3 PIN
27.TAVV5.010	POWER CORD SOUTH AFRICA 3 PIN
27.TAVV5.011	POWER CORD KOREA 3 PIN

---

27.TAVV5.012	POWER CORD ISRAEL 3 PIN
27.TAVV5.013	POWER CORD INDIA 3 PIN
27.TAVV5.014	POWER CORD TWN 3 PIN
27.APV02.001	POWER CORD ARGENTINA 3 PIN





# Model Definition and Configuration

## Aspire 5538 Series

Model	RO	Country	Acer Part No	Description
AS5538-113G25Mn	EMEA	Eastern Europe	LX.PE90C.001	AS5538-113G25Mn LINPUSAEU7 UMACss 2G+1G/250/BT/6L/5R/CB_bgn_0.3D_AN_ENQ1
AS5538-314G32Mn	EMEA	Middle East	LX.PE90C.002	AS5538-314G32Mn LINPUSAME4 UMACss 2*2G/320/BT/6L2.2/5R/CB_bgn_0.3D_AN_EN72
AS5538-203G25Mn	AAP	Australia/ New Zealand	LX.PE90C.003	AS5538-203G25Mn LINPUSAAU1 UMACss 2G+1G/250/6L2.2/5R/CB_bgn_0.3D_AN_EN11
AS5538-113G25Mn	EMEA	UK	LX.PE90X.001	AS5538-113G25Mn VHP32ATGB1 MC UMACss 2G+1G/250/6L/5R/CB_bgn_0.3D_AN_EN14
AS5538-113G25Mn	EMEA	Ukraine	LX.PE90X.002	AS5538-113G25Mn VHP32ATUK1 MC UMACss 2G+1G/250/6L/5R/CB_bgn_0.3D_AN_RU11
AS5538-113G25Mn	EMEA	Turkey	LX.PE90X.003	AS5538-113G25Mn EM VHP32ATTR1 MC UMACss 2G+1G/250/6L/5R/CB_bgn_0.3D_AN_TR33
AS5538-113G25Mn	EMEA	Switzerland	LX.PE90X.004	AS5538-113G25Mn VHP32ATCH1 MC UMACss 2G+1G/250/6L/5R/CB_bgn_0.3D_AN_IT42
AS5538-113G25Mn	EMEA	Poland	LX.PE90X.005	AS5538-113G25Mn VHP32ATPL1 MC UMACss 2G+1G/250/6L/5R/CB_bgn_0.3D_AN_PL11
AS5538-113G25Mn	EMEA	Middle East	LX.PE90X.006	AS5538-113G25Mn EM VHP32ATME2 MC UMACss 2G+1G/250/6L/5R/CB_bgn_0.3D_AN_AR23
AS5538-113G25Mn	EMEA	Middle East	LX.PE90X.007	AS5538-113G25Mn EM VHP32ATME3 MC UMACss 2G+1G/250/6L/5R/CB_bgn_0.3D_AN_FR23
AS5538-113G25Mn	EMEA	Middle East	LX.PE90X.008	AS5538-113G25Mn EM VHP32ATME2 MC UMACss 2G+1G/250/6L/5R/CB_bgn_0.3D_AN_AR13
AS5538-113G25Mn	EMEA	Middle East	LX.PE90X.009	AS5538-113G25Mn EM VHP32ATME4 MC UMACss 2G+1G/250/6L/5R/CB_bgn_0.3D_AN_RU61
AS5538-113G25Mn	EMEA	Middle East	LX.PE90X.010	AS5538-113G25Mn EM VHP32ATME4 MC UMACss 2G+1G/250/6L/5R/CB_bgn_0.3D_AN_EN11
AS5538-113G25Mn	EMEA	Middle East	LX.PE90X.011	AS5538-113G25Mn EM VHP32ATME2 MC UMACss 2G+1G/250/6L/5R/CB_bgn_0.3D_AN_EN15
AS5538-113G25Mn	EMEA	Middle East	LX.PE90X.012	AS5538-113G25Mn EM VHP32ATME6 MC UMACss 2G+1G/250/6L/5R/CB_bgn_0.3D_AN_EN15
AS5538-113G25Mn	EMEA	Middle East	LX.PE90X.013	AS5538-113G25Mn EM VHP32ATME9 MC UMACss 2G+1G/250/6L/5R/CB_bgn_0.3D_AN_FR22
AS5538-113G25Mn	EMEA	Italy	LX.PE90X.014	AS5538-113G25Mn VHP32ATIT1 MC UMACss 2G+1G/250/6L/5R/CB_bgn_0.3D_AN_IT12
AS5538-113G25Mn	EMEA	Israel	LX.PE90X.015	AS5538-113G25Mn VHP32ATIL1 MC UMACss 2G+1G/250/6L/5R/CB_bgn_0.3D_AN_HE12

Model	RO	Country	Acer Part No	Description
AS5538-113G25Mn	EMEA	Greece	LX.PE90X.016	AS5538-113G25Mn VHP32ATGR1 MC UMACss 2G+1G/250/6L/5R/CB_bgn_0.3D_AN_EL32
AS5538-113G25Mn	EMEA	Spain	LX.PE90X.017	AS5538-113G25Mn VHP32ATES1 MC UMACss 2G+1G/250/6L/5R/CB_bgn_0.3D_AN_ES22
AS5538-113G25Mn	EMEA	Portugal	LX.PE90X.018	AS5538-113G25Mn VHP32ATPT1 MC UMACss 2G+1G/250/6L/5R/CB_bgn_0.3D_AN_PT12
AS5538-113G25Mn	EMEA	Hungary	LX.PE90X.019	AS5538-113G25Mn VHP32ATHU1 MC UMACss 2G+1G/250/6L/5R/CB_bgn_0.3D_AN_HU13
AS5538-113G25Mn	EMEA	Finland	LX.PE90X.020	AS5538-113G25Mn VHP32ATFI2 MC UMACss 2G+1G/250/6L/5R/CB_bgn_0.3D_AN_FI11
AS5538-113G25Mn	EMEA	Eastern Europe	LX.PE90X.021	AS5538-113G25Mn VHP32ATEU5 MC UMACss 2G+1G/250/6L/5R/CB_bgn_0.3D_AN_RO12
AS5538-113G25Mn	EMEA	Eastern Europe	LX.PE90X.022	AS5538-113G25Mn VHP32ATEU3 MC UMACss 2G+1G/250/6L/5R/CB_bgn_0.3D_AN_RU23
AS5538-113G25Mn	EMEA	Eastern Europe	LX.PE90X.023	AS5538-113G25Mn VHP32ATEU5 MC UMACss 2G+1G/250/6L/5R/CB_bgn_0.3D_AN_PL13
AS5538-113G25Mn	EMEA	Eastern Europe	LX.PE90X.024	AS5538-113G25Mn VHP32ATEU4 MC UMACss 2G+1G/250/6L/5R/CB_bgn_0.3D_AN_SV22
AS5538-113G25Mn	EMEA	Eastern Europe	LX.PE90X.025	AS5538-113G25Mn VHP32ATEU7 MC UMACss 2G+1G/250/6L/5R/CB_bgn_0.3D_AN_ENR2
AS5538-113G25Mn	EMEA	Eastern Europe	LX.PE90X.026	AS5538-113G25Mn VHP32ATEU7 MC UMACss 2G+1G/250/6L/5R/CB_bgn_0.3D_AN_SL11
AS5538-113G25Mn	EMEA	Czech	LX.PE90X.027	AS5538-113G25Mn VHP32ATCZ2 MC UMACss 2G+1G/250/6L/5R/CB_bgn_0.3D_AN_SK12
AS5538-113G25Mn	EMEA	Sweden	LX.PE90X.028	AS5538-113G25Mn VHP32ATSE1 MC UMACss 2G+1G/250/6L/5R/CB_bgn_0.3D_AN_FI13
AS5538-113G25Mn	EMEA	Austria	LX.PE90X.029	AS5538-113G25Mn VHP32ATAT1 MC UMACss 2G+1G/250/6L/5R/CB_bgn_0.3D_AN_DE11
AS5538-113G25Mi	EMEA	Russia	LX.PE90X.030	AS5538-113G25Mi VHP32ATRU1 MC UMACss 2G+1G/250/6L/5R/CB_bg_0.3D_AN_RU11
AS5538-113G25Mn	EMEA	Norway	LX.PE90X.031	AS5538-113G25Mn VHP32ATNO3 MC UMACss 2G+1G/250/6L/5R/CB_bgn_0.3D_AN_ENS3
AS5538-113G25Mn	EMEA	Norway	LX.PE90X.032	AS5538-113G25Mn VHP32ATNO3 MC UMACss 2G+1G/250/6L/5R/CB_bgn_0.3D_AN_ENS4
AS5538-113G25Mn	EMEA	Norway	LX.PE90X.033	AS5538-113G25Mn VHP32ATNO1 MC UMACss 2G+1G/250/6L/5R/CB_bgn_0.3D_AN_NO12
AS5538-113G25Mn	EMEA	Luxembo urg	LX.PE90X.034	AS5538-113G25Mn VHP32ATLU3 MC UMACss 2G+1G/250/6L/5R/CB_bgn_0.3D_AN_IT41
AS5538-113G25Mn	EMEA	Holland	LX.PE90X.035	AS5538-113G25Mn VHP32ATNL1 MC UMACss 2G+1G/250/6L/5R/CB_bgn_0.3D_AN_NL12
AS5538-113G25Mn	EMEA	Belgium	LX.PE90X.036	AS5538-113G25Mn VHP32ATBE1 MC UMACss 2G+1G/250/6L/5R/CB_bgn_0.3D_AN_NL13
AS5538-113G25Mn	EMEA	Germany	LX.PE90X.037	AS5538-113G25Mn VHP32ATDE1 MC UMACss 2G+1G/250/6L/5R/CB_bgn_0.3D_AN_DE13
AS5538-113G25Mn	EMEA	France	LX.PE90X.038	AS5538-113G25Mn VHP32ATFR1 MC UMACss 2G+1G/250/6L/5R/CB_bgn_0.3D_AN_FR23
AS5538-113G25Mn	EMEA	Denmark	LX.PE90X.039	AS5538-113G25Mn VHP32ATDK2 MC UMACss 2G+1G/250/6L/5R/CB_bgn_0.3D_AN_ENS3
AS5538-113G25Mn	EMEA	Denmark	LX.PE90X.040	AS5538-113G25Mn VHP32ATDK1 MC UMACss 2G+1G/250/6L/5R/CB_bgn_0.3D_AN_NO13
AS5538-113G25Mn	EMEA	South Africa	LX.PE90X.041	AS5538-113G25Mn EM VHP32ATZA4 MC UMACss 2G+1G/250/6L/5R/CB_bgn_0.3D_AN_ENI1

Model	RO	Country	Acer Part No	Description
AS5538-113G25Mn	EMEA	South Africa	LX.PE90X.042	AS5538-113G25Mn EM VHP32ATZA1 MC UMACss 2G+1G/250/6L/5R/ CB_bgn_0.3D_AN_FR23
AS5538-113G25Mn	EMEA	South Africa	LX.PE90X.043	AS5538-113G25Mn EM VHP32ATZA2 MC UMACss 2G+1G/250/6L/5R/ CB_bgn_0.3D_AN_EN16
AS5538-113G32Mn	EMEA	Norway	LX.PE90X.044	AS5538-113G32Mn VHP32ATNO1 MC UMACss 2G+1G/320/6L/5R/CB_bgn_0.3D_AN_NO12
AS5538-114G25Mn	EMEA	Spain	LX.PE90X.045	AS5538-114G25Mn VHP32ATES1 MC UMACss 2*2G/250/6L2.2/5R/CB_bgn_0.3D_AN_ES22
AS5538-114G50Mn	EMEA	Spain	LX.PE90X.046	AS5538-114G50Mn VHP32ATES1 MC UMACss 2*2G/500_L/6L2.2/5R/CB_bgn_0.3D_AN_ES22
AS5538-312G25Mn	EMEA	Middle East	LX.PE90X.047	AS5538-312G25Mn EM VHP32ATME2 MC UMACss 1*2G/250/BT/6L2.2/5R/ CB_bgn_0.3D_AN_AR23
AS5538-312G25Mn	CHINA	Hong Kong	LX.PE90Y.001	AS5538-312G25Mn VHB32ATHK2 MC UMACss 1*2G/250/6L/5R/CB_bgn_0.3D_AN_ZH31
AS5538-312G25Mn	CHINA	China	LX.PE90Y.002	AS5538-312G25Mn VHB32ATCN1 MC UMACss 1*2G/250/6L/5R/CB_bgn_0.3D_AN_SC11
AS5538G-313G32Mn	EMEA	Eastern Europe	LX.PEA0C.001	AS5538G-313G32Mn LINPUSAEU7 M92LP512Ccss_V3 2G+1G/320/BT/6L/5R/ CB_bgn_0.3D_AN_ENQ1
AS5538G-314G32Mn	EMEA	Middle East	LX.PEA0C.002	AS5538G-314G32Mn LINPUSAME4 M92LP512Ccss_V3 2*2G/320/BT/6L2.2/5R/ CB_bgn_0.3D_AN_EN72
AS5538G-313G32Mn	EMEA	UK	LX.PEA0X.001	AS5538G-313G32Mn VHP32ATGB1 MC M92LP512Ccss_V3 2G+1G/320/6L/5R/ CB_bgn_0.3D_AN_EN14
AS5538G-313G32Mn	EMEA	Ukraine	LX.PEA0X.002	AS5538G-313G32Mn VHP32ATUK1 MC M92LP512Ccss_V3 2G+1G/320/6L/5R/ CB_bgn_0.3D_AN_RU11
AS5538G-313G32Mn	EMEA	Turkey	LX.PEA0X.003	AS5538G-313G32Mn EM VHP32ATTR1 MC M92LP512Ccss_V3 2G+1G/320/6L/5R/ CB_bgn_0.3D_AN_TR33
AS5538G-313G32Mn	EMEA	Middle East	LX.PEA0X.004	AS5538G-313G32Mn EM VHP32ATME2 MC M92LP512Ccss_V3 2G+1G/320/6L/5R/ CB_bgn_0.3D_AN_AR23
AS5538G-313G32Mn	EMEA	Poland	LX.PEA0X.005	AS5538G-313G32Mn VHP32ATPL1 MC M92LP512Ccss_V3 2G+1G/320/6L/5R/ CB_bgn_0.3D_AN_PL11
AS5538G-313G32Mn	EMEA	Switzerland	LX.PEA0X.006	AS5538G-313G32Mn VHP32ATCH1 MC M92LP512Ccss_V3 2G+1G/320/6L/5R/ CB_bgn_0.3D_AN_IT42
AS5538G-313G32Mn	EMEA	Middle East	LX.PEA0X.007	AS5538G-313G32Mn EM VHP32ATME4 MC M92LP512Ccss_V3 2G+1G/320/6L/5R/ CB_bgn_0.3D_AN_EN11
AS5538G-313G32Mn	EMEA	Middle East	LX.PEA0X.008	AS5538G-313G32Mn EM VHP32ATME4 MC M92LP512Ccss_V3 2G+1G/320/6L/5R/ CB_bgn_0.3D_AN_RU61
AS5538G-313G32Mn	EMEA	Middle East	LX.PEA0X.009	AS5538G-313G32Mn EM VHP32ATME2 MC M92LP512Ccss_V3 2G+1G/320/6L/5R/ CB_bgn_0.3D_AN_AR13
AS5538G-313G32Mn	EMEA	Middle East	LX.PEA0X.010	AS5538G-313G32Mn EM VHP32ATME3 MC M92LP512Ccss_V3 2G+1G/320/6L/5R/ CB_bgn_0.3D_AN_FR23

Model	RO	Country	Acer Part No	Description
AS5538G-313G32Mn	EMEA	Middle East	LX.PEA0X.011	AS5538G-313G32Mn EM VHP32ATME2 MC M92LP512Css_V3 2G+1G/320/6L/5R/ CB_bgn_0.3D_AN_EN15
AS5538G-313G32Mn	EMEA	Middle East	LX.PEA0X.012	AS5538G-313G32Mn EM VHP32ATME6 MC M92LP512Css_V3 2G+1G/320/6L/5R/ CB_bgn_0.3D_AN_EN15
AS5538G-313G32Mn	EMEA	Middle East	LX.PEA0X.013	AS5538G-313G32Mn EM VHP32ATME9 MC M92LP512Css_V3 2G+1G/320/6L/5R/ CB_bgn_0.3D_AN_FR22
AS5538G-313G32Mn	EMEA	Greece	LX.PEA0X.014	AS5538G-313G32Mn VHP32ATGR1 MC M92LP512Css_V3 2G+1G/320/6L/5R/ CB_bgn_0.3D_AN_EL32
AS5538G-313G32Mn	EMEA	Israel	LX.PEA0X.015	AS5538G-313G32Mn VHP32ATIL1 MC M92LP512Css_V3 2G+1G/320/6L/5R/ CB_bgn_0.3D_AN_HE12
AS5538G-313G32Mn	EMEA	Italy	LX.PEA0X.016	AS5538G-313G32Mn VHP32ATIT1 MC M92LP512Css_V3 2G+1G/320/6L/5R/ CB_bgn_0.3D_AN_IT12
AS5538G-313G32Mn	EMEA	Finland	LX.PEA0X.017	AS5538G-313G32Mn VHP32ATFI2 MC M92LP512Css_V3 2G+1G/320/6L/5R/ CB_bgn_0.3D_AN_FI11
AS5538G-313G32Mn	EMEA	Hungary	LX.PEA0X.018	AS5538G-313G32Mn VHP32ATHU1 MC M92LP512Css_V3 2G+1G/320/6L/5R/ CB_bgn_0.3D_AN_HU13
AS5538G-313G32Mn	EMEA	Portugal	LX.PEA0X.019	AS5538G-313G32Mn VHP32ATPT1 MC M92LP512Css_V3 2G+1G/320/6L/5R/ CB_bgn_0.3D_AN_PT12
AS5538G-313G32Mn	EMEA	Spain	LX.PEA0X.020	AS5538G-313G32Mn VHP32ATES1 MC M92LP512Css_V3 2G+1G/320/6L/5R/ CB_bgn_0.3D_AN_ES22
AS5538G-313G32Mn	EMEA	Eastern Europe	LX.PEA0X.021	AS5538G-313G32Mn VHP32ATEU5 MC M92LP512Css_V3 2G+1G/320/6L/5R/ CB_bgn_0.3D_AN_RO12
AS5538G-313G32Mn	EMEA	Eastern Europe	LX.PEA0X.022	AS5538G-313G32Mn VHP32ATEU3 MC M92LP512Css_V3 2G+1G/320/6L/5R/ CB_bgn_0.3D_AN_RU23
AS5538G-313G32Mn	EMEA	Eastern Europe	LX.PEA0X.023	AS5538G-313G32Mn VHP32ATEU5 MC M92LP512Css_V3 2G+1G/320/6L/5R/ CB_bgn_0.3D_AN_PL13
AS5538G-313G32Mn	EMEA	Eastern Europe	LX.PEA0X.024	AS5538G-313G32Mn VHP32ATEU7 MC M92LP512Css_V3 2G+1G/320/6L/5R/ CB_bgn_0.3D_AN_SL11
AS5538G-313G32Mn	EMEA	Eastern Europe	LX.PEA0X.025	AS5538G-313G32Mn VHP32ATEU7 MC M92LP512Css_V3 2G+1G/320/6L/5R/ CB_bgn_0.3D_AN_ENR2
AS5538G-313G32Mn	EMEA	Eastern Europe	LX.PEA0X.026	AS5538G-313G32Mn VHP32ATEU4 MC M92LP512Css_V3 2G+1G/320/6L/5R/ CB_bgn_0.3D_AN_SV22
AS5538G-313G32Mi	EMEA	Russia	LX.PEA0X.027	AS5538G-313G32Mi VHP32ATRU1 MC M92LP512Css_V3 2G+1G/320/6L/5R/ CB_bg_0.3D_AN_RU11
AS5538G-313G32Mn	EMEA	Austria	LX.PEA0X.028	AS5538G-313G32Mn VHP32ATAT1 MC M92LP512Css_V3 2G+1G/320/6L/5R/ CB_bgn_0.3D_AN_DE11
AS5538G-313G32Mn	EMEA	Sweden	LX.PEA0X.029	AS5538G-313G32Mn VHP32ATSE1 MC M92LP512Css_V3 2G+1G/320/6L/5R/ CB_bgn_0.3D_AN_FI13

Model	RO	Country	Acer Part No	Description
AS5538G-313G32Mn	EMEA	Czech	LX.PEA0X.030	AS5538G-313G32Mn VHP32ATCZ2 MC M92LP512Css_V3 2G+1G/320/6L/5R/ CB_bgn_0.3D_AN_SK12
AS5538G-313G32Mn	EMEA	Norway	LX.PEA0X.031	AS5538G-313G32Mn VHP32ATNO3 MC M92LP512Css_V3 2G+1G/320/6L/5R/ CB_bgn_0.3D_AN_ENS3
AS5538G-313G32Mn	EMEA	Norway	LX.PEA0X.032	AS5538G-313G32Mn VHP32ATNO3 MC M92LP512Css_V3 2G+1G/320/6L/5R/ CB_bgn_0.3D_AN_ENS4
AS5538G-313G32Mn	EMEA	Norway	LX.PEA0X.033	AS5538G-313G32Mn VHP32ATNO1 MC M92LP512Css_V3 2G+1G/320/6L2.2/5R/ CB_bgn_0.3D_AN_NO12
AS5538G-313G32Mn	EMEA	Belgium	LX.PEA0X.034	AS5538G-313G32Mn VHP32ATBE1 MC M92LP512Css_V3 2G+1G/320/6L/5R/ CB_bgn_0.3D_AN_NL13
AS5538G-313G32Mn	EMEA	Holland	LX.PEA0X.035	AS5538G-313G32Mn VHP32ATNL1 MC M92LP512Css_V3 2G+1G/320/6L/5R/ CB_bgn_0.3D_AN_NL12
AS5538G-313G32Mn	EMEA	Luxembo urg	LX.PEA0X.036	AS5538G-313G32Mn VHP32ATLU3 MC M92LP512Css_V3 2G+1G/320/6L/5R/ CB_bgn_0.3D_AN_IT41
AS5538G-313G32Mn	EMEA	Denmark	LX.PEA0X.037	AS5538G-313G32Mn VHP32ATDK1 MC M92LP512Css_V3 2G+1G/320/6L/5R/ CB_bgn_0.3D_AN_NO13
AS5538G-313G32Mn	EMEA	Denmark	LX.PEA0X.038	AS5538G-313G32Mn VHP32ATDK2 MC M92LP512Css_V3 2G+1G/320/6L/5R/ CB_bgn_0.3D_AN_ENS3
AS5538G-313G32Mn	EMEA	France	LX.PEA0X.039	AS5538G-313G32Mn VHP32ATFR1 MC M92LP512Css_V3 2G+1G/320/6L/5R/ CB_bgn_0.3D_AN_FR23
AS5538G-313G32Mn	EMEA	Germany	LX.PEA0X.040	AS5538G-313G32Mn VHP32ATDE1 MC M92LP512Css_V3 2G+1G/320/6L/5R/ CB_bgn_0.3D_AN_DE13
AS5538G-313G32Mn	EMEA	South Africa	LX.PEA0X.041	AS5538G-313G32Mn EM VHP32ATZA4 MC M92LP512Css_V3 2G+1G/320/6L/5R/ CB_bgn_0.3D_AN_ENI1
AS5538G-313G32Mn	EMEA	South Africa	LX.PEA0X.042	AS5538G-313G32Mn EM VHP32ATZA1 MC M92LP512Css_V3 2G+1G/320/6L/5R/ CB_bgn_0.3D_AN_FR23
AS5538G-313G32Mn	EMEA	South Africa	LX.PEA0X.043	AS5538G-313G32Mn EM VHP32ATZA2 MC M92LP512Css_V3 2G+1G/320/6L/5R/ CB_bgn_0.3D_AN_EN16
AS5538G-313G32Mn	EMEA	Norway	LX.PEA0X.044	AS5538G-313G32Mn VHP32ATNO1 MC M92LP512Css_V3 2G+1G/320/6L/5R/ CB_bgn_0.3D_AN_NO12
AS5538G-312G32Mn	CHINA	Hong Kong	LX.PEA0X.045	AS5538G-312G32Mn VHP32ATHK2 MC M92LP512Css_V3 1*2G/320/BT/6L/5R/ CB_bgn_0.3D_AN_ZH31
AS5538G-312G32Mn	CHINA	China	LX.PEA0X.046	AS5538G-312G32Mn VHP32ATCN1 MC M92LP512Css_V3 1*2G/320/BT/6L/5R/ CB_bgn_0.3D_AN_SC11
AS5538G-313G32Mn	EMEA	Middle East	LX.PEA0X.047	AS5538G-313G32Mn EM VHP32ATME2 MC M92LP512Css_V3 2G+1G/320/BT/6L/5R/ CB_bgn_0.3D_AN_AR23
AS5538G-314G32Mn	EMEA	Spain	LX.PEA0X.048	AS5538G-314G32Mn VHP32ATES1 MC M92LP512Css_V3 2*2G/320/6L2.2/5R/ CB_bgn_0.3D_AN_ES22

Model	RO	Country	Acer Part No	Description
AS5538-111G25Mn	CHINA	Hong Kong	LX.PEB0Y.001	AS5538-111G25Mn VHB32ATHK2 MC UMass 1*1G/250/6L/5R/CB_bgn_AN_ZH31
AS5538-111G25Mn	CHINA	China	LX.PEB0Y.002	AS5538-111G25Mn VHB32ATCN1 MC UMass 1*1G/250/6L/5R/CB_bgn_AN_SC11
AS5538-312G25Mn	WW	GCTWN	S2.PE90C.001	AS5538-312G25Mn LINPUSAWW1 UMACss 2*1G/250/BT/6L/5R/CB_bgn_1.0D_AN_ENX1
AS5538-312G25Mn	WW	WW	S2.PE90C.002	AS5538-312G25Mn LINPUSAWW1 UMACss 2*1G/250/BT/6L/5R/CB_bgn_1.0D_AN_EN11
AS5538G-312G25Mn	WW	WW	S2.PEA0C.001	AS5538G-312G25Mn LINPUSAWW1 M92LP512Css_V3 2*1G/250/BT/6L2.2/5R/CB_bgn_0.3D_AN_EN11
AS5538-312G25Mn	WW	WW	S2.PEB0C.001	AS5538-312G25Mn LINPUSAWW1 UMass 2*1G/250/BT/6L2.2/5R/CB_bgn_AN_EN11

Model	CPU	LCD	VGA Chip	VRAM 1
AS5538-113G25Mn	AAL110	NLED15.6WXGAGS	UMA	N
AS5538-314G32Mn	AAL310	NLED15.6WXGAGS	UMA	N
AS5538-203G25Mn	AATF20	NLED15.6WXGAGS	UMA	N
AS5538-113G25Mn	AAL110	NLED15.6WXGAGS	UMA	N
AS5538-113G25Mn	AAL110	NLED15.6WXGAGS	UMA	N
AS5538-113G25Mn	AAL110	NLED15.6WXGAGS	UMA	N
AS5538-113G25Mn	AAL110	NLED15.6WXGAGS	UMA	N
AS5538-113G25Mn	AAL110	NLED15.6WXGAGS	UMA	N
AS5538-113G25Mn	AAL110	NLED15.6WXGAGS	UMA	N
AS5538-113G25Mn	AAL110	NLED15.6WXGAGS	UMA	N
AS5538-113G25Mn	AAL110	NLED15.6WXGAGS	UMA	N
AS5538-113G25Mn	AAL110	NLED15.6WXGAGS	UMA	N
AS5538-113G25Mn	AAL110	NLED15.6WXGAGS	UMA	N
AS5538-113G25Mn	AAL110	NLED15.6WXGAGS	UMA	N
AS5538-113G25Mn	AAL110	NLED15.6WXGAGS	UMA	N
AS5538-113G25Mn	AAL110	NLED15.6WXGAGS	UMA	N
AS5538-113G25Mn	AAL110	NLED15.6WXGAGS	UMA	N
AS5538-113G25Mn	AAL110	NLED15.6WXGAGS	UMA	N
AS5538-113G25Mn	AAL110	NLED15.6WXGAGS	UMA	N
AS5538-113G25Mn	AAL110	NLED15.6WXGAGS	UMA	N
AS5538-113G25Mn	AAL110	NLED15.6WXGAGS	UMA	N
AS5538-113G25Mn	AAL110	NLED15.6WXGAGS	UMA	N
AS5538-113G25Mn	AAL110	NLED15.6WXGAGS	UMA	N
AS5538-113G25Mn	AAL110	NLED15.6WXGAGS	UMA	N
AS5538-113G25Mn	AAL110	NLED15.6WXGAGS	UMA	N
AS5538-113G25Mn	AAL110	NLED15.6WXGAGS	UMA	N
AS5538-113G25Mn	AAL110	NLED15.6WXGAGS	UMA	N
AS5538-113G25Mn	AAL110	NLED15.6WXGAGS	UMA	N
AS5538-113G25Mn	AAL110	NLED15.6WXGAGS	UMA	N
AS5538-113G25Mn	AAL110	NLED15.6WXGAGS	UMA	N
AS5538-113G25Mn	AAL110	NLED15.6WXGAGS	UMA	N
AS5538-113G25Mn	AAL110	NLED15.6WXGAGS	UMA	N
AS5538-113G25Mn	AAL110	NLED15.6WXGAGS	UMA	N
AS5538-113G25Mi	AAL110	NLED15.6WXGAGS	UMA	N
AS5538-113G25Mn	AAL110	NLED15.6WXGAGS	UMA	N







Model	CPU	LCD	VGA Chip	VRAM 1
AS5538G-313G32Mi	AAL310	NLED15.6WXGAGS	M92LP	512M-DDR3 (64*16*4)
AS5538G-313G32Mn	AAL310	NLED15.6WXGAGS	M92LP	512M-DDR3 (64*16*4)
AS5538G-313G32Mn	AAL310	NLED15.6WXGAGS	M92LP	512M-DDR3 (64*16*4)
AS5538G-313G32Mn	AAL310	NLED15.6WXGAGS	M92LP	512M-DDR3 (64*16*4)
AS5538G-313G32Mn	AAL310	NLED15.6WXGAGS	M92LP	512M-DDR3 (64*16*4)
AS5538G-313G32Mn	AAL310	NLED15.6WXGAGS	M92LP	512M-DDR3 (64*16*4)
AS5538G-313G32Mn	AAL310	NLED15.6WXGAGS	M92LP	512M-DDR3 (64*16*4)
AS5538G-313G32Mn	AAL310	NLED15.6WXGAGS	M92LP	512M-DDR3 (64*16*4)
AS5538G-313G32Mn	AAL310	NLED15.6WXGAGS	M92LP	512M-DDR3 (64*16*4)
AS5538G-313G32Mn	AAL310	NLED15.6WXGAGS	M92LP	512M-DDR3 (64*16*4)
AS5538G-313G32Mn	AAL310	NLED15.6WXGAGS	M92LP	512M-DDR3 (64*16*4)
AS5538G-313G32Mn	AAL310	NLED15.6WXGAGS	M92LP	512M-DDR3 (64*16*4)
AS5538G-313G32Mn	AAL310	NLED15.6WXGAGS	M92LP	512M-DDR3 (64*16*4)
AS5538G-313G32Mn	AAL310	NLED15.6WXGAGS	M92LP	512M-DDR3 (64*16*4)
AS5538G-313G32Mn	AAL310	NLED15.6WXGAGS	M92LP	512M-DDR3 (64*16*4)
AS5538G-312G32Mn	AAL310	NLED15.6WXGAGS	M92LP	512M-DDR3 (64*16*4)
AS5538G-312G32Mn	AAL310	NLED15.6WXGAGS	M92LP	512M-DDR3 (64*16*4)
AS5538G-312G32Mn	AAL310	NLED15.6WXGAGS	M92LP	512M-DDR3 (64*16*4)
AS5538G-314G32Mn	AAL310	NLED15.6WXGAGS	M92LP	512M-DDR3 (64*16*4)
AS5538-111G25Mn	AAL110	NLED15.6WXGAGS	UMA	N
AS5538-111G25Mn	AAL110	NLED15.6WXGAGS	UMA	N
AS5538-312G25Mn	AAL310	NLED15.6WXGAGS	UMA	N
AS5538-312G25Mn	AAL310	NLED15.6WXGAGS	UMA	N
AS5538G-312G25Mn	AAL310	NLED15.6WXGAGS	M92LP	512M-DDR3 (64*16*4)
AS5538-312G25Mn	AAL310	NLED15.6WXGAGS	UMA	N

Model	Memory 1	Memory 2	HDD 1(GB)	ODD	Extra SW1	Card Reader
AS5538-113G25Mn	SO2GBII6	SO1GBII6	N250GB5.4KS	NSM8XS9.5	N	5 in 1-Built in
AS5538-314G32Mn	SO2GBII6	SO2GBII6	N320GB5.4KS	NSM8XS9.5	N	5 in 1-Built in
AS5538-203G25Mn	SO2GBII6	SO1GBII6	N250GB5.4KS	NSM8XS9.5	N	5 in 1-Built in
AS5538-113G25Mn	SO2GBII6	SO1GBII6	N250GB5.4KS	NSM8XS9.5	McAfee	5 in 1-Built in
AS5538-113G25Mn	SO2GBII6	SO1GBII6	N250GB5.4KS	NSM8XS9.5	McAfee	5 in 1-Built in
AS5538-113G25Mn	SO2GBII6	SO1GBII6	N250GB5.4KS	NSM8XS9.5	McAfee	5 in 1-Built in
AS5538-113G25Mn	SO2GBII6	SO1GBII6	N250GB5.4KS	NSM8XS9.5	McAfee	5 in 1-Built in
AS5538-113G25Mn	SO2GBII6	SO1GBII6	N250GB5.4KS	NSM8XS9.5	McAfee	5 in 1-Built in
AS5538-113G25Mn	SO2GBII6	SO1GBII6	N250GB5.4KS	NSM8XS9.5	McAfee	5 in 1-Built in
AS5538-113G25Mn	SO2GBII6	SO1GBII6	N250GB5.4KS	NSM8XS9.5	McAfee	5 in 1-Built in
AS5538-113G25Mn	SO2GBII6	SO1GBII6	N250GB5.4KS	NSM8XS9.5	McAfee	5 in 1-Built in
AS5538-113G25Mn	SO2GBII6	SO1GBII6	N250GB5.4KS	NSM8XS9.5	McAfee	5 in 1-Built in
AS5538-113G25Mn	SO2GBII6	SO1GBII6	N250GB5.4KS	NSM8XS9.5	McAfee	5 in 1-Built in
AS5538-113G25Mn	SO2GBII6	SO1GBII6	N250GB5.4KS	NSM8XS9.5	McAfee	5 in 1-Built in
AS5538-113G25Mn	SO2GBII6	SO1GBII6	N250GB5.4KS	NSM8XS9.5	McAfee	5 in 1-Built in
AS5538-113G25Mn	SO2GBII6	SO1GBII6	N250GB5.4KS	NSM8XS9.5	McAfee	5 in 1-Built in





Model	Memory 1	Memory 2	HDD 1(GB)	ODD	Extra SW1	Card Reader
AS5538G-312G25Mn	SO1GBII6	SO1GBII6	N250GB5.4KS	NSM8XS9.5	N	5 in 1-Built in
AS5538-312G25Mn	SO1GBII6	SO1GBII6	N250GB5.4KS	NSM8XS9.5	N	5 in 1-Built in

Model	Wireless LAN	Wireless LAN1	BT	OS	OS-Country Kit	K/B
AS5538-113G25Mn	3rd WiFi 1x2 BGN	3rd WiFi 1x2 BGN	BT 2.1	LINPUS	LINPUSAEU7ENQ1	SLO/CRO (KB.I170A.049)
AS5538-314G32Mn	3rd WiFi 1x2 BGN	3rd WiFi 1x2 BGN	BT 2.1	LINPUS	LINPUSAME4EN72	Russian (KB.I170A.048)
AS5538-203G25Mn	3rd WiFi 1x2 BGN	3rd WiFi 1x2 BGN	N	LINPUS	LINPUSAAU1EN11	US International (KB.I170A.056)
AS5538-113G25Mn	3rd WiFi 1x2 BGN	3rd WiFi 1x2 BGN	N	VHP32	VHP32ATGB1EN14	UK (KB.I170A.055)
AS5538-113G25Mn	3rd WiFi 1x2 BGN	3rd WiFi 1x2 BGN	N	VHP32	VHP32ATUK1RU11	Russian (KB.I170A.048)
AS5538-113G25Mn	3rd WiFi 1x2 BGN	3rd WiFi 1x2 BGN	N	VHP32	VHP32ATTR1TR33	Turkish (KB.I170A.054)
AS5538-113G25Mn	3rd WiFi 1x2 BGN	3rd WiFi 1x2 BGN	N	VHP32	VHP32ATCH1IT42	Swiss/G (KB.I170A.052)
AS5538-113G25Mn	3rd WiFi 1x2 BGN	3rd WiFi 1x2 BGN	N	VHP32	VHP32ATPL1PL11	US International (KB.I170A.056)
AS5538-113G25Mn	3rd WiFi 1x2 BGN	3rd WiFi 1x2 BGN	N	VHP32	VHP32ATME2AR23	Arabic (KB.I170A.032)
AS5538-113G25Mn	3rd WiFi 1x2 BGN	3rd WiFi 1x2 BGN	N	VHP32	VHP32ATME3FR23	French (KB.I170A.039)
AS5538-113G25Mn	3rd WiFi 1x2 BGN	3rd WiFi 1x2 BGN	N	VHP32	VHP32ATME2AR13	Arabic (KB.I170A.032)
AS5538-113G25Mn	3rd WiFi 1x2 BGN	3rd WiFi 1x2 BGN	N	VHP32	VHP32ATME4RU61	Russian (KB.I170A.048)
AS5538-113G25Mn	3rd WiFi 1x2 BGN	3rd WiFi 1x2 BGN	N	VHP32	VHP32ATME4EN11	Russian (KB.I170A.048)
AS5538-113G25Mn	3rd WiFi 1x2 BGN	3rd WiFi 1x2 BGN	N	VHP32	VHP32ATME2EN15	Arabic (KB.I170A.032)
AS5538-113G25Mn	3rd WiFi 1x2 BGN	3rd WiFi 1x2 BGN	N	VHP32	VHP32ATME6EN15	US International (KB.I170A.056)
AS5538-113G25Mn	3rd WiFi 1x2 BGN	3rd WiFi 1x2 BGN	N	VHP32	VHP32ATME9FR22	FR/Arabic (KB.I170A.038)
AS5538-113G25Mn	3rd WiFi 1x2 BGN	3rd WiFi 1x2 BGN	N	VHP32	VHP32ATIT1IT12	Italian (KB.I170A.043)
AS5538-113G25Mn	3rd WiFi 1x2 BGN	3rd WiFi 1x2 BGN	N	VHP32	VHP32ATIL1HE12	US International w/ Hebrew (KB.I170A.057)
AS5538-113G25Mn	3rd WiFi 1x2 BGN	3rd WiFi 1x2 BGN	N	VHP32	VHP32ATGR1EL32	Greek (KB.I170A.041)
AS5538-113G25Mn	3rd WiFi 1x2 BGN	3rd WiFi 1x2 BGN	N	VHP32	VHP32ATES1ES22	Spanish (KB.I170A.050)
AS5538-113G25Mn	3rd WiFi 1x2 BGN	3rd WiFi 1x2 BGN	N	VHP32	VHP32ATPT1PT12	Portuguese (KB.I170A.047)
AS5538-113G25Mn	3rd WiFi 1x2 BGN	3rd WiFi 1x2 BGN	N	VHP32	VHP32ATHU1HU13	Hungarian (KB.I170A.042)

Model	Wireless LAN	Wireless LAN1	BT	OS	OS-Country Kit	K/B
AS5538-113G25Mn	3rd WiFi 1x2 BGN	3rd WiFi 1x2 BGN	N	VHP32	VHP32ATFI2FI11	Sweden (KB.I170A.051)
AS5538-113G25Mn	3rd WiFi 1x2 BGN	3rd WiFi 1x2 BGN	N	VHP32	VHP32ATEU5RO12	US International (KB.I170A.056)
AS5538-113G25Mn	3rd WiFi 1x2 BGN	3rd WiFi 1x2 BGN	N	VHP32	VHP32ATEU3RU23	Russian (KB.I170A.048)
AS5538-113G25Mn	3rd WiFi 1x2 BGN	3rd WiFi 1x2 BGN	N	VHP32	VHP32ATEU5PL13	US International (KB.I170A.056)
AS5538-113G25Mn	3rd WiFi 1x2 BGN	3rd WiFi 1x2 BGN	N	VHP32	VHP32ATEU4SV22	Sweden (KB.I170A.051)
AS5538-113G25Mn	3rd WiFi 1x2 BGN	3rd WiFi 1x2 BGN	N	VHP32	VHP32ATEU7ENR2	SLO/CRO (KB.I170A.049)
AS5538-113G25Mn	3rd WiFi 1x2 BGN	3rd WiFi 1x2 BGN	N	VHP32	VHP32ATEU7SL11	SLO/CRO (KB.I170A.049)
AS5538-113G25Mn	3rd WiFi 1x2 BGN	3rd WiFi 1x2 BGN	N	VHP32	VHP32ATCZ2SK12	CZ/SK (KB.I170A.035)
AS5538-113G25Mn	3rd WiFi 1x2 BGN	3rd WiFi 1x2 BGN	N	VHP32	VHP32ATSE1FI13	Sweden (KB.I170A.051)
AS5538-113G25Mn	3rd WiFi 1x2 BGN	3rd WiFi 1x2 BGN	N	VHP32	VHP32ATAT1DE11	German (KB.I170A.040)
AS5538-113G25Mi	3rd WiFi 1x2 BGN	3rd WiFi BG	N	VHP32	VHP32ATRU1RU11	Russian (KB.I170A.048)
AS5538-113G25Mn	3rd WiFi 1x2 BGN	3rd WiFi 1x2 BGN	N	VHP32	VHP32ATNO3ENS3	Nordic (KB.I170A.045)
AS5538-113G25Mn	3rd WiFi 1x2 BGN	3rd WiFi 1x2 BGN	N	VHP32	VHP32ATNO3ENS4	Nordic (KB.I170A.045)
AS5538-113G25Mn	3rd WiFi 1x2 BGN	3rd WiFi 1x2 BGN	N	VHP32	VHP32ATNO1NO12	Norwegian (KB.I170A.046)
AS5538-113G25Mn	3rd WiFi 1x2 BGN	3rd WiFi 1x2 BGN	N	VHP32	VHP32ATLU3IT41	Swiss/G (KB.I170A.052)
AS5538-113G25Mn	3rd WiFi 1x2 BGN	3rd WiFi 1x2 BGN	N	VHP32	VHP32ATNL1NL12	US International (KB.I170A.056)
AS5538-113G25Mn	3rd WiFi 1x2 BGN	3rd WiFi 1x2 BGN	N	VHP32	VHP32ATBE1NL13	Belgium (KB.I170A.033)
AS5538-113G25Mn	3rd WiFi 1x2 BGN	3rd WiFi 1x2 BGN	N	VHP32	VHP32ATDE1DE13	German (KB.I170A.040)
AS5538-113G25Mn	3rd WiFi 1x2 BGN	3rd WiFi 1x2 BGN	N	VHP32	VHP32ATFR1FR23	French (KB.I170A.039)
AS5538-113G25Mn	3rd WiFi 1x2 BGN	3rd WiFi 1x2 BGN	N	VHP32	VHP32ATDK2ENS3	Nordic (KB.I170A.045)
AS5538-113G25Mn	3rd WiFi 1x2 BGN	3rd WiFi 1x2 BGN	N	VHP32	VHP32ATDK1NO13	Danish (KB.I170A.037)
AS5538-113G25Mn	3rd WiFi 1x2 BGN	3rd WiFi 1x2 BGN	N	VHP32	VHP32ATZA4ENI1	US International (KB.I170A.056)
AS5538-113G25Mn	3rd WiFi 1x2 BGN	3rd WiFi 1x2 BGN	N	VHP32	VHP32ATZA1FR23	French (KB.I170A.039)
AS5538-113G25Mn	3rd WiFi 1x2 BGN	3rd WiFi 1x2 BGN	N	VHP32	VHP32ATZA2EN16	US International (KB.I170A.056)

Model	Wireless LAN	Wireless LAN1	BT	OS	OS-Country Kit	K/B
AS5538-113G32Mn	3rd WiFi 1x2 BGN	3rd WiFi 1x2 BGN	N	VHP32	VHP32ATNO1NO12	Norwegian (KB.I170A.046)
AS5538-114G25Mn	3rd WiFi 1x2 BGN	3rd WiFi 1x2 BGN	N	VHP32	VHP32ATES1ES22	Spanish (KB.I170A.050)
AS5538-114G50Mn	3rd WiFi 1x2 BGN	3rd WiFi 1x2 BGN	N	VHP32	VHP32ATES1ES22	Spanish (KB.I170A.050)
AS5538-312G25Mn	3rd WiFi 1x2 BGN	3rd WiFi 1x2 BGN	BT 2.1	VHP32	VHP32ATME2AR23	Arabic (KB.I170A.032)
AS5538-312G25Mn	3rd WiFi 1x2 BGN	3rd WiFi 1x2 BGN	N	VHB32	VHB32ATHK2Z31	US International (KB.I170A.056)
AS5538-312G25Mn	3rd WiFi 1x2 BGN	3rd WiFi 1x2 BGN	N	VHB32	VHB32ATCN1SC11	US International (KB.I170A.056)
AS5538G-313G32Mn	3rd WiFi 1x2 BGN	3rd WiFi 1x2 BGN	BT 2.1	LINPUS	LINPUSAEU7ENQ1	SLO/CRO (KB.I170A.049)
AS5538G-314G32Mn	3rd WiFi 1x2 BGN	3rd WiFi 1x2 BGN	BT 2.1	LINPUS	LINPUSAME4EN72	Russian (KB.I170A.048)
AS5538G-313G32Mn	3rd WiFi 1x2 BGN	3rd WiFi 1x2 BGN	N	VHP32	VHP32ATGB1EN14	UK (KB.I170A.055)
AS5538G-313G32Mn	3rd WiFi 1x2 BGN	3rd WiFi 1x2 BGN	N	VHP32	VHP32ATUK1RU11	Russian (KB.I170A.048)
AS5538G-313G32Mn	3rd WiFi 1x2 BGN	3rd WiFi 1x2 BGN	N	VHP32	VHP32ATTR1TR33	Turkish (KB.I170A.054)
AS5538G-313G32Mn	3rd WiFi 1x2 BGN	3rd WiFi 1x2 BGN	N	VHP32	VHP32ATME2AR23	Arabic (KB.I170A.032)
AS5538G-313G32Mn	3rd WiFi 1x2 BGN	3rd WiFi 1x2 BGN	N	VHP32	VHP32ATPL1PL11	US International (KB.I170A.056)
AS5538G-313G32Mn	3rd WiFi 1x2 BGN	3rd WiFi 1x2 BGN	N	VHP32	VHP32ATCH1IT42	Swiss/G (KB.I170A.052)
AS5538G-313G32Mn	3rd WiFi 1x2 BGN	3rd WiFi 1x2 BGN	N	VHP32	VHP32ATME4EN11	Russian (KB.I170A.048)
AS5538G-313G32Mn	3rd WiFi 1x2 BGN	3rd WiFi 1x2 BGN	N	VHP32	VHP32ATME4RU61	Russian (KB.I170A.048)
AS5538G-313G32Mn	3rd WiFi 1x2 BGN	3rd WiFi 1x2 BGN	N	VHP32	VHP32ATME2AR13	Arabic (KB.I170A.032)
AS5538G-313G32Mn	3rd WiFi 1x2 BGN	3rd WiFi 1x2 BGN	N	VHP32	VHP32ATME3FR23	French (KB.I170A.039)
AS5538G-313G32Mn	3rd WiFi 1x2 BGN	3rd WiFi 1x2 BGN	N	VHP32	VHP32ATME2EN15	Arabic (KB.I170A.032)
AS5538G-313G32Mn	3rd WiFi 1x2 BGN	3rd WiFi 1x2 BGN	N	VHP32	VHP32ATME6EN15	US International (KB.I170A.056)
AS5538G-313G32Mn	3rd WiFi 1x2 BGN	3rd WiFi 1x2 BGN	N	VHP32	VHP32ATME9FR22	FR/Arabic (KB.I170A.038)
AS5538G-313G32Mn	3rd WiFi 1x2 BGN	3rd WiFi 1x2 BGN	N	VHP32	VHP32ATGR1EL32	Greek (KB.I170A.041)
AS5538G-313G32Mn	3rd WiFi 1x2 BGN	3rd WiFi 1x2 BGN	N	VHP32	VHP32ATIL1HE12	US International w/ Hebrew (KB.I170A.057)
AS5538G-313G32Mn	3rd WiFi 1x2 BGN	3rd WiFi 1x2 BGN	N	VHP32	VHP32ATIT1IT12	Italian (KB.I170A.043)



Model	Wireless LAN	Wireless LAN1	BT	OS	OS-Country Kit	K/B
AS5538G-313G32Mn	3rd WiFi 1x2 BGN	3rd WiFi 1x2 BGN	N	VHP32	VHP32ATFI2FI11	Sweden (KB.I170A.051)
AS5538G-313G32Mn	3rd WiFi 1x2 BGN	3rd WiFi 1x2 BGN	N	VHP32	VHP32ATHU1HU13	Hungarian (KB.I170A.042)
AS5538G-313G32Mn	3rd WiFi 1x2 BGN	3rd WiFi 1x2 BGN	N	VHP32	VHP32ATPT1PT12	Portuguese (KB.I170A.047)
AS5538G-313G32Mn	3rd WiFi 1x2 BGN	3rd WiFi 1x2 BGN	N	VHP32	VHP32ATES1ES22	Spanish (KB.I170A.050)
AS5538G-313G32Mn	3rd WiFi 1x2 BGN	3rd WiFi 1x2 BGN	N	VHP32	VHP32ATEU5RO12	US International (KB.I170A.056)
AS5538G-313G32Mn	3rd WiFi 1x2 BGN	3rd WiFi 1x2 BGN	N	VHP32	VHP32ATEU3RU23	Russian (KB.I170A.048)
AS5538G-313G32Mn	3rd WiFi 1x2 BGN	3rd WiFi 1x2 BGN	N	VHP32	VHP32ATEU5PL13	US International (KB.I170A.056)
AS5538G-313G32Mn	3rd WiFi 1x2 BGN	3rd WiFi 1x2 BGN	N	VHP32	VHP32ATEU7SL11	SLO/CRO (KB.I170A.049)
AS5538G-313G32Mn	3rd WiFi 1x2 BGN	3rd WiFi 1x2 BGN	N	VHP32	VHP32ATEU7ENR2	SLO/CRO (KB.I170A.049)
AS5538G-313G32Mn	3rd WiFi 1x2 BGN	3rd WiFi 1x2 BGN	N	VHP32	VHP32ATEU4SV22	Sweden (KB.I170A.051)
AS5538G-313G32Mi	3rd WiFi 1x2 BGN	3rd WiFi BG	N	VHP32	VHP32ATRU1RU11	Russian (KB.I170A.048)
AS5538G-313G32Mn	3rd WiFi 1x2 BGN	3rd WiFi 1x2 BGN	N	VHP32	VHP32ATAT1DE11	German (KB.I170A.040)
AS5538G-313G32Mn	3rd WiFi 1x2 BGN	3rd WiFi 1x2 BGN	N	VHP32	VHP32ATSE1FI13	Sweden (KB.I170A.051)
AS5538G-313G32Mn	3rd WiFi 1x2 BGN	3rd WiFi 1x2 BGN	N	VHP32	VHP32ATCZ2SK12	CZ/SK (KB.I170A.035)
AS5538G-313G32Mn	3rd WiFi 1x2 BGN	3rd WiFi 1x2 BGN	N	VHP32	VHP32ATNO3ENS3	Nordic (KB.I170A.045)
AS5538G-313G32Mn	3rd WiFi 1x2 BGN	3rd WiFi 1x2 BGN	N	VHP32	VHP32ATNO3ENS4	Nordic (KB.I170A.045)
AS5538G-313G32Mn	3rd WiFi 1x2 BGN	3rd WiFi 1x2 BGN	N	VHP32	VHP32ATNO1NO12	Norwegian (KB.I170A.046)
AS5538G-313G32Mn	3rd WiFi 1x2 BGN	3rd WiFi 1x2 BGN	N	VHP32	VHP32ATBE1NL13	Belgium (KB.I170A.033)
AS5538G-313G32Mn	3rd WiFi 1x2 BGN	3rd WiFi 1x2 BGN	N	VHP32	VHP32ATNL1NL12	US International (KB.I170A.056)
AS5538G-313G32Mn	3rd WiFi 1x2 BGN	3rd WiFi 1x2 BGN	N	VHP32	VHP32ATLU3IT41	Swiss/G (KB.I170A.052)
AS5538G-313G32Mn	3rd WiFi 1x2 BGN	3rd WiFi 1x2 BGN	N	VHP32	VHP32ATDK1NO13	Danish (KB.I170A.037)
AS5538G-313G32Mn	3rd WiFi 1x2 BGN	3rd WiFi 1x2 BGN	N	VHP32	VHP32ATDK2ENS3	Nordic (KB.I170A.045)
AS5538G-313G32Mn	3rd WiFi 1x2 BGN	3rd WiFi 1x2 BGN	N	VHP32	VHP32ATFR1FR23	French (KB.I170A.039)
AS5538G-313G32Mn	3rd WiFi 1x2 BGN	3rd WiFi 1x2 BGN	N	VHP32	VHP32ATDE1DE13	German (KB.I170A.040)
AS5538G-313G32Mn	3rd WiFi 1x2 BGN	3rd WiFi 1x2 BGN	N	VHP32	VHP32ATZA4ENI1	US International (KB.I170A.056)



Model	Wireless LAN	Wireless LAN1	BT	OS	OS-Country Kit	K/B
AS5538G-313G32Mn	3rd WiFi 1x2 BGN	3rd WiFi 1x2 BGN	N	VHP32	VHP32ATZA1FR23	French (KB.I170A.039)
AS5538G-313G32Mn	3rd WiFi 1x2 BGN	3rd WiFi 1x2 BGN	N	VHP32	VHP32ATZA2EN16	US International (KB.I170A.056)
AS5538G-313G32Mn	3rd WiFi 1x2 BGN	3rd WiFi 1x2 BGN	N	VHP32	VHP32ATNO1NO12	Norwegian (KB.I170A.046)
AS5538G-312G32Mn	3rd WiFi 1x2 BGN	3rd WiFi 1x2 BGN	BT 2.1	VHP32	VHP32ATHK2ZH31	US International (KB.I170A.056)
AS5538G-312G32Mn	3rd WiFi 1x2 BGN	3rd WiFi 1x2 BGN	BT 2.1	VHP32	VHP32ATCN1SC11	US International (KB.I170A.056)
AS5538G-313G32Mn	3rd WiFi 1x2 BGN	3rd WiFi 1x2 BGN	BT 2.1	VHP32	VHP32ATME2AR23	Arabic (KB.I170A.032)
AS5538G-314G32Mn	3rd WiFi 1x2 BGN	3rd WiFi 1x2 BGN	N	VHP32	VHP32ATES1ES22	Spanish (KB.I170A.050)
AS5538-111G25Mn	3rd WiFi 1x2 BGN	3rd WiFi 1x2 BGN	N	VHB32	VHB32ATHK2ZH31	US International (KB.I170A.056)
AS5538-111G25Mn	3rd WiFi 1x2 BGN	3rd WiFi 1x2 BGN	N	VHB32	VHB32ATCN1SC11	US International (KB.I170A.056)
AS5538-312G25Mn	3rd WiFi 1x2 BGN	3rd WiFi 1x2 BGN	BT 2.1	LINPUS	LINPUSAWW1ENX1	US International (KB.I170A.056)
AS5538-312G25Mn	3rd WiFi 1x2 BGN	3rd WiFi 1x2 BGN	BT 2.1	LINPUS	LINPUSAWW1EN11	US International (KB.I170A.056)
AS5538G-312G25Mn	3rd WiFi 1x2 BGN	3rd WiFi 1x2 BGN	BT 2.1	LINPUS	LINPUSAWW1EN11	US International (KB.I170A.056)
AS5538-312G25Mn	3rd WiFi 1x2 BGN	3rd WiFi 1x2 BGN	BT 2.1	LINPUS	LINPUSAWW1EN11	US International (KB.I170A.056)



# Test Compatible Components

---

This computer's compatibility is tested and verified by Acer's internal testing department. All of its system functions are tested under Windows® XP Home, Windows® XP Pro environment.

Refer to the following lists for components, adapter cards, and peripherals which have passed these tests. Regarding configuration, combination and test procedures, please refer to the Aspire 5538 series Compatibility Test Report released by the Acer Mobile System Testing Department.

# Windows XP Environment Test

Vendor	Type	Description
<b>Adapter</b>		
DELTA	65W	Adapter DELTA 65W 19V 1.7x5.5x11 Yellow (ADP-65MH B A) LV5, Timeline LF LF
HIPRO	65W	Adapter HIPRO 65W 19V 1.7x5.5x11 Yellow (HP-A0653R3B 1LF), LV5 Timeline LF
LITE-ON	65W	Adapter LITE-ON 65W 19V 1.7x5.5x11 Yellow (PA-1650-22AG), LV5 Timeline LF
<b>Audio Codec</b>		
Realtek	ALC269X	Realtek Audio Codec ALC269X
<b>Battery</b>		
PANASONIC	6CELL2.2	Battery PANASONIC AS-2009D Li-Ion 3S2P PANASONIC 6 cell 4400mAh Main COMMON ID: AS09D51 W/ Halogen Free
PANASONIC	6CELL2.2	Battery PANASONIC AS-2009D Li-Ion 3S2P PANASONIC 6 cell 4400mAh Main COMMON ID: AS09D51 W/ Halogen Free
SANYO	6CELL2.2	Battery SANYO AS-2009D Li-Ion 3S2P SANYO 6 cell 4400mAh Main COMMON AS09D31
SANYO	6CELL2.2	Battery SANYO AS-2009D Li-Ion 3S2P SANYO 6 cell 4400mAh Main COMMON ID: AS09D31 W/ Halogen Free
SIMPLO	6CELL2.2	Battery SIMPLO AS-2009D Li-Ion 3S2P LGC 6 cell 4400mAh Main COMMON 2.2S3, ID: AS09D73 W/ Halogen Free
SIMPLO	6CELL2.2	Battery SIMPLO AS-2009D Li-Ion 3S2P LGC 6 cell 4400mAh Main COMMON AS09D73
SIMPLO	6CELL2.2	Battery SIMPLO AS-2009D Li-Ion 3S2P SAMSUNG 6 cell 4400mAh Main COMMON AS09D75
SIMPLO	6CELL2.2	Battery SIMPLO AS-2009D Li-Ion 3S2P PANASONIC 6 cell 4400mAh Main COMMON 2.2CG, ID: AS09D71 W/ Halogen Free
SIMPLO	6CELL2.2	Battery SIMPLO AS-2009D Li-Ion 3S2P PANASONIC 6 cell 4400mAh Main COMMON 2.2CG, ID: AS09D71 W/ Halogen Free
SONY	6CELL2.2	Battery SONY AS-2009D Li-Ion 3S2P SONY 6 cell 4400mAh Main COMMON ID: AS09D41 W/ Halogen Free
SONY	6CELL2.2	Battery SONY AS-2009D Li-Ion 3S2P SONY 6 cell 4400mAh Main COMMON ID: AS09D41 W/ Halogen Free
<b>Bluetooth</b>		
Foxconn	BT 2.1	Foxconn Bluetooth BRM 2046 BT2.1 (T60H928.33) f/w:861
<b>Camera</b>		
Suyin	0.3M LDV	Suyin Camera Rose_2G
<b>Card Reader</b>		
	5 in 1-Build in	5 in 1-Build in MS, MS Pro, SD, SC, XD

Vendor	Type	Description
<b>CPU</b>		
AMD	AAL110	CPU AMD Athlon L110 PGA 1.2G 512K single core
AMD	AAL310	CPU AMD Athlon L310 PGA 1.2G 1M Dual Core
AMD	AATF20	CPU AMD Athlon TF20 PGA 1.6G 512K 638 15W G2
<b>HDD</b>		
HGST	N160GB5.4K S	HDD HGST 2.5" 5400rpm 160GB HTS545016B9A300 Panther B SATA LF F/W:C60F
HGST	N250GB5.4K S	HDD HGST 2.5" 5400rpm 250GB HTS545025B9A300 Panther B SATA LF F/W:C60F
HGST	N320GB5.4K S	HDD HGST 2.5" 5400rpm 320GB HTS545032B9A300 Panther B SATA LF F/W:C60F
HGST	N500GB5.4K S	HDD HGST 2.5" 5400rpm 500GB HTS545050B9A300 Panther B SATA LF F/W:C60F
SEAGATE	N160GB5.4K S	HDD SEAGATE 2.5" 5400rpm 160GB ST9160310AS Crockett SATA LF F/W:0303
SEAGATE	N250GB5.4K S	HDD SEAGATE 2.5" 5400rpm 250GB ST9250315AS Wyatt SATA LF F/W:0001SDM1
SEAGATE	N320GB5.4K S	HDD SEAGATE 2.5" 5400rpm 320GB ST9320320AS Crockett SATA LF F/W:0303
SEAGATE	N500GB5.4K S	HDD SEAGATE 2.5" 5400rpm 500GB ST9500325AS Wyatt SATA LF F/W:0001SDM1
TOSHIBA	N160GB5.4K S	HDD TOSHIBA 2.5" 5400rpm 160GB MK1655GSX Libra SATA LF F/W: FG011J
TOSHIBA	N250GB5.4K S	HDD TOSHIBA 2.5" 5400rpm 250GB MK2555GSX Libra SATA LF F/W:FG001J
TOSHIBA	N320GB5.4K S	HDD TOSHIBA 2.5" 5400rpm 320GB MK3255GSX Libra SATA LF F/W:FG011J
TOSHIBA	N500GB5.4K S	HDD TOSHIBA 2.5" 5400rpm 500GB MK5055GSX Libra SATA LF F/W:FG001J
WD	N160GB5.4K S	HDD WD 2.5" 5400rpm 160GB WD1600BEVT-22ZCT0 ML160 SATA LF F/W:11.01A11
WD	N250GB5.4K S	HDD WD 2.5" 5400rpm 250GB WD2500BEVT-22ZCT0 ML160 SATA LF F/W:11.01A11
WD	N320GB5.4K S	HDD WD 2.5" 5400rpm 320GB WD3200BEVT-22ZCT0 ML160 SATA LF F/W:11.01A11
WD	N500GB5.4K S	HDD WD 2.5" 5400rpm 500GB WD5000BEVT-22ZAT0 ML250 SATA LF F/W:01.01A01
<b>Keyboard</b>		
ACER	AC7T	Keyboard ACER AC7T JV50 Internal 17 Standard Black Texture
<b>LAN</b>		
Realtek	RTL8111CA	Realtek RTL8111CA
<b>LCD</b>		

Vendor	Type	Description
AUO	NLED15.6WX GAGS	LED LCD AUO 15.6"W WXGA Glare B156XW03 V1 LF 220nit 8ms 500:1
LPL	NLED15.6WX GAGS	LED LCD LPL 15.6"W WXGA Glare LP156WH3- TLA1 LF 200nit 8ms 500:1
SAMSUNG	NLED15.6WX GAGS	LED LCD SAMSUNG 15.6"W WXGA Glare LTN156AT07-A01 LF 200nit 16ms
<b>Memory</b>		
HYNIX	SO1GBII6	Memory HYNIX SO-DIMM DDRII 667 1GB HYMP112S64CP6-Y5 LF
HYNIX	SO2GBII6	Memory HYNIX SO-DIMM DDRII 667 2GB HYMP125S64CP8-Y5 LF
NANYA	SO1GBII6	Memory NANYA SO-DIMM DDRII 667 1GB NT1GT64UH8D0FN-3C LF 64*16 0.07um
NANYA	SO2GBII6	Memory NANYA SO-DIMM DDRII 667 2GB NT2GT64U8HD0BN-3C LF 128*8 0.07um
SAMSUNG	SO1GBII6	Memory SAMSUNG SO-DIMM DDRII 667 1GB M470T2864EH3-CE6 LF 64*16 0.055um
SAMSUNG	SO2GBII6	Memory SAMSUNG SO-DIMM DDRII 667 2GB M470T5663EH3-CE6 LF 128*8 0.055um
<b>NB Chipset</b>		
AMD	AMDRS780M N	AMD RS780MN w/ HDCP EEPROM
<b>ODD</b>		
HLDS	NSM8XS9.5	ODD HLDS Super-Multi DRIVE 9.5mm Tray DL 8X GU10N LF W/O bezel SATA GBAS2.0, HF
PANASONIC	NSM8XS9.5	ODD PANASONIC Super-Multi DRIVE 9.5mm Tray DL 8X UJ892 LF W/O bezel SATA GBAS2.0, HF
<b>SB Chipset</b>		
AMD	AMDSB710	AMD SB710
<b>VGA Chip</b>		
None	UMA	UMA (AMD)
<b>VRAM</b>		
	512M-DDR3 (64*16*4)	512M-DDR3 64*16*4
<b>WiFi Antenna</b>		
WNC	PIFA	PIFA
<b>Wireless LAN</b>		
Foxconn	3rd WiFi 1x2 BGN	Foxconn Wireless LAN Atheros AR5B91 1x2 BGN
Foxconn	3rd WiFi 1x2 BGN	Foxconn Wireless LAN Atheros AR5B91 1x2 BGN
Foxconn	3rd WiFi 1x2 BGN	Foxconn Wireless LAN Wireless LAN Ralink RT2700E 1x2 BGN
QMI	3rd WiFi 1x2 BGN	QMI Wireless LAN Atheros AR5B91 1x2 BGN (EM303)

# Online Support Information

---

This section describes online technical support services available to help you repair your Acer Systems.

If you are a distributor, dealer, ASP or TPM, please refer your technical queries to your local Acer branch office. Acer Branch Offices and Regional Business Units may access our website. However some information sources will require a user i.d. and password. These can be obtained directly from Acer CSD Taiwan.

Acer's Website offers you convenient and valuable support resources whenever you need them.

In the Technical Information section you can download information on all of Acer's Notebook, Desktop and Server models including:

- Service guides for all models
- User's manuals
- Training materials
- Bios updates
- Software utilities
- Spare parts lists
- TABs (Technical Announcement Bulletin)

For these purposes, we have included an Acrobat File to facilitate the problem-free downloading of our technical material.

Also contained on this website are:

- Detailed information on Acer's International Traveler's Warranty (ITW)
- Returned material authorization procedures
- An overview of all the support services we offer, accompanied by a list of telephone, fax and email contacts for all your technical queries.

We are always looking for ways to optimize and improve our services, so if you have any suggestions or comments, please do not hesitate to communicate these to us.



**A**

- Antennas
  - Removing 100
  - Replacing 102

**B**

- Battery
  - Replacing 145
- Battery Pack
  - Removing 45
- BIOS
  - ROM type 19
  - vendor 19
  - Version 19
- BIOS Utility 23–34
  - Advanced 28
  - Boot 32
  - Exit 33
  - Navigating 23
  - Power 31
  - Save and Exit 33
  - Security 28
  - System Security 33
- Board Layout
  - Top View 173
- brightness
  - hotkeys 13
- Button Board
  - Removing 66
  - Replacing 128

**C**

- Camera Board
  - Removing 93
  - Replacing 108
- caps lock
  - on indicator 9
- CPU
  - Removing 88
  - Replacing 113
- CPU Fan
  - Replacing 115

**D**

- DC-In Cable

- Removing 79
- DIMM Module
  - Removing 52
  - Replacing 137
- Display 4
- display
  - hotkeys 13

**E**

- Euro Key 14
- External Module Disassembly
  - Flowchart 44

**F**

- Fan
  - Removing 85
  - Replacing 115
- Features 1
- FLASH Utility 34
- Flash Utility 34
- FPC Cable
  - Removing 95
  - Replacing 106
- FRU (Field Replaceable Unit) List 177

**H**

- Hard Disk Drive Module
  - Removing 46
  - Replacing 139
- Heatsink Fan 85
- Hibernation mode
  - hotkey 13
- Hot Keys 11

**I**

- I/O Board
  - Removing 76
  - Replacing 120
- Indicators 9
- Intermittent Problems 164
- Internal Microphone Failure 155
- Internal Power Cable 79

---

Internal Speaker Failure 153

## J

Jumper and Connector Locations 173  
Top View 173

## K

Keyboard  
Removing 60  
Replacing 134  
Keyboard Failure 152

## L

LCD Bezel  
Removing 90  
Replacing 109  
LCD Brackets  
Removing 97  
Replacing 105  
LCD Cable  
Removing 95, 106  
LCD Failure 152  
LCD Module  
Disassembly 89  
Reassembly 102  
Removing 83  
Replacing 111  
LCD Module Disassembly  
Flowchart 89  
LCD Panel  
Removing 94  
Replacing 107  
Lower Covers  
Replacing 143

## M

Main Unit Disassembly  
Flowchart 58  
Mainboard  
Removing 80  
Replacing 117  
media access  
on indicator 9  
Media Board  
Removing 74  
Replacing 122  
Microphone

Removing 98  
Replacing 103

Model Definition 190

## N

No Display Issue 150  
num lock  
on indicator 9

## O

ODD  
Replacing 141  
Online Support Information 210  
optical drive module 49

## P

Panel 5  
left 5  
PC Card 9  
Power Board  
Removing 70  
Replacing 125

## S

Speaker Module  
Replacing 123  
Speaker Modules  
Removing 72  
speakers  
hotkey 13  
System  
Block Diagram 4

## T

Test Compatible Components 206  
Thermal Module  
Removing 87  
Replacing 113  
Thermal Unit Failure 163  
Top 173  
Touchpad Bracket  
Removing 68  
Replacing 126  
Touchpad Failure 153  
Troubleshooting

---

- Built-in KB Failure 152
- Internal Microphone 155
- Internal Speakers 153
- LCD Failure 152
- No Display 150
- Other Failures 164
- Thermal Unit 163
- Touchpad 153
- USB 160
- WLAN 161

## U

- Undetermined Problems 165
- Upper Cover
  - Removing 62
  - Replacing 130
- USB Failure (Rightside) 160
- utility
  - BIOS 23–34

## V

- volume
  - hotkeys 13

## W

- Windows 2000 Environment Test 206
- Wireless Function Failure 161
- WLAN Antennas
  - Removing 100
  - Replacing 102
- WLAN Board
  - Removing 55
  - Replacing 136

