

Aspire 7740 and 7740G Series Service Guide

Service guide files and updates are available on the ACER/CSD web; for more information, please refer to <http://csd.acer.com.tw>

PRINTED IN TAIWAN

Revision History

Please refer to the table below for the updates made on Aspire 7740 and 7740G Series service guide.

Date	Chapter	Updates

Copyright

Copyright © 2009 by Acer Incorporated. All rights reserved. No part of this publication may be reproduced, transmitted, transcribed, stored in a retrieval system, or translated into any language or computer language, in any form or by any means, electronic, mechanical, magnetic, optical, chemical, manual or otherwise, without the prior written permission of Acer Incorporated.

Disclaimer

The information in this guide is subject to change without notice.

Acer Incorporated makes no representations or warranties, either expressed or implied, with respect to the contents hereof and specifically disclaims any warranties of merchantability or fitness for any particular purpose. Any Acer Incorporated software described in this manual is sold or licensed "as is". Should the programs prove defective following their purchase, the buyer (and not Acer Incorporated, its distributor, or its dealer) assumes the entire cost of all necessary servicing, repair, and any incidental or consequential damages resulting from any defect in the software.

Acer is a registered trademark of Acer Corporation.

Intel is a registered trademark of Intel Corporation.

Other brand and product names are trademarks and/or registered trademarks of their respective holders.

Conventions

The following conventions are used in this manual:

SCREEN MESSAGES	Denotes actual messages that appear on screen.
NOTE	Gives bits and pieces of additional information related to the current topic.
WARNING	Alerts you to any damage that might result from doing or not doing specific actions.
CAUTION	Gives precautionary measures to avoid possible hardware or software problems.
IMPORTANT	Reminds you to do specific actions relevant to the accomplishment of procedures.

Preface

Before using this information and the product it supports, please read the following general information.

1. This Service Guide provides you with all technical information relating to the BASIC CONFIGURATION decided for Acer's "global" product offering. To better fit local market requirements and enhance product competitiveness, your regional office MAY have decided to extend the functionality of a machine (e.g. add-on card, modem, or extra memory capability). These LOCALIZED FEATURES will NOT be covered in this generic service guide. In such cases, please contact your regional offices or the responsible personnel/channel to provide you with further technical details.
2. Please note WHEN ORDERING FRU PARTS, that you should check the most up-to-date information available on your regional web or channel. If, for whatever reason, a part number change is made, it will not be noted in the printed Service Guide. For ACER-AUTHORIZED SERVICE PROVIDERS, your Acer office may have a DIFFERENT part number code to those given in the FRU list of this printed Service Guide. You MUST use the list provided by your regional Acer office to order FRU parts for repair and service of customer machines.

System Specifications	1
Features	1
System Block Diagram	4
Your Acer Notebook tour	5
Top View	5
Hotkeys	6
Closed Front View	7
Rear View	7
Left View	7
Right View	8
Base View	8
Indicators	9
Easy-Launch Buttons	9
Touchpad Basics	9
Using the Keyboard	10
Lock Keys and numeric keypad	10
Windows Keys	11
Special Key (only for certain models)	11
Windows Mobility Center	12
Using the System Utilities	13
Acer GridVista (dual-display compatible)	13
Hardware Specifications and Configurations	15
 System Utilities	 23
BIOS Setup Utility	23
Navigating the BIOS Utility	24
Information	25
Main	26
Security	28
Boot	32
Exit	33
BIOS Flash Utility	34
Remove HDD Password	35
 Machine Disassembly and Replacement	 37
Disassembly Requirements	37
General Information	38
Pre-disassembly Instructions	38
Disassembly Process	38
External Module Disassembly Process	39
External Modules Disassembly Flowchart	39
Removing the Battery Pack	40
Removing the Optical Drive Module	41
Removing the Back Cover	42
Removing the Hard Disk Drive Module	43
Removing the Wireless LAN Card	44
Removing the DIMM Module	46
Main Unit Disassembly Process	48
Main Unit Disassembly Flowchart	48
Removing the Heatsink Module	49
Removing the CPU	51
Removing the Middle Cover	53
Removing the Keyboard	53
Removing the LCD Module	55

Table of Contents

Separating the Upper Case from the Lower Case	58
Removing the Touchpad and Button Boards	61
Removing the Left Speaker	66
Removing the USB Board Module	67
Removing the Modem Board	70
Removing the Bluetooth Module	71
Removing the Microphone	72
Removing the Main Board	74
Removing the Right Speaker	77
LCD Module Disassembly Process	79
LCD Module Disassembly Flowchart	79
Removing the LCD Bezel	80
Removing the LCD panel with the Brackets	81
Removing the LCD Brackets	84
Removing the FPC Cable	85
Removing the Web Camera	86
Removing the Antennas	88
Troubleshooting	89
System Check Procedures	90
External Diskette Drive Check	90
External Optical Disk Drive Check	90
Keyboard or Auxiliary Input Device Check	90
Memory Check	91
Power System Check	91
Touchpad Check	92
Power-On Self-Test (POST) Error Message	92
Index of Error Messages	93
Phoenix BIOS Beep Codes	97
Index of Symptom-to-FRU Error Message	101
Intermittent Problems	104
Undetermined Problems	104
Connector Locations	105
Main Board	105
Clearing Password Check and BIOS Recovery	107
Clearing Password Check	107
BIOS Recovery by Crisis Disk	108
FRU (Field Replaceable Unit) List	113
Exploded Diagram	114
Model Definition and Configuration	125
Aspire 7740/7740G Series	126
Test Compatible Components	147
Hardware Device Tests	148
Online Support Information	151
Index	153

System Specifications

Features

Below is a brief summary of the computer's many features:

Platform

- Intel® Core i7 processor*
- Intel® Core i5 processor*
- Intel® Core i3 processor*
- Mobile Intel® HM55 Express Chipset
- Acer InviLink™ Nplify™ 802.11b/g/Draft-N*
- Acer InviLink™ 802.11b/g*

System Memory

- Dual-Channel SDRAM support
- Up to 4 GB of DDR3 1066 MHz memory, upgradeable to 8 GB using two soDIMM modules*

Display

- 16:9 aspect ratio
- 17.3" HD+ 1600 x 900

Graphics

- ATI Mobility Radeon™ HD 5650*
- ATI Mobility Radeon™ HD 5470*
- Integrated Intel® Graphics Media Accelerator (GMA) HD
- Screen resolution support

For UMA

- 1600*900
- 1440*900
- 1366*768
- 1360*768
- 1280*800
- 1280*768
- 1280*720
- 1152*864
- 1024*768
- 800*600

For Discrete

- 1600*900
- 1280*768
- 1280*720

-
- 1024*768
 - 800*600

Storage subsystem

- 2.5" hard disk drive
- Optical drive options:
 - Blu-ray Disc™/DVD-Super Multi double-layer drive*
 - DVD-Super Multi double-layer drive*
- Multi-in-1 card reader

Special keys and controls

- 103-/104-/107-key keyboard
- Touchpad pointing device

Audio

- Dolby®-optimized surround sound system with two built-in stereo speakers
- True 5.1-channel surround sound output
- High-definition audio support
- S/PDIF (Sony/Philips Digital Interface) support for digital speakers
- MS-Sound compatible
- Built-in microphones

Communication

- Integrated Acer Crystal Eye webcam*
- WLAN:
 - Intel® Centrino® Advanced-N 6200 802.11a/g/n*
 - Intel® Centrino® Wireless-N 1000 802.11b/g/n*
 - Acer InviLink™ Nplify™ 802.11b/g/n*
 - Acer InviLink™ 802.11b/g*
- WPAN: Bluetooth® 2.1+Enhanced Data Rate (EDR)*
- LAN: Gigabit Ethernet; Wake-on-LAN ready
- Modem: 56K ITU V.92; Wake-on-Ring ready

I/O Ports

- Multi-in-1 card reader (SD/MMC/MS/MS PRO/xD)
- USB 2.0 port
- HDMI™ port with HDCP support
- External display (VGA) port
- Headphones/speaker/line-out jack with S/PDIF support
- Microphone-in jack
- Line-in jack
- Ethernet (RJ-45) port
- Modem (RJ-11) port
- DC-in jack for AC adapter

Environment

- Temperature:
 - Operating: 5 °C to 35 °C
 - Non-operating: -20 °C to 65 °C
- Humidity (non-condensing):
 - Operating: 20% to 80%
 - Non-operating: 20% to 80%

Dimension and Weight

- Dimension: 411 (W) x 274 (D) x 40/45.0 (H) mm
(16.18 x 10.78 x 1.58/1.77 inches)
- Weight: 3.2 kg (7.05 lbs.) with 6-cell battery pack*
3.26 kg (7.19 lbs.) with 8-cell battery pack*

NOTE: 1. "*" means only for certain models".

2. The specifications listed above are for reference only. The exact configuration of your PC depends on the model purchased.

System Block Diagram

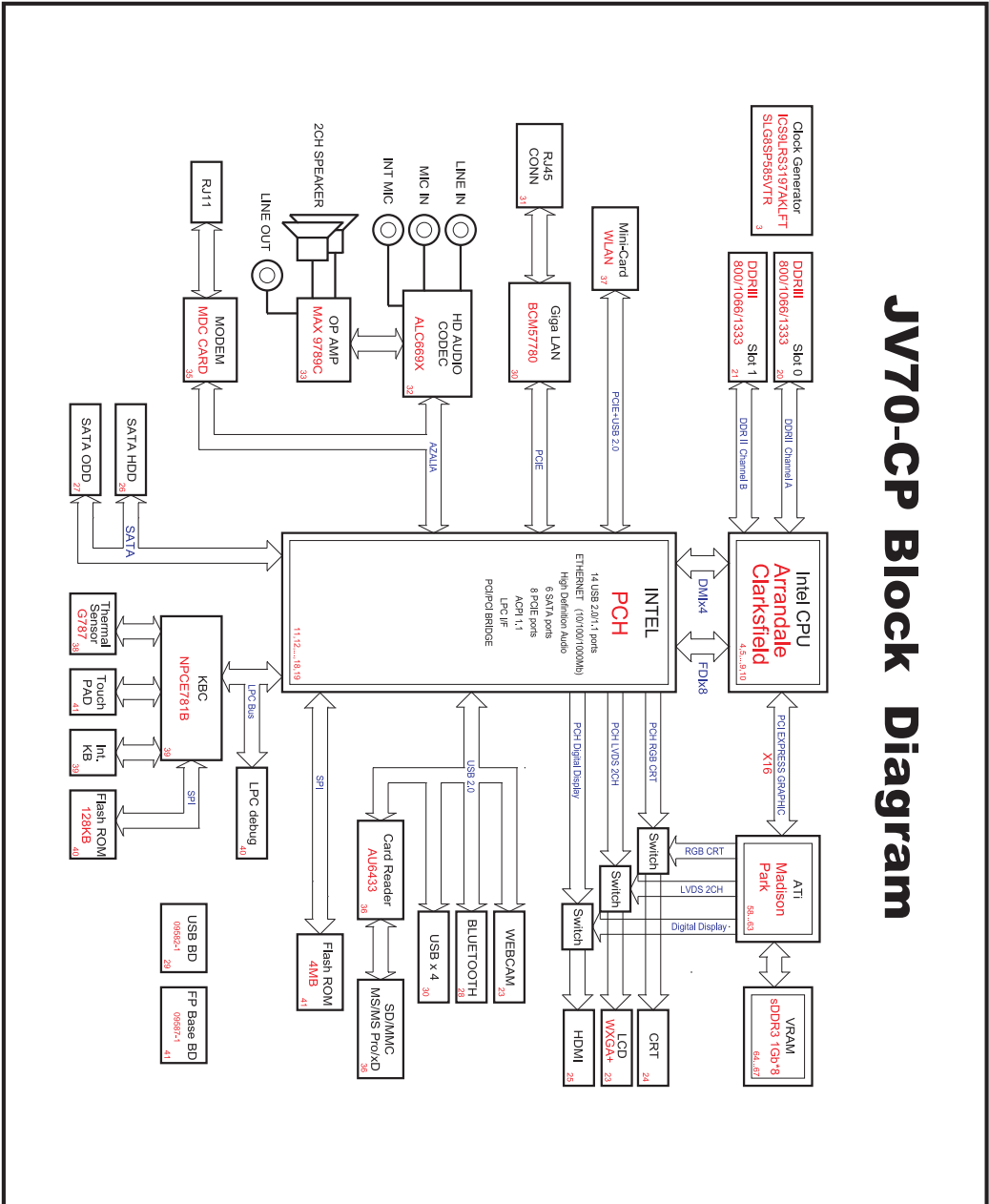



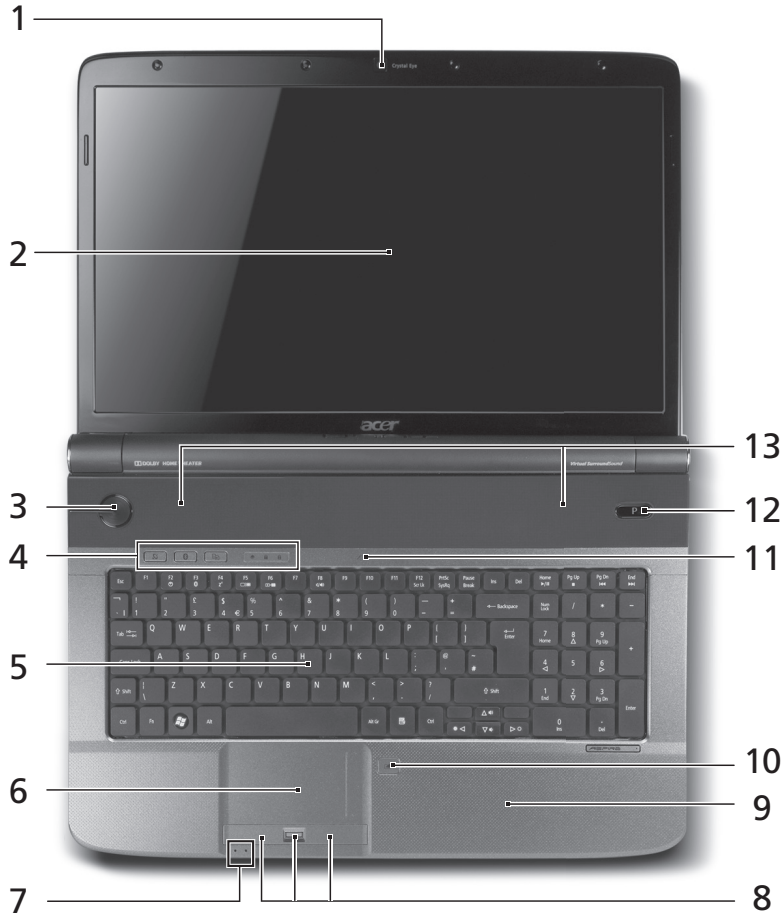

Your Acer Notebook tour

After knowing your computer features, let us show you around your new computer.

Top View













#	Icon	Item	Description
1		Acer Crystal Eye webcam	Web camera for video communication. (only for certain models)
2		Display screen	Also called Liquid-Crystal Display (LCD), displays computer output (Configuration may vary by models).
3		Power button	Turns the computer on and off.
4		Wireless LAN communication button/indicator	Enables/disables the wireless LAN function. Indicates the status of wireless LAN communication.
		Bluetooth communication button/indicator	Enables/disables the Bluetooth function. Indicates the status of Bluetooth communication. (only for certain models)
		Backup key	Launches Acer Backup Management for three-step data backup.
		HDD	Indicates when the hard disk drive is active.
		Num Lock	Lights up when Num Lock is activated.
		Caps Lock	Lights up when Caps Lock is activated.
	5		Keyboard

#	Icon	Item	Description
6		Touchpad	Touch-sensitive pointing device which functions like a computer mouse.
7		Power ¹	Indicates the computer's power status.
		Battery ¹	Indicates the computer's battery status. 1. Charging: The light shows amber when the battery is charging. 2. Fully charged: The light shows blue when in AC mode.
8		Click buttons (left, center* and right)	The left and right buttons function like the left and right mouse buttons. *The center button serves as Acer Bio-Protection fingerprint reader supporting Acer FingerNav 4-way control function (only for certain models).
9		Palmrest	Comfortable support area for your hands when you use the computer.
10		Touchpad toggle	Turns the internal touchpad on and off.
11		Microphone	Internal microphone for sound recording.
12		Programmable key	User-programmable.
13		Speakers	Left and right speakers deliver stereo audio output.

Hotkeys

The computer employs hotkeys or key combinations to access most of the computer's controls like screen brightness and volume output.

To activate hotkeys, press and hold the <Fn> key before pressing the other key in the hotkey combination.

Hotkey	Icon	Function	Description
<Fn> + <F2>		System property	Starts System Property for displaying system information.
<Fn> + <F3>		Bluetooth	Enables/disables the Bluetooth function. (only for certain models)
<Fn> + <F4>		Sleep	Puts the computer in Sleep mode.
<Fn> + <F5>		Display toggle	Switches display output between the display screen, external monitor (if connected) and both.
<Fn> + <F6>		Screen blank	Turns the display screen backlight off to save power. Press any key to return.
<Fn> + <F8>		Speaker toggle	Turns the speakers on and off.
<Fn> + <D>		Brightness up	Increases the screen brightness.
<Fn> + <D>		Brightness down	Decreases the screen brightness.
<Fn> + <U>		Volume up	Increases the sound volume.
<Fn> + <U>		Volume down	Decreases the sound volume.

Closed Front View



#	Icon	Item	Description
1		Multi-in-1 card reader	Accepts Secure Digital (SD), MultiMediaCard (MMC), Memory Stick (MS), Memory Stick PRO (MS PRO), xD-Picture Card (xD). Note: Push to remove/install the card. Only one card can operate at any given time.







Rear View

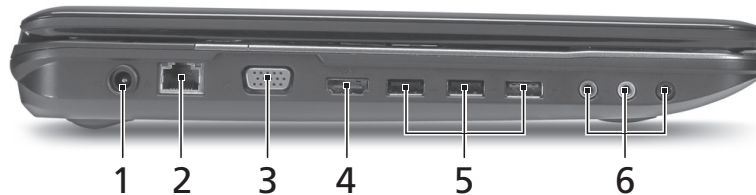

#	Item	Description
1	Ventilation slots	Enable the computer to stay cool, even after prolonged use.



Left View



#	Icon	Item	Description
1		DC-in jack	Connects to an AC adapter.
2		Ethernet (RJ-45) port	Connects to an Ethernet 10/100/1000-based network.
3		External display (VGA) port	Connects to a display device (e.g., external monitor, LCD projector).
4	HDMI	HDMI port	Supports high definition digital video connections.
5		USB 2.0 port	Connect to USB 2.0 devices (e.g., USB mouse, USB camera).
6		Line-in jack	Accepts audio line-in devices (e.g., audio CD player, stereo walkman, mp3 player)
		Microphone jack	Accepts inputs from external microphones.
		Headphones/speaker/line-out jack with S/PDIF support	Connects to audio line-out devices (e.g., speakers, headphones).

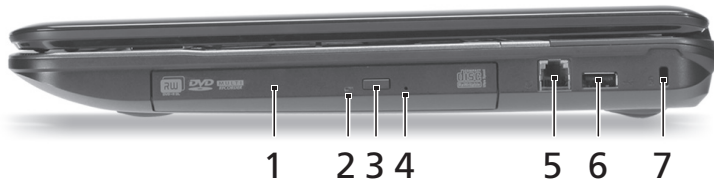



Right View

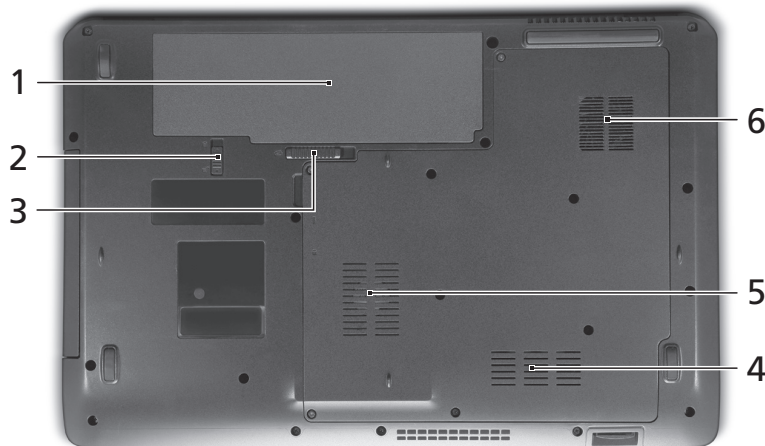

#	Icon	Item	Description
1		Optical drive	Internal optical drive; accepts CDs or DVDs.
2		Optical disk access indicator	Lights up when the optical drive is active.
3		Optical drive eject button	Ejects the optical disk from the drive.
4		Emergency eject hole	Ejects the optical drive tray when the computer is turned off. Note: Insert a paper clip to the emergency eject hole to eject the optical drive tray when the computer is off.
5		Modem (RJ-11) port	Connects to a phone line.
6		USB 2.0 port	Connect to USB 2.0 devices (e.g., USB mouse, USB camera).
7		Kensington lock slot	Connects to a Kensington-compatible computer security lock.

Base View







#	Icon	Item	Description
1		Battery bay	Houses the computer's battery pack.
2		Battery lock	Locks the battery in position.
3		Battery release latch	Releases the battery for removal.
4		Memory compartment	Houses the computer's main memory.
5		Hard disk bay	Houses the computer's hard disk (secured with screws).

#	Icon	Item	Description
6		Ventilation slots and cooling fan	Enable the computer to stay cool, even after prolonged use. Note: Do not cover or obstruct the opening of the fan.

Indicators



The computer has several easy-to-read status indicators.

Icon	Function	Description
	Power	Indicates the computer's power status.
	Battery	Indicates the computer's battery status. 1. Charging: The light shows amber when the battery is charging. 2. Fully charged: The light shows blue when in AC mode.
	Power button / indicator	Turns the computer on and off. / Indicates the computer's power status.
	HDD	Indicates when the hard disk drive is active.

NOTE: 1. **Charging:** The light shows amber when the battery is charging. 2. **Fully charged:** The light shows green when in AC mode.

Easy-Launch Buttons

Located on the left of the keyboard are the application buttons. These buttons are called easy-launch buttons. They are: WLAN, Bluetooth and Backup.

Icon	Function	Description
	Wireless LAN communication button/indicator	Enables/disables the wireless LAN function. Indicates the status of wireless LAN communication.
	Bluetooth communication button/indicator	Enables/disables the Bluetooth function. Indicates the status of Bluetooth communication. (only for certain models)
	Backup key	Launches Acer Backup Management for three-step data backup.

Touchpad Basics

The following items show you how to use the touchpad with two-click buttons.

- Move your finger across the touchpad **(1)** to move the cursor.
- Press the left **(2)** and right **(3)** buttons located beneath the touchpad to perform selection and execution functions. These two buttons are similar to the left and right buttons on a mouse. Tapping on the touchpad is the same as clicking the left button.

Function	Left button (2)	Right button (3)	Main touchpad (1)	Function
Execute	Quickly click twice.		Tap twice (at the same speed as double-clicking a mouse button).	Execute
Select	Click once.		Tap once.	Select
Drag	Click and hold, then use finger on the touchpad to drag the cursor.		Tap twice (at the same speed as double-clicking a mouse button); rest your finger on the touchpad on the second tap and drag the cursor.	Drag
Access context menu		Click once.		Access context menu

NOTE: Illustrations are for reference only. The exact configuration of your PC depends on the model purchased.

NOTE: When using the touchpad, keep it — and your fingers — dry and clean. The touchpad is sensitive to finger movement; hence, the lighter the touch, the better the response. Tapping harder will not increase the touchpad's responsiveness.

NOTE: By default, vertical and horizontal scrolling is enabled on your touchpad. It can be disabled under Mouse settings in Windows Control Panel.

Using the Keyboard

The keyboard has full-sized keys and an embedded numeric keypad, separate cursor, lock, Windows, function and special keys.

Lock Keys and numeric keypad

The keyboard has three lock keys which you can toggle on and off.



















Lock key	Description
Caps Lock	When Caps Lock is on, all alphabetic characters typed are in uppercase.
Num Lock	When Num Lock is on, the numeric keypad is in numeric mode. The keys function as a calculator (complete with the arithmetic operators +, -, *, and /). Use this mode when you need to do a lot of numeric data entry. A better solution would be to connect an external keypad.
Scroll Lock <Fn> + <F12>	When Scroll Lock is on, the screen moves one line up or down when you press the up or down arrow keys respectively. Scroll Lock does not work with some applications.

The keyboard has a numeric keypad with cursor-control keys.

Desired access	Num Lock on	Num Lock off
Number keys on embedded keypad	Type numbers in a normal manner.	
Cursor-control keys on embedded keypad	Hold <Shift> while using cursor-control keys.	Hold <Fn> while using cursor-control keys.
Main keyboard keys	Hold <Fn> while typing letters on embedded keypad.	Type the letters in a normal manner.

Windows Keys

The keyboard has two keys that perform Windows-specific functions.

Key	Description
 Windows key	<p>Pressed alone, this key has the same effect as clicking on the Windows Start button; it launches the Start menu.</p> <p>It can also be used with other keys to provide a variety of functions:</p> <ul style="list-style-type: none"><  >: Open or close the Start menu<  > + <D>: Display the desktop<  > + <E>: Open Windows Explore<  > + <F>: Search for a file or folder<  > + <G>: Cycle through Sidebar gadgets<  > + <L>: Lock your computer (if you are connected to a network domain), or switch users (if you're not connected to a network domain)<  > + <M>: Minimizes all windows<  > + <R>: Open the Run dialog box<  > + <T>: Cycle through programs on the taskbar<  > + <U>: Open Ease of Access Center<  > + <X>: Open Windows Mobility Center<  > + <BREAK>: Display the System Properties dialog box<  > + <SHIFT+M>: Restore minimized windows to the desktop<  > + <TAB>: Cycle through programs on the taskbar by using Windows Flip 3-D<  > + <SPACEBAR>: Bring all gadgets to the front and select Windows Sidebar<CTRL> + <  > + <F>: Search for computers (if you are on a network)<CTRL> + <  > + <TAB>: Use the arrow keys to cycle through programs on the taskbar by using Windows Flip 3-D <p>Note: Depending on your edition of Windows Vista, some shortcuts may not function as described.</p>
 Application key	This key has the same effect as clicking the right mouse button; it opens the application's context menu.

Special Key (only for certain models)

You can locate the Euro symbol and the US dollar sign at the upper-center and/or bottom-right of your keyboard.

The Euro symbol

1. Open a text editor or word processor.
2. Either press < € > on the keyboard, or hold <Alt Gr> and then press the <5> key at the upper-center of the keyboard.

NOTE: Some fonts and software do not support the Euro symbol. Please refer to www.microsoft.com/typography/faq/faq12.htm for more information.

The US dollar sign

1. Open a text editor or word processor.

2. Either press < \$ > at the bottom-right of the keyboard, or hold < Shift > and then press the < F4 > key at the upper-center of the keyboard.

NOTE: This function varies according to the language settings.

Windows Mobility Center

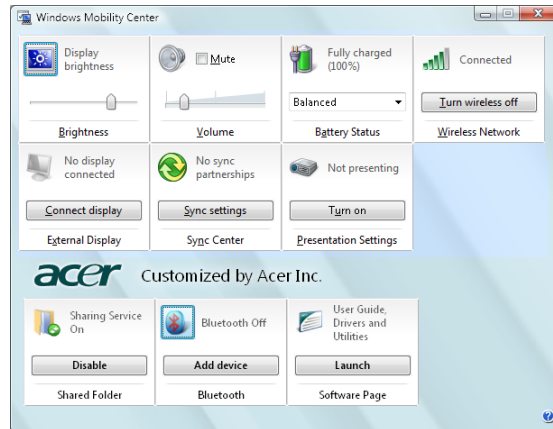

The Windows Mobility Center collects key mobile-related system settings in one easy-to-find place, so you can quickly configure your Acer system to fit the situation as you change locations, networks or activities. Settings include display brightness, volume, power plan, wireless networking on/off, external display settings, synchronization status and presentation settings.

Windows Mobility Center also includes Acer-specific settings like sharing folders overview/sharing service on or off, Bluetooth Add Device (if applicable), and a shortcut to the Acer user guide, drivers and utilities.

To launch Windows Mobility Center:

- q Use the shortcut key < Win > + < X >.
- q Start Windows Mobility Center from the Control panel.
- q Start Windows Mobility Center from the Accessories program group in the Start menu.
- q Launch Windows Mobility Center by right-clicking  in the system tray and select **Windows Mobility Center**.

Using the System Utilities

Acer GridVista (dual-display compatible)

NOTE: This feature is only available on certain models.

To enable the dual monitor feature of the notebook, first ensure that the second monitor is connected, then select **Start, Control Panel, Display** and click on **Settings**. Select the secondary monitor (**2**) icon in the display box and then click the check box **Extend my windows desktop onto this monitor**. Finally, click **Apply** to confirm the new settings and click **OK** to complete the process.

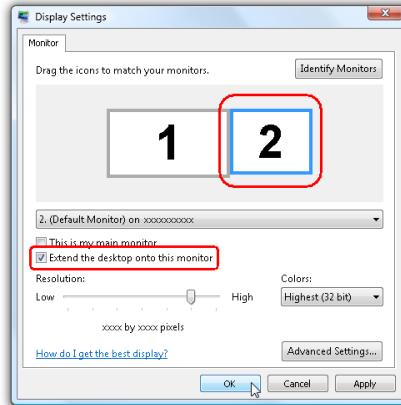

Acer GridVista is a handy utility that offers four pre-defined display settings so you can view multiple windows on the same screen. To access this function, please go to **Start>All Programs** and click on **Acer GridVista**. You may choose any one of the four display settings indicated below:

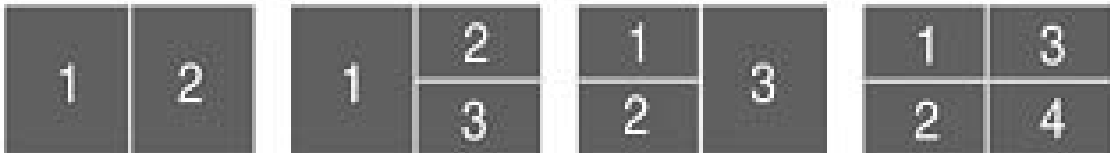

Double (vertical), Triple (primary at left), Triple (primary at right), or Quad Acer GridVista is dual-display compatible, allowing two displays to be partitioned independently.

Acer GridVista is dual-display compatible, allowing two displays to be partitioned independently.

AcerGridVista is simple to set up:

1. Run Acer GridVista and select your preferred screen configuration for each display from the task bar.
2. Drag and drop each window into the appropriate grid.
3. Enjoy the convenience of a well-organized desktop.

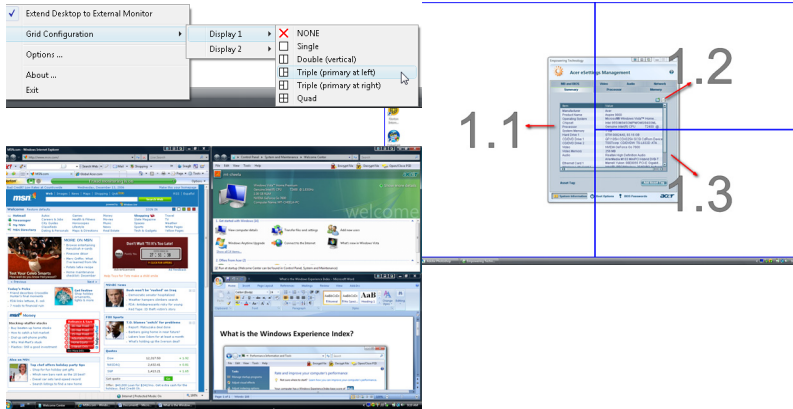

NOTE: Please ensure that the resolution setting of the second monitor is set to the manufacturer's recommended value.

Hardware Specifications and Configurations

Processor

Item	Specification
CPU type	Aspire 7740: Intel® Core i5 540M 2.53G 3M Aspire 7740G: Intel® Core i3 330M PGA 2.13G 3M Intel® Core i7 620M 2.66G 4M Intel® Core i7 720QM 1.6G 6M
Core logic	PCH/HM55 Express chipset
CPU package	PGA 988

CPU Fan True Value Table

DTS(degree C)	Fan Speed (rpm)	Acoustic Level (dBA)
45-50	0-3000	29
55-66	0-3300	33
68-74	3300-3800	38
78-83	3800-4100	40
86-91	4100-4800	40

Throttling 50%: On= 99 ° C; OFF=93 ° C

OS shut down at 105 ° C; H/W shot down at 110 ° .C

BIOS

Item	Specification
BIOS vendor	Phoenix
BIOS Version	1.06
Supported protocol	ACPI 1.0b/2.0/3.0 compliance, PCI 2.2, System/HDD Password Security Control, INT 13H Extension, PnP BIOS 1.0a SMBIOS 2.4, BIOS Boot Specification, Simple Boot Flag 1.0, Boot Block, PCI Bus Power Management Interface Specification, USB Specification 1.1/2.0, IEEE 1394 1.0, USB/1394 CD-ROM Boot Up support, PC Card Standard 1995 (PCMCIA 3.0 Compliant Device), IrDA 1.0, Intel AC97 CNR Specification, WfM 2.0, PXE 2.1, Boot Integrity Service Application Program Interface (BIS) 1.0, PC99a and Mobile PC2001 Compliant

System Memory

Item	Specification
Memory controller	Built-in
Memory size	0MB (no on-board memory)
DIMM socket number	2 sockets
Supports memory size per socket	2048MB
Supports maximum memory size	4G for 64bit OS (with two 2GB SODIMM)
Supports DIMM type	DDR 3 synchronous DRAM
Supports DIMM Speed	1066/1333 MHz
Supports DIMM voltage	1.5V
Supports DIMM package	240-pin soDIMM

System Memory

Item	Specification
Memory module combinations	You can install memory modules in any combinations as long as they match the above specifications.

Memory Combinations

Slot 1	Slot 2	Total Memory
0MB	1024MB	1024MB
0MB	2048MB	2048MB
1024MB	0MB	1024MB
1024MB	1024MB	2048MB
1024MB	2048MB	3072MB
2048MB	0MB	2048MB
2048MB	1024MB	3072MB
2048MB	2048MB	4096MB

NOTE: Above table lists some system memory configurations. You may combine DIMMs with various capacities to form other combinations. On above table, the configuration of slot 1 and slot 2 could be reversed.

LAN Module

Item	Specification
LAN Chipset	Broadcom BCM 57780
Supports LAN protocol	10/100/1000 Mbps
LAN connector type	RJ45
LAN connector location	Left side
Features	Integrated 10/100 BASE-T transceiver Wake on LAN support compliant with ACPI 2.0 PCI v2.2

Bluetooth Interface

Item	Specification
Chipset	Foxconn Bluetooth BRM 2046 BT2.1 (T60H928.33) f/w:861
Data throughput	723 bps (full speed data rate)
Protocol	Bluetooth 2.1
Interface	USB 1.1
Connector type	USB

Wireless Module 802.11b/g/n

Item	Specification
Chipset	LAN Intel WLAN INT1000HBG; QMI Wireless LAN Atheros HB93 1x2 BGN (HM) EM306
Data throughput	11~54 Mbps, up to 270 Mbps for Draft-N
Protocol	802.11 b/g/n
Interface	PCI Express ® mini-card rev. 1.2

Hard Disk Drive

Item					
Vendor & Model Name	HGST 2.5" HTS543216L9A3 00 Seagate 2.5" ST9160310AS Toshiba 2.5" Mk1655GSX WD 2.5" WD1600BEVT- 22ZCT0	HGST 2.5" HTS545025B9A3 00 Seagate 2.5" ST9250315AS Toshiba 2.5" Mk2555GSX WD 2.5" WD2500BEVT- 22ZCT0	Seagate 2.5" ST9320320AS Toshiba 2.5" Mk3255GSX HGST 2.5" HTS545032B9A3 00 WD 2.5" WD3200BEVT- 22ZCT0	HGST 2.5" HTS545050B9A 300 Seagate 2.5" ST9500325AS Toshiba 2.5" Mk5055GSX WD 2.5" WD5000BEVT- 22ZAT0	WD 2.5" WD6400BEVT- 22A0RTO
Capacity (MB)	160000	250000	320000	500000	640000
Bytes per sector	512	512	512	512	512
Data heads	3/4	2	3	4	2/4
Drive Format					
Disks	2	2	2	2	NA
Spindle speed (RPM)	5400 RPM	5400 RPM	5400 RPM	5400 RPM	7200 RPM
Performance Specifications					
Buffer size	8MB	8MB	8MB	8MB	16MB
Interface	SATA	SATA	SATA	SATA	SATA
Max. media transfer rate (disk-buffer, Mbytes/s)	540	875 (Max. 3.0 Gbit/s Buffer-host data transfer)	875 (Max. 3.0 Gbit/s Buffer-host data transfer)	875 (Max. 3.0 Gbit/s Buffer-host data transfer)	Max. 3.0 Gbit/s Buffer-host data transfer
DC Power Requirements					
Voltage tolerance	5V(DC) +/- 5%	5V(DC) +/- 5%	5V(DC) +/- 5%	5V(DC) +/- 5%	5V(DC) +/- 5%

Optical Disc Drive

Item	Specification	
Vendor & model name	W/O BEZEL SATA FOR HF+WINDOWS7 1. HLDS SUPER-MULTI DRIVE DL 8X GT30N LF 2. PLDS SUPER-MULTI DRIVE DL 8X DS-8A4SH LF 3. SONY SUPER-MULTI DRIVE DL 8X AD-7585H LF 4. TOSHIBA SUPER-MULTI DRIVE DL 8X TS-L633C LF	
Performance Specification	With CD Diskette	With DVD Diskette
Transfer rate (KB/sec)	Sustained: Max 3.6Mbytes/sec	Sustained: Max 10.08Mbytes/sec
Buffer Memory	2MB	
Interface	SATA	

Optical Disc Drive

Item	Specification
Applicable disc format	Applicable disc format CD: CD-DA, CD-ROM, CD-ROM XA, Photo CD (multi-session), Video CD, Cd-Extra (CD+), CD-text DVD: DVD-VIDEO, DVD-ROM, DVD-R (3.9GB, 4.7GB) DVD-R DL, DVD-RW, DVD-RAM, DVD+R, DVD+R DL, DVD+RW CD: CD-DA (Red Book) - Standard Audio CD & CD-TEXT CD-ROM (Yellow Book Mode1 & 2) - Standard Data CD-ROM XA (Mode2 Form1 & 2) - Photo CD, Multi-Session CD-I (Green Book, Mode2 Form1 & 2, Ready, Bridge) CD-Extra/ CD-Plus (Blue Book) - Audio & Text/Video Video-CD (White Book) - MPEG1 Video CD-R (Orange Book Part) CD-RW & HSRW (Orange Book Part Volume1 & Volume 2 Super Audio CD (SACD) Hybrid type US & US+ RW DVD: DVD-ROM (Book 1.02), DVD-Dual DVD-Video (Book 1.1) DVD-R (Book 1.0, 3.9G) DVD-R (Book 2.0, 4.7G) - General & Authoring DVD+R (Version 1.0) DVD+RW DVD-RW (Non CPRM & CPRM) DVD ^o R Dual
Loading mechanism	Load: Manual Release: (a) Electrical Release (Release Button) (b) Release by ATAPI command (c) Emergency Release
Power Requirement	
Input Voltage	5 V +/- 5% (Operating)

Blu-Ray Disc Drive

Item	Specification		
Vendor & model name	W/O BEZEL FOR WINDOWS7 1. PIONEER BD COMBO 12.7MM TRAY DL 4X SATA BDC-TD01RS LF 2. SONY BD COMBO 12.7MM TRAY DL 4X BC-5500S LF 3. PLDS BD COMBO 12.7MM TRAY DL 4X DS-4E1S LF		
Performance Specification	With CD Disc	With DVD Disc	With Blu-ray Disc
Transfer rate (KB/sec)	Sustained: Max 3.6Mbytes/sec	Sustained: Max 10.08Mbytes/sec	Sustained: Max 11 Mbytes/sec
Buffer Memory	2MB		4.5 MB
Interface	SATA		

Blu-Ray Disc Drive

Item	Specification
Applicable disc format	<p>Applicable disc format</p> <p>CD: CD-DA, CD-ROM, CD-ROM XA, Photo CD (multi-session), Video CD, Cd-Extra (CD+), CD-text</p> <p>DVD: DVD-VIDEO, DVD-ROM, DVD-R (3.9GB, 4.7GB) DVD-R DL, DVD-RW, DVD-RAM, DVD+R, DVD+R DL, DVD+RW</p> <p>CD:</p> <p>CD-DA (Red Book) - Standard Audio CD & CD-TEXT</p> <p>CD-ROM (Yellow Book Mode1 & 2) - Standard Data</p> <p>CD-ROM XA (Mode2 Form1 & 2) - Photo CD, Multi-Session</p> <p>CD-I (Green Book, Mode2 Form1 & 2, Ready, Bridge)</p> <p>CD-Extra/ CD-Plus (Blue Book) - Audio & Text/Video</p> <p>Video-CD (White Book) - MPEG1 Video</p> <p>CD-R (Orange Book Part)</p> <p>CD-RW & HSRW (Orange Book Part Volume1 & Volume 2)</p> <p>Super Audio CD (SACD) Hybrid type</p> <p>US & US+ RW</p> <p>DVD:</p> <p>DVD-ROM (Book 1.02), DVD-Dual</p> <p>DVD-Video (Book 1.1)</p> <p>DVD-R (Book 1.0, 3.9G)</p> <p>DVD-R (Book 2.0, 4.7G) - General & Authoring</p> <p>DVD+R (Version 1.0)</p> <p>DVD+RW</p> <p>DVD-RW (Non CPRM & CPRM)</p> <p>DVD+/-R Dual</p> <p>Blu-Ray:</p> <p>BD-R, BD-R DL, BD-RE, BD-RE DL</p>
Loading mechanism	<p>Load: Manual</p> <p>Release: (a) Electrical Release (Release Button)</p> <p>(b) Release by ATAPI command</p> <p>(c) Emergency Release</p>
Power Requirement	
Input Voltage	5 V +/- 5% (Operating)

Audio Interface

Item	Specification
Audio Controller	Realtek ALC669X
Audio onboard or optional	Built-in
Mono or Stereo	Stereo
Resolution	18 bit stereo full duplex
Compatibility	HD audio Interface; S/PDIF output for PCM or AC-3 content
Sampling rate	1Hz resolution VSR (Variable Sampling Rate)
Internal microphone	Yes
Internal speaker / Quantity	Yes/2.1 (2W speakers)

Video Memory

Item	Specification
Chipset	UMA AMD PARK_XT 40nm 29mm*29mm M2 package AMD MADISON_PRO 40nm 29mm*29mm M2 package
Memory size	1 GB DDR3

System Board Major Chips

Item	Controller
PCH	IC PCH HM55 QMNT MM#904529 B3
MODEM	Foxconn Delphi-AM5 V2H 1.5_3.3V AUS T60M951.36
Bluetooth	Foxconn Bluetooth BRM 2046 BT2.1
Wireless 802.11 b/g/n	LAN Intel WLAN INT1000HBG; QMI Wireless LAN Atheros HB93 1x2 BGN (HM) EM306
5 in 1 Card Reader	AU6433
Audio Codec	Realtek ALC669X

Keyboard

Item	Specification
Keyboard controller	NPCE781B
Total number of keypads	103-/104-/107-key keyboard
Windows logo key	Yes
Internal & external keyboard work simultaneously	Plug USB keyboard to the USB port directly: Yes

Battery

Item	Specification
Vendor	SONY/SANYO/PANASONIC/SIMPLO
Battery Type	Li-ion
Pack capacity	4400/4800mAh
Number of battery cell	6/8
Package configuration	3/4 cells in series, 2 series in parallel

LCD 17.3" inch

Item	Specification
Vendor & model name	AUO/CMO/LPL/Samsung
Screen Diagonal (mm)	17.3 inches
Display resolution (pixels)	17.3" WXGA+ Glare
Pixel Pitch	0.204 x 0.204
Pixel Arrangement	R.G.B. Vertical Stripe
Display Mode	Normally White
Typical White Luminance (NIT) also called Brightness	220

LCD 17.3" inch

Item	Specification
Luminance Uniformity	1.25 max.
Contrast Ratio	400 typical
Response Time msec	8
Nominal Input Voltage VDD	+3.3V
Viewing Angle (degree) Horizontal: Right/Left Vertical: Upper/Lower	45/45 15/35
Temperature Range(° C) Operating Storage (shipping)	0 to +50 -40 to +60

AC Adaptor

Item	Specification
Vendor	DELTA, LITEON, HIPRO
Input	100-240V~ 1.5A, 50-60Hz/
Output	19V, 65W/90W, 2-pin

System Power Management

ACPI mode	Power Management
Mech. Off (G3)	All devices in the system are turned off completely.
Soft Off (G2/S5)	OS initiated shutdown. All devices in the system are turned off completely.
Working (G0/S0)	Individual devices such as the CPU and hard disc may be power managed in this state.
Suspend to RAM (S3)	CPU set power down VGA Suspend PCMCIA Suspend Audio Power Down Hard Disk Power Down CD-ROM Power Down Super I/O Low Power mode
Save to Disk (S4)	Also called Hibernation Mode. System saves all system states and data onto the disc prior to power off the whole system.

System Utilities

BIOS Setup Utility

The BIOS Setup Utility is a hardware configuration program built into your computer's BIOS (Basic Input/Output System).

Your computer is already properly configured and optimized, and you do not need to run this utility. However, if you encounter configuration problems, you may need to run Setup. Please also refer to Chapter 4 Troubleshooting when problem arises.

To activate the BIOS Utility, press **F2** during POST (when "Press <F2> to enter Setup" message is prompted on the bottom of screen).

Press **F2** to enter setup. The default parameter of F12 Boot Menu is set to "disabled". If you want to change boot device without entering BIOS Setup Utility, please set the parameter to "enabled".

Press <F12> during POST to enter multi-boot menu. In this menu, user can change boot device without entering BIOS SETUP Utility.

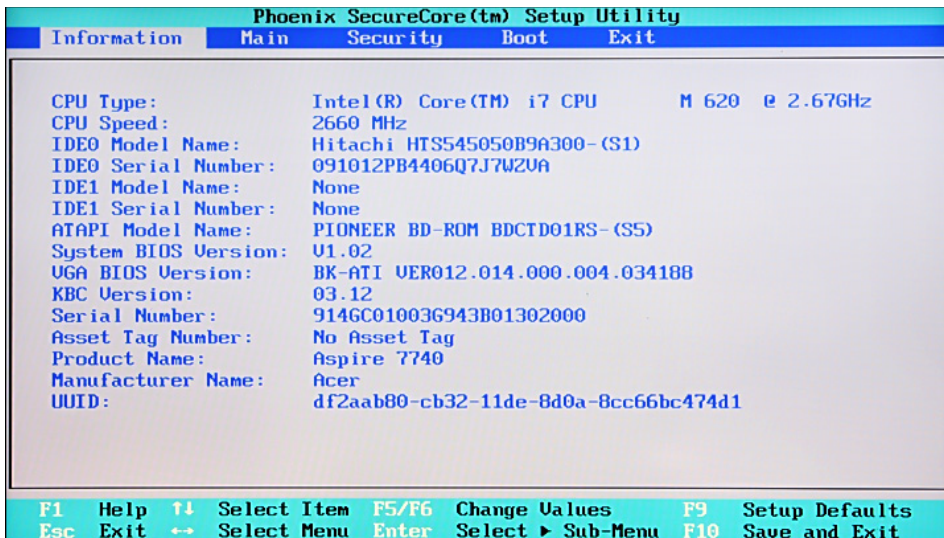

Navigating the BIOS Utility

There are five menu options: Information, Main, Security, Boot, and Exit.

Follow these instructions:

- To choose a menu, use the left and right arrow keys.
- To choose an item, use the up and down arrow keys.
- To change the value of a parameter, press **F5** or **F6**.
- A plus sign (+) indicates the item has sub-items. Press **Enter** to expand this item.
- Press **Esc** while you are in any of the menu options to go to the Exit menu.
- In any menu, you can load default settings by pressing **F9**. You can also press **F10** to save any changes made and exit the BIOS Setup Utility.

NOTE: You can change the value of a parameter if it is enclosed in square brackets. Navigation keys for a particular menu are shown on the bottom of the screen. Help for parameters are found in the Item Specific Help part of the screen. Read this carefully when making changes to parameter values. **Please note that system information is subject to different models.**

Information

The Information screen displays a summary of your computer hardware information.

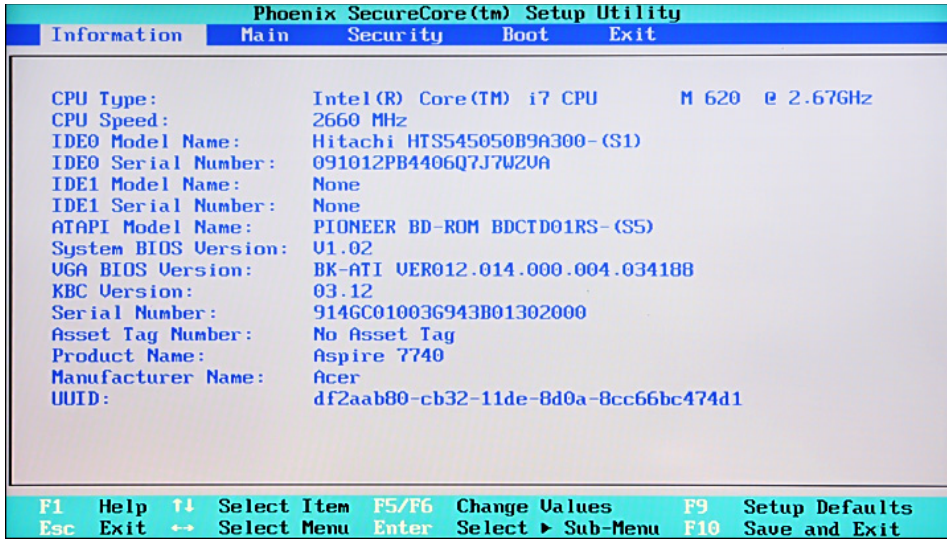

NOTE: The system information is subject to different models.

Parameter	Description
CPU Type	This field shows the CPU type and speed of the system.
CPU Speed	This field shows the speed of the CPU.
IDE0 Model Name	This field shows the model name of HDD installed on primary IDE master.
IDE0 Serial Number	This field displays the serial number of HDD installed on primary IDE master.
IDE1 Model Name	This field shows the model name of HDD installed on secondary IDE master.
IDE1 Serial Number	This field displays the serial number of HDD installed on secondary IDE master.
ATAPI Model Name	This field shows the model name of the Optical device installed in the system.
System BIOS Version	Displays system BIOS version.
VGA BIOS Version	This field displays the VGA firmware version of the system.
KBC Variation	This field shows the keyboard
Serial Number	This field displays the serial number of this unit.
Asset Tag Number	This field displays the asset tag number of the system.
Product Name	This field shows product name of the system.
Manufacturer Name	This field displays the manufacturer of this system.
UUID Number	Universally Unique Identifier (UUID) is an identifier standard used in software construction, standardized by the Open Software Foundation (OSF) as part of the Distributed Computing Environment (DCE).

Main

The Main screen allows the user to set the system time and date as well as enable and disable boot option and recovery.

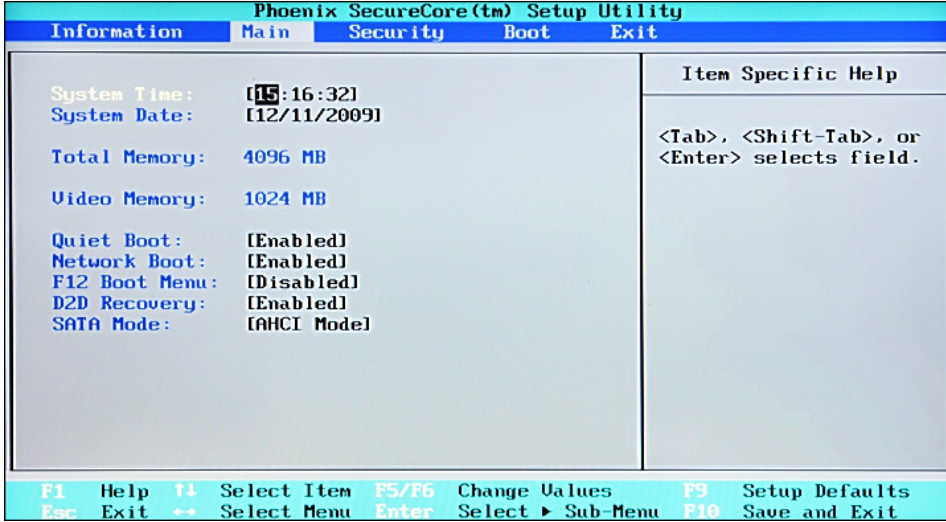

NOTE: The screen above is for your reference only. Actual values may differ.

The table below describes the parameters in this screen. Settings in **boldface** are the default and suggested parameter settings.

Parameter	Description	Format/Option
System Time	Sets the system time. The hours are displayed with 24-hour format.	Format: HH:MM:SS (hour:minute:second) System Time
System Date	Sets the system date.	Format MM/DD/YYYY (month/day/year) System Date
Total Memory	This field reports the total memory size of the system.	
Video Memory	Shows the VGA memory size.	
Quiet Boot	Determines if Customer Logo will be displayed or not; shows Summary Screen is disabled or enabled. Enabled: Customer Logo is displayed, and Summary Screen is disabled. Disabled: Customer Logo is not displayed, and Summary Screen is enabled.	Option: Enabled or Disabled
Network Boot	Enables, disables the system boot from LAN (remote server).	Option: Enabled or Disabled
F12 Boot Menu	Enables, disables Boot Menu during POST.	Option: Disabled or Enabled
D2D Recovery	Enables, disables D2D Recovery function. The function allows the user to create a hidden partition on hard disc drive to store operation system and restore the system to factory defaults.	Option: Enabled or Disabled
SATA Mode	Control the mode in which the SATA controller should operate.	Option: AHCI or IDE

NOTE: The sub-items under each device will not be shown if the device control is set to disable or auto. This is because the user is not allowed to control the settings in these cases.

Security

The Security screen contains parameters that help safeguard and protect your computer from unauthorized use.

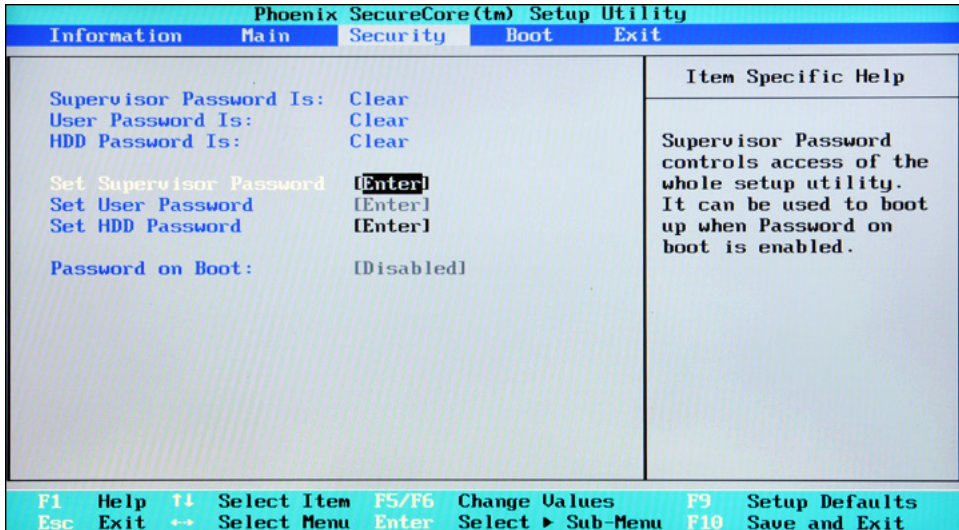

NOTE: Please refer to “Remove HDD/BIOS Password” section if you need to know how to remove HDD/BIOS Password.

The table below describes the parameters in this screen. Settings in **boldface** are the default and suggested parameter settings.

Parameter	Description	Option
Supervisor Password Is	Shows the setting of the Supervisor password	Clear or Set
User Password Is	Shows the setting of the user password.	Clear or Set
HDD Password Is	Shows the setting of the hard disk password.	Clear or Set
Set Supervisor Password	Press Enter to set the supervisor password. When set, this password protects the BIOS Setup Utility from unauthorized access. The user can not either enter the Setup menu nor change the value of parameters.	
Set User Password	Press Enter to set the user password. When user password is set, this password protects the BIOS Setup Utility from unauthorized access. The user can enter Setup menu only and does not have right to change the value of parameters.	
Set HDD Password	Enter HDD Password.	
Password on Boot	Defines whether a password is required or not while the events defined in this group happened. The following sub-options are all requires the Supervisor password for changes and should be grayed out if the user password was used to enter setup.	Disabled or Enabled

NOTE: When you are prompted to enter a password, you have three tries before the system halts. Don't forget your password. If you forget your password, you may have to return your notebook computer to your dealer to reset it.

Setting a Password

Follow these steps as you set the user or the supervisor password:

1. Use the up/down keys to highlight the Set Supervisor Password parameter and press the Enter key. The Set Supervisor Password box appears:

Set Supervisor Password		
Enter New Password	[]
Confirm New Password	[]

2. Type a password in the “Enter New Password” field. The password length can not exceeds 8 alphanumeric characters (A-Z, a-z, 0-9, not case sensitive). Retype the password in the “Confirm New Password” field.

IMPORTANT: Be very careful when typing your password because the characters do not appear on the screen.

3. Press Enter.
After setting the password, the computer sets the User Password parameter to “Set”.
4. If desired, you can opt to enable the Password on boot parameter.
5. When you are done, press F10 to save the changes and exit the BIOS Setup Utility.

Removing a Password

Follow these steps:

1. Use the up/down keys to highlight the Set Supervisor Password parameter and press the Enter key. The Set Password box appears:

Set Supervisor Password		
Enter current password	[]
Enter New Password	[]
Confirm New Password	[]

2. Type the current password in the Enter Current Password field and press Enter.
3. Press Enter twice **without** typing anything in the Enter New Password and Confirm New Password fields. The computer then sets the Supervisor Password parameter to “Clear”.
4. When you have changed the settings, press F10 to save the changes and exit the BIOS Setup Utility.

Changing a Password

1. Use the up/down keys to highlight the Set Supervisor Password parameter and press the Enter key. The Set Password box appears:

Set Supervisor Password		
Enter current password	[]
Enter New Password	[]
Confirm New Password	[]

2. Type the current password in the Enter Current Password field and press Enter.
3. Type a password in the Enter New Password field. Retype the password in the Confirm New Password field.
4. Press Enter. After setting the password, the computer sets the User Password parameter to "Set".
5. If desired, you can enable the Password on boot parameter.
6. When you are done, press F10 to save the changes and exit the BIOS Setup Utility.

If the verification is OK, the screen will display as following.

Setup Notice
Changes have been saved.
[continue]

The password setting is complete after the user presses Enter.

If the current password entered does not match the actual current password, the screen will show you the Setup Warning.

Setup Warning
Invalid password
Re-enter Password
[continue]

If the new password and confirm new password strings do not match, the screen will display the following message.

Setup Warning
Password do not match
Re-enter Password

Boot

This menu allows the user to decide the order of boot devices to load the operating system. Bootable devices includes the diskette drive in module bay, the onboard hard disk drive and the CD-ROM in module bay.

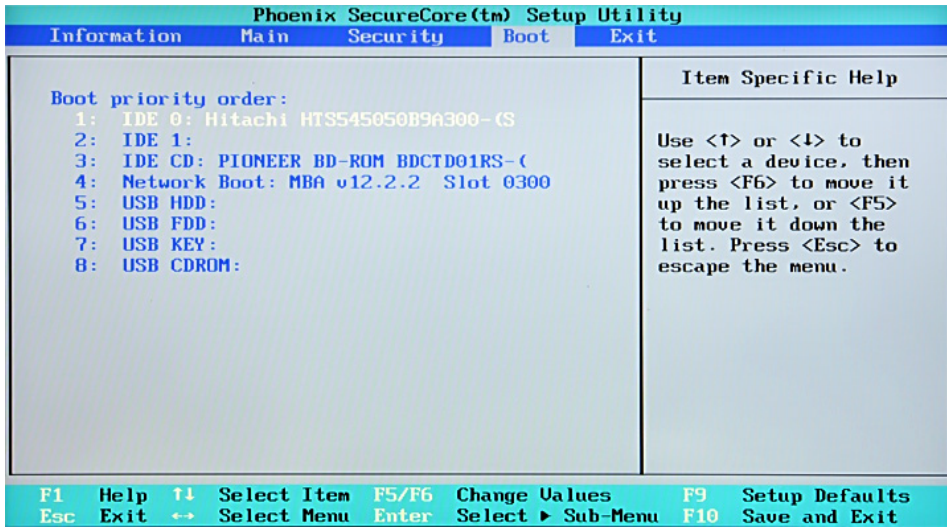

Exit

The Exit screen contains parameters that confirmed or discard the changes made to the parameters in the BIOS Setup Utility.

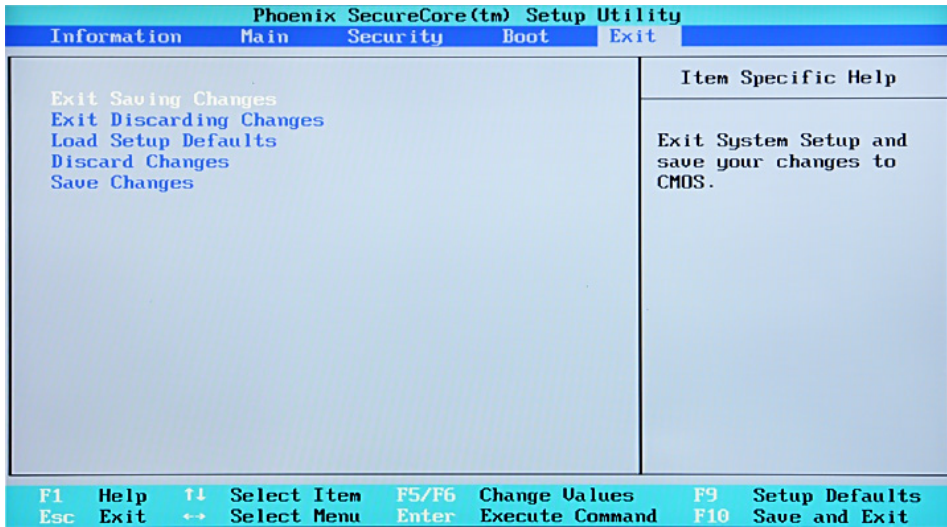

The table below describes the parameters in this screen.

Parameter	Description
Exit Saving Changes	Exit System Setup and save your changes to CMOS.
Exit Discarding Changes	Exit utility without saving setup data to CMOS.
Load Setup Default	Load default values for all SETUP item.
Discard Changes	Load previous values from CMOS for all SETUP items.
Save Changes	Save Setup Data to CMOS.

BIOS Flash Utility

The BIOS flash memory update is required for the following conditions:

- New versions of system programs
- New features or options
- Restore a BIOS when it becomes corrupted.

Use the Flash utility to update the system BIOS flash ROM.

NOTE: If you do not have a crisis recovery disk at hand, then you should create a **Crisis Disk** (See “Steps for BIOS Recovery by Crisis Disk” on page 108) before you use the Flash utility.

NOTE: Do not install memory-related drivers (XMS, EMS, DPMS) when you use the Flash.

NOTE: Please connect the AC adapter power supply when you run the Flash utility. If the battery pack does not contain enough power to finish BIOS flash, you may not boot the system because the BIOS is not completely loaded.

Follow the steps below to run the Flash utility:

1. Rename the BIOS file as “XXXXXXX.FD”
2. Copy the “XXXXXXX.FD” file to a bootable USB device containing the Crisis Disk.
3. Turn off the system power.
4. Insert the USB device containing the renamed BIOS file and Crisis Disk to any USB port.
5. Make sure the AC adapter is connected to a power outlet and plugged in to the system.
6. Power on the system from an off state (i.e. cold boot) while holding down the Fn + ESC key.
7. After POST, release Fn + ESC key. The system should boot from the USB device and perform crisis recovery action.

Remove HDD Password

This section teaches you how to remove HDD password:

Remove HDD Password:

- If you key in the wrong HDD password thrice, “HDD password error code” will appear on the screen. See the image below.

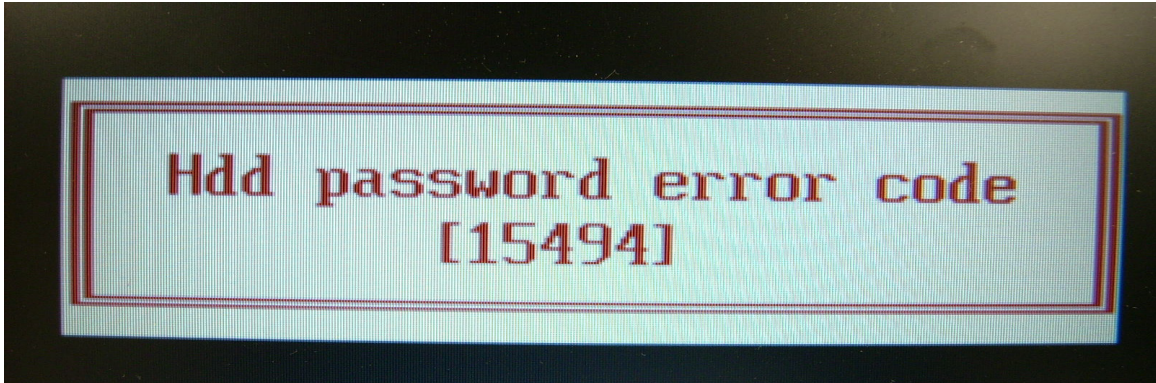

- If you need to solve HDD password locked problem, you can run HDD_PW.EXE
 1. Key in “hdd_pw 15494 0”
 2. Select “2”
 3. Choose one of the uppercase strings

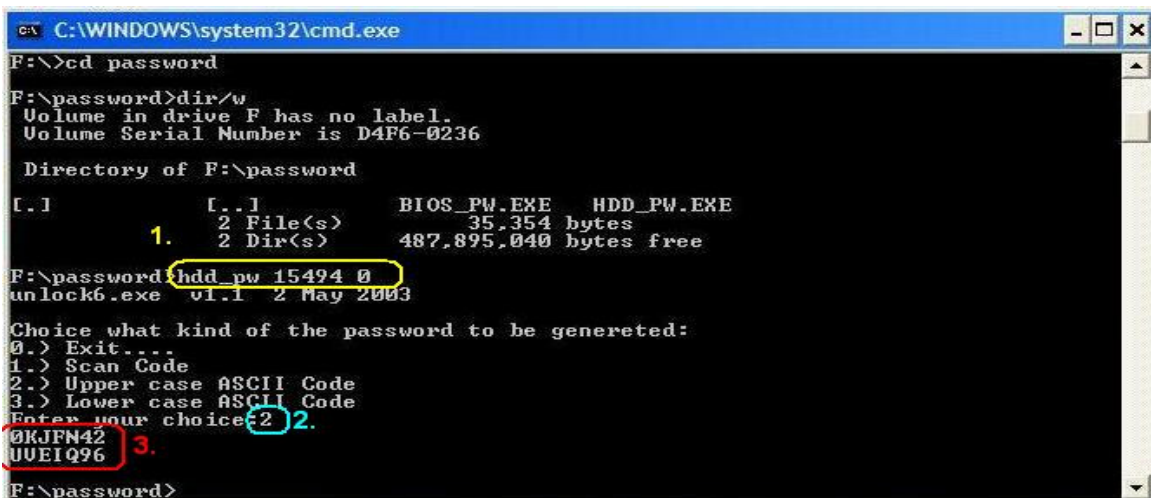

- Reboot the system and key in “0KJFN42” or “UVEIQ96” as your HDD user password.



Machine Disassembly and Replacement

This chapter contains step-by-step procedures on how to disassemble the notebook computer for maintenance and troubleshooting.

Disassembly Requirements

To disassemble the computer, you need the following tools:

- Wrist grounding strap and conductive mat for preventing electrostatic discharge
- Flat screwdriver
- Philips screwdriver
- Hex screwdriver
- Plastic flat screwdriver
- Plastic tweezers

NOTE: The screws for the different components vary in size. During the disassembly process, group the screws with the corresponding components to avoid mismatch when putting back the components.

General Information

Pre-disassembly Instructions

Before proceeding with the disassembly procedure, make sure that you do the following:

1. Turn off the power to the system and all peripherals.
2. Unplug the AC adapter and all power and signal cables from the system.



3. Place the system on a flat, stable surface.
4. Remove the SD dummy card in the card reader card slot.

Disassembly Process

The disassembly process is divided into the following stages:

- External module disassembly
- Main unit disassembly
- LCD module disassembly

The flowcharts provided in the succeeding disassembly sections illustrate the entire disassembly sequence. Observe the order of the sequence to avoid damage to any of the hardware components. For example, if you want to remove the main board, you must first remove the keyboard, then disassemble the inside assembly frame in that order.

Main Screw List

Item	Screw	Color	Part No.
A	M2.5 x L6	Black	86.00E12.536
B	M2.5 x L10	Black	86.00F84.73A
C	M2.5 x L4	Black	86.00H59.734
D	M2.5 x L3.5	Silver	86.9A563.3R5
E	M2.5 x L5	Black	86.00F87.735
F	M2 x L4	Silver	86.9A552.4R0
G	M2 x L3	Silver	86.9A522.3R0
H	M3 x L4	Silver	86.9A554.4R0

External Module Disassembly Process

External Modules Disassembly Flowchart

The flowchart below gives you a graphic representation on the entire disassembly sequence and instructs you on the components that need to be removed during servicing. For example, if you want to remove the main board, you must first remove the keyboard, then disassemble the inside assembly frame in that order.

EXTERNAL MODULE DISASSEMBLY

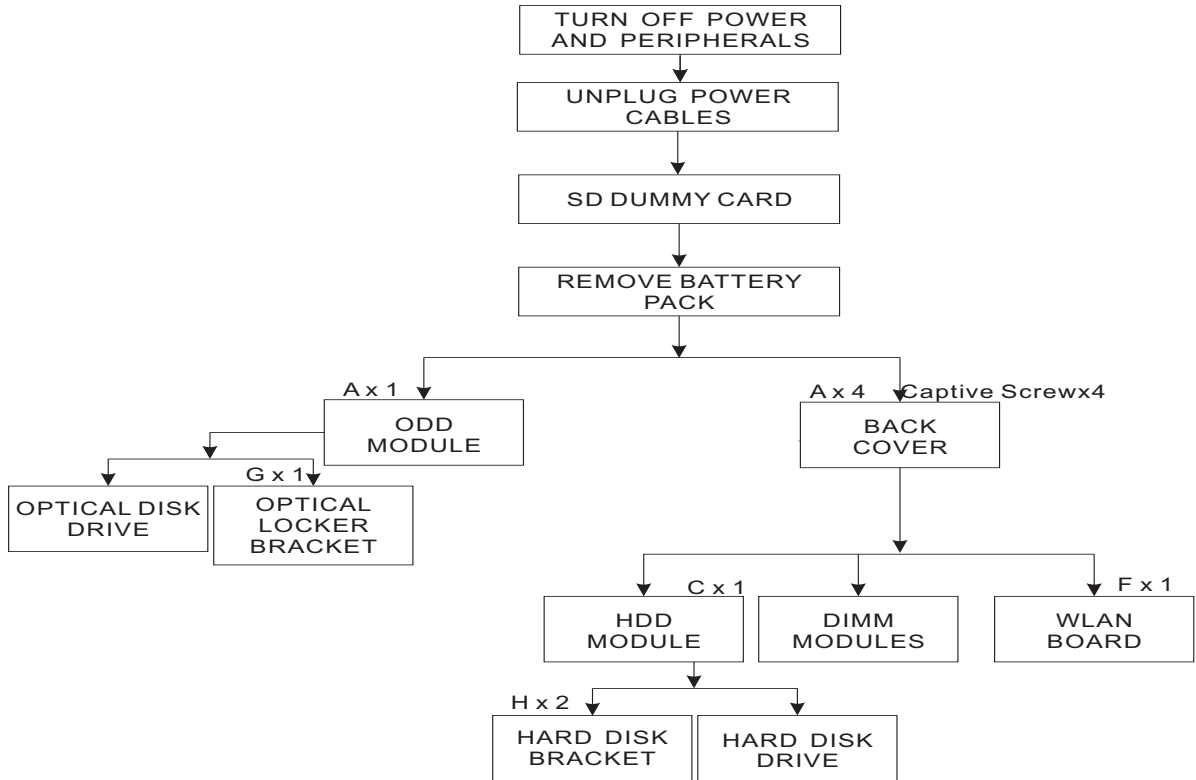

Item	Screw	Color	Part No.
A	M2.5 x L6	Black	86.00E12.536
C	M2.5 x L4	Black	86.00H59.734
F	M2 x L4	Silver	86.9A552.4R0
G	M2 x L3	Silver	86.9A522.3R0
H	M3 x L4	Silver	86.9A554.4R0

Removing the Battery Pack

1. Turn base unit over.
2. Slide the battery lock/unlock latch to the unlock position.



3. Slide the battery release latch to the release position (1) to pop out the battery pack, then remove the battery pack from the main unit (2).



Note: Battery has been highlighted with the yellow circle as above image shows. Please detach the battery and follow local regulations for disposal.

Removing the Optical Drive Module

1. See “Removing the Battery Pack” on page 40.
2. Remove the one screw (A) securing the optical drive module to the system.

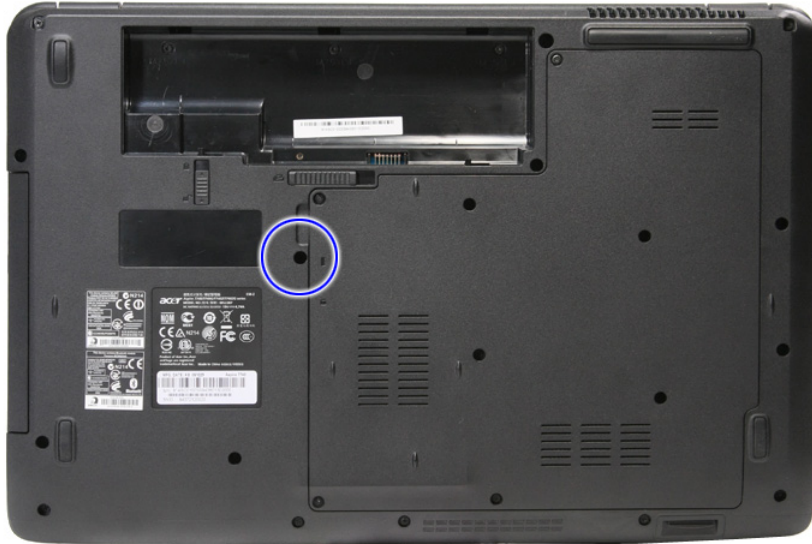

Size (Quantity)	Color	Torque	Part No.
M2.5 x L6 (1)	Black	3.0 kgf-cm	86.00E12.536

3. Slowly pull out the ODD module from the ODD drive bay.



4. Remove the one screw (G) securing the locker bracket and remove the locker bracket from the optical disk drive module.



Size (Quantity)	Color	Torque	Part No.
M2 x L3 (1)	Silver	1.6 kgf-cm	86.9A522.3R0

Removing the Back Cover

1. See “Removing the Battery Pack” on page 40.
2. Release the four screws (A) and four captive screws securing the back cover.



Size (Quantity)	Color	Torque	Part No.
M2.5 x L6 (4)	Black	3.0 kgf-cm	86.00E12.536

3. Pry loose and carefully lift and remove the back cover.



Removing the Hard Disk Drive Module

1. See “Removing the Battery Pack” on page 40.
2. See “Removing the Back Cover” on page 42.
3. Remove the one screw (C) securing the hard disk drive module to the system.



Size (Quantity)	Color	Torque	Part No.
M2.5 x L4 (1)	Black	3.0 kgf-cm	86.00H59.734

4. Lift the tab and slide the module away from the connector and remove it from the hard disk drive bay.



NOTE: To prevent damage to device, avoid pressing down on it or placing heavy objects on top of it.

5. Remove the two screws (H) securing the hard disk to the bracket and remove the hard disk from the bracket.

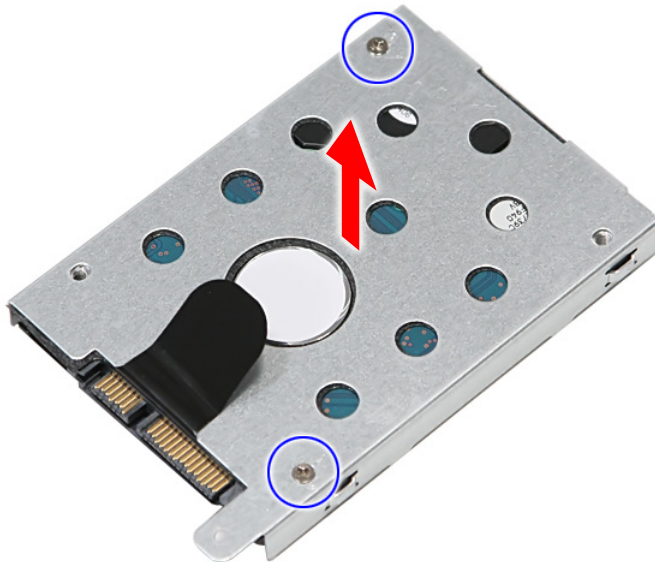

Size (Quantity)	Color	Torque	Part No.
M3 x L4 (2)	Silver	3.0 kgf-cm	86.9A554.4R0

Removing the Wireless LAN Card

1. See “Removing the Battery Pack” on page 40.
2. See “Removing the Back Cover” on page 42.

3. Detach the black cable from connector 1 and the white cable from connector 2 on the WLAN card.

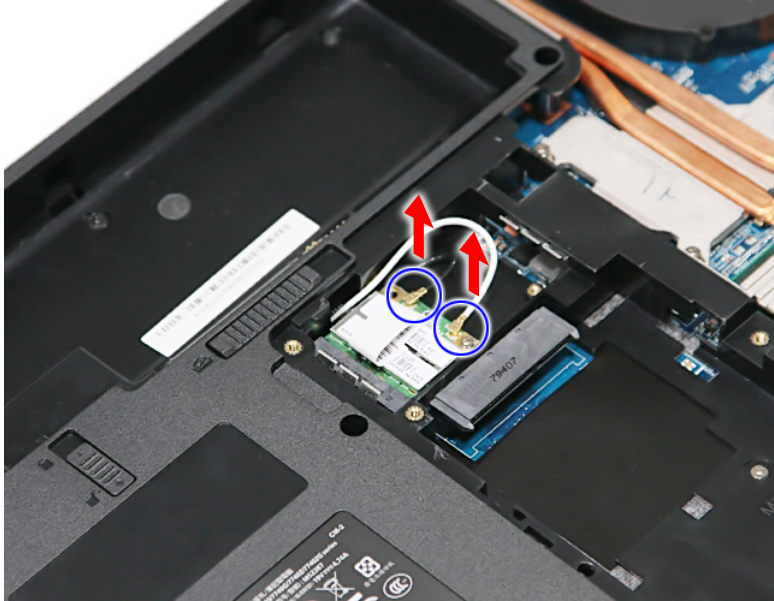

4. Remove the one screw (F) on the WLAN card and detach the card.



Size (Quantity)	Color	Torque	Part No.
M2 x L4 (1)	Silver	1.6 kgf-cm	86.9A552.4R0

5. Remove the wireless LAN card.



Removing the DIMM Module

1. See “Removing the Battery Pack” on page 40.
2. See “Removing the Back Cover” on page 42.
3. Push out the latches on both sides of the DIMM socket to release the DIMM.

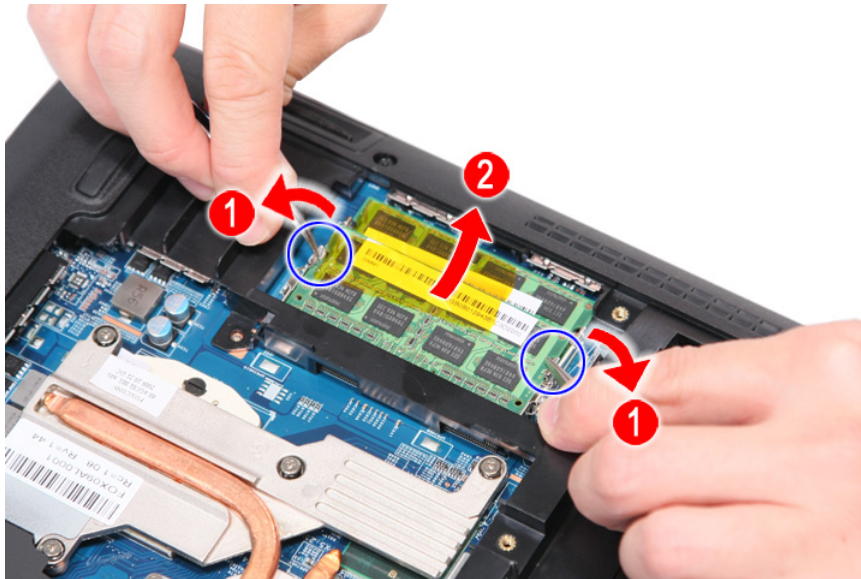

4. Remove the DIMM module(s).

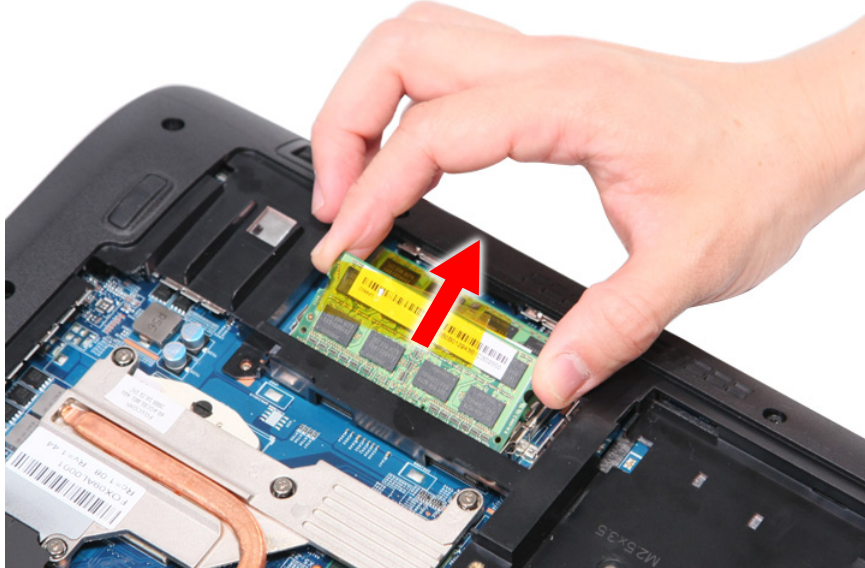

Main Unit Disassembly Process

Main Unit Disassembly Flowchart

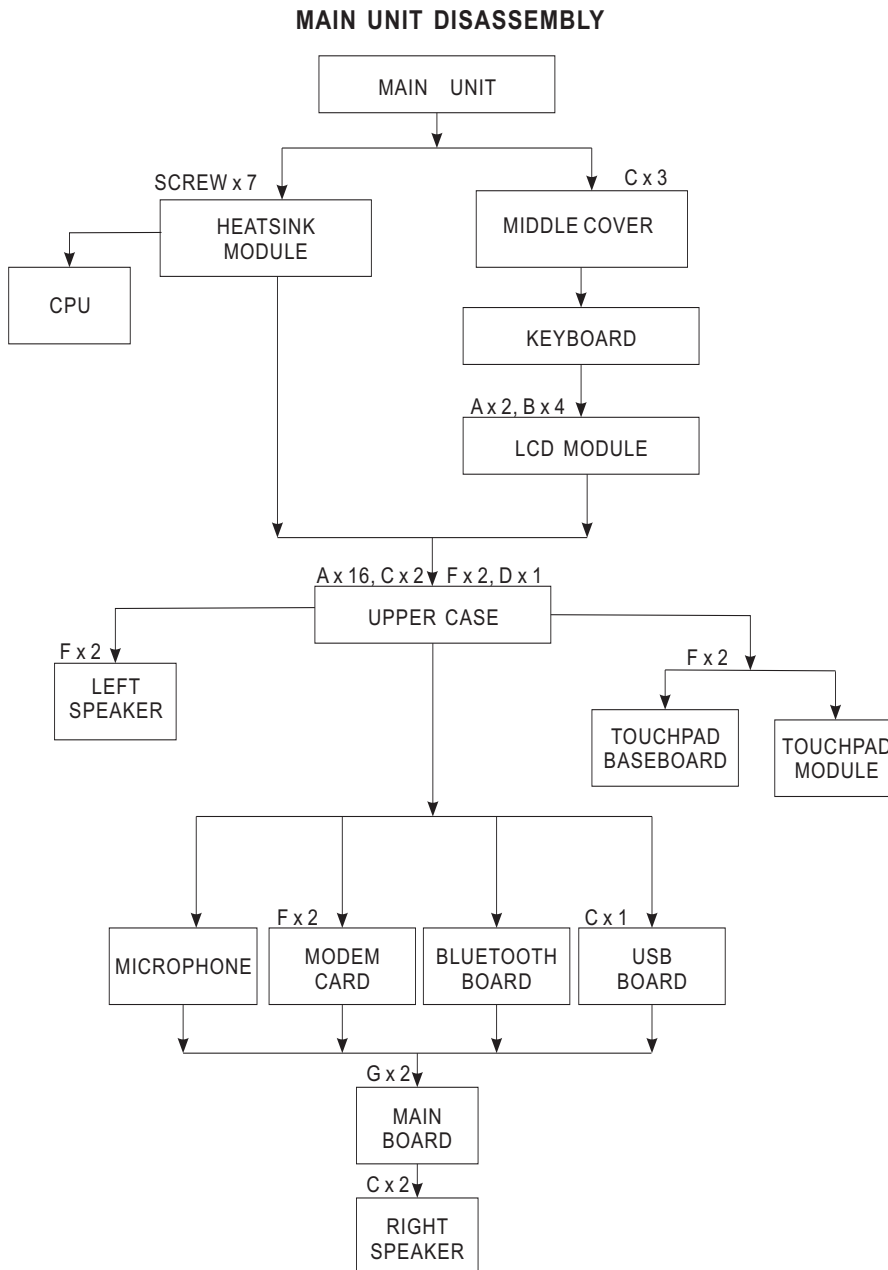

Item	Screw	Color	Part No.
A	M2.5 x L6	Black	86.00E12.536
B	M2.5 x L10	Black	86.00F84.73A
C	M2.5 x L4	Black	86.00H59.734
D	M2.5 x L3.5	Silver	86.9A563.3R5
F	M2 x L4	Silver	86.9A552.4R0
G	M2 x L3	Silver	86.9A522.3R0

Removing the Heatsink Module

NOTE: There are two version of heatsink module. For this section, we are going to use the Discrete model.
The UMA version looks like the picture below:



1. See “Removing the Battery Pack” on page 40.
2. See “Removing the Back Cover” on page 42.
3. Disconnect the heatsink connector from its connector on the main board.

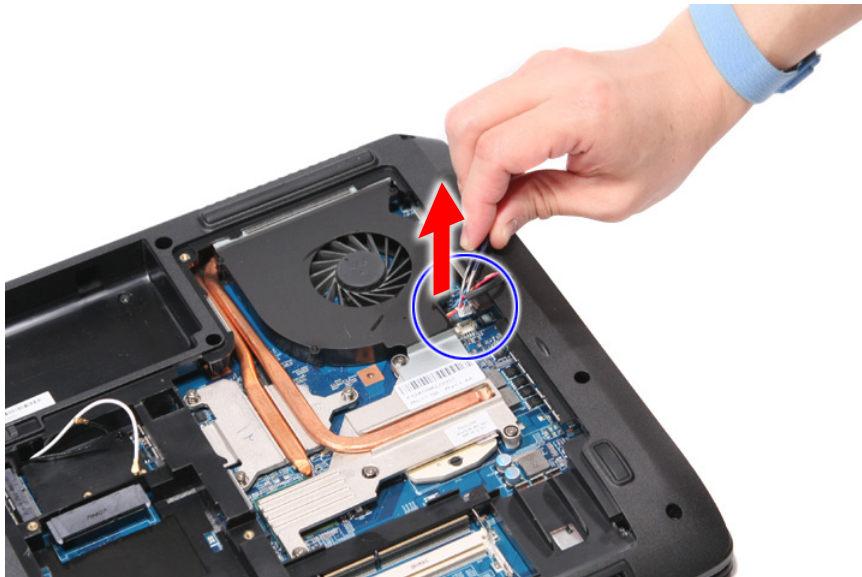

4. Loosen the seven screws securing the heatsink module in the order shown.

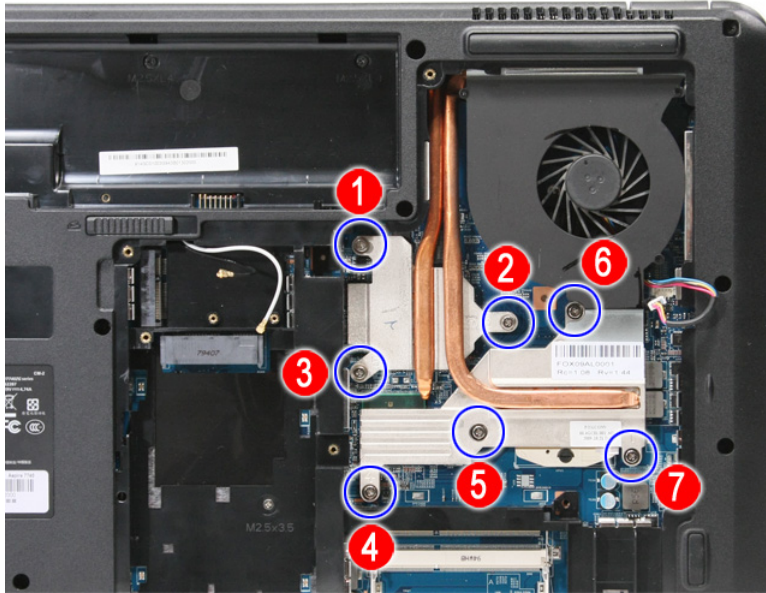

5. Carefully lift up the heatsink module.



Removing the CPU

1. See “Removing the Battery Pack” on page 40.
2. See “Removing the Back Cover” on page 42.
3. See “Removing the Heatsink Module” on page 49.
4. Using a flat screwdriver, turn the CPU socket latch counter-clockwise to release the CPU.

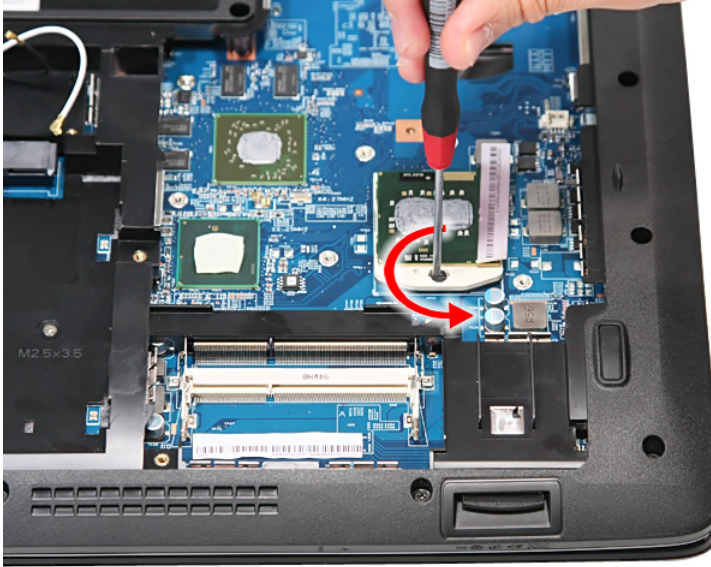

5. Lift up carefully to remove the CPU.



NOTE: When installing the CPU, make sure to install the CPU with Pin 1 at the corner as shown.

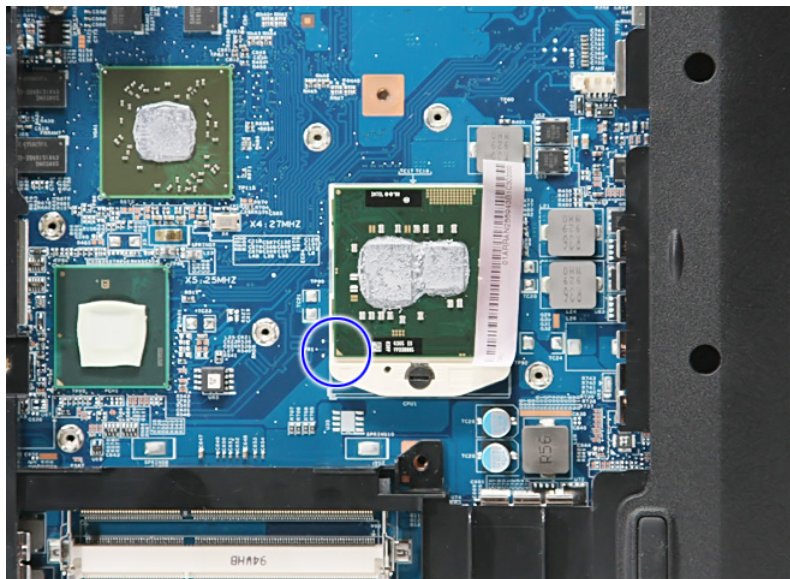

Removing the Middle Cover

1. See “Removing the Battery Pack” on page 40.
2. Remove the three screws (C) on the back cover.



Size (Quantity)	Color	Torque	Part No.
M2.5 x L4 (3)	Black	3.0 kgf-cm	86.00H59.734

3. Carefully pry loose the middle cover and remove it from the system.



Removing the Keyboard

1. See “Removing the Battery Pack” on page 40.
2. See “Removing the Middle Cover” on page 53.

3. Release the keyboard from the latches and turn it over on the palmrest area.

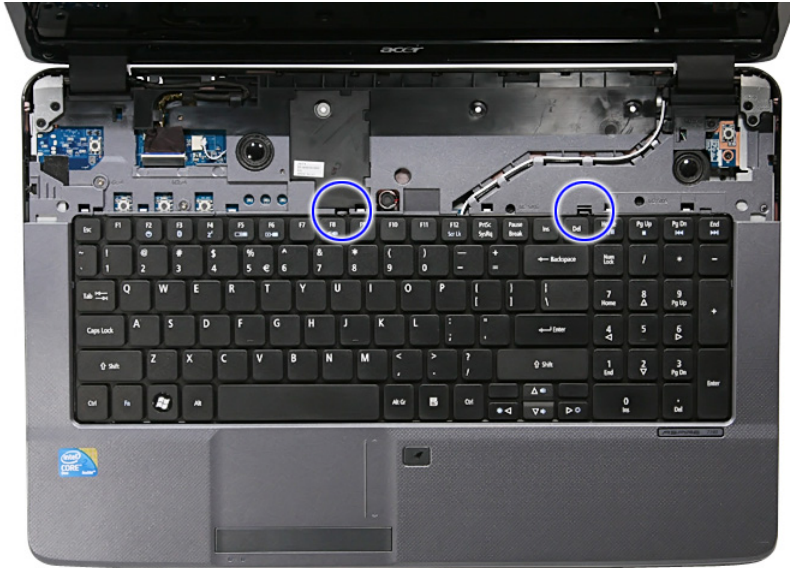

4. Release the latch and disconnect the keyboard cable from its connector on the main board and detach the keyboard.

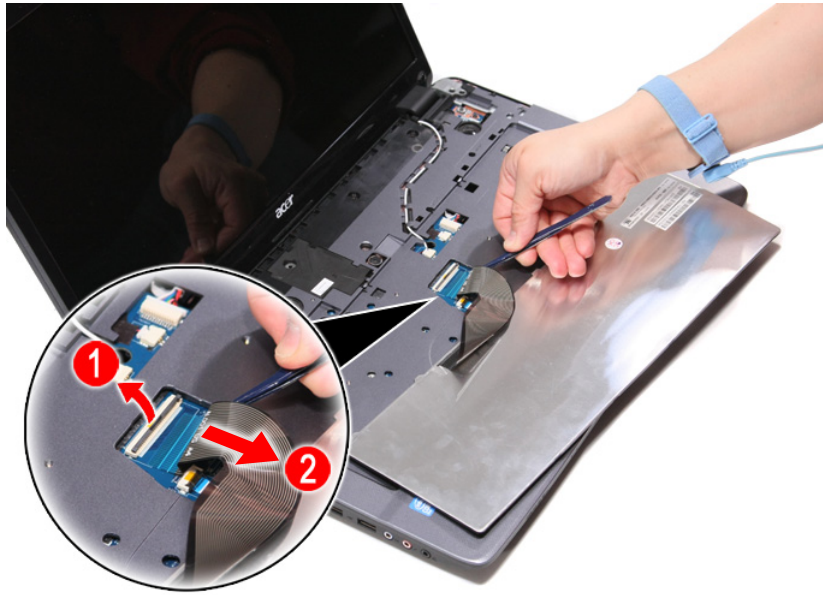

Removing the LCD Module

1. See “Removing the Battery Pack” on page 40.
2. See “Removing the Back Cover” on page 42.
3. See “Removing the Wireless LAN Card” on page 44.
4. See “Removing the Middle Cover” on page 53.
5. See “Removing the Keyboard” on page 53.
6. Remove the two screws (A) the LCD hinges from the bottom panel.



Size (Quantity)	Color	Torque	Part No.
M2.5 x L6 (3)	Black	3.0 kgf-cm	86.00E12.536

-
7. Turn the system over and disconnect the LCD cable from the LCD1 connector on the main board and release the LCD cable from the latches.



8. Carefully pull out the wireless antenna cables from the hole and release the cables from the latches.



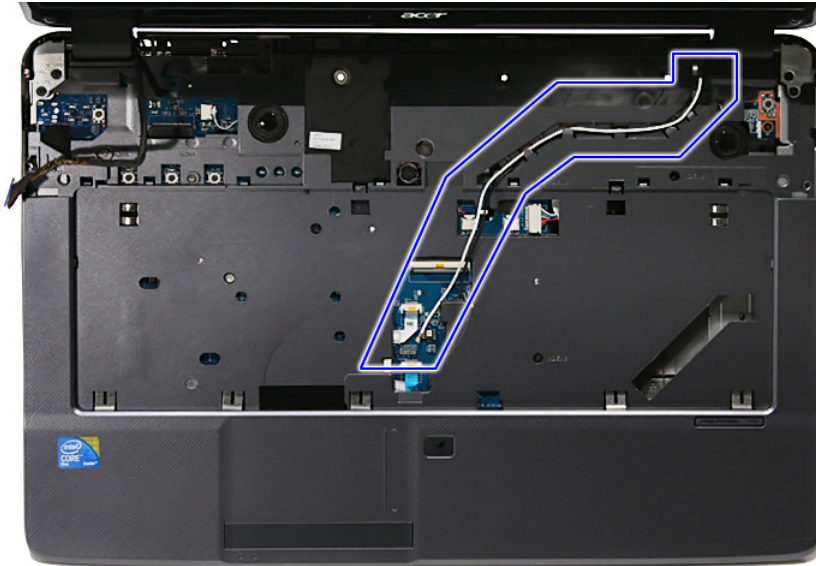

9. Remove the four screws (B) from the left and right hinges.

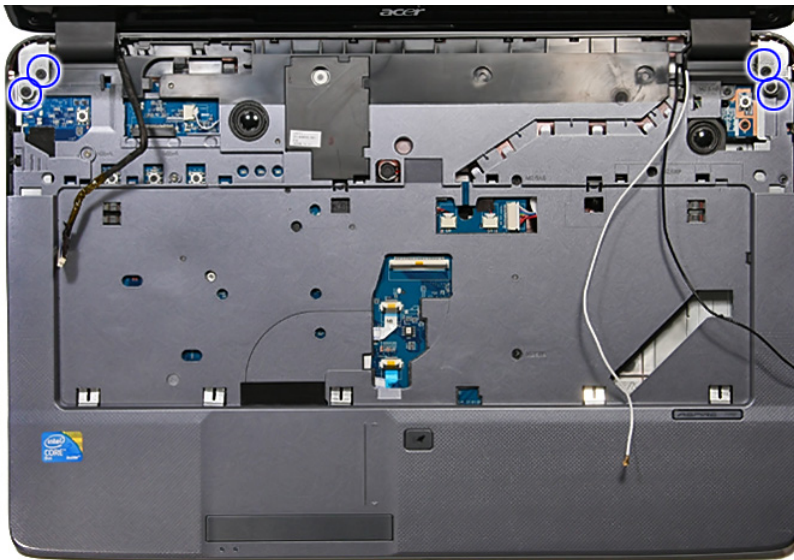

Size (Quantity)	Color	Torque	Part No.
M2.5 x L10 (4)	Black	3.0 kgf-cm	86.00F84.73A

10. Carefully remove the LCD module from the base unit.



NOTE: When connecting the cables back to the unit, please note that the cables should be routed well.

Separating the Upper Case from the Lower Case

1. See “Removing the Battery Pack” on page 40.
2. See “Removing the Optical Drive Module” on page 41.
3. See “Removing the Back Cover” on page 42.
4. See “Removing the Hard Disk Drive Module” on page 43.
5. See “Removing the Wireless LAN Card” on page 44.
6. See “Removing the DIMM Module” on page 46.
7. See “Removing the Heatsink Module” on page 49.
8. See “Removing the CPU” on page 51.
9. See “Removing the Middle Cover” on page 53.
10. See “Removing the Keyboard” on page 53.
11. See “Removing the LCD Module” on page 55.

12. Disconnect the left speaker cable from SPKR_L1 on the main board.

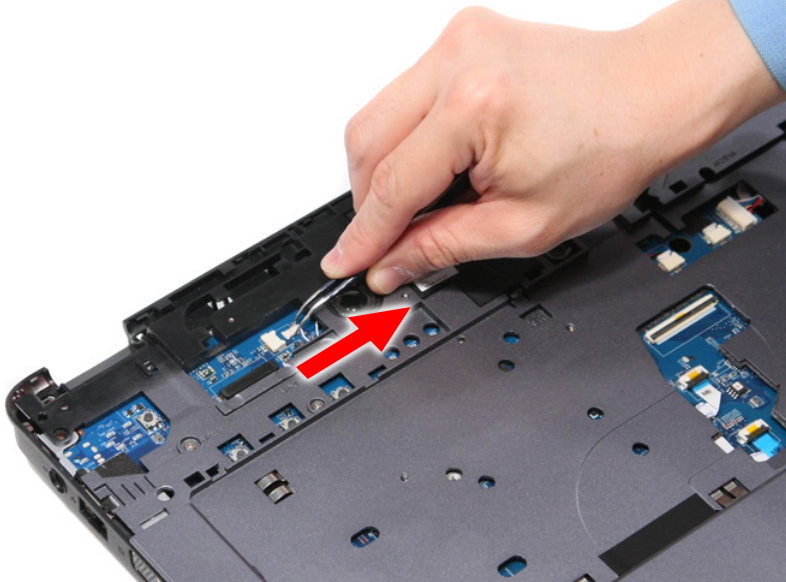

13. Release the latch and disconnect the touchpad cable TPCN1 connector on the main board.

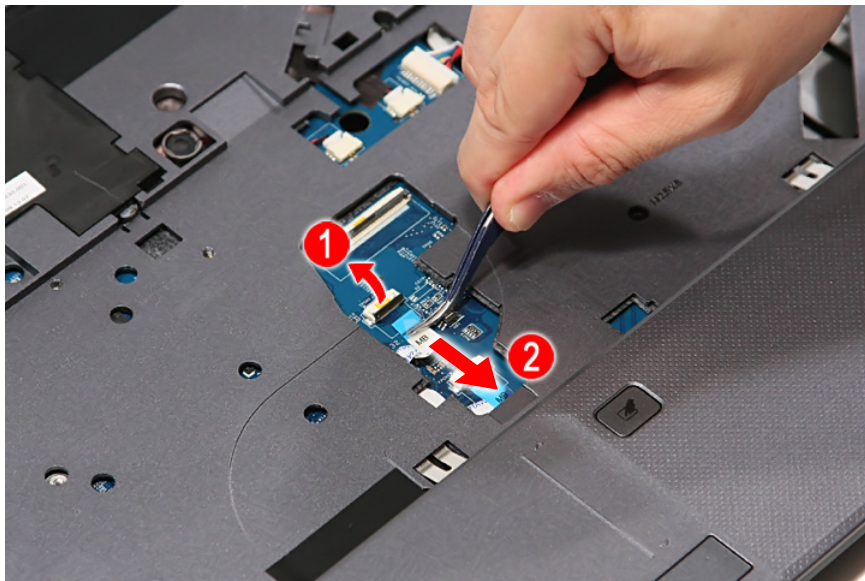

14. Release the latch and disconnect the touchpad button cable from FPCN1 connector on the main board.

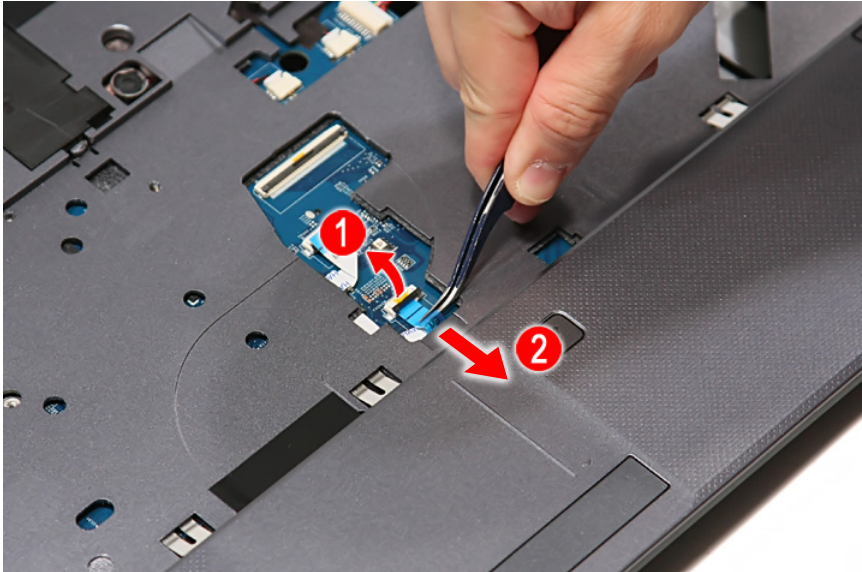

15. Remove the fifteen screws (12 x A, 2 x C, 1 x D) from the bottom panel.

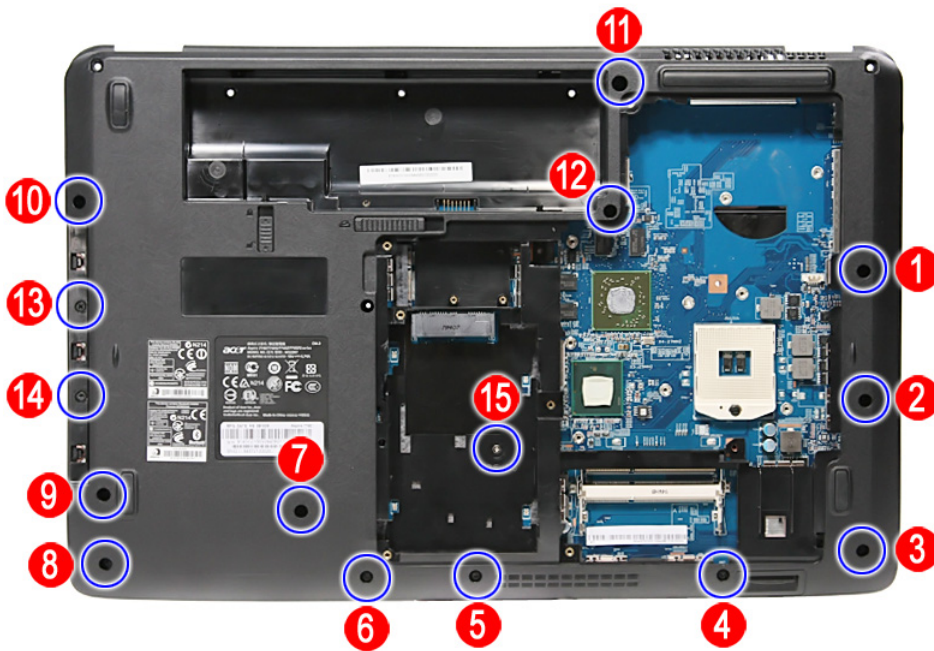

Size (Quantity)	Color	Torque	Part No.
M2.5 x L6 (12)	Black	3.0 kgf-cm	86.00E12.536
M2.5 x L4 (2)	Black	3.0 kgf-cm	86.00H59.734
M2.5 x L3.5 (1)	Silver	3.0 kgf-cm	86.9A563.3R5

16. Remove the six screws (4 x A, 2 x F) securing the the upper case to the system.

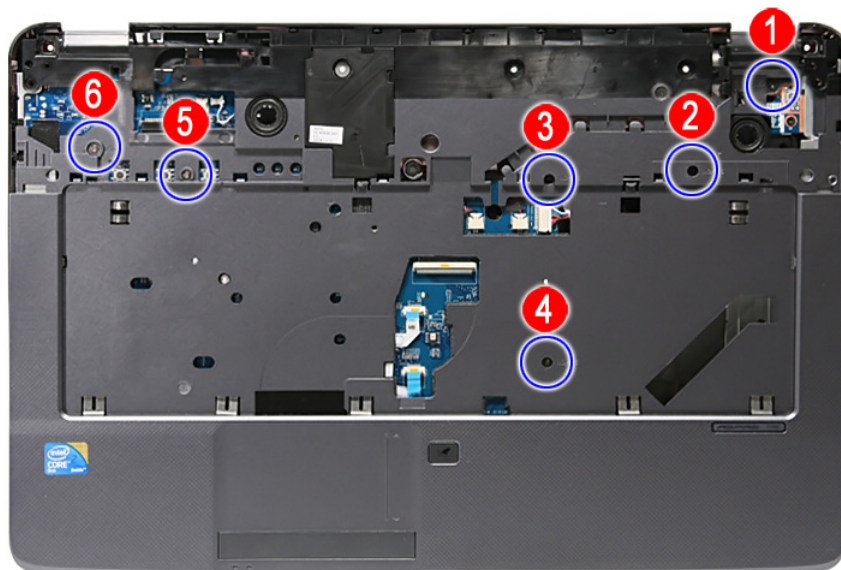

Size (Quantity)	Color	Torque	Part No.
M2.5 x L6 (4)	Black	3.0 kgf-cm	86.00E12.536
M2 x L4 (2)	Silver	1.6 kgf-cm	86.9A552.4R0

17. Gently lift and detach the upper case from the lower case.

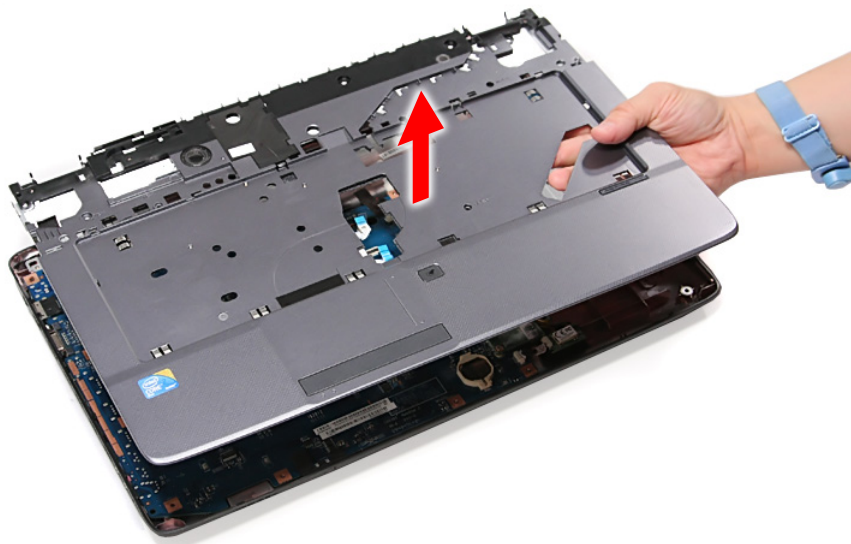

Removing the Touchpad and Button Boards

1. See “Removing the Battery Pack” on page 40.
2. See “Removing the Optical Drive Module” on page 41.
3. See “Removing the Back Cover” on page 42.
4. See “Removing the Hard Disk Drive Module” on page 43.
5. See “Removing the Wireless LAN Card” on page 44.
6. See “Removing the DIMM Module” on page 46.
7. See “Removing the Heatsink Module” on page 49.

8. See “Removing the CPU” on page 51.
9. See “Removing the Middle Cover” on page 53.
10. See “Removing the Keyboard” on page 53.
11. See “Removing the LCD Module” on page 55.
12. See “Separating the Upper Case from the Lower Case” on page 58.
13. Release the latch and disconnect the touchpad button board cable from the connector.

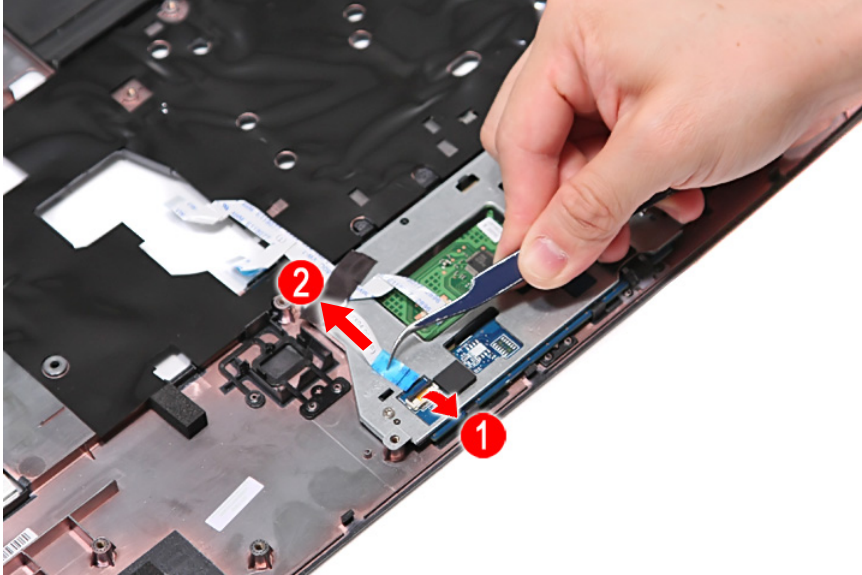

14. Remove the tape securing the cables in place.



15. The cables are tape to the uppercase, carefully peel off the cables.

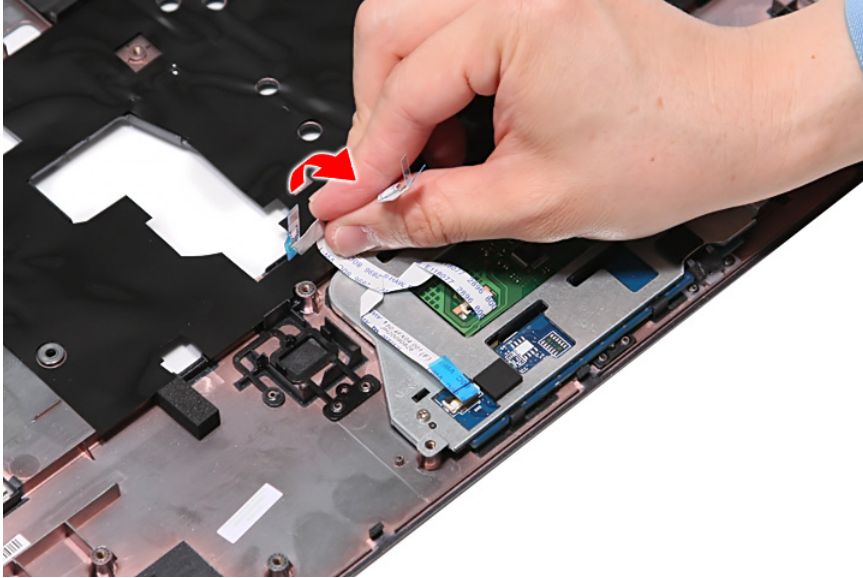

16. Release the latch and disconnect the touchpad cable from the connector.

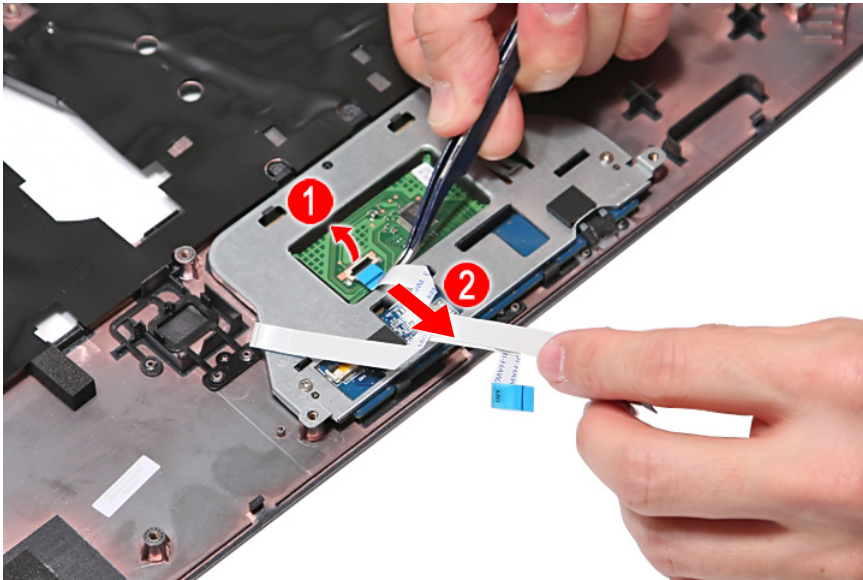

17. Release from the latches and remove the two screws (F) securing the touchpad and touchpad button bracket to the upper case.

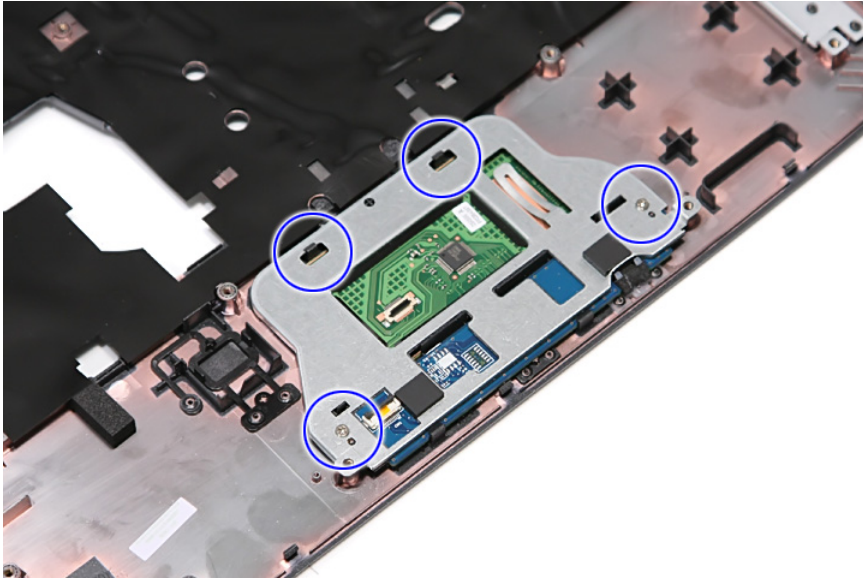

Size (Quantity)	Color	Torque	Part No.
M2 x L4 (2)	Silver	1.6 kgf-cm	86.9A552.4R0

18. Release from the latches and detach the touchpad and button board bracket.

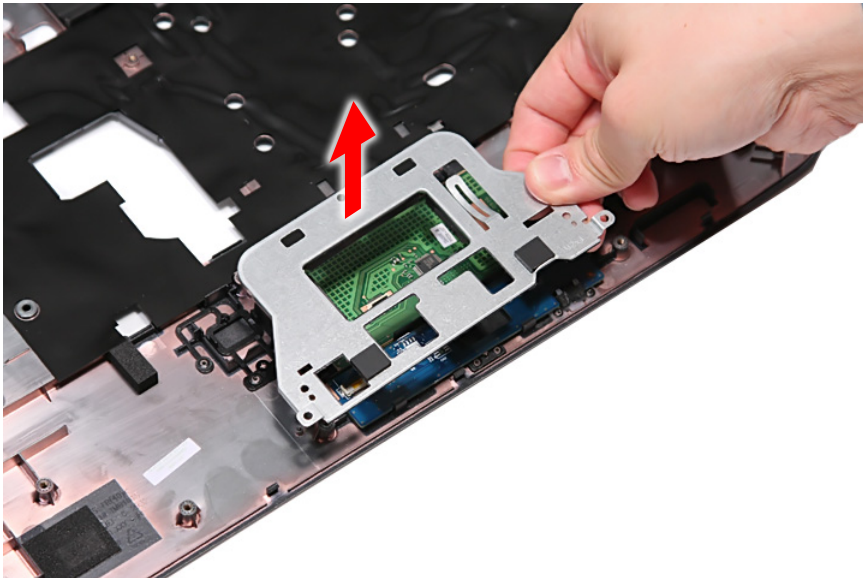

19. Release from the latches and detach the button board.

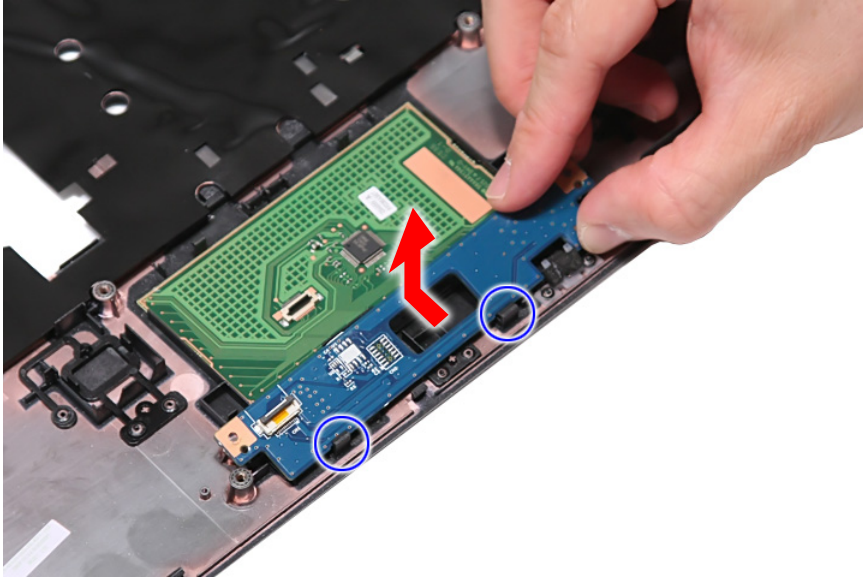

20. Pry to loosen the touchpad board.

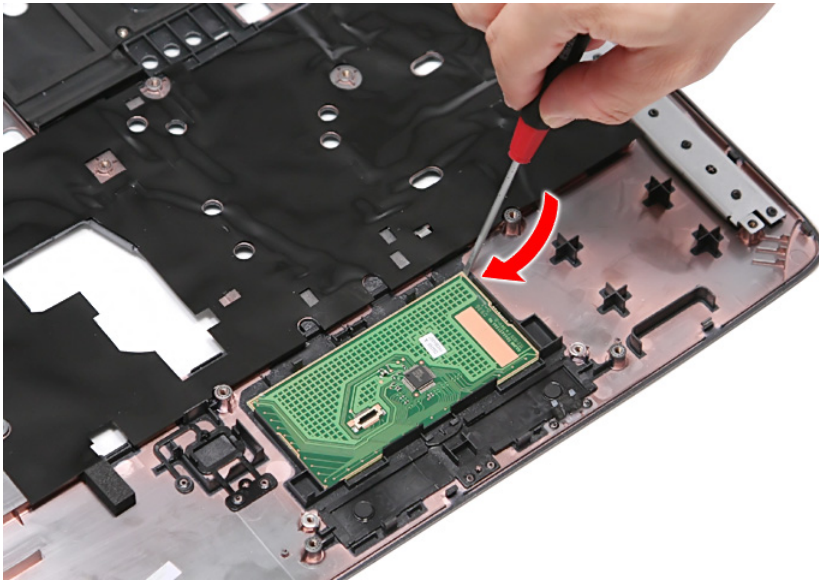

WARNING: The touchpad board is glued to the upper case, only remove the touchpad board if it is defective.

21. Detach the touchpad board from the upper case.

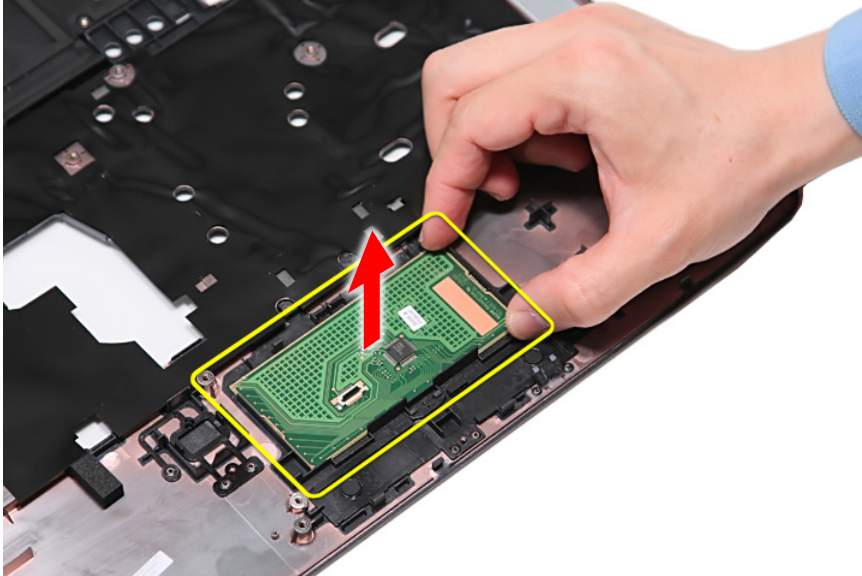

Note: Circuit boards > 10cm² has been highlighted with the yellow square as shown in the figure above. Please detach the circuit boards and follow the local regulations for disposal.

Removing the Left Speaker

1. See “Removing the Battery Pack” on page 40.
2. See “Removing the Optical Drive Module” on page 41.
3. See “Removing the Back Cover” on page 42.
4. See “Removing the Hard Disk Drive Module” on page 43.
5. See “Removing the Wireless LAN Card” on page 44.
6. See “Removing the DIMM Module” on page 46.
7. See “Removing the Heatsink Module” on page 49.
8. See “Removing the CPU” on page 51.
9. See “Removing the Middle Cover” on page 53.
10. See “Removing the Keyboard” on page 53.
11. See “Removing the LCD Module” on page 55.
12. See “Separating the Upper Case from the Lower Case” on page 58.

13. Remove the two screws (F) securing the left speaker to the upper case.

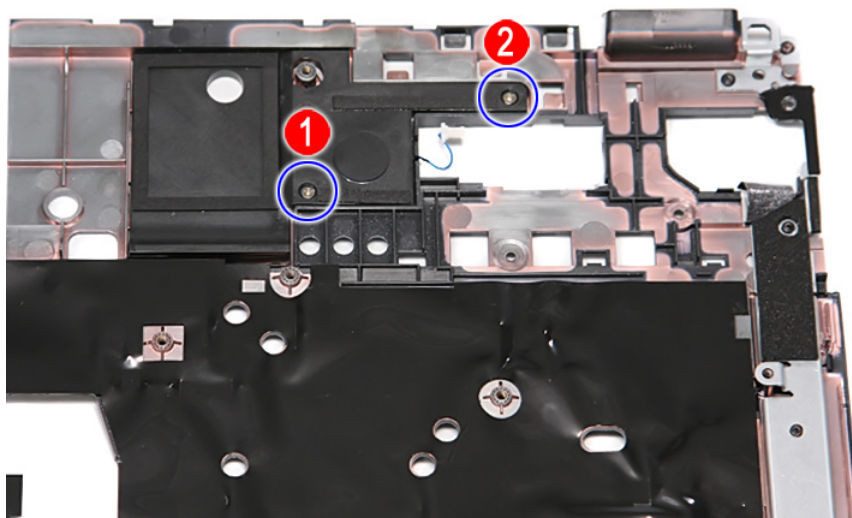

Size (Quantity)	Color	Torque	Part No.
M2 x L4 (2)	Silver	1.6 kgf-cm	86.9A552.4R0

14. Remove the left speaker from the upper board.

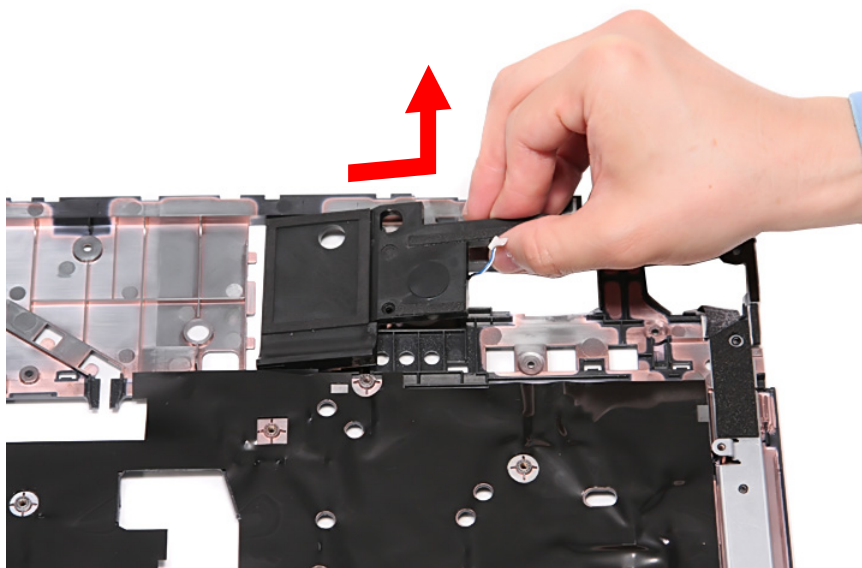

NOTE: Be careful when removing the left speaker as it is held in place by plastic tabs.

Removing the USB Board Module

1. See “Removing the Battery Pack” on page 40.
2. See “Removing the Optical Drive Module” on page 41.
3. See “Removing the Back Cover” on page 42.
4. See “Removing the Hard Disk Drive Module” on page 43.
5. See “Removing the Wireless LAN Card” on page 44.
6. See “Removing the DIMM Module” on page 46.

7. See “Removing the Heatsink Module” on page 49.
8. See “Removing the CPU” on page 51.
9. See “Removing the Middle Cover” on page 53.
10. See “Removing the Keyboard” on page 53.
11. See “Removing the LCD Module” on page 55.
12. See “Separating the Upper Case from the Lower Case” on page 58.
13. Disconnect the USB board cable from the main board.

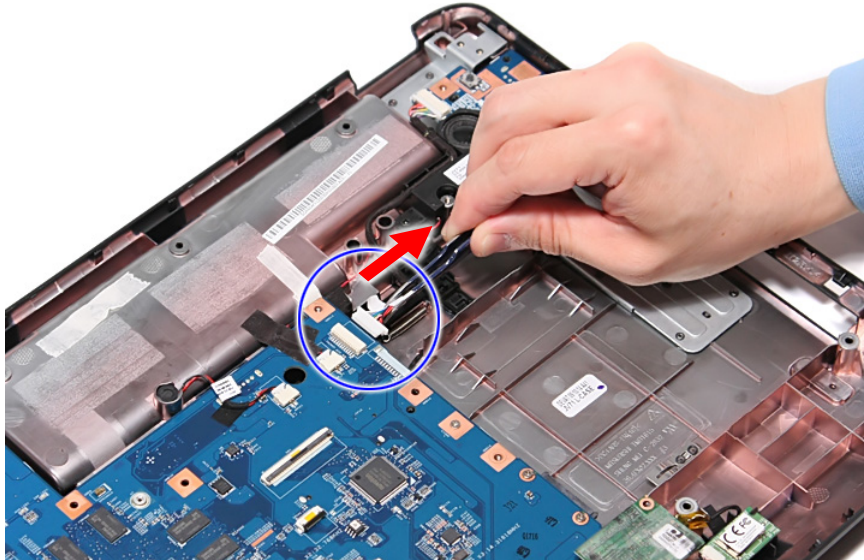

14. Remove the one screw (C) securing the USB board to the lower case.

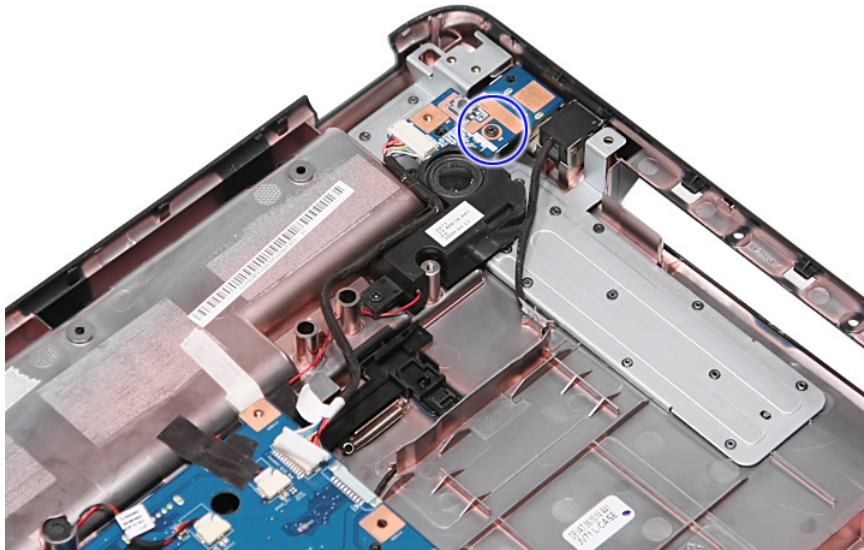

Size (Quantity)	Color	Torque	Part No.
M2.5 x L4 (1)	Black	3.0 kgf-cm	86.00H59.734

15. Remove the USB board module from the lower case.

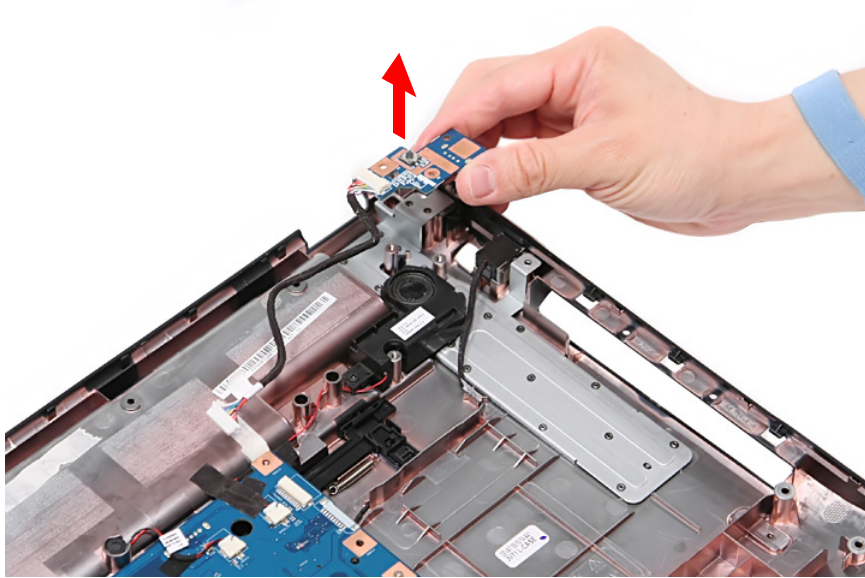

Removing the Modem Board

1. See “Removing the Battery Pack” on page 40.
2. See “Removing the Optical Drive Module” on page 41.
3. See “Removing the Back Cover” on page 42.
4. See “Removing the Hard Disk Drive Module” on page 43.
5. See “Removing the Wireless LAN Card” on page 44.
6. See “Removing the DIMM Module” on page 46.
7. See “Removing the Heatsink Module” on page 49.
8. See “Removing the CPU” on page 51.
9. See “Removing the Middle Cover” on page 53.
10. See “Removing the Keyboard” on page 53.
11. See “Removing the LCD Module” on page 55.
12. See “Separating the Upper Case from the Lower Case” on page 58.
13. Remove the one screw (F) securing the modem board module to the lower case.



Size (Quantity)	Color	Torque	Part No.
M2 x L4 (1)	Silver	1.6 kgf-cm	86.9A552.4R0

14. Remove the modem board from the lower case.

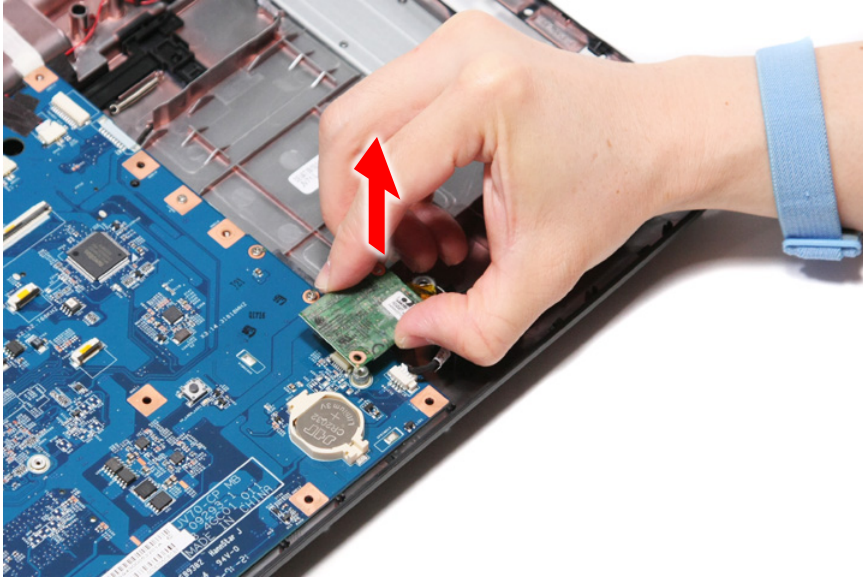

15. Disconnect the modem cable from the modem board.



Removing the Bluetooth Module

1. See “Removing the Battery Pack” on page 40.
2. See “Removing the Optical Drive Module” on page 41.
3. See “Removing the Back Cover” on page 42.
4. See “Removing the Hard Disk Drive Module” on page 43.
5. See “Removing the Wireless LAN Card” on page 44.
6. See “Removing the DIMM Module” on page 46.
7. See “Removing the Heatsink Module” on page 49.
8. See “Removing the CPU” on page 51.
9. See “Removing the Middle Cover” on page 53.

10. See “Removing the Keyboard” on page 53.
11. See “Removing the LCD Module” on page 55.
12. See “Separating the Upper Case from the Lower Case” on page 58.
13. Disconnect the Bluetooth cable from the main board.



14. Remove the Bluetooth module from the lower case.

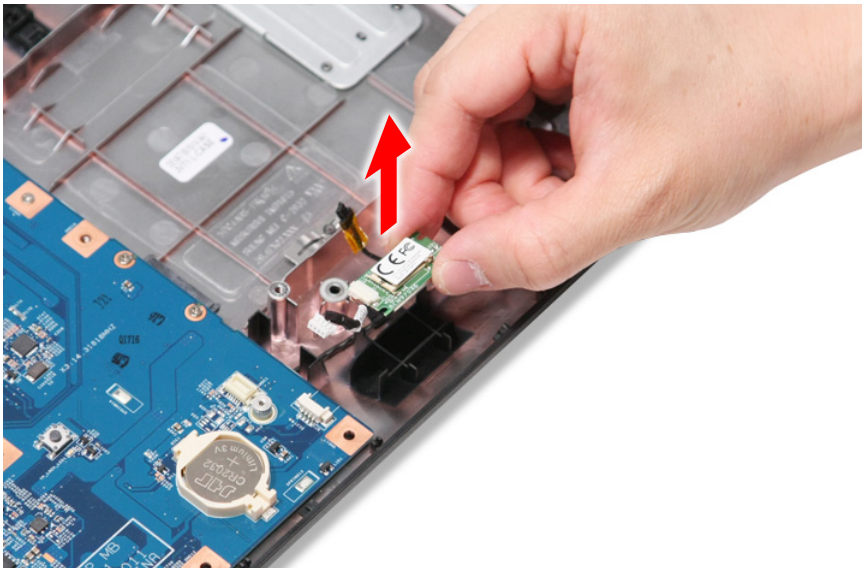

NOTE: The Bluetooth module is glued to the lower case, take care when removing it.

Removing the Microphone

1. See “Removing the Battery Pack” on page 40.
2. See “Removing the Optical Drive Module” on page 41.
3. See “Removing the Back Cover” on page 42.
4. See “Removing the Hard Disk Drive Module” on page 43.
5. See “Removing the Wireless LAN Card” on page 44.
6. See “Removing the DIMM Module” on page 46.

7. See “Removing the Heatsink Module” on page 49.
8. See “Removing the CPU” on page 51.
9. See “Removing the Middle Cover” on page 53.
10. See “Removing the Keyboard” on page 53.
11. See “Removing the LCD Module” on page 55.
12. See “Separating the Upper Case from the Lower Case” on page 58.
13. Remove the tape securing the microphone cable.

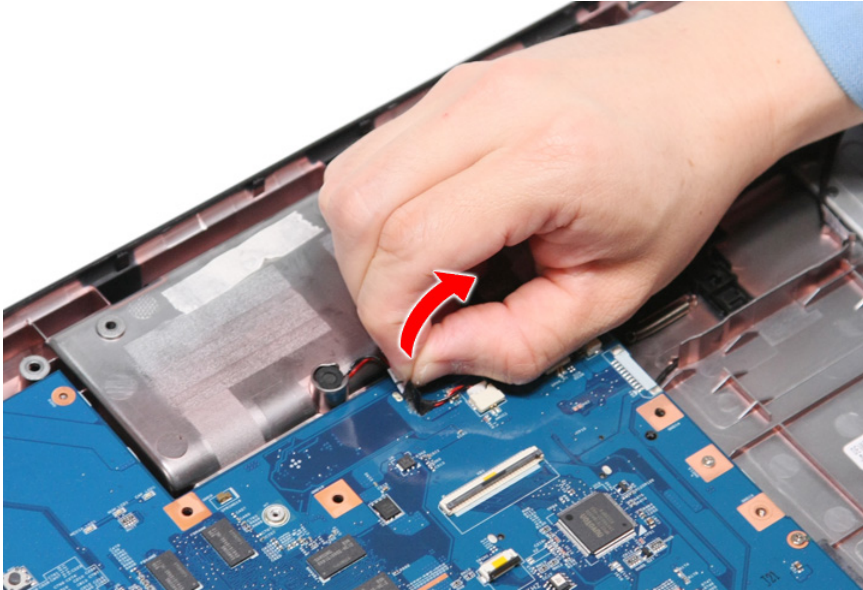

14. Disconnect the microphone cable from the main board.

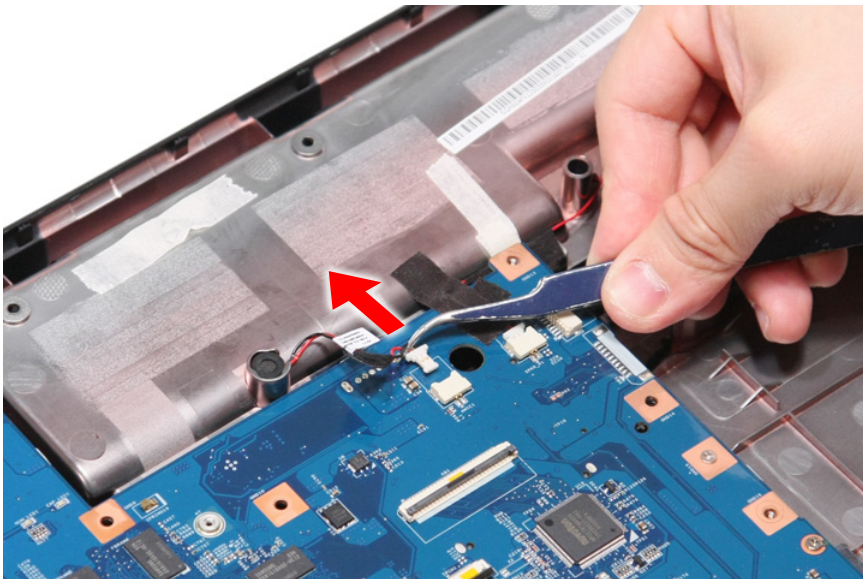

-
15. Remove the microphone from the system.

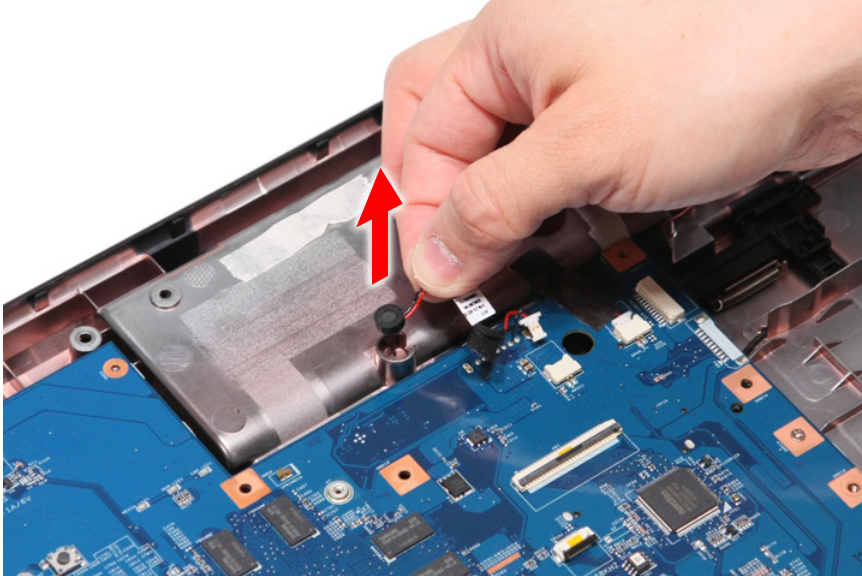

Removing the Main Board

1. See “Removing the Battery Pack” on page 40.
2. See “Removing the Optical Drive Module” on page 41.
3. See “Removing the Back Cover” on page 42.
4. See “Removing the Hard Disk Drive Module” on page 43.
5. See “Removing the Wireless LAN Card” on page 44.
6. See “Removing the DIMM Module” on page 46.
7. See “Removing the Heatsink Module” on page 49.
8. See “Removing the CPU” on page 51.
9. See “Removing the Middle Cover” on page 53.
10. See “Removing the Keyboard” on page 53.
11. See “Removing the LCD Module” on page 55.
12. See “Separating the Upper Case from the Lower Case” on page 58.
13. See “Removing the USB Board Module” on page 67.
14. See “Removing the Modem Board” on page 70.
15. See “Removing the Bluetooth Module” on page 71.
16. See “Removing the Microphone” on page 72.

17. Remove the tape securing the right speaker cable to the main board.

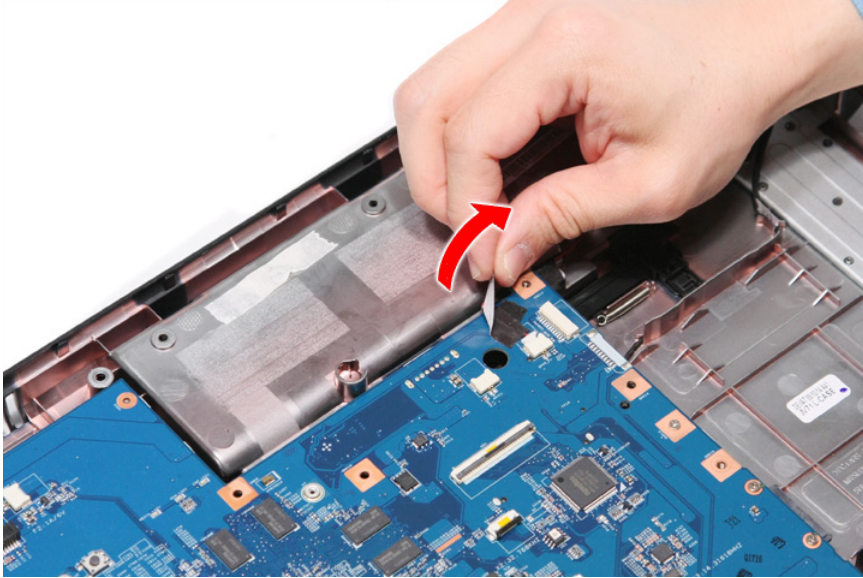

18. Disconnect the right speaker cable from the main board.

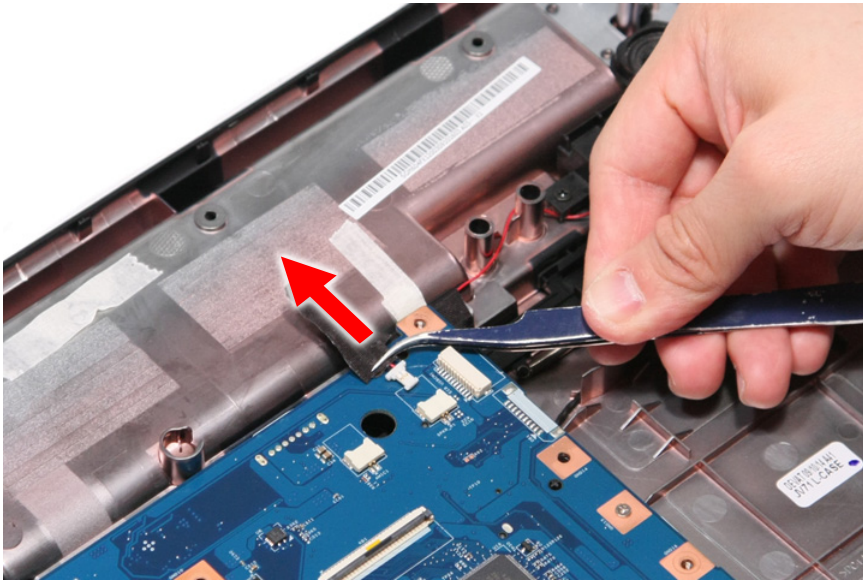

19. Remove the one screw (G) securing the main board in place.



Size (Quantity)	Color	Torque	Part No.
M2 x L3 (1)	Silver	1.6 kgf-cm	86.9A522.3R0

20. Lift the main board gently and remove it carefully from the lower case..



Note: RTC battery has been highlighted with the yellow circle as shown in the figure above. Please detach the RTC battery and follow local regulations for disposal.



Note: Circuit boards > 10cm² has been highlighted with the yellow square as shown in the figure above. Please detach the circuit boards and follow the local regulations for disposal.

Removing the Right Speaker

1. See “Removing the Battery Pack” on page 40.
2. See “Removing the Optical Drive Module” on page 41.
3. See “Removing the Back Cover” on page 42.
4. See “Removing the Hard Disk Drive Module” on page 43.
5. See “Removing the Wireless LAN Card” on page 44.
6. See “Removing the DIMM Module” on page 46.
7. See “Removing the Heatsink Module” on page 49.
8. See “Removing the CPU” on page 51.
9. See “Removing the Middle Cover” on page 53.
10. See “Removing the Keyboard” on page 53.
11. See “Removing the LCD Module” on page 55.
12. See “Separating the Upper Case from the Lower Case” on page 58.
13. See “Removing the USB Board Module” on page 67.
14. See “Removing the Modem Board” on page 70.
15. See “Removing the Bluetooth Module” on page 71.
16. See “Removing the Microphone” on page 72.
17. See “Removing the Main Board” on page 74.
18. Remove the tapes securing the right speaker cables to the lower case.



19. Remove the two screws (C) securing the right speaker to the lower case.

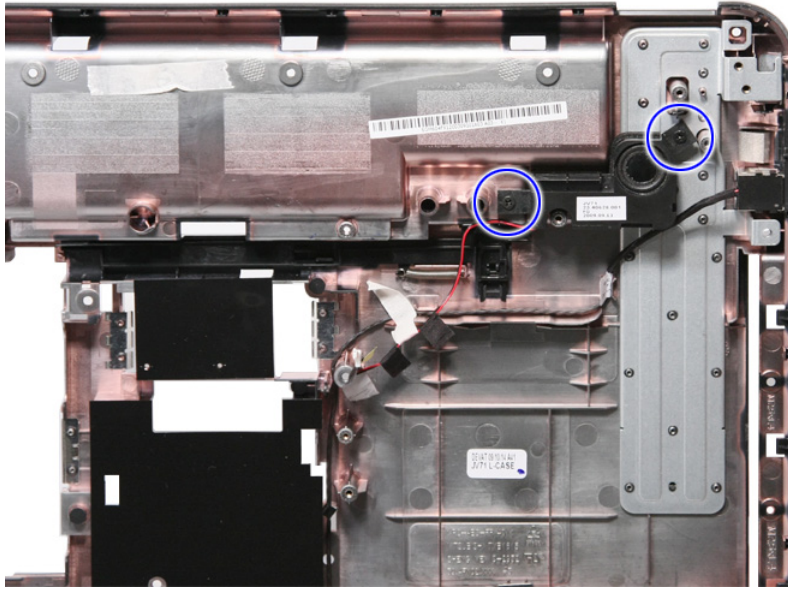

Size (Quantity)	Color	Torque	Part No.
M2.5 x L4 (2)	Black	3.0 kgf-cm	86.00H59.734

20. Remove the right speaker from the lower case.

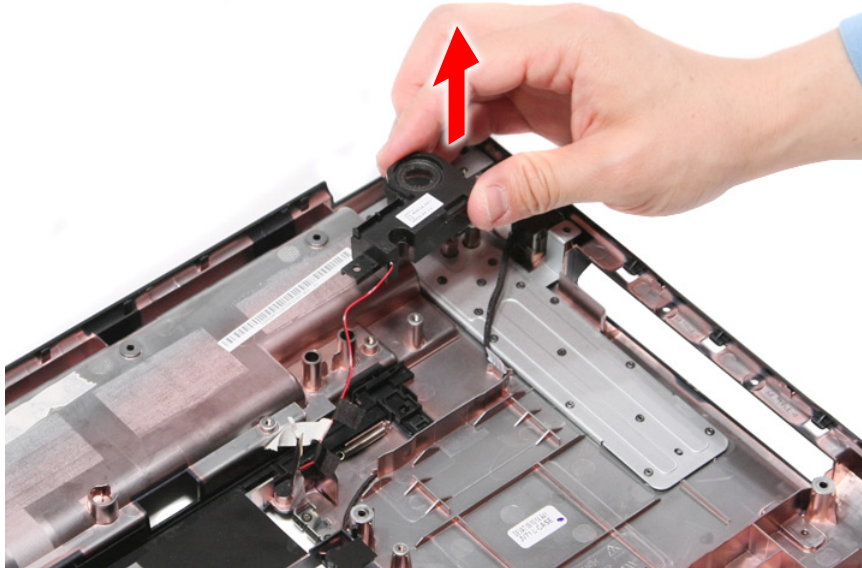

LCD Module Disassembly Process

LCD Module Disassembly Flowchart

LCD MODULE DISASSEMBLY

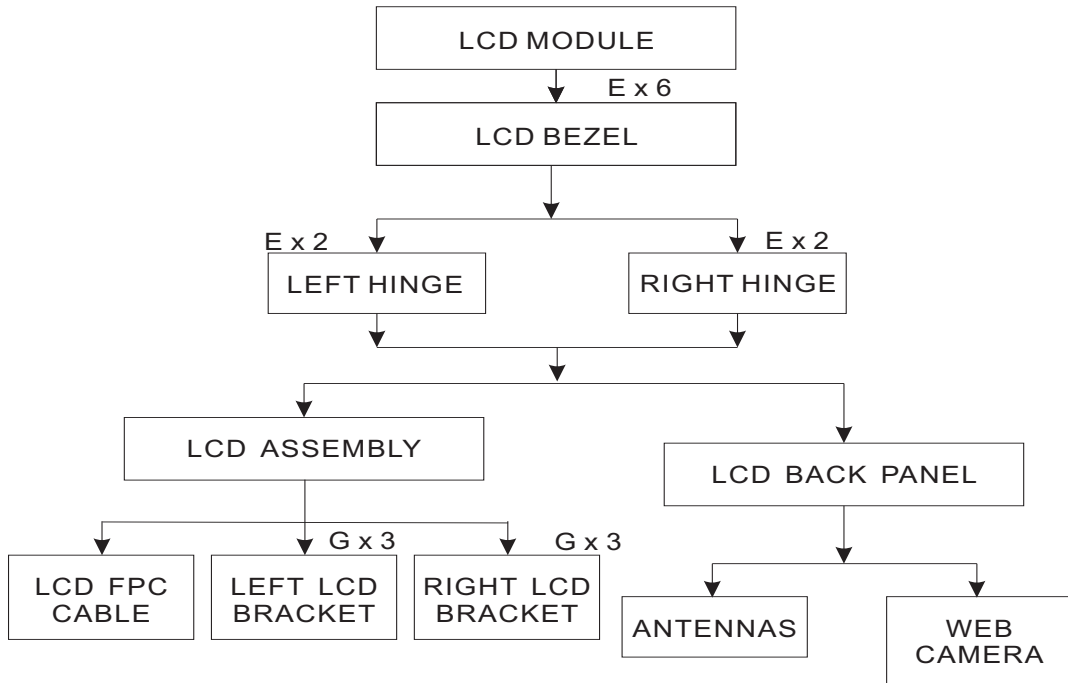

Item	Screw	Color	Part No.
E	M2.5 x L5	Black	86.00F87.735
G	M2 x L3	Silver	86.9A522.3R0

Removing the LCD Bezel

1. See “Removing the Battery Pack” on page 40.
2. See “Removing the Back Cover” on page 42.
3. See “Removing the Wireless LAN Card” on page 44.
4. See “Removing the Middle Cover” on page 53.
5. See “Removing the Keyboard” on page 53.
6. See “Removing the LCD Module” on page 55.
7. Remove the six rubber screw covers at the top and bottom of the LCD bezel.



8. Remove the six screws (E) at the top and bottom of the LCD bezel.



Size (Quantity)	Color	Torque	Part No.
M2.5 x L5 (6)	Black	3.0 kgf-cm	86.00F87.735

-
9. Carefully pry open the LCD bezel and remove it from the LCD panel.

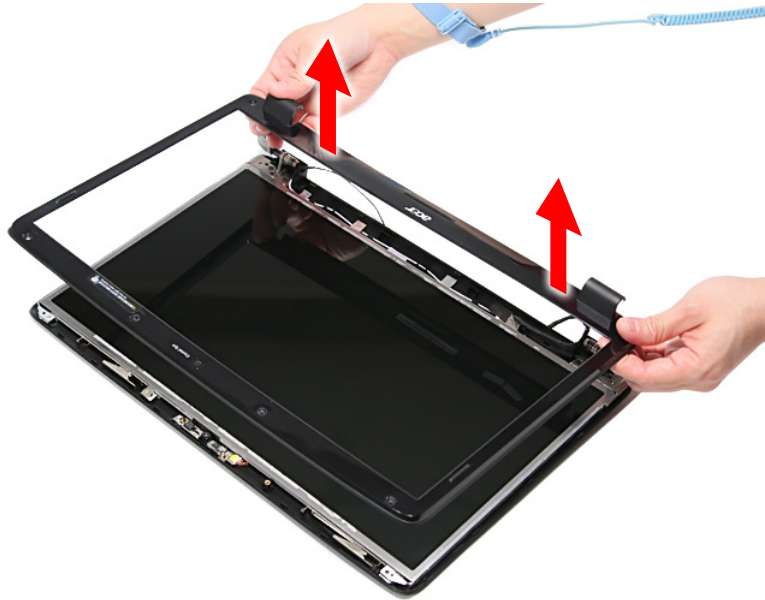

Removing the LCD panel with the Brackets

1. See “Removing the Battery Pack” on page 40.
2. See “Removing the Back Cover” on page 42.
3. See “Removing the Wireless LAN Card” on page 44.
4. See “Removing the Middle Cover” on page 53.
5. See “Removing the Keyboard” on page 53.
6. See “Removing the LCD Module” on page 55.
7. See “Removing the LCD Bezel” on page 80.

8. Remove the four screws (E) on the left and right hinges as shown.



Size (Quantity)	Color	Torque	Part No.
M2.5 x L5 (4)	Black	3.0 kgf-cm	86.00F87.735

9. Detach the webcam cable from the webcam module.



10. Remove the LCD panel with brackets from the back cover.



Removing the LCD Brackets

1. See “Removing the Battery Pack” on page 40.
2. See “Removing the Back Cover” on page 42.
3. See “Removing the Wireless LAN Card” on page 44.
4. See “Removing the Middle Cover” on page 53.
5. See “Removing the Keyboard” on page 53.
6. See “Removing the LCD Module” on page 55.
7. See “Removing the LCD Bezel” on page 80.
8. See “Removing the LCD panel with the Brackets” on page 81.
9. Remove the six screws (G) securing the left and right LCD brackets; then remove the left and right brackets.

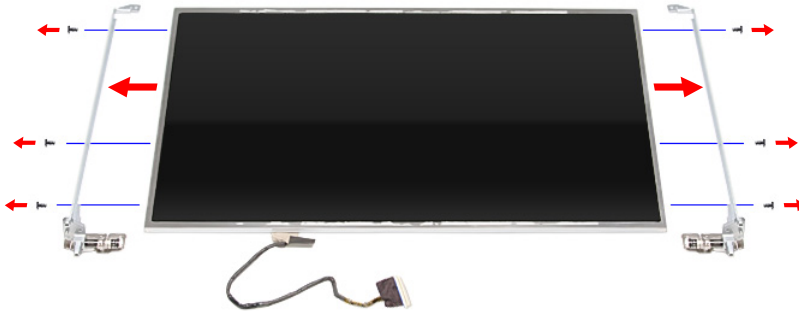

Size (Quantity)	Color	Torque	Part No.
M2 x L3 (G)	Silver	1.6 kgf-cm	86.9A522.3R0

Removing the FPC Cable

1. See “Removing the Battery Pack” on page 40.
2. See “Removing the Back Cover” on page 42.
3. See “Removing the Wireless LAN Card” on page 44.
4. See “Removing the Middle Cover” on page 53.
5. See “Removing the Keyboard” on page 53.
6. See “Removing the LCD Module” on page 55.
7. See “Removing the LCD Bezel” on page 80.
8. See “Removing the LCD panel with the Brackets” on page 81.
9. Detach all adhesive tapes and any cable that is glued to the LCD panel.

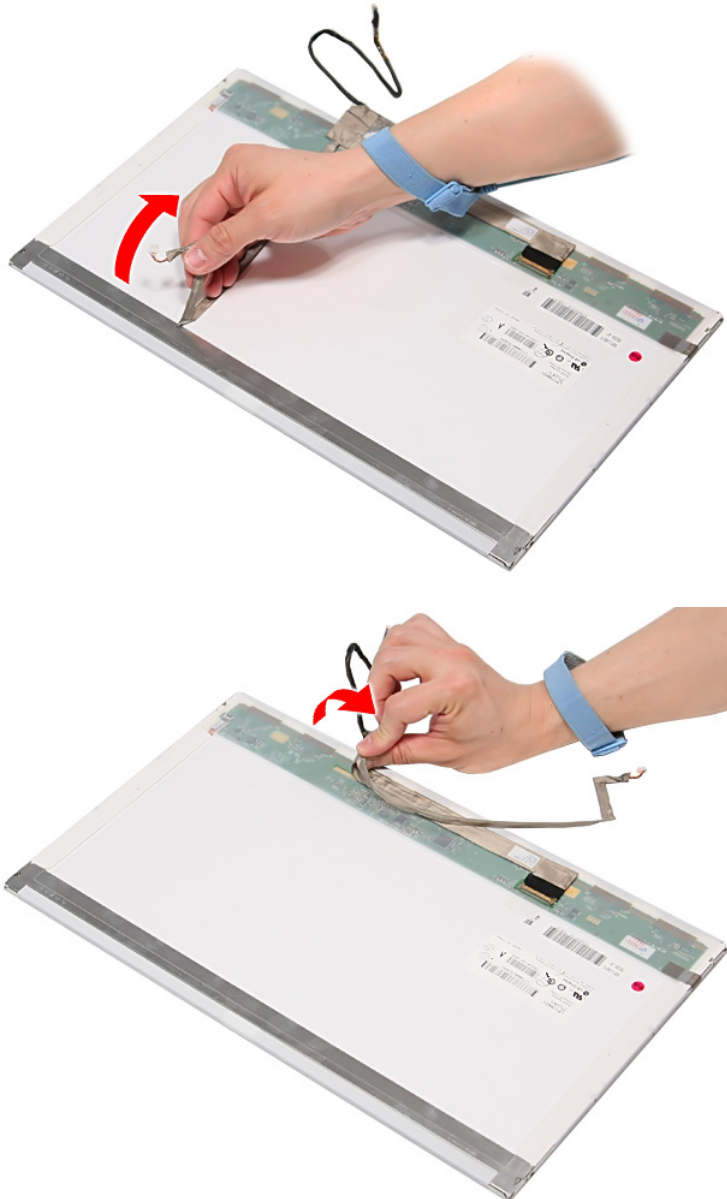

10. Remove the tape securing the FPC cable connector.



11. Disconnect the FPC cable from the LCD panel.



Removing the Web Camera

1. See “Removing the Battery Pack” on page 40.
2. See “Removing the Back Cover” on page 42.
3. See “Removing the Wireless LAN Card” on page 44.
4. See “Removing the Middle Cover” on page 53.
5. See “Removing the Keyboard” on page 53.
6. See “Removing the LCD Module” on page 55.
7. See “Removing the LCD Bezel” on page 80.
8. See “Removing the LCD panel with the Brackets” on page 81.

-
9. Remove the web camera module from the LCD module back cover.

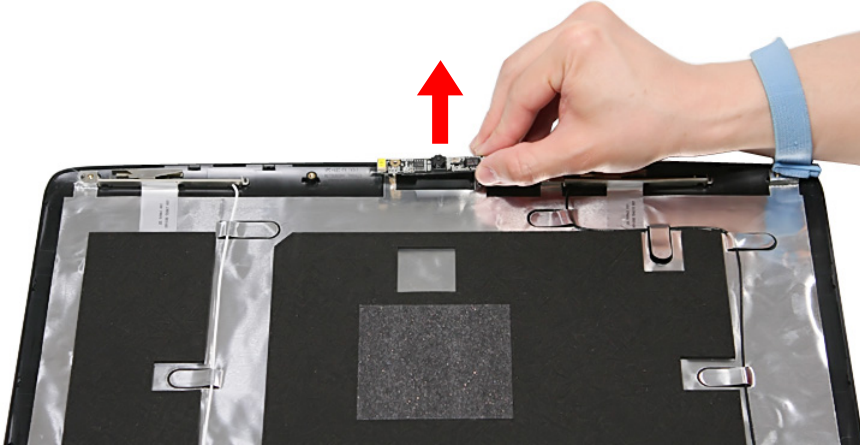

WARNING: The web camera module is glued to the LCD module back cover, only remove the web camera module if it is defective.

Removing the Antennas

1. See “Removing the Battery Pack” on page 40.
2. See “Removing the Back Cover” on page 42.
3. See “Removing the Wireless LAN Card” on page 44.
4. See “Removing the Middle Cover” on page 53.
5. See “Removing the Keyboard” on page 53.
6. See “Removing the LCD Module” on page 55.
7. See “Removing the LCD Bezel” on page 80.
8. See “Removing the LCD panel with the Brackets” on page 81.
9. Release the antenna cables from the aluminium notches and hinges.

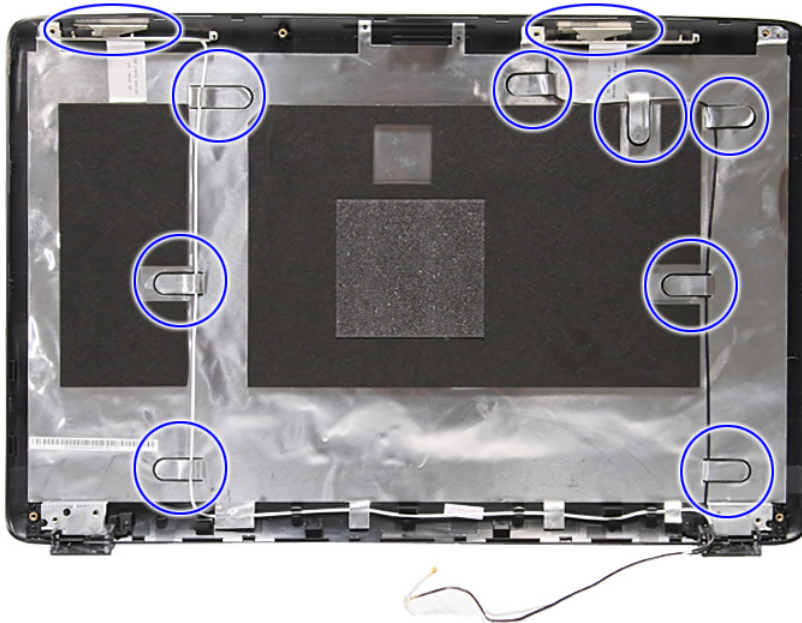

NOTE: There is no need to remove the antenna unless you really need to replace it.

Troubleshooting

Use the following procedure as a guide for computer problems.

NOTE: The diagnostic tests are intended to test only Acer products. Non-Acer products, prototype cards, or modified options can give false errors and invalid system responses.

1. Obtain the failing symptoms in as much detail as possible.
2. Verify the symptoms by attempting to re-create the failure by running the diagnostic test or by repeating the same operation.
3. Use the following table with the verified symptom to determine which page to go to.

Symptoms (Verified)	Go To
Power failure. (The power indicator does not go on or stay on.)	"Power System Check" on page 91.
POST does not complete. No beep or error codes are indicated.	"Power-On Self-Test (POST) Error Message" on page 92 "Undetermined Problems" on page 104
POST detects an error and displayed messages on screen.	"Error Message List" on page 94
Other symptoms (i.e. LCD display problems or others).	"Power-On Self-Test (POST) Error Message" on page 92
Symptoms cannot be re-created (intermittent problems).	Use the customer-reported symptoms and go to "Power-On Self-Test (POST) Error Message" on page 92 "Intermittent Problems" on page 104 "Undetermined Problems" on page 104

System Check Procedures

External Diskette Drive Check

Do the following to isolate the problem to a controller, driver, or diskette. A write-enabled, diagnostic diskette is required.

NOTE: Make sure that the diskette does not have more than one label attached to it. Multiple labels can cause damage to the drive or cause the drive to fail.

Do the following to select the test device.

1. Boot from the diagnostics diskette and start the diagnostics program.
2. See if FDD Test is passed as the program runs to FDD Test.
3. Follow the instructions in the message window.

If an error occurs with the internal diskette drive, reconnect the diskette connector on the system board.

If the error still remains:

1. Reconnect the external diskette drive/DVD-ROM module.
2. Replace the external diskette drive/CD-ROM module.
3. Replace the main board.

External Optical Disk Drive Check

Do the following to isolate the problem to a controller, drive, or optical disk drive. Make sure that the CD-ROM does not have any label attached to it. The label can cause damage to the drive or can cause the drive to fail.

Do the following to select the test device:

1. Boot from the diagnostics diskette and start the diagnostics program.
2. See if CD-ROM Test is passed when the program runs to CD-ROM Test.
3. Follow the instructions in the message window.

If an error occurs, reconnect the connector on the System board. If the error still remains:

1. Reconnect the external diskette drive/CD-ROM module.
2. Replace the external diskette drive/CD-ROM module.
3. Replace the main board.

Keyboard or Auxiliary Input Device Check

Remove the external keyboard if the internal keyboard is to be tested.

If the internal keyboard does not work or an unexpected character appears, make sure that the flexible cable extending from the keyboard is correctly seated in the connector on the system board.

If the keyboard cable connection is correct, run the Keyboard Test.

If the tests detect a keyboard problem, do the following one at a time to correct the problem. Do not replace a non-defective FRU:

1. Reconnect the keyboard cables.
2. Replace the keyboard.
3. Replace the main board.

The following auxiliary input devices are supported by this computer:

- Numeric keypad
- External keyboard

If any of these devices do not work, reconnect the cable connector and repeat the failing operation.

Memory Check

Memory errors might stop system operations, show error messages on the screen, or hang the system.

1. Boot from the diagnostics diskette and start the diagnostic program (please refer to main board).
2. Go to the diagnostic memory in the test items.
3. Press F2 in the test items.
4. Follow the instructions in the message window.

NOTE: Make sure that the DIMM is fully installed into the connector. A loose connection can cause an error.

Power System Check

To verify the symptom of the problem, power on the computer using each of the following power sources:

1. Remove the battery pack.
2. Connect the power adapter and check that power is supplied.
3. Disconnect the power adapter and install the charged battery pack; then check that power is supplied by the battery pack.

If you suspect a power problem, see the appropriate power supply check in the following list:

- “Check the Power Adapter” on page 91
- “Check the Battery Pack” on page 92

Check the Power Adapter

Unplug the power adapter cable from the computer and measure the output voltage at the plug of the power adapter cable. See the following figure

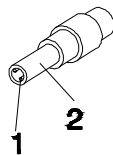

Pin 1: +19 to +20.5V

Pin 2: 0V, Ground

1. If the voltage is not correct, replace the power adapter.
2. If the voltage is within the range, do the following:
 - Replace the System board.
 - If the problem is not corrected, see “Undetermined Problems” on page 104.
 - If the voltage is not correct, go to the next step.

NOTE: An audible noise from the power adapter does not always indicate a defect.

3. If the power-on indicator does not light up, check the power cord of the power adapter for correct continuity and installation.
4. If the operational charge does not work, see “Check the Battery Pack” on page 92.

Check the Battery Pack

To check the battery pack, do the following:

From Software:

1. Check out the Power Management in control Panel.
2. In Power Meter, confirm that if the parameters shown in the screen for Current Power Source and Total Battery Power Remaining are correct.
3. Repeat the steps 1 and 2, for both battery and adapter.
4. This helps you identify first the problem is on recharging or discharging.

From Hardware:

1. Power off the computer.
2. Remove the battery pack and measure the voltage between battery terminals 1(+) and 6(ground).
3. If the voltage is still less than 7.5 Vdc after recharging, replace the battery.

To check the battery charge operation, use a discharged battery pack or a battery pack that has less than 50% of the total power remaining when installed in the computer.

If the battery status indicator does not light up, remove the battery pack and let it return to room temperature. Re-install the battery pack.

If the charge indicator still does not light up, replace the battery pack. If the charge indicator still does not light up, replace the DC/DC charger board.

Touchpad Check

If the touchpad doesn't work, do the following actions one at a time to correct the problem. Do not replace a non-defective FRU:

1. Reconnect the touchpad cables.
2. Replace the touchpad.
3. Replace the system board.

After you use the touchpad, the pointer drifts on the screen for a short time. This self-acting pointer movement can occur when a slight, steady pressure is applied to the touchpad pointer. This symptom is not a hardware problem. No service actions are necessary if the pointer movement stops in a short period of time.

Power-On Self-Test (POST) Error Message

The POST error message index lists the error message and their possible causes. The most likely cause is listed first.

NOTE: Perform the FRU replacement or actions in the sequence shown in FRU/Action column, if the FRU replacement does not solve the problem, put the original part back in the computer. Do not replace a non-defective FRU.

This index can also help you determine the next possible FRU to be replaced when servicing a computer.

If the symptom is not listed, see "Undetermined Problems" on page 104.

The following lists the error messages that the BIOS displays on the screen and the error symptoms classified by function.

NOTE: Most of the error messages occur during POST. Some of them display information about a hardware device, e.g., the amount of memory installed. Others may indicate a problem with a device, such as the way it has been configured.

NOTE: If the system fails after you make changes in the BIOS Setup Utility menus, reset the computer, enter Setup and install Setup defaults or correct the error.

Index of Error Messages

Error Code List

Error Codes	Error Messages
006	Equipment Configuration Error Causes: 1. CPU BIOS Update Code Mismatch 2. IDE Primary Channel Master Drive Error (The causes will be shown before "Equipment Configuration Error")
010	Memory Error at xxxx:xxx:xxxh (R:xxxh, W:xxxh)
070	Real Time Clock Error
071	CMOS Battery Bad
072	CMOS Checksum Error
110	System disabled. Incorrect password is specified.
<No error code>	Battery critical LOW In this situation BIOS will issue 4 short beeps then shut down system, no message will show.
<No error code>	Thermal critical High In this situation BIOS will shut down system, not show message.

Error Message List

Error Messages	FRU/Action in Sequence
Failure Fixed Disk	Reconnect hard disk drive connector. "Load Default Settings" in BIOS Setup Utility. Hard disk drive System board
Stuck Key	see "Keyboard or Auxiliary Input Device Check" on page 90.
Keyboard error	see "Keyboard or Auxiliary Input Device Check" on page 90.
Keyboard Controller Failed	see "Keyboard or Auxiliary Input Device Check" on page 90.
Keyboard locked - Unlock key switch	Unlock external keyboard
Monitor type does not match CMOS - Run Setup	Run "Load Default Settings" in BIOS Setup Utility.
Shadow RAM Failed at offset: nnnn	BIOS ROM System board
System RAM Failed at offset: nnnn	DIMM System board
Extended RAM Failed at offset: nnnn	DIMM System board
System battery is dead - Replace and run Setup	Replace RTC battery and Run BIOS Setup Utility to reconfigure system time, then reboot system.
System CMOS checksum bad - Default configuration used	RTC battery Run BIOS Setup Utility to reconfigure system time, then reboot system.
System timer error	RTC battery Run BIOS Setup Utility to reconfigure system time, then reboot system. System board
Real time clock error	RTC battery Run BIOS Setup Utility to reconfigure system time, then reboot system. System board
Previous boot incomplete - Default configuration used	Run "Load Default Settings" in BIOS Setup Utility. RTC battery System board
Memory size found by POST differed from CMOS	Run "Load Default Settings" in BIOS Setup Utility. DIMM System board
Diskette drive A error	Check the drive is defined with the proper diskette type in BIOS Setup Utility See "External Diskette Drive Check" on page 90.
Incorrect Drive A type - run SETUP	Check the drive is defined with the proper diskette type in BIOS Setup Utility
System cache error - Cache disabled	System board
CPU ID:	System board
DMA Test Failed	DIMM System board
Software NMI Failed	DIMM System board

Error Message List

Error Messages	FRU/Action in Sequence
Fail-Safe Timer NMI Failed	DIMM System board
Device Address Conflict	Run "Load Default Settings" in BIOS Setup Utility. RTC battery System board
Allocation Error for device	Run "Load Default Settings" in BIOS Setup Utility. RTC battery System board
Failing Bits: nnnn	DIMM BIOS ROM System board
Fixed Disk n	None
Invalid System Configuration Data	BIOS ROM System board
I/O device IRQ conflict	Run "Load Default Settings" in BIOS Setup Utility. RTC battery System board
Operating system not found	Enter Setup and see if fixed disk and drive A: are properly identified. Diskette drive Hard disk drive System board

Error Message List

No beep Error Messages	FRU/Action in Sequence
No beep, power-on indicator turns off and LCD is blank.	Power source (battery pack and power adapter). See "Power System Check" on page 91.. Ensure every connector is connected tightly and correctly. Reconnect the DIMM. LED board. System board.
No beep, power-on indicator turns on and LCD is blank.	Power source (battery pack and power adapter). See "Power System Check" on page 91.. Reconnect the LCD connector Hard disk drive LCD inverter ID LCD cable LCD Inverter LCD System board
No beep, power-on indicator turns on and LCD is blank. But you can see POST on an external CRT.	Reconnect the LCD connectors. LCD inverter ID LCD cable LCD inverter LCD System board

Error Message List

No beep Error Messages	FRU/Action in Sequence
No beep, power-on indicator turns on and a blinking cursor shown on LCD during POST.	Ensure every connector is connected tightly and correctly. System board
No beep during POST but system runs correctly.	Speaker System board

Phoenix BIOS Beep Codes

Code	Beeps	POST Routine Description
02h		Verify Real Mode
03h		Disable Non-Maskable Interrupt (NMI)
04h		Get CPU type
06h		Initialize system hardware
08h		Initialize chipset with initial POST values
09h		Set IN POST flag
0Ah		Initialize CPU registers
0Bh		Enable CPU cache
0Ch		Initialize caches to initial POST values
0Eh		Initialize I/O component
0Fh		Initialize the local bus IDE
10h		Initialize Power Management
11h		Load alternate registers with initial POST values
12h		Restore CPU control word during warm boot
13h		Initialize PCI Bus Mastering devices
14h		Initialize keyboard controller
16h	1-2-2-3	BIOS ROM checksum
17h		Initialize cache before memory autosize
18h		8254 timer initialization
1Ah		8237 DMA controller initialization
1Ch		Reset Programmable Interrupt Controller
20h	1-3-1-1	Test DRAM refresh
22h	1-3-1-3	Test 8742 Keyboard Controller
24h		Set ES segment register to 4 GB
26h		Enable A20 line
28h		Autosize DRAM
29h		Initialize POST Memory Manager
2Ah		Clear 215 KB base RAM
2Ch	1-3-4-1	RAM failure on address line xxxx
2Eh	1-3-4-3	RAM failure on data bits xxxx of low byte of memory bus
2Fh		Enable cache before system BIOS shadow
30h	1-4-1-1	RAM failure on data bits xxxx of high byte of memory bus
32h		Test CPU bus-clock frequency
33h		Initialize Phoenix Dispatch Manager
36h		Warm start shut down
38h		Shadow system BIOS ROM
3Ah		Autosize cache

Code	Beeps	POST Routine Description
3Ch		Advanced configuration of chipset registers
3Dh		Load alternate registers with CMOS values
42h		Initialize interrupt vectors
45h		POST device initialization
46h	2-1-2-3	Check ROM copyright notice
48h		Check video configuration against CMOS
49h		Initialize PCI bus and devices
4Ah		Initialize all video adapters in system
4Bh		QuietBoot start (optional)
4Ch		Shadow video BIOS ROM
4Eh		Display BIOS copyright notice
50h		Display CPU type and speed
51h		Initialize EISA board
52h		Test keyboard
54h		Set key click if enabled
58h	2-2-3-1	Test for unexpected interrupts
59h		Initialize POST display service
5Ah		Display prompt "Press F2 to enter SETUP"
5Bh		Disable CPU cache
5Ch		Test RAM between 512 and 640 KB
60h		Test extended memory
62h		Test extended memory address lines
64h		Jump to User Patch1
66h		Configure advanced cache registers
67h		Initialize Multi Processor APIC
68h		Enable external and CPU caches
69h		Setup System Management Mode (SMM) area
6Ah		Display external L2 cache size
6Bh		Load custom defaults (optional)
6Ch		Display shadow-area message
6Eh		Display possible high address for UMB recovery
70h		Display error messages
72h		Check for configuration errors
76h		Check for keyboard errors
7Ch		Set up hardware interrupt vectors
7Eh		Initialize coprocessor if present
80h		Disable onboard Super I/O ports and IRQs
81h		Late POST device initialization

Code	Beeps	POST Routine Description
82h		Detect and install external RS232 ports
83h		Configure non-MCD IDE controllers
84h		Detect and install external parallel ports
85h		Initialize PC-compatible PnP ISA devices
86h		Re-initialize onboard I/O ports
87h		Configure Motherboard Configurable Devices (optional)
88h		Initialize BIOS Area
89h		Enable Non-Maskable Interrupts (NMIs)
8Ah		Initialize Extended BIOS Data Area
8Bh		Test and initialize PS/2 mouse
8Ch		Initialize floppy controller
8Fh		Determine number of ATA drives (optional)
90h		Initialize hard-disk controllers
91h		Initialize local-bus hard-disk controllers
92h		Jump to UserPatch2
93h		Build MPTABLE for multi-processor boards
95h		Install CD ROM for boot
96h		Clear huge ES segment register
97h		Fixup Multi Processor table
98h	1-2	Search for option ROMs. One long, two short beeps on checksum failure.
99h		Check for SMART drive (optional)
9Ah		Shadow option ROMs
9Ch		Set up Power Management
9Dh		Initialize security engine (optional)
9Eh		Enable hardware interrupts
9Fh		Determine number of ATA and SCSI drives
A0h		Set time of day
A2h		Check key lock
A4h		Initialize Typematic rate
A8h		Erase F2 prompt
AAh		Scan for F2 key stroke
ACh		Enter SETUP
A Eh		Clear Boot flag
B0h		Check for errors
B2h		POST done- prepare to boot operating system
B4h	1	One short beep before boot
B5h		Terminate QuietBoot (optional)
B6h		Check password (optional)

Code	Beeps	POST Routine Description
B9h		Prepare Boot
BAh		Initialize DMI parameters
BBh		Initialize PnP Option ROMs
BCh		Clear parity checkers
BDh		Display MultiBoot menu
BEh		Clear screen (optional)
BFh		Check virus and backup reminders
C0h		Try to boot with INT 19
C1h		Initialize POST Error Manager (PEM)
C2h		Initialize error logging
C3h		Initialize error display function
C4h		Initialize system error handler
C5h		PnPnd dual CMOS (optional)
C6h		Initialize notebook docking (optional)
C7h		Initialize notebook docking late
C8h		Force check (optional)
C9h		Extended checksum (optional)
D2h		Unknown interrupt
E0h		Initialize the chipset
E1h		Initialize the bridge
E2h		Initialize the CPU
E3h		Initialize the system timer
E4h		Initialize system I/O
E5h		Check force recovery boot
E6h		Checksum BIOS ROM
E7h		Go to BIOS
E8h		Set Huge Segment
E9h		Initialize Multi Processor
EAh		Initialize OEM special code
EBh		Initialize PIC and DMA
ECh		Initialize Memory type
EDh		Initialize Memory size
EEh		Shadow Boot Block
EFh		System memory test
F0h		Initialize interrupt vectors
F1h		Initialize Run Time Clock
F2h		Initialize video
F3h		Initialize System Management Mode
F4h	1	Output one beep before boot
F5h		Boot to Mini DOS
F6h		Clear Huge Segment
F7h		Boot to Full DOS

Index of Symptom-to-FRU Error Message

LCD-Related Symptoms

Symptom / Error	Action in Sequence
LCD backlight doesn't work LCD is too dark LCD brightness cannot be adjusted LCD contrast cannot be adjusted	Enter BIOS Utility to execute "Load Setup Default Settings", then reboot system. Reconnect the LCD connectors. Keyboard (if contrast and brightness function key doesn't work). LCD inverter ID LCD cable LCD inverter LCD System board
Unreadable LCD screen Missing pels in characters Abnormal screen Wrong color displayed	Reconnect the LCD connector LCD inverter ID LCD cable LCD inverter LCD System board
LCD has extra horizontal or vertical lines displayed.	LCD inverter ID LCD inverter LCD cable LCD System board

Indicator-Related Symptoms

Symptom / Error	Action in Sequence
Indicator incorrectly remains off or on, but system runs correctly	Reconnect the inverter board Inverter board System board

Power-Related Symptoms

Symptom / Error	Action in Sequence
Power shuts down during operation	Power source (battery pack and power adapter). See "Power System Check" on page 91. Battery pack Power adapter Hard drive & battery connection board System board
The system doesn't power-on.	Power source (battery pack and power adapter). See "Power System Check" on page 91. Battery pack Power adapter Hard drive & battery connection board System board

Power-Related Symptoms

Symptom / Error	Action in Sequence
The system doesn't power-off.	Power source (battery pack and power adapter). See "Power System Check" on page 91. Hold and press the power switch for more than 4 seconds. System board
Battery can't be charged	See "Check the Battery Pack" on page 92. Battery pack System board

PCMCIA-Related Symptoms

Symptom / Error	Action in Sequence
System cannot detect the PC Card (PCMCIA)	PCMCIA slot assembly System board
PCMCIA slot pin is damaged.	PCMCIA slot assembly

Memory-Related Symptoms

Symptom / Error	Action in Sequence
Memory count (size) appears different from actual size.	Enter BIOS Setup Utility to execute "Load Default Settings, then reboot system. DIMM System board

Speaker-Related Symptoms

Symptom / Error	Action in Sequence
In Windows, multimedia programs, no sound comes from the computer.	Audio driver Speaker System board
Internal speakers make noise or emit no sound.	Speaker System board

Power Management-Related Symptoms

Symptom / Error	Action in Sequence
The system will not enter hibernation	See "Save to Disk (S4)" on page 21. Keyboard (if control is from the keyboard) Hard disk drive System board
The system doesn't enter hibernation mode and four short beeps every minute.	Press Fn+ O and see if the computer enters hibernation mode. Touchpad Keyboard Hard disk connection board Hard disk drive System board
The system doesn't enter standby mode after closing the LCD	See "Save to Disk (S4)" on page 21. LCD cover switch System board

Power Management-Related Symptoms

Symptom / Error	Action in Sequence
The system doesn't resume from hibernation mode.	See "Save to Disk (S4)" on page 21. Hard disk connection board Hard disk drive System board
The system doesn't resume from standby mode after opening the LCD.	See "Save to Disk (S4)" on page 21. LCD cover switch System board
Battery fuel gauge in Windows doesn't go higher than 90%.	Remove battery pack and let it cool for 2 hours. Refresh battery (continue use battery until power off, then charge battery). Battery pack System board
System hangs intermittently.	Reconnect hard disk/CD-ROM drives. Hard disk connection board System board

Peripheral-Related Symptoms

Symptom / Error	Action in Sequence
System configuration does not match the installed devices.	Enter BIOS Setup Utility to execute "Load Default Settings", then reboot system. Reconnect hard disk/CD-ROM/diskette drives.
External display does not work correctly.	Press Fn+F5, LCD/CRT/Both display switching System board
USB does not work correctly	System board
Print problems.	Onboard Devices Configuration Run printer self-test. Printer driver Printer cable Printer System Board
Serial or parallel port device problems.	Device driver Device cable Device System board

Keyboard/Touchpad-Related Symptoms

Symptom / Error	Action in Sequence
Keyboard (one or more keys) does not work.	Reconnect the keyboard cable. Keyboard System board
Touchpad does not work.	Reconnect touchpad cable. Touchpad board System board

Modem-Related Symptoms

Symptom / Error	Action in Sequence
Internal modem does not work correctly.	Modem phone port modem combo board System board

NOTE: If you cannot find a symptom or an error in this list and the problem remains, see “Undetermined Problems” on page 104.

Intermittent Problems

Intermittent system hang problems can be caused by a variety of reasons that have nothing to do with a hardware defect, such as: cosmic radiation, electrostatic discharge, or software errors. FRU replacement should be considered only when a recurring problem exists.

When analyzing an intermittent problem, do the following:

1. Run the advanced diagnostic test for the system board in loop mode at least 10 times.
2. If no error is detected, do not replace any FRU.
3. If any error is detected, replace the FRU. Rerun the test to verify that there are no more errors.

Undetermined Problems

The diagnostic problems does not identify which adapter or device failed, which installed devices are incorrect, whether a short circuit is suspected, or whether the system is inoperative.

Follow these procedures to isolate the failing FRU (do not isolate non-defective FRU).

NOTE: Verify that all attached devices are supported by the computer.

NOTE: Verify that the power supply being used at the time of the failure is operating correctly. (See “Power System Check” on page 91.):

1. Power-off the computer.
2. Visually check them for damage. If any problems are found, replace the FRU.
3. Remove or disconnect all of the following devices:
 - Non-Acer devices
 - Printer, mouse, and other external devices
 - Battery pack
 - Hard disk drive
 - DIMM
 - CD-ROM/Diskette drive Module
 - PC Cards
4. Power-on the computer.
5. Determine if the problem has changed.
6. If the problem does not recur, reconnect the removed devices one at a time until you find the failing FRU.
7. If the problem remains, replace the following FRU one at a time. Do not replace a non-defective FRU:
 - System board
 - LCD assembly

Connector Locations

Main Board

Top View

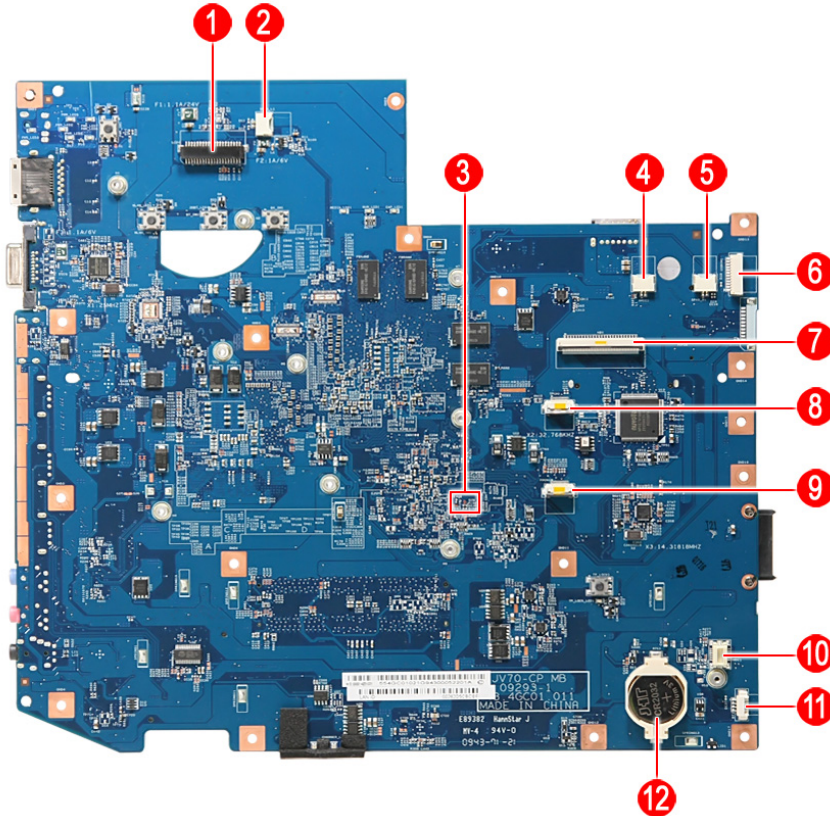

No.	Code	Connector
1	LCD1	LCD cable connector
2	SPKR_L1	Left speaker cable connector
3	G29	Hardware gap
4	AMIC1	Microphone cable connector
5	SPKR_R1	Right speaker cable connector
6	USBCN1	USB cable connector
7	KB1	Keyboard cable connector
8	TPCN1	Touchpad cable connector
9	FPCN1	Touchpad button connector
10	MDC1	Modem board connector
11	BT1	Bluetooth cable connector
12	RTC1	RTC battery socket

Bottom View

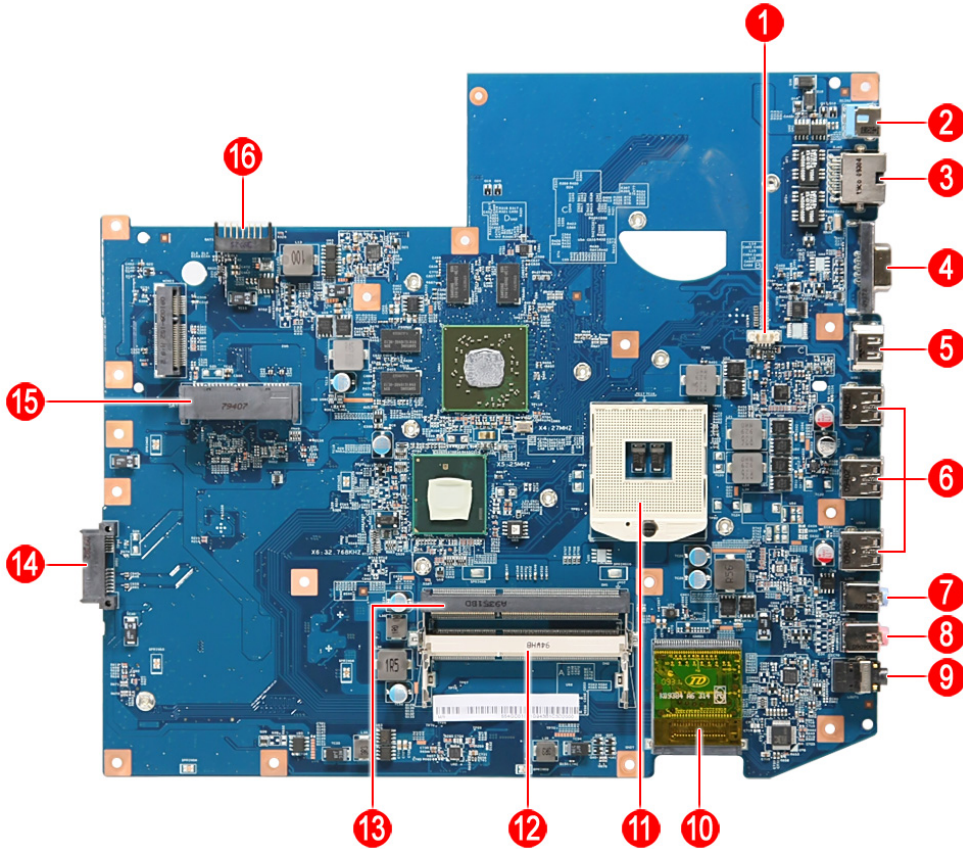

No.	Code	Connector
1	FAN1	Heatsink fan cable connector
2	DCIN1	DC-in cable connector
3	RJ45	Ethernet port
4	CRT1	VGA port
5	HDMI1	HDMI port
6	USB1 to USB3	USB 2.0 ports
7	LIN1	Line-in port
8	MICIN1	Microphone-in jack
9	LOUT1	Headphones/speaker/line-out jack with S/PDIF support
10	CARD1	SD card slot
11	CPU1	CPU socket
12	DM2	DIMM slot 2
13	DM1	DIMM slot 1
14	ODD1	Optical disk drive connector
15	SATATA1	HDD1 connector
16	BAT1	Main battery connector

Clearing Password Check and BIOS Recovery

This section provides the standard operating procedures for clearing the password and BIOS recovery for Aspire 7740/7740G Series. There is one Hardware Open Gap on the main board for clearing the password check and one Hotkey for enabling BIOS Recovery.

Clearing Password Check

Hardware Open Gap Description

Hardware	Default Setting	Operation Description
Gap	Open (Normal)	Short (Clearing Password Check)

HW Gap position on the main board:

Gap name in Aspire 7740/7740G Series is **G29**.

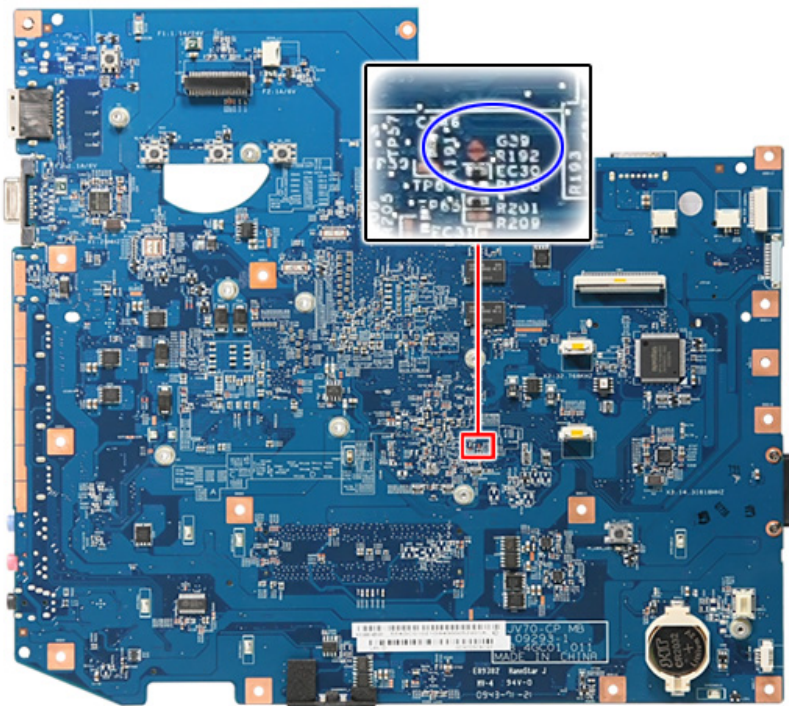

Steps for Clearing BIOS Password Check

If the user sets the BIOS Password (Supervisor Password and/or User Password) for a security reason, the BIOS will ask for the password during system POST or when the system enters into the BIOS Setup menu. If it is necessary to bypass the password check, the user needs to short the hardware gap to clear the password by following these steps:

- Power off the system, and remove the HDD, AC adapter and battery from the computer.
- Open the back cover of the computer and look for the hardware gap on the main board as shown in the picture(s) above.
- Use an electric conductivity tool to short the two points of the hardware gap.
- Plug in the AC adapter while retaining the short condition on the hardware gap. Press the power button to turn on the computer until the BIOS POST routine is finished. Finally, remove the tool from the hardware gap.
- Restart the system. Press the F2 key to enter BIOS Setup menu.

-
- If there is no password request, the BIOS Password is cleared. Otherwise, repeat the steps above and try again.

NOTE: The steps are only for clearing the BIOS password (Supervisor Password and User Password).

BIOS Recovery by Crisis Disk

BIOS Recovery Boot Block:

BIOS Recovery Boot Block is a special block of the BIOS. It is used to boot up the system with minimum BIOS initialization. Users can enable this feature to restore the BIOS firmware to a successful one once the previous BIOS flashing process failed.

BIOS Recovery Hotkey

The system provides a function hotkey: **Fn+Esc**, for enabling the BIOS Recovery process at system power-on during BIOS POST. To use this function, the AC adapter and the battery must be connected. If this function is enabled, the system will force the BIOS to enter a special BIOS block called Boot Block.

Steps for BIOS Recovery by Crisis Disk

Before doing this, prepare a Crisis Disk (refer to the “Steps for Creating the Crisis Disk in Windows” section below) and keep it ready in hand.

Follow these steps for BIOS recovery:

1. Power off the system.
2. Connect a removable USB storage device containing the Crisis Disk to a USB port connected to the BIOS flash failed system.
3. Under power-off state, press and hold **Fn+Esc** and then press the power button. The system should be powered on with the Crisis BIOS Recovery process.
4. BIOS Boot Block starts to restore the BIOS code from the Crisis Disk to BIOS ROM on the failed system.
5. After the crisis flashing process is finished, the system will restart.

After the Crisis Recovery process is finished, the system should have a successful and workable BIOS after power on. The user can then update the latest BIOS version for this system using the regular BIOS flashing process.

Creating the Crisis Disk in Windows

Follow these steps to create the Crisis Disk:

1. Prepare a removable USB storage device (size greater than 10MB). Note that all data on the USB storage device will be cleared during the creation of the Crisis Disk.
2. Set up another computer loaded with Windows operating system.

- Decompress the Crisis Package Source. Select **WINCRIS.EXE** and then select **Run as administrator** under Vista.

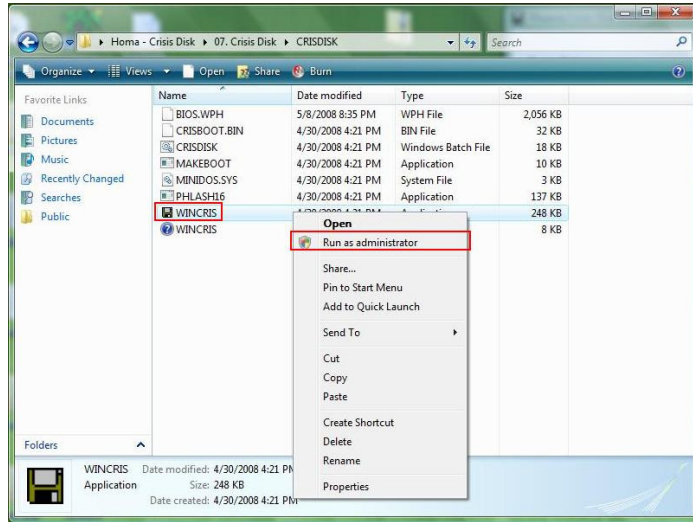

- Keep the default settings and then click on the **Start** button.

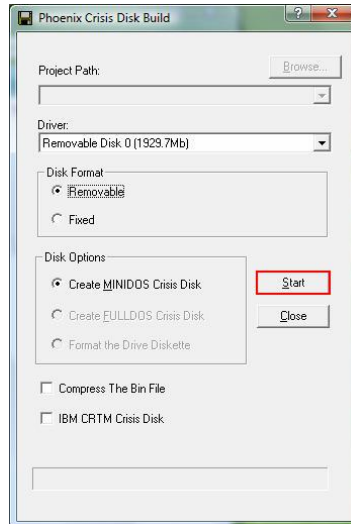

- When the pop-up warning dialog box appears, press **OK** to continue creating the Crisis Disk.

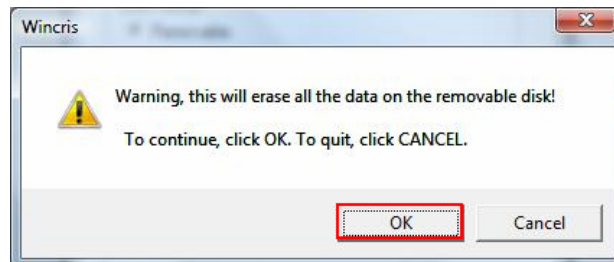

6. The Crisis Disk will be created after a few seconds.

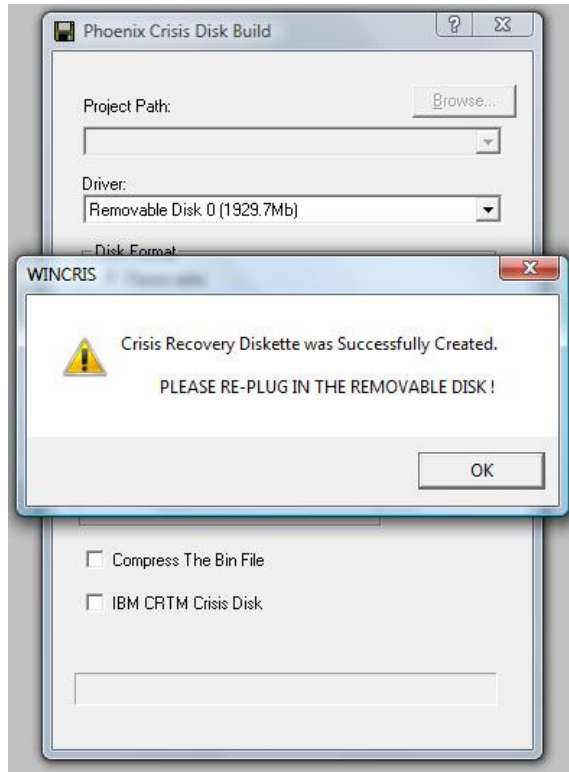

7. Press No if you do not want to create another Crisis Disk.

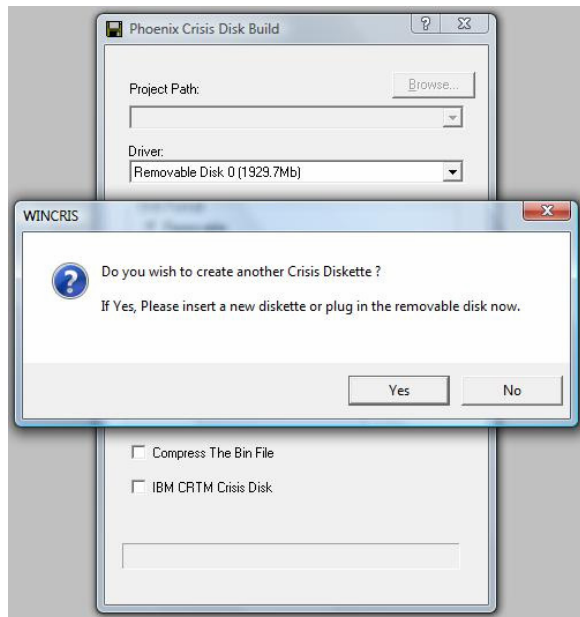

8. Reconnect the USB removable storage device and check if it contains the 3 files shown in the following figure.

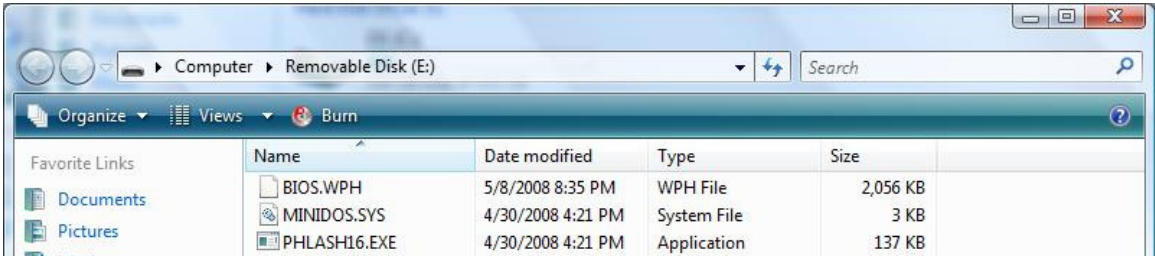

FRU (Field Replaceable Unit) List

This chapter gives you the FRU (Field Replaceable Unit) listing in global configurations of Aspire 7740/7740G Series. Refer to this chapter whenever ordering for parts to repair or for RMA (Return Merchandise Authorization).

Please note that WHEN ORDERING FRU PARTS, you should check the most up-to-date information available on your regional web or channel. For whatever reasons a part number change is made, it will not be noted on the printed Service Guide. For ACER AUTHORIZED SERVICE PROVIDERS, your Acer office may have a DIFFERENT part number code from those given in the FRU list of this printed Service Guide. You MUST use the local FRU list provided by your regional Acer office to order FRU parts for repair and service of customer machines.

NOTE: To scrap or to return the defective parts, you should follow the local government ordinance or regulations on how to dispose it properly, or follow the rules set by your regional Acer office on how to return it.

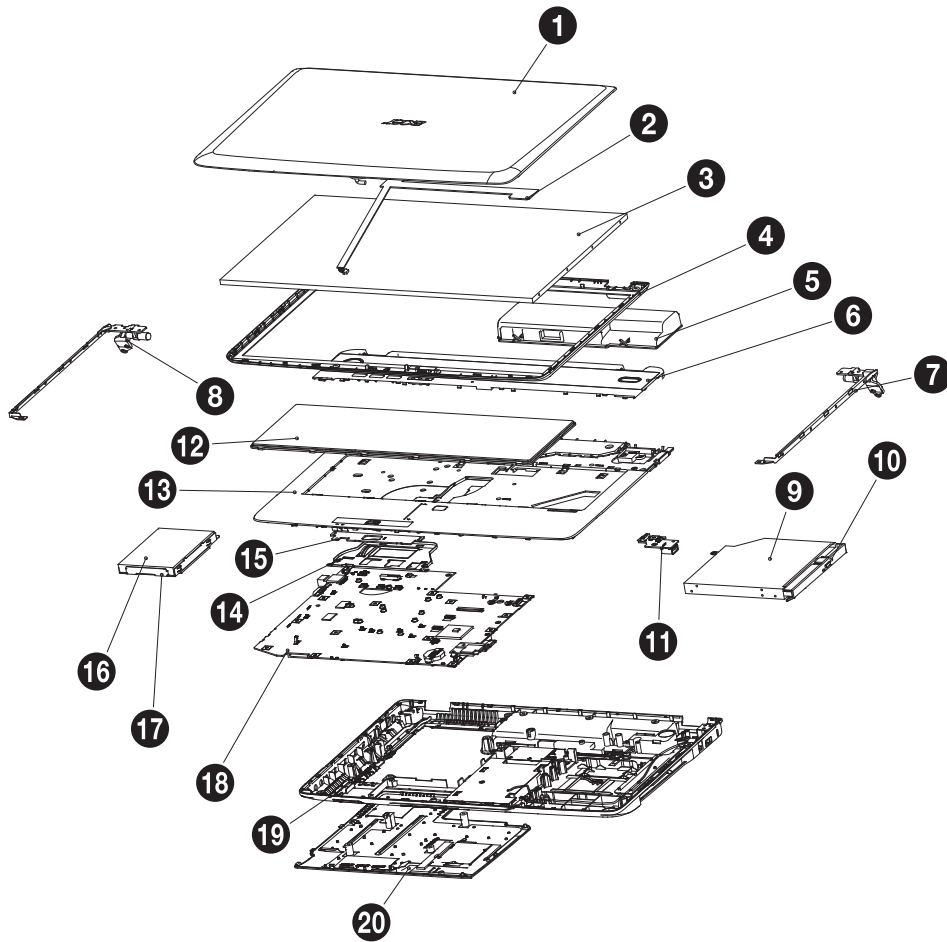

Exploded Diagram









NO	P/N	DESCRIPTION
1	60.4FX02.001	ASSY 60 LCD panel JV71
2	50.4FX01.001	C.A. lcd JV71
3	LK.17308.001	LED LCD LPL 17.3" WXGA+ Glare
4	60.4FX01.001	ASSY 60 LCD bezel JV71
5	BT.00803.024	Battery SANYO AS-2007B
6	60.4FX08.001	ASSY 60 mid cover JV71
7	34.4FX02.001	Hinge left assy JV71
8	34.4FX01.001	Hinge Right assy JV71
9	KU.00801.035	ODD TOSHIBA Super-Multi
10	60.4FX14.001	ASSY 60 ODD bezel JV71
11	55.4FX02.001G	USB BOARD JV71
12	9J.N1H82.A1D	Keyboard ACER AC7T
13	60.4FX05.001	ASSY 60 Finger Ucase JV71
14	60.4FX04.001	ASSY 60 tp brkt JV7
15	TBD	Finger print board
16	TBD	HDD
17	60.4CG08.002	HDD BRKT ASSY
18	TBD	M/B JV71
19	60.4FX12.001	ASSY 60 LCASE JV71
20	60.4FX13.001	ASSY 60 Big door JV71



Aspire 7740/7740G Series FRU List

1. ACER_ASPIRE 7740 UMACBK_JV70_CP (NO: LX.PLY02.025/44)

Category	No.	Part Name	Acer Part No.
	1	ADAPTER 65W 19V 3PIN DELTA ADP-65JH DB A LV5 LED LF YELLOW	AP.06501.026
	1	ADAPTER 65W 19V 3PIN LITEON PA-1650-22AC LV5 LED LF YELLOW	AP.06503.024
	1	ADAPTER 65W 19V 3PIN HIPRO HP-A0652R3B 1LF LV5 LED LF YELLOW	AP.0650A.012
	1	BATTERY SANYO AS-2007B LI-ION 3S2P SANYO 6 CELL 4400MAH MAIN COMMON NORMAL TYPE	BT.00603.042
	1	BATTERY SONY AS-2007B LI-ION 3S2P SONY 6 CELL 4400MAH MAIN COMMON NORMAL TYPE	BT.00604.025
	1	BATTERY PANASONIC AS-2007B LI-ION 3S2P PANASONIC 6 CELL 4400MAH MAIN COMMON PSS	BT.00605.021
	1	BATTERY SIMPLO AS-2007B LI-ION 3S2P SAMSUNG 6 CELL 4400MAH MAIN COMMON SDI 2.2F	BT.00606.001
	1	BATTERY SANYO AS-2007B LI-ION 4S2P SANYO 8 CELL 4800MAH MAIN COMMON	BT.00803.024
	1	BATTERY SONY AS-2007B LI-ION 4S2P SONY 8 CELL 4800MAH MAIN COMMON	BT.00804.020
	1	BLUETOOTH BOARD FOXCONN BRM 2046 BT2.1 T60H928.33 F/W:861	BH.21100.004
	1	BLUETOOTH BOARD FOXCONN ATHEROS AR3011 T77H056.01	54.03346.261
	2	MODEM BOARD FOXCONN DELPHI-AM5 V2H 1.5_3.3V AUS T60M951.36	FX.22500.023
	1	TOUCHPAD BUTTON BOARD	55.4GC03.001G
	1	TOUCHPAD BOARD SYNAPTICS TM00540-005	56.ATR01.001
	1	TOUCHPAD BOARD ALPS KGDF0038A	56.PAW01.001
	1	USB BOARD	55.4GC02.001G

Category	No.	Part Name	Acer Part No.
	1	WIRELESS LAN BOARD 112BN.HMWG INTEL MM#903341 INT1000H CONDOR PEAK 1X2 BGN HMC	KI.CPH01.001
	1	WIRELESS LAN BOARD INTEL 903531 INT1000HBG 1X2 HMC ABG FOR RUSSIA	KI.CPH01.002
	1	WIRELESS LAN BOARD INTEL 622AN.HMWG 903690 802.11 2X2AGN CENTRINO ADVANCED-N 6200	KI.PPH01.002
	1	WIRELESS LAN BOARD QMI ATHEROS HB93 1X2 BGN HM EM306	NI.23600.054
	1	WIRELESS LAN BOARD FOXCONN ATHEROS XB63 MINICARD B/G	NI.23600.046
	1	WIRELESS LAN BOARD 802.11BG FOXCONN T77H121.01 ATHEROS AR9285(HB95)	NI.23600.047
CABLES			
	1	BLUETOOTH BOARD CABLE	50.PJA01.004
	1	FINGER PRINT / TP BUTTON BAORD CABLE	50.PJA01.001
	2	LED LCD/CAMERA CABLE	50.4GC01.001
	2	MODEM CABLE	50.4FX06.001
	1	POWER CORD 10A 250V ARGENTINE	27.01518.0U1
	1	POWER CORD 10A 125V US	27.T30V1.001
	1	POWER CORD 10A 125V 3PIN US BK	27.01518.641
	1	POWER CORD 7A 250V 2PIN KOREAN	27.01518.531
	1	POWER CORD 3A 250V 3PIN UK	27.01518.541
	1	POWER CORD 5A 250V 3PIN UK BK	27.03118.001
	1	POWER CORD 7A 125V 2PIN JAPAN	27.01518.551
	1	POWER CORD 10A 3PIN BK DENMARK	27.01518.561
	1	POWER CORD 10A 250V 3PIN DENMARK BK	27.01518.671
	1	POWER CORD 10A 250V 3PIN BK SOUTH AFRICA	27.01518.571
	1	POWER CORD 16A 250V SOUTH AFRICA BK	27.01518.681
	1	POWER CORD 10A 250V SWISS	27.01518.581
	1	POWER CORD 10A 250V 3PIN SWISS BK	27.01518.691
	1	POWER CORD 10A 250V 3PIN CHINA	27.01518.591
	1	POWER CORD 10A 250V 3PIN CHINA BK	27.01518.701
	1	POWER CORD 250V 3PIN EUR BK	27.T30V1.004
	1	POWER CABLE 16A 250V 3PIN EUR BK	27.01518.731
	1	POWER CORD 10A 250V 3PIN ITALY	27.01518.611
	1	POWER CORD 10A 250V 3PIN ITALY BK	27.01518.711
	1	POWER CORD 2.5A 250V AUSTRALIA	27.01518.621
	1	POWER CORD 2.5A 250V SOUTH AFRICA BK (INDIA)	27.01518.631
	1	POWER CORD 10A 250V SOUTH AFRICA BK (INDIA)	27.01518.721
	1	POWER CORD 7A 125V 2PIN JAPAN BK	27.01518.661
	1	POWER CORD 250V 10A 3PIN ISRAEL	27.01518.761
1	POWER CORD 2.5A 125V USA	27.01518.781	
1	POWER CORD 2.5A 125V 1.8M BLACK TAIWANESE	27.01518.A11	

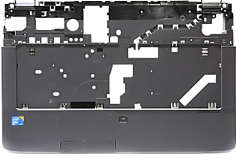
Category	No.	Part Name	Acer Part No.
CABLES	1	POWER CORD 10A 250V 1.8M BRAZIL BLK	27.01518.A41
	1	POWER CORD ACA / ACNZ	27.03218.021
	1	POWER CORD 7.5A 250V 3P AUSTRALIA BK	27.03218.051
	1	POWER CODE 7A 125V 2PIN JAPAN	27.03518.161
	1	TOUCHPAD CABLE	50.PJA01.003
	1	TOUCHPAD CABLE	50.PJA01.003
	1	USB BOARD CABLE	50.PJA01.002
	1	USB BOARD CABLE	50.PJA01.002
	1	USB BOARD CABLE	50.PJA01.002
CAMERA 	2	CAMERA 0.3M SUYIN CN0314-SN30-OV03-5	57.N4401.001
	2	CAMERA 0.3M CHICONY CNF701721004973L	57.W9401.001
	2	CAMERA 0.3M CHICONY CNF804621004970LH CALLA_2GA	56.18007.095
CASE/COVER/BRACKET ASSEMBLY	2	BLUE-RAY COMBO BEZEL	42.PJA01.004
	2	DVD-RW SUPER-MULTI BEZEL	42.PJA01.003
	2	HDD BRACKET	33.PAW01.003
	2	LED LCD BRACKET LEFT W/HINGE	33.PJA01.002
	2	LED LCD BRACKET RIGHT W/HINGE	33.PJA01.003
	2	LED LCD BEZEL 17.3" W/CAMERA HOLE	60.PJA01.004
	2	LED LCD COVER 17.3" IMR BLUE W/ANTENNA*2 & LOGO	60.PJA01.005
	1	LOWER CASE W/MODEM CABLE & MICROPHONE & SPEAKER	60.PJA01.001
	1	MIDDLE COVER	42.PJA01.001
	2	OPTICAL BRACKET	33.PAW01.002
	1	SD DUMMY CARD	42.TKJ01.001





Category	No.	Part Name	Acer Part No.
	1	TOUCHPAD BRACKET	33.PJA01.001
	1	UNITLOAD COVER	42.PJA01.002
	1	UPPER CASE BLACK W/SPEAKER W/O FINGER PRINT HOLE	60.PJA01.002
COMBO MODULE	1	BLU-RAY COMBO MODULE 4X SATA WINDOWS7	
	2	ODD PIONEER BD COMBO 12.7MM TRAY DL 4X SATA BDC-TD01RS LF W/O BEZEL FOR WINDOWS7	KO.00405.003
	2	ODD SONY BD COMBO 12.7MM TRAY DL 4X BC-5500S LF W/O BEZEL FW 1.E1 SATA FOR WINDOWS7	KO.0040E.002
	2	ODD PLDS BD COMBO 12.7MM TRAY DL 4X DS-4E1S LF W/O BEZEL SATA FOR WINDOWS7	KO.0040F.003
	1	CPU INTEL CORE I3 330M PGA 2.13G 35W ARRANDALE TJ90 VT 3M L3	KC.33001.DMP
	1	CPU INTEL CORE I3 350M PGA 2.26G 35W ARRANDALE TJ90 VT 3M L3	KC.35001.DMP
	1	CPU INTEL CORE I5 430M PGA 2.26G ARR UP TO SC 2.53G ARRANDALE 3M L3	KC.43001.DMP
	1	CPU INTEL CORE I5 520M 2.4G 35W ARRANDALE 3M	KC.52001.DMP
	1	CPU INTEL CORE I5 540M 2.53G ARRANDALE 3M	KC.54001.DMP
	1	CPU INTEL CORE I7 620M PGA 2.66G ARRANDALE 4M	KC.62001.DMP
DVD-RW DRIVE	1	DVD-RW SUPER-MULTI MODULE 8X SATA WINDOWS7	
	2	ODD HLDS SUPER-MULTI DRIVE 12.7MM TRAY DL 8X GT30N LF W/O BEZEL SATA FOR HF+WINDOWS7	KU.0080D.048
	2	ODD TOSHIBA SUPER-MULTI DRIVE 12.7MM TRAY DL 8X TS-L633C LF W/O BEZEL SATA FOR HF+WINDOWS7	KU.00801.035
	2	ODD SONY SUPER-MULTI DRIVE 12.7MM TRAY DL 8X AD-7585H LF W/O BEZEL SATA FOR HF+WINDOWS7	KU.0080E.027
	2	ODD PLDS SUPER-MULTI DRIVE 12.7MM TRAY DL 8X DS-8A4SH LF W/O BEZEL SATA FOR HF+WINDOWS7	KU.0080F.006
	HDD/HARD DISK DRIVE	1	HDD MODULE 160GB 5400RPM SATA
	2	HDD 160GB 5400RPM 2.5" SATA WYATT SEAGATE ST9160314AS F/W:0001SDM1	KH.16001.042
	2	HDD 160GB 5400RPM SATA TOSHIBA LIBRA-BS MK1655GSX F/W:FG0101J 5.4	KH.16004.006



Category	No.	Part Name	Acer Part No.
HDD/HARD DISK DRIVE	2	HDD 160GB 5400RPM SATA HGST PANTHER-B PANTHER-B HTS545016B9A300 F/W:C60F	KH.16007.024
	2	HDD 160GB 5400RPM 2.5" SATA WD WD1600BEVT-22ZCT0 F/W:11.01A11	KH.16008.022
	1	HDD MODULE 250GB 5400RPM SATA	
	2	HDD 2.5" 5400RPM 250GB SEAGATE ST9250315AS WYATT SATA LF F/W:0001SDM1	KH.25001.016
	2	HDD 250GB 5400RPM SATA TOSHIBA LIBRA-BS MK2555GSX F/W:FG000J 5.4K	KH.25004.003
	2	HDD 250GB 5400RPM SATA HGST HTS545025B9A300 PANTHER-B LF	KH.25007.015
	2	HDD 250GB 5400RPM 2.5" SATA HGST HTS545025B9A300 PANTHER B LF F/W:C60F DISK IMBALANCE CRITERIA = 0.014G-CM	KH.25007.016
	2	HDD 250GB 5400RPM SATA WD WD2500BEVT-22ZCT0 F/W:11.01A11	KH.25008.021
	1	HDD MODULE 320GB 5400RPM SATA	
	2	HDD 320GB 5400RPM 2.5" SATA HGST HTS545032B9A300 PANTHER B LF F/W:C60F DISK IMBALANCE CRITERIA = 0.014G-CM	KH.32007.008
	2	HDD 320GB 5400RPM SATA SEAGATE WYATT ST9320325AS FW:0001SDM1	KH.32001.017
	2	HDD 320GB 5400RPM SATA TOSHIBA MK3255GSX LIBRA LF F/W:FG010J	KH.32004.002
	2	HDD 320GB 5400RPM SATA HGST HTS545032B9A300 PANTHER B LF	KH.32007.007
	2	HDD 320GB 5400RPM SATA WD WD3200BEVT-22ZCT0 ML125 F/W:01.01A01	KH.32008.013
	1	HDD MODULE 500GB 5400RPM SATA	
	2	HDD 500GB 5400RPM SEAGATE ST9500325AS SATA LF F/W:0001SDM1	KH.50001.011
	2	HDD 2.5" 5400RPM 500GB TOSHIBA MK5055GSX LIBRA SATA LF F/W:FG001J	KH.50004.001
	2	HDD 500GB 5400RPM HGST SATA HTS545050B9A300 PANTHER B LF	KH.50007.009
	2	HDD HGST 2.5" 5400RPM 500GB HTS545050B9A300 PANTHER B SATA LF F/W:C60F DISK IMBALANCE CRITERIA = 0.014G-CM	KH.50007.010
	2	HDD 500GB 5400RPM WD SATA WD5000BEVT-22ZAT0 F/W:01.01A01	KH.50008.013
	1	HDD MODULE 640GB 5400RPM SATA	
	2	HDD 640GB 5400RPM 2.5" SATA WD ML320 WD6400BEVT-22A0RT0 F/W:01.01A01 5.4	KH.64008.004
HEATSINK	1	CPU HEATSINK UMA W/FAN	60.4GC03.001
	1	CPU HEATSINK UMA W/FAN	60.4GC04.001

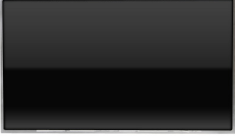

Category	No.	Part Name	Acer Part No.
KEYBOARD 	1	KEYBOARD 104KEYS NSK-ALA0J AC7T JV50 INTERNAL 17 STANDARD BLACK TEXTURE GERMAN	KB.I170A.040
	1	KEYBOARD 104KEYS NSK-ALA0J AC7T JV50 INTERNAL 17 STANDARD BLACK TEXTURE GERMAN	KB.I170A.040
	1	KEYBOARD 104KEYS NSK-ALA0J AC7T JV50 INTERNAL 17 STANDARD BLACK TEXTURE SWISS	KB.I170A.052
	1	KEYBOARD 104KEYS NSK-ALA0J AC7T JV50 INTERNAL 17 STANDARD BLACK TEXTURE SWISS	KB.I170A.052
	1	KEYBOARD 103KEYS NSK-ALA0J AC7T JV50 INTERNAL 17 STANDARD BLACK TEXTURE TAIWAN	KB.I170A.036
	1	KEYBOARD 103KEYS NSK-ALA0J AC7T JV50 INTERNAL 17 STANDARD BLACK TEXTURE TAIWAN	KB.I170A.036
	1	KEYBOARD 103KEYS NSK-ALA0J AC7T JV50 INTERNAL 17 STANDARD BLACK TEXTURE THAILAND	KB.I170A.053
	1	KEYBOARD 103KEYS NSK-ALA0J AC7T JV50 INTERNAL 17 STANDARD BLACK TEXTURE THAILAND	KB.I170A.053
	1	KEYBOARD 104KEYS NSK-ALA0J AC7T JV50 INTERNAL 17 STANDARD BLACK TEXTURE PORTUGAL	KB.I170A.047
	1	KEYBOARD 104KEYS NSK-ALA0J AC7T JV50 INTERNAL 17 STANDARD BLACK TEXTURE PORTUGAL	KB.I170A.047
	1	KEYBOARD 103KEYS NSK-ALA0J AC7T JV50 INTERNAL 17 STANDARD BLACK TEXTURE ARABIC	KB.I170A.032
	1	KEYBOARD 103KEYS NSK-ALA0J AC7T JV50 INTERNAL 17 STANDARD BLACK TEXTURE ARABIC	KB.I170A.032
	1	KEYBOARD 104KEYS NSK-ALA0J AC7T JV50 INTERNAL 17 STANDARD BLACK TEXTURE DANISH	KB.I170A.037
	1	KEYBOARD 104KEYS NSK-ALA0J AC7T JV50 INTERNAL 17 STANDARD BLACK TEXTURE DANISH	KB.I170A.037
	1	KEYBOARD 104KEYS NSK-ALA0J AC7T JV50 INTERNAL 17 STANDARD BLACK TEXTURE ITALIAN	KB.I170A.043
	1	KEYBOARD 104KEYS NSK-ALA0J AC7T JV50 INTERNAL 17 STANDARD BLACK TEXTURE ITALIAN	KB.I170A.043
	1	KEYBOARD 104KEYS NSK-ALA0J AC7T JV50 INTERNAL 17 STANDARD BLACK TEXTURE FRENCH	KB.I170A.039
	1	KEYBOARD 104KEYS NSK-ALA0J AC7T JV50 INTERNAL 17 STANDARD BLACK TEXTURE FRENCH	KB.I170A.039
	1	KEYBOARD 103KEYS NSK-ALA0J AC7T JV50 INTERNAL 17 STANDARD BLACK TEXTURE HEBREW	KB.I170A.057
	1	KEYBOARD 103KEYS NSK-ALA0J AC7T JV50 INTERNAL 17 STANDARD BLACK TEXTURE HEBREW	KB.I170A.057
	1	KEYBOARD 107KEYS NSK-ALA0J AC7T JV50 INTERNAL 17 STANDARD BLACK TEXTURE JAPANESE	KB.I170A.044
	1	KEYBOARD 107KEYS NSK-ALA0J AC7T JV50 INTERNAL 17 STANDARD BLACK TEXTURE JAPANESE	KB.I170A.044
	1	KEYBOARD 103KEYS NSK-ALA0J AC7T JV50 INTERNAL 17 STANDARD BLACK TEXTURE GREEK	KB.I170A.041
	1	KEYBOARD 103KEYS NSK-ALA0J AC7T JV50 INTERNAL 17 STANDARD BLACK TEXTURE GREEK	KB.I170A.041
	1	KEYBOARD 104KEYS NSK-ALA0J AC7T JV50 INTERNAL 17 STANDARD BLACK TEXTURE NORWEGIAN	KB.I170A.046
	1	KEYBOARD 104KEYS NSK-ALA0J AC7T JV50 INTERNAL 17 STANDARD BLACK TEXTURE NORWEGIAN	KB.I170A.046
	1	KEYBOARD 104KEYS NSK-ALA0J AC7T JV50 INTERNAL 17 STANDARD BLACK TEXTURE HUNGARIAN	KB.I170A.042

Category	No.	Part Name	Acer Part No.
KEYBOARD	1	KEYBOARD 104KEYS NSK-ALA0J AC7T JV50 INTERNAL 17 STANDARD BLACK TEXTURE HUNGARIAN	KB.I170A.042
	1	KEYBOARD 103KEYS NSK-ALA0J AC7T JV50 INTERNAL 17 STANDARD BLACK TEXTURE RUSSIAN	KB.I170A.048
	1	KEYBOARD 103KEYS NSK-ALA0J AC7T JV50 INTERNAL 17 STANDARD BLACK TEXTURE RUSSIAN	KB.I170A.048
	1	KEYBOARD 104KEYS NSK-ALA0J AC7T JV50 INTERNAL 17 STANDARD BLACK TEXTURE SPANISH	KB.I170A.050
	1	KEYBOARD 104KEYS NSK-ALA0J AC7T JV50 INTERNAL 17 STANDARD BLACK TEXTURE SPANISH	KB.I170A.050
	1	KEYBOARD 104KEYS NSK-ALA0J AC7T JV50 INTERNAL 17 STANDARD BLACK TEXTURE TURKISH	KB.I170A.054
	1	KEYBOARD 104KEYS NSK-ALA0J AC7T JV50 INTERNAL 17 STANDARD BLACK TEXTURE TURKISH	KB.I170A.054
	1	KEYBOARD 104KEYS NSK-ALA0J AC7T JV50 INTERNAL 17 STANDARD BLACK TEXTURE UK	KB.I170A.055
	1	KEYBOARD 104KEYS NSK-ALA0J AC7T JV50 INTERNAL 17 STANDARD BLACK TEXTURE UK	KB.I170A.055
	1	KEYBOARD 104KEYS NSK-ALA0J AC7T JV50 INTERNAL 17 STANDARD BLACK TEXTURE SWEDISH	KB.I170A.051
	1	KEYBOARD 104KEYS NSK-ALA0J AC7T JV50 INTERNAL 17 STANDARD BLACK TEXTURE SWEDISH	KB.I170A.051
	1	KEYBOARD 104KEYS NSK-ALA0J AC7T JV50 INTERNAL 17 STANDARD BLACK TEXTURE CZECH/SLOVAK	KB.I170A.035
	1	KEYBOARD 104KEYS NSK-ALA0J AC7T JV50 INTERNAL 17 STANDARD BLACK TEXTURE CZECH/SLOVAK	KB.I170A.035
	1	KEYBOARD 104KEYS NSK-ALA0J AC7T JV50 INTERNAL 17 STANDARD BLACK TEXTURE BELGIAN	KB.I170A.033
	1	KEYBOARD 104KEYS NSK-ALA0J AC7T JV50 INTERNAL 17 STANDARD BLACK TEXTURE BELGIAN	KB.I170A.033
	1	KEYBOARD 104KEYS NSK-ALA0J AC7T JV50 INTERNAL 17 STANDARD BLACK TEXTURE BRAZILIAN PORTUGUESE	KB.I170A.034
	1	KEYBOARD 104KEYS NSK-ALA0J AC7T JV50 INTERNAL 17 STANDARD BLACK TEXTURE BRAZILIAN PORTUGUESE	KB.I170A.034
	1	KEYBOARD 103KEYS NSK-ALA0J AC7T JV50 INTERNAL 17 STANDARD BLACK TEXTURE US-INTERNATIONAL	KB.I170A.056
	1	KEYBOARD 103KEYS NSK-ALA0J AC7T JV50 INTERNAL 17 STANDARD BLACK TEXTURE US-INTERNATIONAL	KB.I170A.056
	1	KEYBOARD 104KEYS NSK-ALA0J AC7T JV50 INTERNAL 17 STANDARD BLACK TEXTURE SLOVE	KB.I170A.049
	1	KEYBOARD 104KEYS NSK-ALA0J AC7T JV50 INTERNAL 17 STANDARD BLACK TEXTURE SLOVE	KB.I170A.049
	1	KEYBOARD 104KEYS NSK-ALA0J AC7T JV50 INTERNAL 17 STANDARD BLACK TEXTURE NORDIC	KB.I170A.045
	1	KEYBOARD 104KEYS NSK-ALA0J AC7T JV50 INTERNAL 17 STANDARD BLACK TEXTURE NORDIC	KB.I170A.045
	1	KEYBOARD 104KEYS NSK-ALA0J AC7T JV50 INTERNAL 17 STANDARD BLACK TEXTURE FRENCH ARABIC	KB.I170A.038
	1	KEYBOARD 104KEYS NSK-ALA0J AC7T JV50 INTERNAL 17 STANDARD BLACK TEXTURE FRENCH ARABIC	KB.I170A.038
	1	KEYBOARD 104KEYS NSK-ALA0J AC7T JV50 INTERNAL 17 STANDARD BLACK TEXTURE FRENCH CANADIAN	KB.I170A.058
	1	KEYBOARD 104KEYS NSK-ALA0J AC7T JV50 INTERNAL 17 STANDARD BLACK TEXTURE FRENCH CANADIAN	KB.I170A.058

Category	No.	Part Name	Acer Part No.
LCD 	1	LED LCD MODULE 17.3" WXGA GLARE IMR BLUE W/ ANTENNA*2&CAMERA 0.3M	
	2	LED LCD CMO 17.3" WXGA+ GLARE N173O6-L02 LF 220NIT 8MS 600:1	LK.1730D.001
	2	LED LCD AUO 17.3" WXGA+ GLARE B173RW01-V0 LF 220NIT 8MS 600:1	LK.17305.001
	2	LED LCD LPL 17.3" WXGA+ GLARE LP173WD1-TLA1 LF 220NIT 8MS 600:1	LK.17308.001
	2	LED LCD AUO 17.3" WXGA+ GLARE B173RW01-V3 LF 220NIT 8MS 500:1	LK.17305.002
	2	LED LCD SAMSUNG 17.3" WXGA+ GLARE LTN173KT01-A01 LF 220NIT 8MS 600:1	LK.17306.001
	2	LED LCD LPL 17.3" WXGA+ GLARE LP173WD1-TLA3 LF 220NIT 8MS 600:1	LK.17308.002
MAINBOARD 	1	MAINBOARD JV71_CP AS7740 UMA INTEL HM55 LF W/ RTC BATTERY&MODEM BOARD	55.4GC01.051G
MEMORY 	1	SODIMM 1GB DDRIII 1066MHZ MICRON MT8JSF12864HZ-1G1F1 LF 128*8 0.065UM	KN.1GB04.015
	1	SODIMM 1GB DDRIII 1066MHZ ELPIDA EBJ10UE8BDS0-AE-F LF 128*8 0.065UM	KN.1GB09.012
	1	SODIMM 1GB DDRIII 1066MHZ SAMSUNG M471B2873EH1-CF8	KN.1GB0B.028
	1	SODIMM 1GB DDRIII 1066MHZ HYNIX HMT112S6BFR6C-G7N0 NO LF 64*16 0.055UM	KN.1GB0G.025
	1	SODIMM 2GB DDRIII 1066MHZ HYNIX HMT125S6BFR8C-G7 NO LF 128*8 0.055UM	KN.2GB0G.014
	1	SODIMM 2GB DDRIII 1066MHZ MICRON MT16JSF25664HZ-1G1F1 LF 128*8 0.065UM	KN.2GB04.015
	1	SODIMM 2GB DDRIII 1066MHZ ELPIDA EBJ21UE8BDS0-AE-F LF 128*8 0.065UM	KN.2GB09.006
	1	SODIMM 2GB DDRIII 1066MHZ SAMSUNG M471B5673EH1-CF8	KN.2GB0B.012
	1	SODIMM 4GB DDRIII 1333MHZ ELPIDA EBJ41UF8BAS0-DJ-F LF 256*8 0.055UM	KN.4GB09.001
	1	SODIMM 4GB DDRIII 1066MHZ SAMSUNG M471B5273BH1-CF8 LF 256*8 0.055UM	KN.4GB0B.007
MICROPHONE 	2	MICROPHONE	23.42282.001
	2	MICROPHONE	23.42283.001
MISCELLANEOUS	1	NAME PLATE AS7740	40.4GC02.001
	1	LCD SCREW RUBBER	47.PJA01.001
SCREWS	1	SCREW M2.5X6 H=0.7~0.8MM	86.00E12.536
	1	SCREW M2.5*L10 BLACK ZN	86.00F84.73A
	1	SCREW M2.5*L5 BLACK ZN+NYLOK	86.TK501.001
	1	SCREW M2.5XL4 D4.5 T0.8 GL	86.00H59.734
	1	SCREW M2.5L4 HALF NYLOK	86.00K61.534

Category	No.	Part Name	Acer Part No.
SCREWS	1	SCREW NYLOK NI M2 X L3	86.9A552.3R0
	1	SCREW M2 X L4 WAFER NI	86.9A552.4R0
	1	SCREW NI M2 X 6L	86.9A552.6R0
	1	SCREW MACH WAFER M3 X L4 NI	86.9A554.4R0
	1	SCREW M2.5 X L3.5	86.9A563.3R5
SPEAKER 	2	SPEAKER ON UPPER CASE	23.PJA01.002
	2	SPEAKER ON UPPER CASE	23.PJA01.002
	2	SPEAKER ON LOWER CASE	23.PJA01.001
	2	SPEAKER ON LOWER CASE	23.PJA01.001

Model Definition and Configuration

Aspire 7740/7740G Series

NOTE: All models have following common specifications: LCD (NLED17.3WXGA+G), card reader (5-in-1), NB chipset (HM55), Webcam (0.3M DV)

Model	RO	Country	Description	CPU	VGA Chip	VRAM 1	Memory 1/ Memory 2	HDD 1(GB)	ODD	Card Reader	Wireless LAN1	Bluetooth	Battery	Adapter	K/B	Power Cord
AS7740G-338G50Mn	EMEA	Spain	AS7740G-338G50Mn W7HP64ATES1 MC MADISON_PRO1GBCbk_V3 2*4G/500_L/6L2.2/5R/ CB_bgn_0.3D_HG_ES51	Ci3330M	MADISON_PRO	1G-DDR3 (64*16*8)	SO4GBIII10	N500GB5.4KS	NSM8XS	5 in 1- Build in	3rd WiFi 2x2 BGN	N	6CELL2.2	90W	Spanish (KB.I170A.050)	Continental
AS7740G-338G50Mn	EMEA	Eastern Europe	AS7740G-338G50Mn W7HP64ATEU4 MC MADISON_PRO1GBCbk_V3 2*4G/500_L/6L2.2/5R/ CB_bgn_0.3D_HG_SV21	Ci3330M	MADISON_PRO	1G-DDR3 (64*16*8)	SO4GBIII10	N500GB5.4KS	NSM8XS	5 in 1- Build in	3rd WiFi 2x2 BGN	N	6CELL2.2	90W	Sweden (KB.I170A.051)	Continental
AS7740G-338G50Mn	EMEA	Israel	AS7740G-338G50Mn W7HP64ATIL1 MC MADISON_PRO1GBCbk_V3 2*4G/500_L/6L2.2/5R/ CB_bgn_0.3D_HG_HE11	Ci3330M	MADISON_PRO	1G-DDR3 (64*16*8)	SO4GBIII10	N500GB5.4KS	NSM8XS	5 in 1- Build in	3rd WiFi 2x2 BGN	N	6CELL2.2	90W	US International w/ Hebrew (KB.I170A.057)	Israel
AS7740G-338G50Mn	EMEA	Luxembourg	AS7740G-338G50Mn W7HP64ATLUS MC MADISON_PRO1GBCbk_V3 2*4G/500_L/6L2.2/5R/ CB_bgn_0.3D_HG_IT41	Ci3330M	MADISON_PRO	1G-DDR3 (64*16*8)	SO4GBIII10	N500GB5.4KS	NSM8XS	5 in 1- Build in	3rd WiFi 2x2 BGN	N	6CELL2.2	90W	Swiss/G (KB.I170A.052)	Continental
AS7740G-338G50Mn	EMEA	Switzerland	AS7740G-338G50Mn W7HP64ATCH1 MC MADISON_PRO1GBCbk_V3 2*4G/500_L/6L2.2/5R/ CB_bgn_0.3D_HG_IT41	Ci3330M	MADISON_PRO	1G-DDR3 (64*16*8)	SO4GBIII10	N500GB5.4KS	NSM8XS	5 in 1- Build in	3rd WiFi 2x2 BGN	N	6CELL2.2	90W	Swiss/G (KB.I170A.052)	Swiss
AS7740G-338G50Mn	EMEA	Germany	AS7740G-338G50Mn W7HP64ATDE1 MC MADISON_PRO1GBCbk_V3 2*4G/500_L/6L2.2/5R/ CB_bgn_0.3D_HG_DE11	Ci3330M	MADISON_PRO	1G-DDR3 (64*16*8)	SO4GBIII10	N500GB5.4KS	NSM8XS	5 in 1- Build in	3rd WiFi 2x2 BGN	N	6CELL2.2	90W	German (KB.I170A.040)	Continental
AS7740G-338G50Mn	EMEA	Denmark	AS7740G-338G50Mn W7HP64ATDK2 MC MADISON_PRO1GBCbk_V3 2*4G/500_L/6L2.2/5R/ CB_bgn_0.3D_HG_ENS1	Ci3330M	MADISON_PRO	1G-DDR3 (64*16*8)	SO4GBIII10	N500GB5.4KS	NSM8XS	5 in 1- Build in	3rd WiFi 2x2 BGN	N	6CELL2.2	90W	Nordic (KB.I170A.045)	Danish/ Continental
AS7740G-338G50Mn	EMEA	Serbia/ Macedonia	AS7740G-338G50Mn W7HP64ATCS1 MC MADISON_PRO1GBCbk_V3 2*4G/500_L/6L2.2/5R/ CB_bgn_0.3D_HG_SL11	Ci3330M	MADISON_PRO	1G-DDR3 (64*16*8)	SO4GBIII10	N500GB5.4KS	NSM8XS	5 in 1- Build in	3rd WiFi 2x2 BGN	N	6CELL2.2	90W	SLO/CRO (KB.I170A.049)	Continental
AS7740G-338G50Mn	EMEA	Eastern Europe	AS7740G-338G50Mn W7HP64ATEU7 MC MADISON_PRO1GBCbk_V3 2*4G/500_L/6L2.2/5R/ CB_bgn_0.3D_HG_ENQ1	Ci3330M	MADISON_PRO	1G-DDR3 (64*16*8)	SO4GBIII10	N500GB5.4KS	NSM8XS	5 in 1- Build in	3rd WiFi 2x2 BGN	N	6CELL2.2	90W	SLO/CRO (KB.I170A.049)	Continental
AS7740G-338G50Mn	EMEA	Czech	AS7740G-338G50Mn W7HP64ATCZ2 MC MADISON_PRO1GBCbk_V3 2*4G/500_L/6L2.2/5R/ CB_bgn_0.3D_HG_SK11	Ci3330M	MADISON_PRO	1G-DDR3 (64*16*8)	SO4GBIII10	N500GB5.4KS	NSM8XS	5 in 1- Build in	3rd WiFi 2x2 BGN	N	6CELL2.2	90W	CZ/SK (KB.I170A.035)	Continental
AS7740G-438G64Mn	EMEA	Spain	AS7740G-438G64Mn W7HP64ATES1 MC MADISON_PRO1GBCbk_V3 2*4G/640/8L2.4/5R/ CB_bgn_0.3D_HG_ES51	Ci5430M	MADISON_PRO	1G-DDR3 (64*16*8)	SO4GBIII10	N640GB5.4KS	NSM8XS	5 in 1- Build in	3rd WiFi 2x2 BGN	N	8CELL2.4	90W	Spanish (KB.I170A.050)	Continental
AS7740G-338G50Mn	EMEA	UK	AS7740G-338G50Mn W7HP64ATGB1 MC MADISON_PRO1GBCbk_V3 4G+2G/500_L/BT/6L2.2/ 5R/CB_bgn_0.3D_HG_EN11	Ci3330M	MADISON_PRO	1G-DDR3 (64*16*8)	SO4GBIII10	N500GB5.4KS	NSM8XS	5 in 1- Build in	3rd WiFi 2x2 BGN	BT 2.1	6CELL2.2	90W	UK (KB.I170A.055)	UK
AS7740G-338G50Mn	EMEA	UK	AS7740G-338G50Mn W7HP64ATGB1 MC MADISON_PRO1GBCbk_V3 2*4G/500_L/6L2.2/5R/ CB_bgn_0.3D_HG_EN11	Ci3330M	MADISON_PRO	1G-DDR3 (64*16*8)	SO4GBIII10	N500GB5.4KS	NSM8XS	5 in 1- Build in	3rd WiFi 2x2 BGN	N	6CELL2.2	90W	UK (KB.I170A.055)	UK
AS7740G-338G50Mn	EMEA	Cyprus	AS7740G-338G50Mn W7HP64ATCY1 MC MADISON_PRO1GBCbk_V3 2*4G/500_L/6L2.2/5R/ CB_bgn_0.3D_HG_ES61	Ci3330M	MADISON_PRO	1G-DDR3 (64*16*8)	SO4GBIII10	N500GB5.4KS	NSM8XS	5 in 1- Build in	3rd WiFi 2x2 BGN	N	6CELL2.2	90W	UK (KB.I170A.055)	UK
AS7740G-338G50Mn	EMEA	Latvia	AS7740G-338G50Mn W7HP64ATLV1 MC MADISON_PRO1GBCbk_V3 2*4G/500_L/6L2.2/5R/ CB_bgn_0.3D_HG_RU22	Ci3330M	MADISON_PRO	1G-DDR3 (64*16*8)	SO4GBIII10	N500GB5.4KS	NSM8XS	5 in 1- Build in	3rd WiFi 2x2 BGN	N	6CELL2.2	90W	Russian (KB.I170A.048)	Continental
AS7740G-338G50Mi	EMEA	Ukraine	AS7740G-338G50Mi W7HP64RUATUK1 MC MADISON_PRO1GBCbk_V3 2*4G/500_L/6L2.2/5R/ CB_bgn_0.3D_HG_RU61	Ci3330M	MADISON_PRO	1G-DDR3 (64*16*8)	SO4GBIII10	N500GB5.4KS	NSM8XS	5 in 1- Build in	3rd WiFi BG	N	6CELL2.2	90W	Russian (KB.I170A.048)	Continental
AS7740G-338G50Mi	EMEA	Russia	AS7740G-338G50Mi W7HP64RUATRU1 MC MADISON_PRO1GBCbk_V3 2*4G/500_L/6L2.2/5R/ CB_bgn_0.3D_HG_RU11	Ci3330M	MADISON_PRO	1G-DDR3 (64*16*8)	SO4GBIII10	N500GB5.4KS	NSM8XS	5 in 1- Build in	3rd WiFi BG	N	6CELL2.2	90W	Russian (KB.I170A.048)	Continental
AS7740G-338G50Mn	EMEA	Middle East	AS7740G-338G50Mn Em W7HP64EMATME4 MC MADISON_PRO1GBCbk_V3 2*4G/500_L/6L2.2/5R/ CB_bgn_0.3D_HG_RU61	Ci3330M	MADISON_PRO	1G-DDR3 (64*16*8)	SO4GBIII10	N500GB5.4KS	NSM8XS	5 in 1- Build in	3rd WiFi 2x2 BGN	N	6CELL2.2	90W	Russian (KB.I170A.048)	Continental

AS7740G-338G50Mn	EMEA	Middle East	AS7740G-338G50Mn EM W7HP64EMATME4 MC MADISON_PRO1GBCbK_V3 2*4G/500_L/6L2.2/5R/ CB_bgn_0.3D_HG_ES61	Ci3330M	MADISON_PRO	1G-DDR3 (64*16*8)	SO4GBIII10	N500GB5.4KS	NSM8XS	5 in 1- Build in	3rd WiFi 2x2 BGN	N	6CELL2.2	90W	Russian (KB.I170A.048)	Continental
AS7740G-338G50Mn	EMEA	Turkey	AS7740G-338G50Mn EM W7HP64EMATTR1 MC MADISON_PRO1GBCbK_V3 2*4G/500_L/6L2.2/5R/ CB_bgn_0.3D_HG_TR31	Ci3330M	MADISON_PRO	1G-DDR3 (64*16*8)	SO4GBIII10	N500GB5.4KS	NSM8XS	5 in 1- Build in	3rd WiFi 2x2 BGN	N	6CELL2.2	90W	Turkish (KB.I170A.054)	Continental
AS7740G-338G50Mn	EMEA	Belgium	AS7740G-338G50Mn W7HP64ATBE1 MC MADISON_PRO1GBCbK_V3 2*4G/500_L/6L2.2/5R/ CB_bgn_0.3D_HG_NL11	Ci3330M	MADISON_PRO	1G-DDR3 (64*16*8)	SO4GBIII10	N500GB5.4KS	NSM8XS	5 in 1- Build in	3rd WiFi 2x2 BGN	N	6CELL2.2	90W	Belgium (KB.I170A.033)	Continental
AS7740G-338G50Mn	EMEA	Middle East	AS7740G-338G50Mn EM W7HP64EMATME2 MC MADISON_PRO1GBCbK_V3 2*4G/500_L/6L2.2/5R/ CB_bgn_0.3D_HG_ES61	Ci3330M	MADISON_PRO	1G-DDR3 (64*16*8)	SO4GBIII10	N500GB5.4KS	NSM8XS	5 in 1- Build in	3rd WiFi 2x2 BGN	N	6CELL2.2	90W	Arabic (KB.I170A.032)	UK and US-110V
AS7740G-338G50Mn	EMEA	Middle East	AS7740G-338G50Mn EM W7HP64EMATME2 MC MADISON_PRO1GBCbK_V3 2*4G/500_L/6L2.2/5R/ CB_bgn_0.3D_HG_AR21	Ci3330M	MADISON_PRO	1G-DDR3 (64*16*8)	SO4GBIII10	N500GB5.4KS	NSM8XS	5 in 1- Build in	3rd WiFi 2x2 BGN	N	6CELL2.2	90W	Arabic (KB.I170A.032)	UK and US-110V
AS7740G-338G50Mn	EMEA	Middle East	AS7740G-338G50Mn EM W7HP64EMATME2 MC MADISON_PRO1GBCbK_V3 2*4G/500_L/6L2.2/5R/ CB_bgn_0.3D_HG_AR11	Ci3330M	MADISON_PRO	1G-DDR3 (64*16*8)	SO4GBIII10	N500GB5.4KS	NSM8XS	5 in 1- Build in	3rd WiFi 2x2 BGN	N	6CELL2.2	90W	Arabic (KB.I170A.032)	UK and US-110V
AS7740G-338G50Mn	EMEA	Italy	AS7740G-338G50Mn W7HP64ATIT1 MC MADISON_PRO1GBCbK_V3 2*4G/500_L/6L2.2/5R/ CB_bgn_0.3D_HG_IT11	Ci3330M	MADISON_PRO	1G-DDR3 (64*16*8)	SO4GBIII10	N500GB5.4KS	NSM8XS	5 in 1- Build in	3rd WiFi 2x2 BGN	N	6CELL2.2	90W	Italian (KB.I170A.043)	Italian
AS7740G-338G50Mn	EMEA	Hungary	AS7740G-338G50Mn W7HP64ATHU1 MC MADISON_PRO1GBCbK_V3 2*4G/500_L/6L2.2/5R/ CB_bgn_0.3D_HG_HU11	Ci3330M	MADISON_PRO	1G-DDR3 (64*16*8)	SO4GBIII10	N500GB5.4KS	NSM8XS	5 in 1- Build in	3rd WiFi 2x2 BGN	N	6CELL2.2	90W	Hungarian (KB.I170A.042)	Continental
AS7740G-338G50Mn	EMEA	Middle East	AS7740G-338G50Mn EM W7HP64EMATME6 MC MADISON_PRO1GBCbK_V3 2*4G/500_L/6L2.2/5R/ CB_bgn_0.3D_HG_ES61	Ci3330M	MADISON_PRO	1G-DDR3 (64*16*8)	SO4GBIII10	N500GB5.4KS	NSM8XS	5 in 1- Build in	3rd WiFi 2x2 BGN	N	6CELL2.2	90W	US International (KB.I170A.056)	UK
AS7740G-338G50Mn	EMEA	South Africa	AS7740G-338G50Mn EM W7HP64EMATZA4 MC MADISON_PRO1GBCbK_V3 2*4G/500_L/6L2.2/5R/ CB_bgn_0.3D_HG_ES61	Ci3330M	MADISON_PRO	1G-DDR3 (64*16*8)	SO4GBIII10	N500GB5.4KS	NSM8XS	5 in 1- Build in	3rd WiFi 2x2 BGN	N	6CELL2.2	90W	US International (KB.I170A.056)	UK
AS7740G-338G50Mn	EMEA	South Africa	AS7740G-338G50Mn EM W7HP64EMATZA2 MC MADISON_PRO1GBCbK_V3 2*4G/500_L/6L2.2/5R/ CB_bgn_0.3D_HG_ES61	Ci3330M	MADISON_PRO	1G-DDR3 (64*16*8)	SO4GBIII10	N500GB5.4KS	NSM8XS	5 in 1- Build in	3rd WiFi 2x2 BGN	N	6CELL2.2	90W	US International (KB.I170A.056)	AF
AS7740G-338G50Mn	EMEA	Poland	AS7740G-338G50Mn W7HP64ATPL1 MC MADISON_PRO1GBCbK_V3 2*4G/500_L/6L2.2/5R/ CB_bgn_0.3D_HG_PL11	Ci3330M	MADISON_PRO	1G-DDR3 (64*16*8)	SO4GBIII10	N500GB5.4KS	NSM8XS	5 in 1- Build in	3rd WiFi 2x2 BGN	N	6CELL2.2	90W	US International (KB.I170A.056)	Continental
AS7740G-338G50Mn	EMEA	Holland	AS7740G-338G50Mn W7HP64ATNL1 MC MADISON_PRO1GBCbK_V3 2*4G/500_L/6L2.2/5R/ CB_bgn_0.3D_HG_NL11	Ci3330M	MADISON_PRO	1G-DDR3 (64*16*8)	SO4GBIII10	N500GB5.4KS	NSM8XS	5 in 1- Build in	3rd WiFi 2x2 BGN	N	6CELL2.2	90W	US International (KB.I170A.056)	Continental
AS7740G-338G50Mn	EMEA	Eastern Europe	AS7740G-338G50Mn W7HP64ATEU5 MC MADISON_PRO1GBCbK_V3 2*4G/500_L/6L2.2/5R/ CB_bgn_0.3D_HG_RO11	Ci3330M	MADISON_PRO	1G-DDR3 (64*16*8)	SO4GBIII10	N500GB5.4KS	NSM8XS	5 in 1- Build in	3rd WiFi 2x2 BGN	N	6CELL2.2	90W	US International (KB.I170A.056)	Continental
AS7740G-338G50Mn	EMEA	Eastern Europe	AS7740G-338G50Mn W7HP64ATEU5 MC MADISON_PRO1GBCbK_V3 2*4G/500_L/6L2.2/5R/ CB_bgn_0.3D_HG_PL71	Ci3330M	MADISON_PRO	1G-DDR3 (64*16*8)	SO4GBIII10	N500GB5.4KS	NSM8XS	5 in 1- Build in	3rd WiFi 2x2 BGN	N	6CELL2.2	90W	US International (KB.I170A.056)	Continental
AS7740G-624G50Bn	WW	GCTWN	AS7740G-624G50Bn W7HP64AWW1 MC MADISON_PRO1GBCbK_V3 2*2G/500_L/BT/8L2.4/5R/ CB_bgn_0.3D_HG_ES61	Ci7620M	MADISON_PRO	1G-DDR3 (64*16*8)	SO2GBIII10	N500GB5.4KS	NBDCB4XS	5 in 1- Build in	3rd WiFi 2x2 BGN	BT 2.1	8CELL2.4	90W	US International (KB.I170A.056)	US and Continental
AS7740G-338G50Mn	EMEA	South Africa	AS7740G-338G50Mn EM W7HP64EMATZA1 MC MADISON_PRO1GBCbK_V3 2*4G/500_L/6L2.2/5R/ CB_bgn_0.3D_HG_ES81	Ci3330M	MADISON_PRO	1G-DDR3 (64*16*8)	SO4GBIII10	N500GB5.4KS	NSM8XS	5 in 1- Build in	3rd WiFi 2x2 BGN	N	6CELL2.2	90W	French (KB.I170A.039)	Continental
AS7740G-338G50Mn	EMEA	Middle East	AS7740G-338G50Mn EM W7HP64EMATME3 MC MADISON_PRO1GBCbK_V3 2*4G/500_L/6L2.2/5R/ CB_bgn_0.3D_HG_ES81	Ci3330M	MADISON_PRO	1G-DDR3 (64*16*8)	SO4GBIII10	N500GB5.4KS	NSM8XS	5 in 1- Build in	3rd WiFi 2x2 BGN	N	6CELL2.2	90W	French (KB.I170A.039)	Continental
AS7740G-338G64Mn	EMEA	France	AS7740G-338G64Mn W7HP64ATFR1 MC MADISON_PRO1GBCbK_V3 2*4G/640/6L2.2/5R/ CB_bgn_0.3D_HG_FR21	Ci3330M	MADISON_PRO	1G-DDR3 (64*16*8)	SO4GBIII10	N640GB5.4KS	NSM8XS	5 in 1- Build in	3rd WiFi 2x2 BGN	N	6CELL2.2	90W	French (KB.I170A.039)	Continental
AS7740G-338G64Mn	EMEA	France	AS7740G-338G64Mn W7HP64ATFR1 MC MADISON_PRO1GBCbK_V3 4G+2G/640/6L2.2/5R/ CB_bgn_0.3D_HG_FR21	Ci3330M	MADISON_PRO	1G-DDR3 (64*16*8)	SO4GBIII10 / SO2GBIII10	N640GB5.4KS	NSM8XS	5 in 1- Build in	3rd WiFi 2x2 BGN	N	6CELL2.2	90W	French (KB.I170A.039)	Continental
AS7740G-338G50Mn	EMEA	Portugal	AS7740G-338G50Mn W7HP64ATPT1 MC MADISON_PRO1GBCbK_V3 2*4G/500_L/6L2.2/5R/ CB_bgn_0.3D_HG_PT11	Ci3330M	MADISON_PRO	1G-DDR3 (64*16*8)	SO4GBIII10	N500GB5.4KS	NSM8XS	5 in 1- Build in	3rd WiFi 2x2 BGN	N	6CELL2.2	90W	Portuguese (KB.I170A.047)	Continental

AS7740G-336G50Mn	EMEA	Middle East	AS7740G-336G50Mn EM W7HP64EMATME9 MC MADISON_PRO1GBCbK_V3 2*4G/500_L/6L2.2/5R/ CB_bgn_0.3D_HG_ES81	Ci3330M	MADISON_PRO	1G-DDR3 (64*16*8)	SO4GBIII10	N500GB5.4KS	NSM8XS	5 in 1- Build in	3rd WiFi 2x2 BGN	N	6CELL2.2	90W	FR/Arabic (KB.I170A.038)	Continental
AS7740G-336G50Mn	EMEA	Algeria	AS7740G-336G50Mn EM W7HP64EMATD21 MC MADISON_PRO1GBCbK_V3 2*4G/500_L/6L2.2/5R/ CB_bgn_0.3D_HG_ES81	Ci3330M	MADISON_PRO	1G-DDR3 (64*16*8)	SO4GBIII10	N500GB5.4KS	NSM8XS	5 in 1- Build in	3rd WiFi 2x2 BGN	N	6CELL2.2	90W	FR/Arabic (KB.I170A.038)	Continental
AS7740G-336G50Mn	EMEA	Middle East	AS7740G-336G50Mn EM W7HP64EMATME9 MC MADISON_PRO1GBCbK_V3 4G+2G/500_L/6L2.2/5R/ CB_bgn_0.3D_HG_ES81	Ci3330M	MADISON_PRO	1G-DDR3 (64*16*8)	SO4GBIII10 / SO2GBIII10	N500GB5.4KS	NSM8XS	5 in 1- Build in	3rd WiFi 2x2 BGN	N	6CELL2.2	90W	FR/Arabic (KB.I170A.038)	Continental
AS7740G-336G50Mn	EMEA	Portugal	AS7740G-336G50Mn W7HP64ATPT1 MC MADISON_PRO1GBCbK_V3 4G+2G/500_L/6L2.2/5R/ CB_bgn_0.3D_HG_PT11	Ci3330M	MADISON_PRO	1G-DDR3 (64*16*8)	SO4GBIII10 / SO2GBIII10	N500GB5.4KS	NSM8XS	5 in 1- Build in	3rd WiFi 2x2 BGN	N	6CELL2.2	90W	Portuguese (KB.I170A.047)	Continental
AS7740G-336G50Mn	EMEA	Israel	AS7740G-336G50Mn W7HP64ATIL1 MC MADISON_PRO1GBCbK_V3 4G+2G/500_L/6L2.2/5R/ CB_bgn_0.3D_HG_HE11	Ci3330M	MADISON_PRO	1G-DDR3 (64*16*8)	SO4GBIII10 / SO2GBIII10	N500GB5.4KS	NSM8XS	5 in 1- Build in	3rd WiFi 2x2 BGN	N	6CELL2.2	90W	US International w/ Hebrew (KB.I170A.057)	Israel
AS7740G-336G50Mn	EMEA	Greece	AS7740G-336G50Mn W7HP64ATGR1 MC MADISON_PRO1GBCbK_V3 2*4G/500_L/6L2.2/5R/ CB_bgn_0.3D_HG_EL31	Ci3330M	MADISON_PRO	1G-DDR3 (64*16*8)	SO4GBIII10	N500GB5.4KS	NSM8XS	5 in 1- Build in	3rd WiFi 2x2 BGN	N	6CELL2.2	90W	Greek (KB.I170A.041)	Continental
AS7740G-336G50Mn	EMEA	Greece	AS7740G-336G50Mn W7HP64ATGR1 MC MADISON_PRO1GBCbK_V3 4G+2G/500_L/6L2.2/5R/ CB_bgn_0.3D_HG_EL31	Ci3330M	MADISON_PRO	1G-DDR3 (64*16*8)	SO4GBIII10 / SO2GBIII10	N500GB5.4KS	NSM8XS	5 in 1- Build in	3rd WiFi 2x2 BGN	N	6CELL2.2	90W	Greek (KB.I170A.041)	Continental
AS7740G-336G50Mn	EMEA	Eastern Europe	AS7740G-336G50Mn W7HP64ATEU4 MC MADISON_PRO1GBCbK_V3 4G+2G/500_L/6L2.2/5R/ CB_bgn_0.3D_HG_SV21	Ci3330M	MADISON_PRO	1G-DDR3 (64*16*8)	SO4GBIII10 / SO2GBIII10	N500GB5.4KS	NSM8XS	5 in 1- Build in	3rd WiFi 2x2 BGN	N	6CELL2.2	90W	Sweden (KB.I170A.051)	Continental
AS7740G-336G50Mn	EMEA	Algeria	AS7740G-336G50Mn EM W7HP64EMATD21 MC MADISON_PRO1GBCbK_V3 4G+2G/500_L/6L2.2/5R/ CB_bgn_0.3D_HG_ES81	Ci3330M	MADISON_PRO	1G-DDR3 (64*16*8)	SO4GBIII10 / SO2GBIII10	N500GB5.4KS	NSM8XS	5 in 1- Build in	3rd WiFi 2x2 BGN	N	6CELL2.2	90W	FR/Arabic (KB.I170A.038)	Continental
AS7740G-336G50Mn	EMEA	France	AS7740G-336G50Mn W7HP64ATFR1 MC MADISON_PRO1GBCbK_V3 4G+2G/500_L/6L2.2/5R/ CB_bgn_0.3D_HG_FR21	Ci3330M	MADISON_PRO	1G-DDR3 (64*16*8)	SO4GBIII10 / SO2GBIII10	N500GB5.4KS	NSM8XS	5 in 1- Build in	3rd WiFi 2x2 BGN	N	6CELL2.2	90W	French (KB.I170A.039)	Continental
AS7740G-336G50Mn	EMEA	France	AS7740G-336G50Mn W7HP64ATFR1 MC MADISON_PRO1GBCbK_V3 2*4G/500_L/6L2.2/5R/ CB_bgn_0.3D_HG_FR21	Ci3330M	MADISON_PRO	1G-DDR3 (64*16*8)	SO4GBIII10	N500GB5.4KS	NSM8XS	5 in 1- Build in	3rd WiFi 2x2 BGN	N	6CELL2.2	90W	French (KB.I170A.039)	Continental
AS7740G-336G50Mn	EMEA	Middle East	AS7740G-336G50Mn EM W7HP64EMATME3 MC MADISON_PRO1GBCbK_V3 4G+2G/500_L/6L2.2/5R/ CB_bgn_0.3D_HG_ES81	Ci3330M	MADISON_PRO	1G-DDR3 (64*16*8)	SO4GBIII10 / SO2GBIII10	N500GB5.4KS	NSM8XS	5 in 1- Build in	3rd WiFi 2x2 BGN	N	6CELL2.2	90W	French (KB.I170A.039)	Continental
AS7740G-336G50Mn	EMEA	South Africa	AS7740G-336G50Mn EM W7HP64EMATZ1 MC MADISON_PRO1GBCbK_V3 4G+2G/500_L/6L2.2/5R/ CB_bgn_0.3D_HG_ES81	Ci3330M	MADISON_PRO	1G-DDR3 (64*16*8)	SO4GBIII10 / SO2GBIII10	N500GB5.4KS	NSM8XS	5 in 1- Build in	3rd WiFi 2x2 BGN	N	6CELL2.2	90W	French (KB.I170A.039)	Continental
AS7740G-336G50Mn	EMEA	Poland	AS7740G-336G50Mn W7HP64ATPL1 MC MADISON_PRO1GBCbK_V3 4G+2G/500_L/6L2.2/5R/ CB_bgn_0.3D_HG_PL11	Ci3330M	MADISON_PRO	1G-DDR3 (64*16*8)	SO4GBIII10 / SO2GBIII10	N500GB5.4KS	NSM8XS	5 in 1- Build in	3rd WiFi 2x2 BGN	N	6CELL2.2	90W	US International (KB.I170A.056)	Continental
AS7740G-336G50Mn	EMEA	Eastern Europe	AS7740G-336G50Mn W7HP64ATEU5 MC MADISON_PRO1GBCbK_V3 4G+2G/500_L/6L2.2/5R/ CB_bgn_0.3D_HG_PL71	Ci3330M	MADISON_PRO	1G-DDR3 (64*16*8)	SO4GBIII10 / SO2GBIII10	N500GB5.4KS	NSM8XS	5 in 1- Build in	3rd WiFi 2x2 BGN	N	6CELL2.2	90W	US International (KB.I170A.056)	Continental
AS7740G-336G50Mn	EMEA	Eastern Europe	AS7740G-336G50Mn W7HP64ATEU5 MC MADISON_PRO1GBCbK_V3 4G+2G/500_L/6L2.2/5R/ CB_bgn_0.3D_HG_RO11	Ci3330M	MADISON_PRO	1G-DDR3 (64*16*8)	SO4GBIII10 / SO2GBIII10	N500GB5.4KS	NSM8XS	5 in 1- Build in	3rd WiFi 2x2 BGN	N	6CELL2.2	90W	US International (KB.I170A.056)	Continental
AS7740G-336G50Mn	EMEA	Holland	AS7740G-336G50Mn W7HP64ATNL1 MC MADISON_PRO1GBCbK_V3 4G+2G/500_L/6L2.2/5R/ CB_bgn_0.3D_HG_NL11	Ci3330M	MADISON_PRO	1G-DDR3 (64*16*8)	SO4GBIII10 / SO2GBIII10	N500GB5.4KS	NSM8XS	5 in 1- Build in	3rd WiFi 2x2 BGN	N	6CELL2.2	90W	US International (KB.I170A.056)	Continental
AS7740G-334G50Mn	EMEA	South Africa	AS7740G-334G50Mn EM W7HP64EMATZ2 MC MADISON_PRO1GBCbK_V3 2*2G/500_L/6L2.2/5R/ CB_bgn_0.3D_HG_ES61	Ci3330M	MADISON_PRO	1G-DDR3 (64*16*8)	SO4GBIII10 / SO2GBIII10	N500GB5.4KS	NSM8XS	5 in 1- Build in	3rd WiFi 2x2 BGN	N	6CELL2.2	90W	US International (KB.I170A.056)	AF
AS7740G-336G50Mn	EMEA	Luxembourg	AS7740G-336G50Mn W7HP64ATLU3 MC MADISON_PRO1GBCbK_V3 4G+2G/500_L/6L2.2/5R/ CB_bgn_0.3D_HG_IT41	Ci3330M	MADISON_PRO	1G-DDR3 (64*16*8)	SO4GBIII10 / SO2GBIII10	N500GB5.4KS	NSM8XS	5 in 1- Build in	3rd WiFi 2x2 BGN	N	6CELL2.2	90W	Swiss/G (KB.I170A.052)	Continental
AS7740G-336G50Mn	EMEA	Switzerland	AS7740G-336G50Mn W7HP64ATCH1 MC MADISON_PRO1GBCbK_V3 4G+2G/500_L/6L2.2/5R/ CB_bgn_0.3D_HG_IT41	Ci3330M	MADISON_PRO	1G-DDR3 (64*16*8)	SO4GBIII10 / SO2GBIII10	N500GB5.4KS	NSM8XS	5 in 1- Build in	3rd WiFi 2x2 BGN	N	6CELL2.2	90W	Swiss/G (KB.I170A.052)	Swiss
AS7740G-336G50Mn	EMEA	Austria	AS7740G-336G50Mn W7HP64ATAT1 MC MADISON_PRO1GBCbK_V3 2*4G/500_L/6L2.2/5R/ CB_bgn_0.3D_HG_DE61	Ci3330M	MADISON_PRO	1G-DDR3 (64*16*8)	SO4GBIII10	N500GB5.4KS	NSM8XS	5 in 1- Build in	3rd WiFi 2x2 BGN	N	6CELL2.2	90W	German (KB.I170A.040)	Continental

AS7740G-336G50Mn	EMEA	Austria	AS7740G-336G50Mn W7HP64ATAT1 MC MADISON_PRO1GBCbK_V3 4G+2G/500_L/6L2.2/5R/ CB_bgn_0.3D_HG_DE61	Ci3330M	MADISON_PRO	1G-DDR3 (64*16*8)	SO4GBIII10 / SO2GBIII10	N500GB5.4KS	NSM8XS	5 in 1- Build in	3rd WiFi 2x2 BGN	N	6CELL2.2	90W	German (KB.I170A.040)	Continental
AS7740G-336G50Mn	EMEA	Germany	AS7740G-336G50Mn W7HP64ATDE1 MC MADISON_PRO1GBCbK_V3 4G+2G/500_L/6L2.2/5R/ CB_bgn_0.3D_HG_DE11	Ci3330M	MADISON_PRO	1G-DDR3 (64*16*8)	SO4GBIII10 / SO2GBIII10	N500GB5.4KS	NSM8XS	5 in 1- Build in	3rd WiFi 2x2 BGN	N	6CELL2.2	90W	German (KB.I170A.040)	Continental
AS7740G-336G50Mn	EMEA	Denmark	AS7740G-336G50Mn W7HP64ATDK2 MC MADISON_PRO1GBCbK_V3 4G+2G/500_L/6L2.2/5R/ CB_bgn_0.3D_HG_ENS1	Ci3330M	MADISON_PRO	1G-DDR3 (64*16*8)	SO4GBIII10 / SO2GBIII10	N500GB5.4KS	NSM8XS	5 in 1- Build in	3rd WiFi 2x2 BGN	N	6CELL2.2	90W	Nordic (KB.I170A.045)	Danish/ Continental
AS7740G-336G50Mn	EMEA	Eastern Europe	AS7740G-336G50Mn W7HP64ATEU7 MC MADISON_PRO1GBCbK_V3 4G+2G/500_L/6L2.2/5R/ CB_bgn_0.3D_HG_ENQ1	Ci3330M	MADISON_PRO	1G-DDR3 (64*16*8)	SO4GBIII10 / SO2GBIII10	N500GB5.4KS	NSM8XS	5 in 1- Build in	3rd WiFi 2x2 BGN	N	6CELL2.2	90W	SLO/CRO (KB.I170A.049)	Continental
AS7740G-336G50Mn	EMEA	Eastern Europe	AS7740G-336G50Mn W7HP64ATEU7 MC MADISON_PRO1GBCbK_V3 2*4G/500_L/6L2.2/5R/ CB_bgn_0.3D_HG_SL11	Ci3330M	MADISON_PRO	1G-DDR3 (64*16*8)	SO4GBIII10 / SO2GBIII10	N500GB5.4KS	NSM8XS	5 in 1- Build in	3rd WiFi 2x2 BGN	N	6CELL2.2	90W	SLO/CRO (KB.I170A.049)	Continental
AS7740G-336G50Mn	EMEA	Serbia/ Macedonia	AS7740G-336G50Mn W7HP64ATCS1 MC MADISON_PRO1GBCbK_V3 4G+2G/500_L/6L2.2/5R/ CB_bgn_0.3D_HG_SL11	Ci3330M	MADISON_PRO	1G-DDR3 (64*16*8)	SO4GBIII10 / SO2GBIII10	N500GB5.4KS	NSM8XS	5 in 1- Build in	3rd WiFi 2x2 BGN	N	6CELL2.2	90W	SLO/CRO (KB.I170A.049)	Continental
AS7740G-336G50Mn	EMEA	Czech	AS7740G-336G50Mn W7HP64ATCZ2 MC MADISON_PRO1GBCbK_V3 4G+2G/500_L/6L2.2/5R/ CB_bgn_0.3D_HG_SK11	Ci3330M	MADISON_PRO	1G-DDR3 (64*16*8)	SO4GBIII10 / SO2GBIII10	N500GB5.4KS	NSM8XS	5 in 1- Build in	3rd WiFi 2x2 BGN	N	6CELL2.2	90W	CZ/SK (KB.I170A.035)	Continental
AS7740G-336G50Mn	EMEA	Spain	AS7740G-336G50Mn W7HP64ATES1 MC MADISON_PRO1GBCbK_V3 4G+2G/500_L/6L2.2/5R/ CB_bgn_0.3D_HG_ES51	Ci3330M	MADISON_PRO	1G-DDR3 (64*16*8)	SO4GBIII10 / SO2GBIII10	N500GB5.4KS	NSM8XS	5 in 1- Build in	3rd WiFi 2x2 BGN	N	6CELL2.2	90W	Spanish (KB.I170A.050)	Continental
AS7740G-336G50Mn	EMEA	UK	AS7740G-336G50Mn W7HP64ATGB1 MC MADISON_PRO1GBCbK_V3 4G+2G/500_L/6L2.2/5R/ CB_bgn_0.3D_HG_EN11	Ci3330M	MADISON_PRO	1G-DDR3 (64*16*8)	SO4GBIII10 / SO2GBIII10	N500GB5.4KS	NSM8XS	5 in 1- Build in	3rd WiFi 2x2 BGN	N	6CELL2.2	90W	UK (KB.I170A.055)	UK
AS7740G-336G50Mn	EMEA	Cyprus	AS7740G-336G50Mn W7HP64ATCY1 MC MADISON_PRO1GBCbK_V3 4G+2G/500_L/6L2.2/5R/ CB_bgn_0.3D_HG_ES61	Ci3330M	MADISON_PRO	1G-DDR3 (64*16*8)	SO4GBIII10 / SO2GBIII10	N500GB5.4KS	NSM8XS	5 in 1- Build in	3rd WiFi 2x2 BGN	N	6CELL2.2	90W	UK (KB.I170A.055)	UK
AS7740G-336G50Mn	EMEA	Latvia	AS7740G-336G50Mn W7HP64ATLV1 MC MADISON_PRO1GBCbK_V3 4G+2G/500_L/6L2.2/5R/ CB_bgn_0.3D_HG_RU22	Ci3330M	MADISON_PRO	1G-DDR3 (64*16*8)	SO4GBIII10 / SO2GBIII10	N500GB5.4KS	NSM8XS	5 in 1- Build in	3rd WiFi 2x2 BGN	N	6CELL2.2	90W	Russian (KB.I170A.048)	Continental
AS7740G-336G50Mi	EMEA	Ukraine	AS7740G-336G50Mi W7HP64RUATUK1 MC MADISON_PRO1GBCbK_V3 4G+2G/500_L/6L2.2/5R/ CB_bgn_0.3D_HG_RU61	Ci3330M	MADISON_PRO	1G-DDR3 (64*16*8)	SO4GBIII10 / SO2GBIII10	N500GB5.4KS	NSM8XS	5 in 1- Build in	3rd WiFi BG	N	6CELL2.2	90W	Russian (KB.I170A.048)	Continental
AS7740G-336G50Mi	EMEA	Russia	AS7740G-336G50Mi W7HP64RUATRU1 MC MADISON_PRO1GBCbK_V3 4G+2G/500_L/6L2.2/5R/ CB_bgn_0.3D_HG_RU11	Ci3330M	MADISON_PRO	1G-DDR3 (64*16*8)	SO4GBIII10 / SO2GBIII10	N500GB5.4KS	NSM8XS	5 in 1- Build in	3rd WiFi BG	N	6CELL2.2	90W	Russian (KB.I170A.048)	Continental
AS7740G-334G50Mi	EMEA	Ukraine	AS7740G-334G50Mi W7HP64RUATUK1 MC MADISON_PRO1GBCbK_V3 2*2G/500_L/6L2.2/5R/ CB_bgn_0.3D_HG_RU61	Ci3330M	MADISON_PRO	1G-DDR3 (64*16*8)	SO4GBIII10 / SO2GBIII10	N500GB5.4KS	NSM8XS	5 in 1- Build in	3rd WiFi BG	N	6CELL2.2	90W	Russian (KB.I170A.048)	Continental
AS7740G-334G50Mi	EMEA	Russia	AS7740G-334G50Mi W7HP64RUATRU1 MC MADISON_PRO1GBCbK_V3 2*2G/500_L/6L2.2/5R/ CB_bgn_0.3D_HG_RU11	Ci3330M	MADISON_PRO	1G-DDR3 (64*16*8)	SO4GBIII10 / SO2GBIII10	N500GB5.4KS	NSM8XS	5 in 1- Build in	3rd WiFi BG	N	6CELL2.2	90W	Russian (KB.I170A.048)	Continental
AS7740G-336G50Mn	EMEA	Middle East	AS7740G-336G50Mn EM W7HP64EMATME4 MC MADISON_PRO1GBCbK_V3 4G+2G/500_L/6L2.2/5R/ CB_bgn_0.3D_HG_RU61	Ci3330M	MADISON_PRO	1G-DDR3 (64*16*8)	SO4GBIII10 / SO2GBIII10	N500GB5.4KS	NSM8XS	5 in 1- Build in	3rd WiFi 2x2 BGN	N	6CELL2.2	90W	Russian (KB.I170A.048)	Continental
AS7740G-334G50Mn	EMEA	Middle East	AS7740G-334G50Mn EM W7HP64EMATME4 MC MADISON_PRO1GBCbK_V3 2*2G/500_L/6L2.2/5R/ CB_bgn_0.3D_HG_RU61	Ci3330M	MADISON_PRO	1G-DDR3 (64*16*8)	SO4GBIII10 / SO2GBIII10	N500GB5.4KS	NSM8XS	5 in 1- Build in	3rd WiFi 2x2 BGN	N	6CELL2.2	90W	Russian (KB.I170A.048)	Continental
AS7740G-336G50Mn	EMEA	Middle East	AS7740G-336G50Mn EM W7HP64EMATME4 MC MADISON_PRO1GBCbK_V3 4G+2G/500_L/6L2.2/5R/ CB_bgn_0.3D_HG_ES61	Ci3330M	MADISON_PRO	1G-DDR3 (64*16*8)	SO4GBIII10 / SO2GBIII10	N500GB5.4KS	NSM8XS	5 in 1- Build in	3rd WiFi 2x2 BGN	N	6CELL2.2	90W	Russian (KB.I170A.048)	Continental
AS7740G-336G50Mn	EMEA	Turkey	AS7740G-336G50Mn EM W7HP64EMATTR1 MC MADISON_PRO1GBCbK_V3 4G+2G/500_L/6L2.2/5R/ CB_bgn_0.3D_HG_TR31	Ci3330M	MADISON_PRO	1G-DDR3 (64*16*8)	SO4GBIII10 / SO2GBIII10	N500GB5.4KS	NSM8XS	5 in 1- Build in	3rd WiFi 2x2 BGN	N	6CELL2.2	90W	Turkish (KB.I170A.054)	Continental
AS7740G-334G50Mn	EMEA	Turkey	AS7740G-334G50Mn EM W7HP64EMATTR1 MC MADISON_PRO1GBCbK_V3 2*2G/500_L/6L2.2/5R/ CB_bgn_0.3D_HG_TR31	Ci3330M	MADISON_PRO	1G-DDR3 (64*16*8)	SO4GBIII10 / SO2GBIII10	N500GB5.4KS	NSM8XS	5 in 1- Build in	3rd WiFi 2x2 BGN	N	6CELL2.2	90W	Turkish (KB.I170A.054)	Continental

AS7740G-336G50Mn	EMEA	Belgium	AS7740G-336G50Mn W7HP64ATBE1 MC MADISON_PRO1GBcBk_V3 4G+2G/500_L/6L2.2/5R/ CB_bgn_0_3D_HG_NL11	Ci3330M	MADISON_PRO	1G-DDR3 (64*16*8)	SO4GBIII10 / SO2GBIII10	N500GB5.4KS	NSM8XS	5 in 1- Build in	3rd WiFi 2x2 BGN	N	6CELL2.2	90W	Belgium (KB.I170A.033)	Continental
AS7740G-336G50Mn	EMEA	Middle East	AS7740G-336G50Mn EM W7HP64EMATME2 MC MADISON_PRO1GBcBk_V3 4G+2G/500_L/6L2.2/5R/ CB_bgn_0_3D_HG_ES61	Ci3330M	MADISON_PRO	1G-DDR3 (64*16*8)	SO4GBIII10 / SO2GBIII10	N500GB5.4KS	NSM8XS	5 in 1- Build in	3rd WiFi 2x2 BGN	N	6CELL2.2	90W	Arabic (KB.I170A.032)	UK and US- 110V
AS7740G-336G50Mn	EMEA	Middle East	AS7740G-336G50Mn EM W7HP64EMATME2 MC MADISON_PRO1GBcBk_V3 4G+2G/500_L/6L2.2/5R/ CB_bgn_0_3D_HG_AR21	Ci3330M	MADISON_PRO	1G-DDR3 (64*16*8)	SO4GBIII10 / SO2GBIII10	N500GB5.4KS	NSM8XS	5 in 1- Build in	3rd WiFi 2x2 BGN	N	6CELL2.2	90W	Arabic (KB.I170A.032)	UK and US- 110V
AS7740G-336G50Mn	EMEA	Middle East	AS7740G-336G50Mn EM W7HP64EMATME2 MC MADISON_PRO1GBcBk_V3 4G+2G/500_L/6L2.2/5R/ CB_bgn_0_3D_HG_AR11	Ci3330M	MADISON_PRO	1G-DDR3 (64*16*8)	SO4GBIII10 / SO2GBIII10	N500GB5.4KS	NSM8XS	5 in 1- Build in	3rd WiFi 2x2 BGN	N	6CELL2.2	90W	Arabic (KB.I170A.032)	UK and US- 110V
AS7740G-334G50Mn	EMEA	Middle East	AS7740G-334G50Mn EM W7HP64EMATME2 MC MADISON_PRO1GBcBk_V3 2*2G/500_L/6L2.2/5R/ CB_bgn_0_3D_HG_ES61	Ci3330M	MADISON_PRO	1G-DDR3 (64*16*8)	SO4GBIII10 / SO2GBIII10	N500GB5.4KS	NSM8XS	5 in 1- Build in	3rd WiFi 2x2 BGN	N	6CELL2.2	90W	Arabic (KB.I170A.032)	UK and US- 110V
AS7740G-336G50Mn	EMEA	Italy	AS7740G-336G50Mn W7HP64ATIT1 MC MADISON_PRO1GBcBk_V3 4G+2G/500_L/6L2.2/5R/ CB_bgn_0_3D_HG_IT11	Ci3330M	MADISON_PRO	1G-DDR3 (64*16*8)	SO4GBIII10 / SO2GBIII10	N500GB5.4KS	NSM8XS	5 in 1- Build in	3rd WiFi 2x2 BGN	N	6CELL2.2	90W	Italian (KB.I170A.043)	Italian
AS7740G-336G50Mn	EMEA	Hungary	AS7740G-336G50Mn W7HP64ATHU1 MC MADISON_PRO1GBcBk_V3 4G+2G/500_L/6L2.2/5R/ CB_bgn_0_3D_HG_HU11	Ci3330M	MADISON_PRO	1G-DDR3 (64*16*8)	SO4GBIII10 / SO2GBIII10	N500GB5.4KS	NSM8XS	5 in 1- Build in	3rd WiFi 2x2 BGN	N	6CELL2.2	90W	Hungarian (KB.I170A.042)	Continental
AS7740G-336G50Mn	EMEA	Middle East	AS7740G-336G50Mn EM W7HP64EMATME6 MC MADISON_PRO1GBcBk_V3 4G+2G/500_L/6L2.2/5R/ CB_bgn_0_3D_HG_ES61	Ci3330M	MADISON_PRO	1G-DDR3 (64*16*8)	SO4GBIII10 / SO2GBIII10	N500GB5.4KS	NSM8XS	5 in 1- Build in	3rd WiFi 2x2 BGN	N	6CELL2.2	90W	US International (KB.I170A.056)	UK
AS7740G-336G50Mn	EMEA	South Africa	AS7740G-336G50Mn EM W7HP64EMATZA4 MC MADISON_PRO1GBcBk_V3 4G+2G/500_L/6L2.2/5R/ CB_bgn_0_3D_HG_ES61	Ci3330M	MADISON_PRO	1G-DDR3 (64*16*8)	SO4GBIII10 / SO2GBIII10	N500GB5.4KS	NSM8XS	5 in 1- Build in	3rd WiFi 2x2 BGN	N	6CELL2.2	90W	US International (KB.I170A.056)	UK
AS7740G-336G50Mn	EMEA	South Africa	AS7740G-336G50Mn EM W7HP64EMATZA2 MC MADISON_PRO1GBcBk_V3 4G+2G/500_L/6L2.2/5R/ CB_bgn_0_3D_HG_ES61	Ci3330M	MADISON_PRO	1G-DDR3 (64*16*8)	SO4GBIII10 / SO2GBIII10	N500GB5.4KS	NSM8XS	5 in 1- Build in	3rd WiFi 2x2 BGN	N	6CELL2.2	90W	US International (KB.I170A.056)	AF
AS7740G-628G64Bn	EMEA	Holland	AS7740G-628G64Bn W7HP64ATNL1 MC MADISON_PRO1GBcBk_V3 2*4G/640/BT/6L2.2/5R/ CB_bgn_0_3D_HG_NL11	Ci7620M	MADISON_PRO	1G-DDR3 (64*16*8)	SO4GBIII10	N640GB5.4KS	NBDCB4XS	5 in 1- Build in	3rd WiFi 2x2 BGN	BT 2.1	6CELL2.2	90W	US International (KB.I170A.056)	Continental
AS7740G-628G64Bn	EMEA	Luxembourg	AS7740G-628G64Bn W7HP64ATLU3 MC MADISON_PRO1GBcBk_V3 2*4G/640/BT/6L2.2/5R/ CB_bgn_0_3D_HG_IT41	Ci7620M	MADISON_PRO	1G-DDR3 (64*16*8)	SO4GBIII10	N640GB5.4KS	NBDCB4XS	5 in 1- Build in	3rd WiFi 2x2 BGN	BT 2.1	6CELL2.2	90W	Swiss/G (KB.I170A.052)	Continental
AS7740G-628G64Bn	EMEA	Belgium	AS7740G-628G64Bn W7HP64ATBE1 MC MADISON_PRO1GBcBk_V3 2*4G/640/BT/6L2.2/5R/ CB_bgn_0_3D_HG_NL11	Ci7620M	MADISON_PRO	1G-DDR3 (64*16*8)	SO4GBIII10	N640GB5.4KS	NBDCB4XS	5 in 1- Build in	3rd WiFi 2x2 BGN	BT 2.1	6CELL2.2	90W	Belgium (KB.I170A.033)	Continental
AS7740G-438G64Mn	EMEA	Holland	AS7740G-438G64Mn W7HP64ATNL1 MC MADISON_PRO1GBcBk_V3 2*4G/640/BT/6L2.2/5R/ CB_bgn_0_3D_HG_NL11	Ci5430M	MADISON_PRO	1G-DDR3 (64*16*8)	SO4GBIII10	N640GB5.4KS	NSM8XS	5 in 1- Build in	3rd WiFi 2x2 BGN	BT 2.1	6CELL2.2	90W	US International (KB.I170A.056)	Continental
AS7740G-438G64Mn	EMEA	Luxembourg	AS7740G-438G64Mn W7HP64ATLU3 MC MADISON_PRO1GBcBk_V3 2*4G/640/BT/6L2.2/5R/ CB_bgn_0_3D_HG_IT41	Ci5430M	MADISON_PRO	1G-DDR3 (64*16*8)	SO4GBIII10	N640GB5.4KS	NSM8XS	5 in 1- Build in	3rd WiFi 2x2 BGN	BT 2.1	6CELL2.2	90W	Swiss/G (KB.I170A.052)	Continental
AS7740G-438G64Mn	EMEA	Belgium	AS7740G-438G64Mn W7HP64ATBE1 MC MADISON_PRO1GBcBk_V3 2*4G/640/BT/6L2.2/5R/ CB_bgn_0_3D_HG_NL11	Ci5430M	MADISON_PRO	1G-DDR3 (64*16*8)	SO4GBIII10	N640GB5.4KS	NSM8XS	5 in 1- Build in	3rd WiFi 2x2 BGN	BT 2.1	6CELL2.2	90W	Belgium (KB.I170A.033)	Continental
AS7740G-334G64Mn	EMEA	Holland	AS7740G-334G64Mn W7HP64ATNL1 MC MADISON_PRO1GBcBk_V3 2*2G/640/6L2.2/5R/ CB_bgn_0_3D_HG_NL11	Ci3330M	MADISON_PRO	1G-DDR3 (64*16*8)	SO2GBIII10	N640GB5.4KS	NSM8XS	5 in 1- Build in	3rd WiFi 2x2 BGN	N	6CELL2.2	90W	US International (KB.I170A.056)	Continental
AS7740G-334G64Mn	EMEA	Luxembourg	AS7740G-334G64Mn W7HP64ATLU3 MC MADISON_PRO1GBcBk_V3 2*2G/640/6L2.2/5R/ CB_bgn_0_3D_HG_IT41	Ci3330M	MADISON_PRO	1G-DDR3 (64*16*8)	SO2GBIII10	N640GB5.4KS	NSM8XS	5 in 1- Build in	3rd WiFi 2x2 BGN	N	6CELL2.2	90W	Swiss/G (KB.I170A.052)	Continental
AS7740G-334G64Mn	EMEA	Belgium	AS7740G-334G64Mn W7HP64ATBE1 MC MADISON_PRO1GBcBk_V3 2*2G/640/6L2.2/5R/ CB_bgn_0_3D_HG_NL11	Ci3330M	MADISON_PRO	1G-DDR3 (64*16*8)	SO2GBIII10	N640GB5.4KS	NSM8XS	5 in 1- Build in	3rd WiFi 2x2 BGN	N	6CELL2.2	90W	Belgium (KB.I170A.033)	Continental
AS7740G-434G50Mn	EMEA	South Africa	AS7740G-434G50Mn EM W7HP64EMATZA2 MC MADISON_PRO1GBcBk_V3 2*2G/500_L/BT/6L2.2/5R/ CB_bgn_0_3D_HG_ES61	Ci5430M	MADISON_PRO	1G-DDR3 (64*16*8)	SO2GBIII10	N500GB5.4KS	NSM8XS	5 in 1- Build in	3rd WiFi 2x2 BGN	BT 2.1	6CELL2.2	90W	US International (KB.I170A.056)	AF
AS7740G-334G50Mn	EMEA	Middle East	AS7740G-334G50Mn EM W7HP64EMATME2 MC MADISON_PRO1GBcBk_V3 2*2G/500_L/6L2.2/5R/ CB_bgn_0_3D_HG_AR11	Ci3330M	MADISON_PRO	1G-DDR3 (64*16*8)	SO2GBIII10	N500GB5.4KS	NSM8XS	5 in 1- Build in	3rd WiFi 2x2 BGN	N	6CELL2.2	90W	Arabic (KB.I170A.032)	UK and US- 110V

AS7740G-334G50Mn	EMEA	France	AS7740G-334G50Mn W7HP64ATFR1 MC MADISON_PRO1GBCbk_V3 2*2G/500_L/6L2.2/5R/ CB_bgn_0.3D_HG_FR21	Ci3330M	MADISON_PRO	1G-DDR3 (64*16*8)	SO2GBIII10	N500GB5.4KS	NSM8XS	5 in 1- Build in	3rd WiFi 2x2 BGN	N	6CELL2.2	90W	French (KB.I170A.039)	Continental
AS7740G-334G50Mn	EMEA	Middle East	AS7740G-334G50Mn EM W7HP64EMATME3 MC MADISON_PRO1GBCbk_V3 2*2G/500_L/6L2.2/5R/ CB_bgn_0.3D_HG_ES81	Ci3330M	MADISON_PRO	1G-DDR3 (64*16*8)	SO2GBIII10	N500GB5.4KS	NSM8XS	5 in 1- Build in	3rd WiFi 2x2 BGN	N	6CELL2.2	90W	French (KB.I170A.039)	Continental
AS7740G-334G50Mn	EMEA	Holland	AS7740G-334G50Mn W7HP64ATNL1 MC MADISON_PRO1GBCbk_V3 2*2G/500_L/6L2.2/5R/ CB_bgn_0.3D_HG_NL11	Ci3330M	MADISON_PRO	1G-DDR3 (64*16*8)	SO2GBIII10	N500GB5.4KS	NSM8XS	5 in 1- Build in	3rd WiFi 2x2 BGN	N	6CELL2.2	90W	US International (KB.I170A.056)	Continental
AS7740G-334G50Mn	EMEA	Poland	AS7740G-334G50Mn W7HP64ATPL1 MC MADISON_PRO1GBCbk_V3 2*2G/500_L/6L2.2/5R/ CB_bgn_0.3D_HG_PL11	Ci3330M	MADISON_PRO	1G-DDR3 (64*16*8)	SO2GBIII10	N500GB5.4KS	NSM8XS	5 in 1- Build in	3rd WiFi 2x2 BGN	N	6CELL2.2	90W	US International (KB.I170A.056)	Continental
AS7740G-334G50Mn	EMEA	South Africa	AS7740G-334G50Mn EM W7HP64EMATZA4 MC MADISON_PRO1GBCbk_V3 2*2G/500_L/6L2.2/5R/ CB_bgn_0.3D_HG_ES61	Ci3330M	MADISON_PRO	1G-DDR3 (64*16*8)	SO2GBIII10	N500GB5.4KS	NSM8XS	5 in 1- Build in	3rd WiFi 2x2 BGN	N	6CELL2.2	90W	US International (KB.I170A.056)	UK
AS7740G-334G50Mn	EMEA	Middle East	AS7740G-334G50Mn EM W7HP64EMATME6 MC MADISON_PRO1GBCbk_V3 2*2G/500_L/6L2.2/5R/ CB_bgn_0.3D_HG_ES61	Ci3330M	MADISON_PRO	1G-DDR3 (64*16*8)	SO2GBIII10	N500GB5.4KS	NSM8XS	5 in 1- Build in	3rd WiFi 2x2 BGN	N	6CELL2.2	90W	US International (KB.I170A.056)	UK
AS7740G-334G50Mn	EMEA	Germany	AS7740G-334G50Mn W7HP64ATDE1 MC MADISON_PRO1GBCbk_V3 2*2G/500_L/6L2.2/5R/ CB_bgn_0.3D_HG_DE11	Ci3330M	MADISON_PRO	1G-DDR3 (64*16*8)	SO2GBIII10	N500GB5.4KS	NSM8XS	5 in 1- Build in	3rd WiFi 2x2 BGN	N	6CELL2.2	90W	German (KB.I170A.040)	Continental
AS7740G-334G50Mn	EMEA	Middle East	AS7740G-334G50Mn EM W7HP64EMATME2 MC MADISON_PRO1GBCbk_V3 2*2G/500_L/6L2.2/5R/ CB_bgn_0.3D_HG_AR21	Ci3330M	MADISON_PRO	1G-DDR3 (64*16*8)	SO2GBIII10	N500GB5.4KS	NSM8XS	5 in 1- Build in	3rd WiFi 2x2 BGN	N	6CELL2.2	90W	Arabic (KB.I170A.032)	UK and US-110V
AS7740G-334G50Mn	EMEA	Middle East	AS7740G-334G50Mn EM W7HP64EMATME4 MC MADISON_PRO1GBCbk_V3 2*2G/500_L/6L2.2/5R/ CB_bgn_0.3D_HG_ES61	Ci3330M	MADISON_PRO	1G-DDR3 (64*16*8)	SO2GBIII10	N500GB5.4KS	NSM8XS	5 in 1- Build in	3rd WiFi 2x2 BGN	N	6CELL2.2	90W	Russian (KB.I170A.048)	Continental
AS7740G-438G64Mi	EMEA	Russia	AS7740G-438G64Mi W7HP64RUATRU1 MC MADISON_PRO1GBCbk_V3 2*4G/640/6L2.2/5R/ CB_bgn_0.3D_HG_RU11	Ci5430M	MADISON_PRO	1G-DDR3 (64*16*8)	SO4GBIII10	N640GB5.4KS	NSM8XS	5 in 1- Build in	3rd WiFi BG	N	6CELL2.2	90W	Russian (KB.I170A.048)	Continental
AS7740G-434G64Mi	EMEA	Russia	AS7740G-434G64Mi W7HP64RUATRU1 MC MADISON_PRO1GBCbk_V3 2*2G/640/6L2.2/5R/ CB_bgn_0.3D_HG_RU11	Ci5430M	MADISON_PRO	1G-DDR3 (64*16*8)	SO2GBIII10	N640GB5.4KS	NSM8XS	5 in 1- Build in	3rd WiFi BG	N	6CELL2.2	90W	Russian (KB.I170A.048)	Continental
AS7740G-334G32Mi	EMEA	Russia	AS7740G-334G32Mi W7HP64RUATRU1 MC MADISON_PRO1GBCbk_V3 2*2G/320/BT/8L2.4/5R/ CB_bgn_0.3D_HG_RU11	Ci3330M	MADISON_PRO	1G-DDR3 (64*16*8)	SO2GBIII10	N320GB5.4KS	NSM8XS	5 in 1- Build in	3rd WiFi BG	BT 2.1	8CELL2.4	90W	Russian (KB.I170A.048)	Continental
AS7740G-434G50Mi	EMEA	Russia	AS7740G-434G50Mi W7HP64RUATRU1 MC MADISON_PRO1GBCbk_V3 2*2G/500_L/BT/8L2.4/5R/ CB_bgn_0.3D_HG_RU11	Ci5430M	MADISON_PRO	1G-DDR3 (64*16*8)	SO2GBIII10	N500GB5.4KS	NSM8XS	5 in 1- Build in	3rd WiFi BG	BT 2.1	8CELL2.4	90W	Russian (KB.I170A.048)	Continental
AS7740G-334G50Mi	EMEA	Russia	AS7740G-334G50Mi W7HP64RUATRU1 MC MADISON_PRO1GBCbk_V3 2*2G/500_L/8L2.4/5R/ CB_bgn_0.3D_HG_RU11	Ci3330M	MADISON_PRO	1G-DDR3 (64*16*8)	SO2GBIII10	N500GB5.4KS	NSM8XS	5 in 1- Build in	3rd WiFi BG	N	8CELL2.4	90W	Russian (KB.I170A.048)	Continental
AS7740G-626G50Mi	EMEA	Russia	AS7740G-626G50Mi W7HP64RUATRU1 MC MADISON_PRO1GBCbk_V3 4G+2G/500_L/8L2.4/5R/ CB_bgn_0.3D_HG_RU11	Ci7620M	MADISON_PRO	1G-DDR3 (64*16*8)	SO4GBIII10 / SO2GBIII10	N500GB5.4KS	NSM8XS	5 in 1- Build in	3rd WiFi BG	N	8CELL2.4	90W	Russian (KB.I170A.048)	Continental
AS7740G-334G50Mn	EMEA	Latvia	AS7740G-334G50Mn W7HP64ATLV1 MC MADISON_PRO1GBCbk_V3 2*2G/500_L/8L2.4/5R/ CB_bgn_0.3D_HG_RU22	Ci3330M	MADISON_PRO	1G-DDR3 (64*16*8)	SO2GBIII10	N500GB5.4KS	NSM8XS	5 in 1- Build in	3rd WiFi 2x2 BGN	N	8CELL2.4	90W	Russian (KB.I170A.048)	Continental
AS7740G-334G50Mn	EMEA	Latvia	AS7740G-334G50Mn W7HP64ATLV1 MC MADISON_PRO1GBCbk_V3 2*2G/500_L/6L2.2/5R/ CB_bgn_0.3D_HG_RU22	Ci3330M	MADISON_PRO	1G-DDR3 (64*16*8)	SO2GBIII10	N500GB5.4KS	NSM8XS	5 in 1- Build in	3rd WiFi 2x2 BGN	N	6CELL2.2	90W	Russian (KB.I170A.048)	Continental
AS7740G-334G50Mn	EMEA	Belgium	AS7740G-334G50Mn W7HP64ATBE1 MC MADISON_PRO1GBCbk_V3 2*2G/500_L/8L2.4/5R/ CB_bgn_0.3D_HG_NL11	Ci3330M	MADISON_PRO	1G-DDR3 (64*16*8)	SO2GBIII10	N500GB5.4KS	NSM8XS	5 in 1- Build in	3rd WiFi 2x2 BGN	N	8CELL2.4	90W	Belgium (KB.I170A.033)	Continental
AS7740G-334G50Mn	EMEA	Belgium	AS7740G-334G50Mn W7HP64ATBE1 MC MADISON_PRO1GBCbk_V3 2*2G/500_L/6L2.2/5R/ CB_bgn_0.3D_HG_NL11	Ci3330M	MADISON_PRO	1G-DDR3 (64*16*8)	SO2GBIII10	N500GB5.4KS	NSM8XS	5 in 1- Build in	3rd WiFi 2x2 BGN	N	6CELL2.2	90W	Belgium (KB.I170A.033)	Continental
AS7740G-334G50Mn	EMEA	Italy	AS7740G-334G50Mn W7HP64ATIT1 MC MADISON_PRO1GBCbk_V3 2*2G/500_L/8L2.4/5R/ CB_bgn_0.3D_HG_IT11	Ci3330M	MADISON_PRO	1G-DDR3 (64*16*8)	SO2GBIII10	N500GB5.4KS	NSM8XS	5 in 1- Build in	3rd WiFi 2x2 BGN	N	8CELL2.4	90W	Italian (KB.I170A.043)	Italian
AS7740G-334G50Mn	EMEA	Italy	AS7740G-334G50Mn W7HP64ATIT1 MC MADISON_PRO1GBCbk_V3 2*2G/500_L/6L2.2/5R/ CB_bgn_0.3D_HG_IT11	Ci3330M	MADISON_PRO	1G-DDR3 (64*16*8)	SO2GBIII10	N500GB5.4KS	NSM8XS	5 in 1- Build in	3rd WiFi 2x2 BGN	N	6CELL2.2	90W	Italian (KB.I170A.043)	Italian

AS7740G-334G50Mn	EMEA	Hungary	AS7740G-334G50Mn W7HP64ATHU1 MC MADISON_PRO1GBcBk_V3 2*2G/500_L/8L2.4/5R/ CB_bgn_0_3D_HG_HU11	Ci3330M	MADISON_PRO	1G-DDR3 (64*16*8)	SO2GBIII10	N500GB5.4KS	NSM8XS	5 in 1- Build in	3rd WiFi 2x2 BGN	N	8CELL2.4	90W	Hungarian (KB.I170A.042)	Continental
AS7740G-334G50Mn	EMEA	Hungary	AS7740G-334G50Mn W7HP64ATHU1 MC MADISON_PRO1GBcBk_V3 2*2G/500_L/6L2.2/5R/ CB_bgn_0_3D_HG_HU11	Ci3330M	MADISON_PRO	1G-DDR3 (64*16*8)	SO2GBIII10	N500GB5.4KS	NSM8XS	5 in 1- Build in	3rd WiFi 2x2 BGN	N	6CELL2.2	90W	Hungarian (KB.I170A.042)	Continental
AS7740G-334G50Mn	EMEA	Poland	AS7740G-334G50Mn W7HP64ATPL1 MC MADISON_PRO1GBcBk_V3 2*2G/500_L/8L2.4/5R/ CB_bgn_0_3D_HG_PL11	Ci3330M	MADISON_PRO	1G-DDR3 (64*16*8)	SO2GBIII10	N500GB5.4KS	NSM8XS	5 in 1- Build in	3rd WiFi 2x2 BGN	N	8CELL2.4	90W	US International (KB.I170A.056)	Continental
AS7740G-334G50Mn	EMEA	Holland	AS7740G-334G50Mn W7HP64ATNL1 MC MADISON_PRO1GBcBk_V3 2*2G/500_L/8L2.4/5R/ CB_bgn_0_3D_HG_NL11	Ci3330M	MADISON_PRO	1G-DDR3 (64*16*8)	SO2GBIII10	N500GB5.4KS	NSM8XS	5 in 1- Build in	3rd WiFi 2x2 BGN	N	8CELL2.4	90W	US International (KB.I170A.056)	Continental
AS7740G-334G50Mn	EMEA	Eastern Europe	AS7740G-334G50Mn W7HP64ATEU5 MC MADISON_PRO1GBcBk_V3 2*2G/500_L/8L2.4/5R/ CB_bgn_0_3D_HG_RO11	Ci3330M	MADISON_PRO	1G-DDR3 (64*16*8)	SO2GBIII10	N500GB5.4KS	NSM8XS	5 in 1- Build in	3rd WiFi 2x2 BGN	N	8CELL2.4	90W	US International (KB.I170A.056)	Continental
AS7740G-334G50Mn	EMEA	Eastern Europe	AS7740G-334G50Mn W7HP64ATEU5 MC MADISON_PRO1GBcBk_V3 2*2G/500_L/8L2.4/5R/ CB_bgn_0_3D_HG_PL171	Ci3330M	MADISON_PRO	1G-DDR3 (64*16*8)	SO2GBIII10	N500GB5.4KS	NSM8XS	5 in 1- Build in	3rd WiFi 2x2 BGN	N	8CELL2.4	90W	US International (KB.I170A.056)	Continental
AS7740G-334G50Mn	EMEA	Eastern Europe	AS7740G-334G50Mn W7HP64ATEU5 MC MADISON_PRO1GBcBk_V3 2*2G/500_L/6L2.2/5R/ CB_bgn_0_3D_HG_RO11	Ci3330M	MADISON_PRO	1G-DDR3 (64*16*8)	SO2GBIII10	N500GB5.4KS	NSM8XS	5 in 1- Build in	3rd WiFi 2x2 BGN	N	6CELL2.2	90W	US International (KB.I170A.056)	Continental
AS7740G-334G50Mn	EMEA	Eastern Europe	AS7740G-334G50Mn W7HP64ATEU5 MC MADISON_PRO1GBcBk_V3 2*2G/500_L/6L2.2/5R/ CB_bgn_0_3D_HG_PL171	Ci3330M	MADISON_PRO	1G-DDR3 (64*16*8)	SO2GBIII10	N500GB5.4KS	NSM8XS	5 in 1- Build in	3rd WiFi 2x2 BGN	N	6CELL2.2	90W	US International (KB.I170A.056)	Continental
AS7740G-334G50Mn	EMEA	South Africa	AS7740G-334G50Mn EM W7HP64EMATZA1 MC MADISON_PRO1GBcBk_V3 2*2G/500_L/6L2.2/5R/ CB_bgn_0_3D_HG_ES81	Ci3330M	MADISON_PRO	1G-DDR3 (64*16*8)	SO2GBIII10	N500GB5.4KS	NSM8XS	5 in 1- Build in	3rd WiFi 2x2 BGN	N	6CELL2.2	90W	French (KB.I170A.039)	Continental
AS7740G-334G50Mn	EMEA	France	AS7740G-334G50Mn W7HP64ATFR1 MC MADISON_PRO1GBcBk_V3 2*2G/500_L/8L2.4/5R/ CB_bgn_0_3D_HG_FR21	Ci3330M	MADISON_PRO	1G-DDR3 (64*16*8)	SO2GBIII10	N500GB5.4KS	NSM8XS	5 in 1- Build in	3rd WiFi 2x2 BGN	N	8CELL2.4	90W	French (KB.I170A.039)	Continental
AS7740G-334G50Mn	EMEA	Portugal	AS7740G-334G50Mn W7HP64ATPT1 MC MADISON_PRO1GBcBk_V3 2*2G/500_L/8L2.4/5R/ CB_bgn_0_3D_HG_PT11	Ci3330M	MADISON_PRO	1G-DDR3 (64*16*8)	SO2GBIII10	N500GB5.4KS	NSM8XS	5 in 1- Build in	3rd WiFi 2x2 BGN	N	8CELL2.4	90W	Portuguese (KB.I170A.047)	Continental
AS7740G-334G50Mn	EMEA	Portugal	AS7740G-334G50Mn W7HP64ATPT1 MC MADISON_PRO1GBcBk_V3 2*2G/500_L/6L2.2/5R/ CB_bgn_0_3D_HG_PT11	Ci3330M	MADISON_PRO	1G-DDR3 (64*16*8)	SO2GBIII10	N500GB5.4KS	NSM8XS	5 in 1- Build in	3rd WiFi 2x2 BGN	N	6CELL2.2	90W	Portuguese (KB.I170A.047)	Continental
AS7740G-334G50Mn	EMEA	Middle East	AS7740G-334G50Mn EM W7HP64EMATME9 MC MADISON_PRO1GBcBk_V3 2*2G/500_L/6L2.2/5R/ CB_bgn_0_3D_HG_ES81	Ci3330M	MADISON_PRO	1G-DDR3 (64*16*8)	SO2GBIII10	N500GB5.4KS	NSM8XS	5 in 1- Build in	3rd WiFi 2x2 BGN	N	6CELL2.2	90W	FR/Arabic (KB.I170A.038)	Continental
AS7740G-334G50Mn	EMEA	Algeria	AS7740G-334G50Mn EM W7HP64EMATD21 MC MADISON_PRO1GBcBk_V3 2*2G/500_L/6L2.2/5R/ CB_bgn_0_3D_HG_ES81	Ci3330M	MADISON_PRO	1G-DDR3 (64*16*8)	SO2GBIII10	N500GB5.4KS	NSM8XS	5 in 1- Build in	3rd WiFi 2x2 BGN	N	6CELL2.2	90W	FR/Arabic (KB.I170A.038)	Continental
AS7740G-334G50Mn	EMEA	Israel	AS7740G-334G50Mn W7HP64ATIL1 MC MADISON_PRO1GBcBk_V3 2*2G/500_L/8L2.4/5R/ CB_bgn_0_3D_HG_HE11	Ci3330M	MADISON_PRO	1G-DDR3 (64*16*8)	SO2GBIII10	N500GB5.4KS	NSM8XS	5 in 1- Build in	3rd WiFi 2x2 BGN	N	8CELL2.4	90W	US International w/ Hebrew (KB.I170A.057)	Israel
AS7740G-334G50Mn	EMEA	Israel	AS7740G-334G50Mn W7HP64ATIL1 MC MADISON_PRO1GBcBk_V3 2*2G/500_L/6L2.2/5R/ CB_bgn_0_3D_HG_HE11	Ci3330M	MADISON_PRO	1G-DDR3 (64*16*8)	SO2GBIII10	N500GB5.4KS	NSM8XS	5 in 1- Build in	3rd WiFi 2x2 BGN	N	6CELL2.2	90W	US International w/ Hebrew (KB.I170A.057)	Israel
AS7740G-334G50Mn	EMEA	Greece	AS7740G-334G50Mn W7HP64ATGR1 MC MADISON_PRO1GBcBk_V3 2*2G/500_L/8L2.4/5R/ CB_bgn_0_3D_HG_EL31	Ci3330M	MADISON_PRO	1G-DDR3 (64*16*8)	SO2GBIII10	N500GB5.4KS	NSM8XS	5 in 1- Build in	3rd WiFi 2x2 BGN	N	8CELL2.4	90W	Greek (KB.I170A.041)	Continental
AS7740G-334G50Mn	EMEA	Greece	AS7740G-334G50Mn W7HP64ATGR1 MC MADISON_PRO1GBcBk_V3 2*2G/500_L/6L2.2/5R/ CB_bgn_0_3D_HG_EL31	Ci3330M	MADISON_PRO	1G-DDR3 (64*16*8)	SO2GBIII10	N500GB5.4KS	NSM8XS	5 in 1- Build in	3rd WiFi 2x2 BGN	N	6CELL2.2	90W	Greek (KB.I170A.041)	Continental
AS7740G-334G50Mn	EMEA	Eastern Europe	AS7740G-334G50Mn W7HP64ATEU4 MC MADISON_PRO1GBcBk_V3 2*2G/500_L/8L2.4/5R/ CB_bgn_0_3D_HG_SV21	Ci3330M	MADISON_PRO	1G-DDR3 (64*16*8)	SO2GBIII10	N500GB5.4KS	NSM8XS	5 in 1- Build in	3rd WiFi 2x2 BGN	N	8CELL2.4	90W	Sweden (KB.I170A.051)	Continental
AS7740G-334G50Mn	EMEA	Eastern Europe	AS7740G-334G50Mn W7HP64ATEU4 MC MADISON_PRO1GBcBk_V3 2*2G/500_L/6L2.2/5R/ CB_bgn_0_3D_HG_SV21	Ci3330M	MADISON_PRO	1G-DDR3 (64*16*8)	SO2GBIII10	N500GB5.4KS	NSM8XS	5 in 1- Build in	3rd WiFi 2x2 BGN	N	6CELL2.2	90W	Sweden (KB.I170A.051)	Continental
AS7740G-334G50Mn	EMEA	Luxembourg	AS7740G-334G50Mn W7HP64ATLU3 MC MADISON_PRO1GBcBk_V3 2*2G/500_L/8L2.4/5R/ CB_bgn_0_3D_HG_IT41	Ci3330M	MADISON_PRO	1G-DDR3 (64*16*8)	SO2GBIII10	N500GB5.4KS	NSM8XS	5 in 1- Build in	3rd WiFi 2x2 BGN	N	8CELL2.4	90W	Swiss/G (KB.I170A.052)	Continental

AS7740G-334G50Mn	EMEA	Luxembourg	AS7740G-334G50Mn W7HP64ATLU3 MC MADISON_PRO1GBCbK_V3 2*2G/500_L/8L2.2/5R/ CB_bgn_0.3D_HG_IT41	Ci3330M	MADISON_PRO	1G-DDR3 (64*16*8)	SO2GBIII10	N500GB5.4KS	NSM8XS	5 in 1- Build in	3rd WiFi 2x2 BGN	N	6CELL2.2	90W	Swiss/G (KB.1170A.052)	Continental
AS7740G-334G50Mn	EMEA	Switzerland	AS7740G-334G50Mn W7HP64ATCH1 MC MADISON_PRO1GBCbK_V3 2*2G/500_L/8L2.4/5R/ CB_bgn_0.3D_HG_IT41	Ci3330M	MADISON_PRO	1G-DDR3 (64*16*8)	SO2GBIII10	N500GB5.4KS	NSM8XS	5 in 1- Build in	3rd WiFi 2x2 BGN	N	8CELL2.4	90W	Swiss/G (KB.1170A.052)	Swiss
AS7740G-334G50Mn	EMEA	Switzerland	AS7740G-334G50Mn W7HP64ATCH1 MC MADISON_PRO1GBCbK_V3 2*2G/500_L/6L2.2/5R/ CB_bgn_0.3D_HG_IT41	Ci3330M	MADISON_PRO	1G-DDR3 (64*16*8)	SO2GBIII10	N500GB5.4KS	NSM8XS	5 in 1- Build in	3rd WiFi 2x2 BGN	N	6CELL2.2	90W	Swiss/G (KB.1170A.052)	Swiss
AS7740G-334G50Mn	EMEA	Germany	AS7740G-334G50Mn W7HP64ATDE1 MC MADISON_PRO1GBCbK_V3 2*2G/500_L/8L2.4/5R/ CB_bgn_0.3D_HG_DE11	Ci3330M	MADISON_PRO	1G-DDR3 (64*16*8)	SO2GBIII10	N500GB5.4KS	NSM8XS	5 in 1- Build in	3rd WiFi 2x2 BGN	N	8CELL2.4	90W	German (KB.1170A.040)	Continental
AS7740G-334G50Mn	EMEA	Austria	AS7740G-334G50Mn W7HP64ATAT1 MC MADISON_PRO1GBCbK_V3 2*2G/500_L/8L2.4/5R/ CB_bgn_0.3D_HG_DE61	Ci3330M	MADISON_PRO	1G-DDR3 (64*16*8)	SO2GBIII10	N500GB5.4KS	NSM8XS	5 in 1- Build in	3rd WiFi 2x2 BGN	N	8CELL2.4	90W	German (KB.1170A.040)	Continental
AS7740G-334G50Mn	EMEA	Austria	AS7740G-334G50Mn W7HP64ATAT1 MC MADISON_PRO1GBCbK_V3 2*2G/500_L/6L2.2/5R/ CB_bgn_0.3D_HG_DE61	Ci3330M	MADISON_PRO	1G-DDR3 (64*16*8)	SO2GBIII10	N500GB5.4KS	NSM8XS	5 in 1- Build in	3rd WiFi 2x2 BGN	N	6CELL2.2	90W	German (KB.1170A.040)	Continental
AS7740G-334G50Mn	EMEA	Denmark	AS7740G-334G50Mn W7HP64ATDK2 MC MADISON_PRO1GBCbK_V3 2*2G/500_L/8L2.4/5R/ CB_bgn_0.3D_HG_ENS1	Ci3330M	MADISON_PRO	1G-DDR3 (64*16*8)	SO2GBIII10	N500GB5.4KS	NSM8XS	5 in 1- Build in	3rd WiFi 2x2 BGN	N	8CELL2.4	90W	Nordic (KB.1170A.045)	Danish/ Continental
AS7740G-334G50Mn	EMEA	Denmark	AS7740G-334G50Mn W7HP64ATDK2 MC MADISON_PRO1GBCbK_V3 2*2G/500_L/6L2.2/5R/ CB_bgn_0.3D_HG_ENS1	Ci3330M	MADISON_PRO	1G-DDR3 (64*16*8)	SO2GBIII10	N500GB5.4KS	NSM8XS	5 in 1- Build in	3rd WiFi 2x2 BGN	N	6CELL2.2	90W	Nordic (KB.1170A.045)	Danish/ Continental
AS7740G-334G50Mn	EMEA	Serbia/ Macedonia	AS7740G-334G50Mn W7HP64ATCS1 MC MADISON_PRO1GBCbK_V3 2*2G/500_L/8L2.4/5R/ CB_bgn_0.3D_HG_SL11	Ci3330M	MADISON_PRO	1G-DDR3 (64*16*8)	SO2GBIII10	N500GB5.4KS	NSM8XS	5 in 1- Build in	3rd WiFi 2x2 BGN	N	8CELL2.4	90W	SLO/CRO (KB.1170A.049)	Continental
AS7740G-334G50Mn	EMEA	Eastern Europe	AS7740G-334G50Mn W7HP64ATEU7 MC MADISON_PRO1GBCbK_V3 2*2G/500_L/8L2.4/5R/ CB_bgn_0.3D_HG_ENQ1	Ci3330M	MADISON_PRO	1G-DDR3 (64*16*8)	SO2GBIII10	N500GB5.4KS	NSM8XS	5 in 1- Build in	3rd WiFi 2x2 BGN	N	8CELL2.4	90W	SLO/CRO (KB.1170A.049)	Continental
AS7740G-334G50Mn	EMEA	Eastern Europe	AS7740G-334G50Mn W7HP64ATEU7 MC MADISON_PRO1GBCbK_V3 2*2G/500_L/8L2.4/5R/ CB_bgn_0.3D_HG_SL11	Ci3330M	MADISON_PRO	1G-DDR3 (64*16*8)	SO2GBIII10	N500GB5.4KS	NSM8XS	5 in 1- Build in	3rd WiFi 2x2 BGN	N	8CELL2.4	90W	SLO/CRO (KB.1170A.049)	Continental
AS7740G-334G50Mn	EMEA	Serbia/ Macedonia	AS7740G-334G50Mn W7HP64ATCS1 MC MADISON_PRO1GBCbK_V3 2*2G/500_L/6L2.2/5R/ CB_bgn_0.3D_HG_SL11	Ci3330M	MADISON_PRO	1G-DDR3 (64*16*8)	SO2GBIII10	N500GB5.4KS	NSM8XS	5 in 1- Build in	3rd WiFi 2x2 BGN	N	6CELL2.2	90W	SLO/CRO (KB.1170A.049)	Continental
AS7740G-334G50Mn	EMEA	Eastern Europe	AS7740G-334G50Mn W7HP64ATEU7 MC MADISON_PRO1GBCbK_V3 2*2G/500_L/6L2.2/5R/ CB_bgn_0.3D_HG_ENQ1	Ci3330M	MADISON_PRO	1G-DDR3 (64*16*8)	SO2GBIII10	N500GB5.4KS	NSM8XS	5 in 1- Build in	3rd WiFi 2x2 BGN	N	6CELL2.2	90W	SLO/CRO (KB.1170A.049)	Continental
AS7740G-334G50Mn	EMEA	Eastern Europe	AS7740G-334G50Mn W7HP64ATEU7 MC MADISON_PRO1GBCbK_V3 2*2G/500_L/8L2.2/5R/ CB_bgn_0.3D_HG_SL11	Ci3330M	MADISON_PRO	1G-DDR3 (64*16*8)	SO2GBIII10	N500GB5.4KS	NSM8XS	5 in 1- Build in	3rd WiFi 2x2 BGN	N	6CELL2.2	90W	SLO/CRO (KB.1170A.049)	Continental
AS7740G-334G50Mn	EMEA	Czech	AS7740G-334G50Mn W7HP64ATCZ2 MC MADISON_PRO1GBCbK_V3 2*2G/500_L/8L2.4/5R/ CB_bgn_0.3D_HG_SK11	Ci3330M	MADISON_PRO	1G-DDR3 (64*16*8)	SO2GBIII10	N500GB5.4KS	NSM8XS	5 in 1- Build in	3rd WiFi 2x2 BGN	N	8CELL2.4	90W	CZ/SK (KB.1170A.035)	Continental
AS7740G-334G50Mn	EMEA	Czech	AS7740G-334G50Mn W7HP64ATCZ2 MC MADISON_PRO1GBCbK_V3 2*2G/500_L/6L2.2/5R/ CB_bgn_0.3D_HG_SK11	Ci3330M	MADISON_PRO	1G-DDR3 (64*16*8)	SO2GBIII10	N500GB5.4KS	NSM8XS	5 in 1- Build in	3rd WiFi 2x2 BGN	N	6CELL2.2	90W	CZ/SK (KB.1170A.035)	Continental
AS7740G-334G50Mn	EMEA	Spain	AS7740G-334G50Mn W7HP64ATES1 MC MADISON_PRO1GBCbK_V3 2*2G/500_L/8L2.4/5R/ CB_bgn_0.3D_HG_ES51	Ci3330M	MADISON_PRO	1G-DDR3 (64*16*8)	SO2GBIII10	N500GB5.4KS	NSM8XS	5 in 1- Build in	3rd WiFi 2x2 BGN	N	8CELL2.4	90W	Spanish (KB.1170A.050)	Continental
AS7740G-334G50Mn	EMEA	Spain	AS7740G-334G50Mn W7HP64ATES1 MC MADISON_PRO1GBCbK_V3 2*2G/500_L/6L2.2/5R/ CB_bgn_0.3D_HG_ES51	Ci3330M	MADISON_PRO	1G-DDR3 (64*16*8)	SO2GBIII10	N500GB5.4KS	NSM8XS	5 in 1- Build in	3rd WiFi 2x2 BGN	N	6CELL2.2	90W	Spanish (KB.1170A.050)	Continental
AS7740G-334G50Mn	EMEA	UK	AS7740G-334G50Mn W7HP64ATGB1 MC MADISON_PRO1GBCbK_V3 2*2G/500_L/8L2.4/5R/ CB_bgn_0.3D_HG_EN11	Ci3330M	MADISON_PRO	1G-DDR3 (64*16*8)	SO2GBIII10	N500GB5.4KS	NSM8XS	5 in 1- Build in	3rd WiFi 2x2 BGN	N	8CELL2.4	90W	UK (KB.1170A.055)	UK
AS7740G-334G50Mn	EMEA	Cyprus	AS7740G-334G50Mn W7HP64ATCY1 MC MADISON_PRO1GBCbK_V3 2*2G/500_L/8L2.4/5R/ CB_bgn_0.3D_HG_ES61	Ci3330M	MADISON_PRO	1G-DDR3 (64*16*8)	SO2GBIII10	N500GB5.4KS	NSM8XS	5 in 1- Build in	3rd WiFi 2x2 BGN	N	8CELL2.4	90W	UK (KB.1170A.055)	UK
AS7740G-334G50Mn	EMEA	UK	AS7740G-334G50Mn W7HP64ATGB1 MC MADISON_PRO1GBCbK_V3 2*2G/500_L/6L2.2/5R/ CB_bgn_0.3D_HG_EN11	Ci3330M	MADISON_PRO	1G-DDR3 (64*16*8)	SO2GBIII10	N500GB5.4KS	NSM8XS	5 in 1- Build in	3rd WiFi 2x2 BGN	N	6CELL2.2	90W	UK (KB.1170A.055)	UK

AS7740G-334G50Mn	EMEA	Cyprus	AS7740G-334G50Mn W7HP64ATCY1 MC MADISON_PRO1GBCbK_V3 2*2G/500_L/8L2.2/5R/ CB_bgn_0_3D_HG_ES61	Ci3330M	MADISON_PRO	1G-DDR3 (64*16*8)	SO2GBIII10	N500GB5.4KS	NSM8XS	5 in 1- Build in	3rd WiFi 2x2 BGN	N	6CELL2.2	90W	UK (KB.I170A.055)	UK
AS7740G-628G648n	AAP	Australia/New Zealand	AS7740G-628G648n W7HP64ATAU1 MC MADISON_PRO1GBCbK_V3 2*4G/640/BT/8L2.4/5R/ CB_bgn_0_3D_HG_ES61	Ci7620M	MADISON_PRO	1G-DDR3 (64*16*8)	SO4GBIII10	N640GB5.4KS	NBDCB4XS	5 in 1- Build in	3rd WiFi 2x2 BGN	BT 2.1	8CELL2.4	90W	US International (KB.I170A.056)	Australia w/ label
AS7740G-334G32Mn	EMEA	Spain	AS7740G-334G32Mn W7HP64ATES1 MC MADISON_PRO1GBCbK_V3 2*2G/320/8L2.4/5R/ CB_GN_0_3D_HG_ES51	Ci3330M	MADISON_PRO	1G-DDR3 (64*16*8)	SO2GBIII10	N320GB5.4KS	NSM8XS	5 in 1- Build in	3rd WiFi 2x2 BGN	N	8CELL2.4	90W	Spanish (KB.I170A.050)	Continental
AS7740G-436G64Mn	EMEA	Denmark	AS7740G-436G64Mn W7HP64ATDK2 MC MADISON_PRO1GBCbK_V3 4G+2G/640/8L2.2/5R/ CB_GN_0_3D_HG_ENS1	Ci5430M	MADISON_PRO	1G-DDR3 (64*16*8)	SO4GBIII10 / SO2GBIII10	N640GB5.4KS	NSM8XS	5 in 1- Build in	3rd WiFi 2x2 BGN	N	6CELL2.2	90W	Nordic (KB.I170A.045)	Danish/ Continental
AS7740G-626G64Mn	EMEA	Denmark	AS7740G-626G64Mn W7HP64ATDK2 MC MADISON_PRO1GBCbK_V3 4G+2G/640/8L2.4/5R/ CB_GN_0_3D_HG_ENS1	Ci7620M	MADISON_PRO	1G-DDR3 (64*16*8)	SO4GBIII10 / SO2GBIII10	N640GB5.4KS	NSM8XS	5 in 1- Build in	3rd WiFi 2x2 BGN	N	8CELL2.4	90W	Nordic (KB.I170A.045)	Danish/ Continental
AS7740G-626G50Mn	EMEA	Ukraine	AS7740G-626G50Mn W7HP64RUATUK1 MC MADISON_PRO1GBCbK_V3 4G+2G/500_L/8L2.4/5R/ CB_GN_0_3D_HG_RU61	Ci7620M	MADISON_PRO	1G-DDR3 (64*16*8)	SO4GBIII10 / SO2GBIII10	N500GB5.4KS	NSM8XS	5 in 1- Build in	3rd WiFi 2x2 BGN	N	8CELL2.4	90W	Russian (KB.I170A.048)	Continental
AS7740G-626G50Mn	EMEA	Middle East	AS7740G-626G50Mn EM W7HP64EMATME4 MC MADISON_PRO1GBCbK_V3 4G+2G/500_L/8L2.4/5R/ CB_GN_0_3D_HG_RU61	Ci7620M	MADISON_PRO	1G-DDR3 (64*16*8)	SO4GBIII10 / SO2GBIII10	N500GB5.4KS	NSM8XS	5 in 1- Build in	3rd WiFi 2x2 BGN	N	8CELL2.4	90W	Russian (KB.I170A.048)	Continental
AS7740G-626G50Mn	EMEA	Middle East	AS7740G-626G50Mn EM W7HP64EMATME2 MC MADISON_PRO1GBCbK_V3 4G+2G/500_L/8L2.4/5R/ CB_GN_0_3D_HG_ES61	Ci7620M	MADISON_PRO	1G-DDR3 (64*16*8)	SO4GBIII10 / SO2GBIII10	N500GB5.4KS	NSM8XS	5 in 1- Build in	3rd WiFi 2x2 BGN	N	8CELL2.4	90W	Arabic (KB.I170A.032)	UK and US- 110V
AS7740G-626G50Mn	EMEA	South Africa	AS7740G-626G50Mn EM W7HP64EMATZA2 MC MADISON_PRO1GBCbK_V3 4G+2G/500_L/8L2.4/5R/ CB_GN_0_3D_HG_ES61	Ci7620M	MADISON_PRO	1G-DDR3 (64*16*8)	SO4GBIII10 / SO2GBIII10	N500GB5.4KS	NSM8XS	5 in 1- Build in	3rd WiFi 2x2 BGN	N	8CELL2.4	90W	US International (KB.I170A.056)	AF
AS7740G-626G50Mn	EMEA	Turkey	AS7740G-626G50Mn EM W7HP64EMATTR1 MC MADISON_PRO1GBCbK_V3 4G+2G/500_L/8L2.4/5R/ CB_GN_0_3D_HG_TR31	Ci7620M	MADISON_PRO	1G-DDR3 (64*16*8)	SO4GBIII10 / SO2GBIII10	N500GB5.4KS	NSM8XS	5 in 1- Build in	3rd WiFi 2x2 BGN	N	8CELL2.4	90W	Turkish (KB.I170A.054)	Continental
AS7740G-626G50Mn	EMEA	Middle East	AS7740G-626G50Mn EM W7HP64EMATME2 MC MADISON_PRO1GBCbK_V3 4G+2G/500_L/8L2.4/5R/ CB_GN_0_3D_HG_AR21	Ci7620M	MADISON_PRO	1G-DDR3 (64*16*8)	SO4GBIII10 / SO2GBIII10	N500GB5.4KS	NSM8XS	5 in 1- Build in	3rd WiFi 2x2 BGN	N	8CELL2.4	90W	Arabic (KB.I170A.032)	UK and US- 110V
AS7740G-626G50Mn	EMEA	Middle East	AS7740G-626G50Mn EM W7HP64EMATME9 MC MADISON_PRO1GBCbK_V3 4G+2G/500_L/8L2.4/5R/ CB_GN_0_3D_HG_ES81	Ci7620M	MADISON_PRO	1G-DDR3 (64*16*8)	SO4GBIII10 / SO2GBIII10	N500GB5.4KS	NSM8XS	5 in 1- Build in	3rd WiFi 2x2 BGN	N	8CELL2.4	90W	FR/Arabic (KB.I170A.038)	Continental
AS7740G-626G50Mn	EMEA	Algeria	AS7740G-626G50Mn EM W7HP64EMATDZ1 MC MADISON_PRO1GBCbK_V3 4G+2G/500_L/8L2.4/5R/ CB_GN_0_3D_HG_ES81	Ci7620M	MADISON_PRO	1G-DDR3 (64*16*8)	SO4GBIII10 / SO2GBIII10	N500GB5.4KS	NSM8XS	5 in 1- Build in	3rd WiFi 2x2 BGN	N	8CELL2.4	90W	FR/Arabic (KB.I170A.038)	Continental
AS7740G-626G50Mn	EMEA	Middle East	AS7740G-626G50Mn EM W7HP64EMATME4 MC MADISON_PRO1GBCbK_V3 4G+2G/500_L/8L2.4/5R/ CB_GN_0_3D_HG_ES61	Ci7620M	MADISON_PRO	1G-DDR3 (64*16*8)	SO4GBIII10 / SO2GBIII10	N500GB5.4KS	NSM8XS	5 in 1- Build in	3rd WiFi 2x2 BGN	N	8CELL2.4	90W	Russian (KB.I170A.048)	Continental
AS7740G-626G50Mn	EMEA	South Africa	AS7740G-626G50Mn EM W7HP64EMATZA1 MC MADISON_PRO1GBCbK_V3 4G+2G/500_L/8L2.4/5R/ CB_GN_0_3D_HG_ES61	Ci7620M	MADISON_PRO	1G-DDR3 (64*16*8)	SO4GBIII10 / SO2GBIII10	N500GB5.4KS	NSM8XS	5 in 1- Build in	3rd WiFi 2x2 BGN	N	8CELL2.4	90W	French (KB.I170A.039)	Continental
AS7740G-626G50Mn	EMEA	Middle East	AS7740G-626G50Mn EM W7HP64EMATME2 MC MADISON_PRO1GBCbK_V3 4G+2G/500_L/8L2.4/5R/ CB_GN_0_3D_HG_AR11	Ci7620M	MADISON_PRO	1G-DDR3 (64*16*8)	SO4GBIII10 / SO2GBIII10	N500GB5.4KS	NSM8XS	5 in 1- Build in	3rd WiFi 2x2 BGN	N	8CELL2.4	90W	Arabic (KB.I170A.032)	UK and US- 110V
AS7740G-626G50Mn	EMEA	Middle East	AS7740G-626G50Mn EM W7HP64EMATME3 MC MADISON_PRO1GBCbK_V3 4G+2G/500_L/8L2.4/5R/ CB_GN_0_3D_HG_ES81	Ci7620M	MADISON_PRO	1G-DDR3 (64*16*8)	SO4GBIII10 / SO2GBIII10	N500GB5.4KS	NSM8XS	5 in 1- Build in	3rd WiFi 2x2 BGN	N	8CELL2.4	90W	French (KB.I170A.039)	Continental
AS7740G-626G50Mn	EMEA	Middle East	AS7740G-626G50Mn EM W7HP64EMATME6 MC MADISON_PRO1GBCbK_V3 4G+2G/500_L/8L2.4/5R/ CB_GN_0_3D_HG_ES61	Ci7620M	MADISON_PRO	1G-DDR3 (64*16*8)	SO4GBIII10 / SO2GBIII10	N500GB5.4KS	NSM8XS	5 in 1- Build in	3rd WiFi 2x2 BGN	N	8CELL2.4	90W	US International (KB.I170A.056)	UK
AS7740G-626G50Mn	EMEA	South Africa	AS7740G-626G50Mn EM W7HP64EMATZA4 MC MADISON_PRO1GBCbK_V3 4G+2G/500_L/8L2.4/5R/ CB_GN_0_3D_HG_ES61	Ci7620M	MADISON_PRO	1G-DDR3 (64*16*8)	SO4GBIII10 / SO2GBIII10	N500GB5.4KS	NSM8XS	5 in 1- Build in	3rd WiFi 2x2 BGN	N	8CELL2.4	90W	US International (KB.I170A.056)	UK
AS7740G-626G50Mn	EMEA	Germany	AS7740G-626G50Mn W7HP64ATDE1 MC MADISON_PRO1GBCbK_V3 4G+2G/500_L/8L2.4/5R/ CB_GN_0_3D_HG_DE11	Ci7620M	MADISON_PRO	1G-DDR3 (64*16*8)	SO4GBIII10 / SO2GBIII10	N500GB5.4KS	NSM8XS	5 in 1- Build in	3rd WiFi 2x2 BGN	N	8CELL2.4	90W	German (KB.I170A.040)	Continental
AS7740G-626G50Mn	EMEA	Poland	AS7740G-626G50Mn W7HP64ATPL1 MC MADISON_PRO1GBCbK_V3 4G+2G/500_L/8L2.4/5R/ CB_GN_0_3D_HG_PL11	Ci7620M	MADISON_PRO	1G-DDR3 (64*16*8)	SO4GBIII10 / SO2GBIII10	N500GB5.4KS	NSM8XS	5 in 1- Build in	3rd WiFi 2x2 BGN	N	8CELL2.4	90W	US International (KB.I170A.056)	Continental

AS7740G-626G50Mn	EMEA	Holland	AS7740G-626G50Mn W7HP64ATNL1 MC MADISON_PRO1GBcbk_V3 4G+2G/500_L/8L2.4/5R/ CB_GN_0_3D_HG_NL11	Ci7620M	MADISON_PRO	1G-DDR3 (64*16*8)	SO4GBIII10 / SO2GBIII10	N500GB5.4KS	NSM8XS	5 in 1- Build in	3rd WiFi 2x2 BGN	N	8CELL2.4	90W	US International (KB.I170A.056)	Continental
AS7740G-626G50Mn	EMEA	Belgium	AS7740G-626G50Mn W7HP64ATBE1 MC MADISON_PRO1GBcbk_V3 4G+2G/500_L/8L2.4/5R/ CB_GN_0_3D_HG_NL11	Ci7620M	MADISON_PRO	1G-DDR3 (64*16*8)	SO4GBIII10 / SO2GBIII10	N500GB5.4KS	NSM8XS	5 in 1- Build in	3rd WiFi 2x2 BGN	N	8CELL2.4	90W	Belgium (KB.I170A.033)	Continental
AS7740G-626G50Mn	EMEA	Switzerland	AS7740G-626G50Mn W7HP64ATCH1 MC MADISON_PRO1GBcbk_V3 4G+2G/500_L/8L2.4/5R/ CB_GN_0_3D_HG_IT41	Ci7620M	MADISON_PRO	1G-DDR3 (64*16*8)	SO4GBIII10 / SO2GBIII10	N500GB5.4KS	NSM8XS	5 in 1- Build in	3rd WiFi 2x2 BGN	N	8CELL2.4	90W	Swiss/G (KB.I170A.052)	Swiss
AS7740G-626G50Mn	EMEA	Luxembourg	AS7740G-626G50Mn W7HP64ATLU3 MC MADISON_PRO1GBcbk_V3 4G+2G/500_L/8L2.4/5R/ CB_GN_0_3D_HG_IT41	Ci7620M	MADISON_PRO	1G-DDR3 (64*16*8)	SO4GBIII10 / SO2GBIII10	N500GB5.4KS	NSM8XS	5 in 1- Build in	3rd WiFi 2x2 BGN	N	8CELL2.4	90W	Swiss/G (KB.I170A.052)	Continental
AS7740G-626G50Mn	EMEA	Latvia	AS7740G-626G50Mn W7HP64ATLV1 MC MADISON_PRO1GBcbk_V3 4G+2G/500_L/8L2.4/5R/ CB_GN_0_3D_HG_RU22	Ci7620M	MADISON_PRO	1G-DDR3 (64*16*8)	SO4GBIII10 / SO2GBIII10	N500GB5.4KS	NSM8XS	5 in 1- Build in	3rd WiFi 2x2 BGN	N	8CELL2.4	90W	Russian (KB.I170A.048)	Continental
AS7740G-626G50Mn	EMEA	Italy	AS7740G-626G50Mn W7HP64ATIT1 MC MADISON_PRO1GBcbk_V3 4G+2G/500_L/8L2.4/5R/ CB_GN_0_3D_HG_IT11	Ci7620M	MADISON_PRO	1G-DDR3 (64*16*8)	SO4GBIII10 / SO2GBIII10	N500GB5.4KS	NSM8XS	5 in 1- Build in	3rd WiFi 2x2 BGN	N	8CELL2.4	90W	Italian (KB.I170A.043)	Italian
AS7740G-626G50Mn	EMEA	Denmark	AS7740G-626G50Mn W7HP64ATDK2 MC MADISON_PRO1GBcbk_V3 4G+2G/500_L/8L2.4/5R/ CB_GN_0_3D_HG_ENS1	Ci7620M	MADISON_PRO	1G-DDR3 (64*16*8)	SO4GBIII10 / SO2GBIII10	N500GB5.4KS	NSM8XS	5 in 1- Build in	3rd WiFi 2x2 BGN	N	8CELL2.4	90W	Nordic (KB.I170A.045)	Danish/ Continental
AS7740G-626G50Mn	EMEA	Eastern Europe	AS7740G-626G50Mn W7HP64ATEU7 MC MADISON_PRO1GBcbk_V3 4G+2G/500_L/8L2.4/5R/ CB_GN_0_3D_HG_ENQ1	Ci7620M	MADISON_PRO	1G-DDR3 (64*16*8)	SO4GBIII10 / SO2GBIII10	N500GB5.4KS	NSM8XS	5 in 1- Build in	3rd WiFi 2x2 BGN	N	8CELL2.4	90W	SLO/CRO (KB.I170A.049)	Continental
AS7740G-626G50Mn	EMEA	Latvia	AS7740G-626G50Mn W7HP64ATLV1 MC MADISON_PRO1GBcbk_V3 4G+2G/500_L/8L2.4/5R/ CB_GN_0_3D_HG_LT11	Ci7620M	MADISON_PRO	1G-DDR3 (64*16*8)	SO4GBIII10 / SO2GBIII10	N500GB5.4KS	NSM8XS	5 in 1- Build in	3rd WiFi 2x2 BGN	N	8CELL2.4	90W	Russian (KB.I170A.048)	Continental
AS7740G-626G50Mn	EMEA	Eastern Europe	AS7740G-626G50Mn W7HP64ATEU5 MC MADISON_PRO1GBcbk_V3 4G+2G/500_L/8L2.4/5R/ CB_GN_0_3D_HG_PL71	Ci7620M	MADISON_PRO	1G-DDR3 (64*16*8)	SO4GBIII10 / SO2GBIII10	N500GB5.4KS	NSM8XS	5 in 1- Build in	3rd WiFi 2x2 BGN	N	8CELL2.4	90W	US International (KB.I170A.056)	Continental
AS7740G-626G50Mn	EMEA	Eastern Europe	AS7740G-626G50Mn W7HP64ATEU5 MC MADISON_PRO1GBcbk_V3 4G+2G/500_L/8L2.4/5R/ CB_GN_0_3D_HG_RO11	Ci7620M	MADISON_PRO	1G-DDR3 (64*16*8)	SO4GBIII10 / SO2GBIII10	N500GB5.4KS	NSM8XS	5 in 1- Build in	3rd WiFi 2x2 BGN	N	8CELL2.4	90W	US International (KB.I170A.056)	Continental
AS7740G-626G50Mn	EMEA	Czech	AS7740G-626G50Mn W7HP64ATCZ2 MC MADISON_PRO1GBcbk_V3 4G+2G/500_L/8L2.4/5R/ CB_GN_0_3D_HG_SK11	Ci7620M	MADISON_PRO	1G-DDR3 (64*16*8)	SO4GBIII10 / SO2GBIII10	N500GB5.4KS	NSM8XS	5 in 1- Build in	3rd WiFi 2x2 BGN	N	8CELL2.4	90W	CZ/SK (KB.I170A.035)	Continental
AS7740G-626G50Mn	EMEA	Hungary	AS7740G-626G50Mn W7HP64ATHU1 MC MADISON_PRO1GBcbk_V3 4G+2G/500_L/8L2.4/5R/ CB_GN_0_3D_HG_HU11	Ci7620M	MADISON_PRO	1G-DDR3 (64*16*8)	SO4GBIII10 / SO2GBIII10	N500GB5.4KS	NSM8XS	5 in 1- Build in	3rd WiFi 2x2 BGN	N	8CELL2.4	90W	Hungarian (KB.I170A.042)	Continental
AS7740G-626G50Mn	EMEA	Israel	AS7740G-626G50Mn W7HP64ATIL1 MC MADISON_PRO1GBcbk_V3 4G+2G/500_L/8L2.4/5R/ CB_GN_0_3D_HG_HE11	Ci7620M	MADISON_PRO	1G-DDR3 (64*16*8)	SO4GBIII10 / SO2GBIII10	N500GB5.4KS	NSM8XS	5 in 1- Build in	3rd WiFi 2x2 BGN	N	8CELL2.4	90W	US International w/ Hebrew (KB.I170A.057)	Israel
AS7740G-626G50Mn	EMEA	Portugal	AS7740G-626G50Mn W7HP64ATPT1 MC MADISON_PRO1GBcbk_V3 4G+2G/500_L/8L2.4/5R/ CB_GN_0_3D_HG_PT11	Ci7620M	MADISON_PRO	1G-DDR3 (64*16*8)	SO4GBIII10 / SO2GBIII10	N500GB5.4KS	NSM8XS	5 in 1- Build in	3rd WiFi 2x2 BGN	N	8CELL2.4	90W	Portuguese (KB.I170A.047)	Continental
AS7740G-626G50Mn	EMEA	Cyprus	AS7740G-626G50Mn W7HP64ATCY1 MC MADISON_PRO1GBcbk_V3 4G+2G/500_L/8L2.4/5R/ CB_GN_0_3D_HG_ES61	Ci7620M	MADISON_PRO	1G-DDR3 (64*16*8)	SO4GBIII10 / SO2GBIII10	N500GB5.4KS	NSM8XS	5 in 1- Build in	3rd WiFi 2x2 BGN	N	8CELL2.4	90W	UK (KB.I170A.055)	UK
AS7740G-626G50Mn	EMEA	Eastern Europe	AS7740G-626G50Mn W7HP64ATEU7 MC MADISON_PRO1GBcbk_V3 4G+2G/500_L/8L2.4/5R/ CB_GN_0_3D_HG_SL11	Ci7620M	MADISON_PRO	1G-DDR3 (64*16*8)	SO4GBIII10 / SO2GBIII10	N500GB5.4KS	NSM8XS	5 in 1- Build in	3rd WiFi 2x2 BGN	N	8CELL2.4	90W	SLO/CRO (KB.I170A.049)	Continental
AS7740G-334G50Mn	EMEA	Ukraine	AS7740G-334G50Mn W7HP64RUATUK1 MC MADISON_PRO1GBcbk_V3 2*2G/500_L/8L2.4/5R/ CB_GN_0_3D_HG_RU61	Ci3330M	MADISON_PRO	1G-DDR3 (64*16*8)	SO2GBIII10	N500GB5.4KS	NSM8XS	5 in 1- Build in	3rd WiFi 2x2 BGN	N	8CELL2.4	90W	Russian (KB.I170A.048)	Continental
AS7740G-334G50Mn	EMEA	Middle East	AS7740G-334G50Mn Em W7HP64EMATME4 MC MADISON_PRO1GBcbk_V3 2*2G/500_L/8L2.4/5R/ CB_GN_0_3D_HG_RU61	Ci3330M	MADISON_PRO	1G-DDR3 (64*16*8)	SO2GBIII10	N500GB5.4KS	NSM8XS	5 in 1- Build in	3rd WiFi 2x2 BGN	N	8CELL2.4	90W	Russian (KB.I170A.048)	Continental
AS7740G-334G50Mn	EMEA	Middle East	AS7740G-334G50Mn Em W7HP64EMATME2 MC MADISON_PRO1GBcbk_V3 2*2G/500_L/8L2.4/5R/ CB_GN_0_3D_HG_ES61	Ci3330M	MADISON_PRO	1G-DDR3 (64*16*8)	SO2GBIII10	N500GB5.4KS	NSM8XS	5 in 1- Build in	3rd WiFi 2x2 BGN	N	8CELL2.4	90W	Arabic (KB.I170A.032)	UK and US- 110V
AS7740G-334G50Mn	EMEA	South Africa	AS7740G-334G50Mn Em W7HP64EMATZA2 MC MADISON_PRO1GBcbk_V3 2*2G/500_L/8L2.4/5R/ CB_GN_0_3D_HG_ES61	Ci3330M	MADISON_PRO	1G-DDR3 (64*16*8)	SO2GBIII10	N500GB5.4KS	NSM8XS	5 in 1- Build in	3rd WiFi 2x2 BGN	N	8CELL2.4	90W	US International (KB.I170A.056)	AF

AS7740G-334G50Mn	EMEA	Turkey	AS7740G-334G50Mn EM W7HP64EMATTR1 MC MADISON_PRO1GBCbK_V3 2'2G/500_L/8L2.4/5R/ CB_GN_0.3D_HG_TR31	Ci3330M	MADISON_PRO	1G-DDR3 (64*16*8)	SO2GBIII10	N500GB5.4KS	NSM8XS	5 in 1- Build in	3rd WiFi 2x2 BGN	N	8CELL2.4	90W	Turkish (KB.I170A.054)	Continental
AS7740G-334G50Mn	EMEA	Middle East	AS7740G-334G50Mn EM W7HP64EMATME2 MC MADISON_PRO1GBCbK_V3 2'2G/500_L/8L2.4/5R/ CB_GN_0.3D_HG_AR21	Ci3330M	MADISON_PRO	1G-DDR3 (64*16*8)	SO2GBIII10	N500GB5.4KS	NSM8XS	5 in 1- Build in	3rd WiFi 2x2 BGN	N	8CELL2.4	90W	Arabic (KB.I170A.032)	UK and US-110V
AS7740G-334G50Mn	EMEA	Middle East	AS7740G-334G50Mn EM W7HP64EMATME9 MC MADISON_PRO1GBCbK_V3 2'2G/500_L/8L2.4/5R/ CB_GN_0.3D_HG_ES81	Ci3330M	MADISON_PRO	1G-DDR3 (64*16*8)	SO2GBIII10	N500GB5.4KS	NSM8XS	5 in 1- Build in	3rd WiFi 2x2 BGN	N	8CELL2.4	90W	FR/Arabic (KB.I170A.038)	Continental
AS7740G-626G50Mn	EMEA	Serbia/ Macedonia	AS7740G-626G50Mn W7HP64ATCS1 MC MADISON_PRO1GBCbK_V3 4G+2G/500_L/8L2.4/5R/ CB_GN_0.3D_HG_SL11	Ci7620M	MADISON_PRO	1G-DDR3 (64*16*8)	SO4GBIII10 / SO2GBIII10	N500GB5.4KS	NSM8XS	5 in 1- Build in	3rd WiFi 2x2 BGN	N	8CELL2.4	90W	SLO/CRO (KB.I170A.049)	Continental
AS7740G-626G50Mn	EMEA	Eastern Europe	AS7740G-626G50Mn W7HP64ATEU4 MC MADISON_PRO1GBCbK_V3 4G+2G/500_L/8L2.4/5R/ CB_GN_0.3D_HG_SV21	Ci7620M	MADISON_PRO	1G-DDR3 (64*16*8)	SO4GBIII10 / SO2GBIII10	N500GB5.4KS	NSM8XS	5 in 1- Build in	3rd WiFi 2x2 BGN	N	8CELL2.4	90W	Sweden (KB.I170A.051)	Continental
AS7740G-626G50Mn	EMEA	Greece	AS7740G-626G50Mn W7HP64ATGR1 MC MADISON_PRO1GBCbK_V3 4G+2G/500_L/8L2.4/5R/ CB_GN_0.3D_HG_EL31	Ci7620M	MADISON_PRO	1G-DDR3 (64*16*8)	SO4GBIII10 / SO2GBIII10	N500GB5.4KS	NSM8XS	5 in 1- Build in	3rd WiFi 2x2 BGN	N	8CELL2.4	90W	Greek (KB.I170A.041)	Continental
AS7740G-626G50Mn	EMEA	Austria	AS7740G-626G50Mn W7HP64ATAT1 MC MADISON_PRO1GBCbK_V3 4G+2G/500_L/8L2.4/5R/ CB_GN_0.3D_HG_DE61	Ci7620M	MADISON_PRO	1G-DDR3 (64*16*8)	SO4GBIII10 / SO2GBIII10	N500GB5.4KS	NSM8XS	5 in 1- Build in	3rd WiFi 2x2 BGN	N	8CELL2.4	90W	German (KB.I170A.040)	Continental
AS7740G-626G50Mn	EMEA	France	AS7740G-626G50Mn W7HP64ATFR1 MC MADISON_PRO1GBCbK_V3 4G+2G/500_L/8L2.4/5R/ CB_GN_0.3D_HG_FR21	Ci7620M	MADISON_PRO	1G-DDR3 (64*16*8)	SO4GBIII10 / SO2GBIII10	N500GB5.4KS	NSM8XS	5 in 1- Build in	3rd WiFi 2x2 BGN	N	8CELL2.4	90W	French (KB.I170A.039)	Continental
AS7740G-334G50Mn	EMEA	Middle East	AS7740G-334G50Mn EM W7HP64EMATME2 MC MADISON_PRO1GBCbK_V3 2'2G/500_L/8L2.4/5R/ CB_GN_0.3D_HG_AR11	Ci3330M	MADISON_PRO	1G-DDR3 (64*16*8)	SO2GBIII10	N500GB5.4KS	NSM8XS	5 in 1- Build in	3rd WiFi 2x2 BGN	N	8CELL2.4	90W	Arabic (KB.I170A.032)	UK and US-110V
AS7740G-334G50Mn	EMEA	Middle East	AS7740G-334G50Mn EM W7HP64EMATME3 MC MADISON_PRO1GBCbK_V3 2'2G/500_L/8L2.4/5R/ CB_GN_0.3D_HG_ES81	Ci3330M	MADISON_PRO	1G-DDR3 (64*16*8)	SO2GBIII10	N500GB5.4KS	NSM8XS	5 in 1- Build in	3rd WiFi 2x2 BGN	N	8CELL2.4	90W	French (KB.I170A.039)	Continental
AS7740G-334G50Mn	EMEA	Middle East	AS7740G-334G50Mn EM W7HP64EMATME6 MC MADISON_PRO1GBCbK_V3 2'2G/500_L/8L2.4/5R/ CB_GN_0.3D_HG_ES61	Ci3330M	MADISON_PRO	1G-DDR3 (64*16*8)	SO2GBIII10	N500GB5.4KS	NSM8XS	5 in 1- Build in	3rd WiFi 2x2 BGN	N	8CELL2.4	90W	US International (KB.I170A.056)	UK
AS7740G-334G50Mn	EMEA	South Africa	AS7740G-334G50Mn EM W7HP64EMATZA4 MC MADISON_PRO1GBCbK_V3 2'2G/500_L/8L2.4/5R/ CB_GN_0.3D_HG_ES61	Ci3330M	MADISON_PRO	1G-DDR3 (64*16*8)	SO2GBIII10	N500GB5.4KS	NSM8XS	5 in 1- Build in	3rd WiFi 2x2 BGN	N	8CELL2.4	90W	US International (KB.I170A.056)	UK
AS7740G-334G50Mn	EMEA	Germany	AS7740G-334G50Mn W7HP64ATDE1 MC MADISON_PRO1GBCbK_V3 2'2G/500_L/8L2.4/5R/ CB_GN_0.3D_HG_DE11	Ci3330M	MADISON_PRO	1G-DDR3 (64*16*8)	SO2GBIII10	N500GB5.4KS	NSM8XS	5 in 1- Build in	3rd WiFi 2x2 BGN	N	8CELL2.4	90W	German (KB.I170A.040)	Continental
AS7740G-334G50Mn	EMEA	Poland	AS7740G-334G50Mn W7HP64ATPL1 MC MADISON_PRO1GBCbK_V3 2'2G/500_L/8L2.4/5R/ CB_GN_0.3D_HG_PL11	Ci3330M	MADISON_PRO	1G-DDR3 (64*16*8)	SO2GBIII10	N500GB5.4KS	NSM8XS	5 in 1- Build in	3rd WiFi 2x2 BGN	N	8CELL2.4	90W	US International (KB.I170A.056)	Continental
AS7740G-334G50Mn	EMEA	Holland	AS7740G-334G50Mn W7HP64ATNL1 MC MADISON_PRO1GBCbK_V3 2'2G/500_L/8L2.4/5R/ CB_GN_0.3D_HG_NL11	Ci3330M	MADISON_PRO	1G-DDR3 (64*16*8)	SO2GBIII10	N500GB5.4KS	NSM8XS	5 in 1- Build in	3rd WiFi 2x2 BGN	N	8CELL2.4	90W	US International (KB.I170A.056)	Continental
AS7740G-334G50Mn	EMEA	Belgium	AS7740G-334G50Mn W7HP64ATBE1 MC MADISON_PRO1GBCbK_V3 2'2G/500_L/8L2.4/5R/ CB_GN_0.3D_HG_NL11	Ci3330M	MADISON_PRO	1G-DDR3 (64*16*8)	SO2GBIII10	N500GB5.4KS	NSM8XS	5 in 1- Build in	3rd WiFi 2x2 BGN	N	8CELL2.4	90W	Belgium (KB.I170A.033)	Continental
AS7740G-334G50Mn	EMEA	Switzerland	AS7740G-334G50Mn W7HP64ATCH1 MC MADISON_PRO1GBCbK_V3 2'2G/500_L/8L2.4/5R/ CB_GN_0.3D_HG_IT41	Ci3330M	MADISON_PRO	1G-DDR3 (64*16*8)	SO2GBIII10	N500GB5.4KS	NSM8XS	5 in 1- Build in	3rd WiFi 2x2 BGN	N	8CELL2.4	90W	Swiss/G (KB.I170A.052)	Swiss
AS7740G-334G50Mn	EMEA	Luxembourg	AS7740G-334G50Mn W7HP64ATLU3 MC MADISON_PRO1GBCbK_V3 2'2G/500_L/8L2.4/5R/ CB_GN_0.3D_HG_IT41	Ci3330M	MADISON_PRO	1G-DDR3 (64*16*8)	SO2GBIII10	N500GB5.4KS	NSM8XS	5 in 1- Build in	3rd WiFi 2x2 BGN	N	8CELL2.4	90W	Swiss/G (KB.I170A.052)	Continental
AS7740G-334G50Mn	EMEA	Latvia	AS7740G-334G50Mn W7HP64ATLV1 MC MADISON_PRO1GBCbK_V3 2'2G/500_L/8L2.4/5R/ CB_GN_0.3D_HG_RU22	Ci3330M	MADISON_PRO	1G-DDR3 (64*16*8)	SO2GBIII10	N500GB5.4KS	NSM8XS	5 in 1- Build in	3rd WiFi 2x2 BGN	N	8CELL2.4	90W	Russian (KB.I170A.048)	Continental
AS7740G-334G50Mn	EMEA	South Africa	AS7740G-334G50Mn EM W7HP64EMATZA1 MC MADISON_PRO1GBCbK_V3 2'2G/500_L/8L2.4/5R/ CB_GN_0.3D_HG_ES81	Ci3330M	MADISON_PRO	1G-DDR3 (64*16*8)	SO2GBIII10	N500GB5.4KS	NSM8XS	5 in 1- Build in	3rd WiFi 2x2 BGN	N	8CELL2.4	90W	French (KB.I170A.039)	Continental
AS7740G-334G50Mn	EMEA	Algeria	AS7740G-334G50Mn EM W7HP64EMATDZ1 MC MADISON_PRO1GBCbK_V3 2'2G/500_L/8L2.4/5R/ CB_GN_0.3D_HG_ES81	Ci3330M	MADISON_PRO	1G-DDR3 (64*16*8)	SO2GBIII10	N500GB5.4KS	NSM8XS	5 in 1- Build in	3rd WiFi 2x2 BGN	N	8CELL2.4	90W	FR/Arabic (KB.I170A.038)	Continental

AS7740G-334G50Mn	EMEA	Middle East	AS7740G-334G50Mn Em W7HP64EMATME4 MC MADISON_PRO1GBCbK_V3 2*2G/500_L/8L2.4/5R/ CB_GN_0_3D_HG_ES61	Ci3330M	MADISON_PRO	1G-DDR3 (64*16*8)	SO2GBIII10	N500GB5.4KS	NSM8XS	5 in 1- Build in	3rd WiFi 2x2 BGN	N	8CELL2.4	90W	Russian (KB.1170A.048)	Continental
AS7740G-334G50Mn	EMEA	Latvia	AS7740G-334G50Mn W7HP64ATLV1 MC MADISON_PRO1GBCbK_V3 2*2G/500_L/8L2.4/5R/ CB_GN_0_3D_HG_LT11	Ci3330M	MADISON_PRO	1G-DDR3 (64*16*8)	SO2GBIII10	N500GB5.4KS	NSM8XS	5 in 1- Build in	3rd WiFi 2x2 BGN	N	8CELL2.4	90W	Russian (KB.1170A.048)	Continental
AS7740G-334G50Mn	EMEA	UK	AS7740G-334G50Mn W7HP64ATGB1 MC MADISON_PRO1GBCbK_V3 2*2G/500_L/8L2.4/5R/ CB_GN_0_3D_HG_EN11	Ci3330M	MADISON_PRO	1G-DDR3 (64*16*8)	SO2GBIII10	N500GB5.4KS	NSM8XS	5 in 1- Build in	3rd WiFi 2x2 BGN	N	8CELL2.4	90W	UK (KB.1170A.055)	UK
AS7740G-334G50Mn	EMEA	Eastern Europe	AS7740G-334G50Mn W7HP64ATEU5 MC MADISON_PRO1GBCbK_V3 2*2G/500_L/8L2.4/5R/ CB_GN_0_3D_HG_RO11	Ci3330M	MADISON_PRO	1G-DDR3 (64*16*8)	SO2GBIII10	N500GB5.4KS	NSM8XS	5 in 1- Build in	3rd WiFi 2x2 BGN	N	8CELL2.4	90W	US International (KB.1170A.056)	Continental
AS7740G-334G50Mn	EMEA	Eastern Europe	AS7740G-334G50Mn W7HP64ATEU5 MC MADISON_PRO1GBCbK_V3 2*2G/500_L/8L2.4/5R/ CB_GN_0_3D_HG_PL71	Ci3330M	MADISON_PRO	1G-DDR3 (64*16*8)	SO2GBIII10	N500GB5.4KS	NSM8XS	5 in 1- Build in	3rd WiFi 2x2 BGN	N	8CELL2.4	90W	US International (KB.1170A.056)	Continental
AS7740G-334G50Mn	EMEA	Czech	AS7740G-334G50Mn W7HP64ATCZ2 MC MADISON_PRO1GBCbK_V3 2*2G/500_L/8L2.4/5R/ CB_GN_0_3D_HG_SK11	Ci3330M	MADISON_PRO	1G-DDR3 (64*16*8)	SO2GBIII10	N500GB5.4KS	NSM8XS	5 in 1- Build in	3rd WiFi 2x2 BGN	N	8CELL2.4	90W	CZ/SK (KB.1170A.035)	Continental
AS7740G-334G50Mn	EMEA	Hungary	AS7740G-334G50Mn W7HP64ATHU1 MC MADISON_PRO1GBCbK_V3 2*2G/500_L/8L2.4/5R/ CB_GN_0_3D_HG_HU11	Ci3330M	MADISON_PRO	1G-DDR3 (64*16*8)	SO2GBIII10	N500GB5.4KS	NSM8XS	5 in 1- Build in	3rd WiFi 2x2 BGN	N	8CELL2.4	90W	Hungarian (KB.1170A.042)	Continental
AS7740G-334G50Mn	EMEA	Israel	AS7740G-334G50Mn W7HP64ATIL1 MC MADISON_PRO1GBCbK_V3 2*2G/500_L/8L2.4/5R/ CB_GN_0_3D_HG_HE11	Ci3330M	MADISON_PRO	1G-DDR3 (64*16*8)	SO2GBIII10	N500GB5.4KS	NSM8XS	5 in 1- Build in	3rd WiFi 2x2 BGN	N	8CELL2.4	90W	US International w/ Hebrew (KB.1170A.057)	Israel
AS7740G-334G50Mn	EMEA	Portugal	AS7740G-334G50Mn W7HP64ATPT1 MC MADISON_PRO1GBCbK_V3 2*2G/500_L/8L2.4/5R/ CB_GN_0_3D_HG_PT11	Ci3330M	MADISON_PRO	1G-DDR3 (64*16*8)	SO2GBIII10	N500GB5.4KS	NSM8XS	5 in 1- Build in	3rd WiFi 2x2 BGN	N	8CELL2.4	90W	Portuguese (KB.1170A.047)	Continental
AS7740G-334G50Mn	EMEA	Cyprus	AS7740G-334G50Mn W7HP64ATCY1 MC MADISON_PRO1GBCbK_V3 2*2G/500_L/8L2.4/5R/ CB_GN_0_3D_HG_ES61	Ci3330M	MADISON_PRO	1G-DDR3 (64*16*8)	SO2GBIII10	N500GB5.4KS	NSM8XS	5 in 1- Build in	3rd WiFi 2x2 BGN	N	8CELL2.4	90W	UK (KB.1170A.055)	UK
AS7740G-334G50Mn	EMEA	Italy	AS7740G-334G50Mn W7HP64ATIT1 MC MADISON_PRO1GBCbK_V3 2*2G/500_L/8L2.4/5R/ CB_GN_0_3D_HG_IT11	Ci3330M	MADISON_PRO	1G-DDR3 (64*16*8)	SO2GBIII10	N500GB5.4KS	NSM8XS	5 in 1- Build in	3rd WiFi 2x2 BGN	N	8CELL2.4	90W	Italian (KB.1170A.043)	Italian
AS7740G-334G50Mn	EMEA	Spain	AS7740G-334G50Mn W7HP64ATES1 MC MADISON_PRO1GBCbK_V3 2*2G/500_L/8L2.4/5R/ CB_GN_0_3D_HG_ES51	Ci3330M	MADISON_PRO	1G-DDR3 (64*16*8)	SO2GBIII10	N500GB5.4KS	NSM8XS	5 in 1- Build in	3rd WiFi 2x2 BGN	N	8CELL2.4	90W	Spanish (KB.1170A.050)	Continental
AS7740G-334G50Mn	EMEA	Denmark	AS7740G-334G50Mn W7HP64ATDK2 MC MADISON_PRO1GBCbK_V3 2*2G/500_L/8L2.4/5R/ CB_GN_0_3D_HG_ENS1	Ci3330M	MADISON_PRO	1G-DDR3 (64*16*8)	SO2GBIII10	N500GB5.4KS	NSM8XS	5 in 1- Build in	3rd WiFi 2x2 BGN	N	8CELL2.4	90W	Nordic (KB.1170A.045)	Danish/ Continental
AS7740G-334G50Mn	EMEA	Eastern Europe	AS7740G-334G50Mn W7HP64ATEU7 MC MADISON_PRO1GBCbK_V3 2*2G/500_L/8L2.4/5R/ CB_GN_0_3D_HG_ENQ1	Ci3330M	MADISON_PRO	1G-DDR3 (64*16*8)	SO2GBIII10	N500GB5.4KS	NSM8XS	5 in 1- Build in	3rd WiFi 2x2 BGN	N	8CELL2.4	90W	SLO/CRO (KB.1170A.049)	Continental
AS7740G-334G50Mn	EMEA	Serbia/ Macedonia	AS7740G-334G50Mn W7HP64ATCS1 MC MADISON_PRO1GBCbK_V3 2*2G/500_L/8L2.4/5R/ CB_GN_0_3D_HG_SL11	Ci3330M	MADISON_PRO	1G-DDR3 (64*16*8)	SO2GBIII10	N500GB5.4KS	NSM8XS	5 in 1- Build in	3rd WiFi 2x2 BGN	N	8CELL2.4	90W	SLO/CRO (KB.1170A.049)	Continental
AS7740G-334G50Mn	EMEA	Eastern Europe	AS7740G-334G50Mn W7HP64ATEU4 MC MADISON_PRO1GBCbK_V3 2*2G/500_L/8L2.4/5R/ CB_GN_0_3D_HG_SV21	Ci3330M	MADISON_PRO	1G-DDR3 (64*16*8)	SO2GBIII10	N500GB5.4KS	NSM8XS	5 in 1- Build in	3rd WiFi 2x2 BGN	N	8CELL2.4	90W	Sweden (KB.1170A.051)	Continental
AS7740G-334G50Mn	EMEA	Greece	AS7740G-334G50Mn W7HP64ATGR1 MC MADISON_PRO1GBCbK_V3 2*2G/500_L/8L2.4/5R/ CB_GN_0_3D_HG_EL31	Ci3330M	MADISON_PRO	1G-DDR3 (64*16*8)	SO2GBIII10	N500GB5.4KS	NSM8XS	5 in 1- Build in	3rd WiFi 2x2 BGN	N	8CELL2.4	90W	Greek (KB.1170A.041)	Continental
AS7740G-334G50Mn	EMEA	Austria	AS7740G-334G50Mn W7HP64ATAT1 MC MADISON_PRO1GBCbK_V3 2*2G/500_L/8L2.4/5R/ CB_GN_0_3D_HG_DE61	Ci3330M	MADISON_PRO	1G-DDR3 (64*16*8)	SO2GBIII10	N500GB5.4KS	NSM8XS	5 in 1- Build in	3rd WiFi 2x2 BGN	N	8CELL2.4	90W	German (KB.1170A.040)	Continental
AS7740G-334G50Mn	EMEA	France	AS7740G-334G50Mn W7HP64ATFR1 MC MADISON_PRO1GBCbK_V3 2*2G/500_L/8L2.4/5R/ CB_GN_0_3D_HG_FR21	Ci3330M	MADISON_PRO	1G-DDR3 (64*16*8)	SO2GBIII10	N500GB5.4KS	NSM8XS	5 in 1- Build in	3rd WiFi 2x2 BGN	N	8CELL2.4	90W	French (KB.1170A.039)	Continental
AS7740G-334G50Mn	EMEA	Eastern Europe	AS7740G-334G50Mn W7HP64ATEU7 MC MADISON_PRO1GBCbK_V3 2*2G/500_L/8L2.4/5R/ CB_GN_0_3D_HG_SL11	Ci3330M	MADISON_PRO	1G-DDR3 (64*16*8)	SO2GBIII10	N500GB5.4KS	NSM8XS	5 in 1- Build in	3rd WiFi 2x2 BGN	N	8CELL2.4	90W	SLO/CRO (KB.1170A.049)	Continental
AS7740G-438G64Mn	EMEA	Spain	AS7740G-438G64Mn W7HP64ATES1 MC MADISON_PRO1GBCbK_V3 2*4G/640/8L2.4/5R/ CB_GN_0_3D_HG_ES51	Ci5430M	MADISON_PRO	1G-DDR3 (64*16*8)	SO4GBIII10	N640GB5.4KS	NSM8XS	5 in 1- Build in	3rd WiFi 2x2 BGN	N	8CELL2.4	90W	Spanish (KB.1170A.050)	Continental

AS7740G-438G64Bn	EMEA	South Africa	AS7740G-438G64Bn EM W7HP64EMATZA2 MC MADISON_PRO1GBCbk_V3 2G+4G/640/6L2.2/5R/ CB_GN_0.3D_HG_ES61	Ci5430M	MADISON_PRO	1G-DDR3 (64*16*8)	SO2GBIII10 / SO4GBIII10	N640GB5.4KS	NBDCB4XS	5 in 1- Build in	3rd WiFi 2x2 BGN	BT 2.1	6CELL2.2	90W	US International (KB.I170A.056)	AF
AS7740G-334G64Mn	EMEA	Denmark	AS7740G-334G64Mn W7HP64ATDK2 MC MADISON_PRO1GBCbk_V3 2*2G/640/6L2.2/5R/ CB_GN_0.3D_HG_ENS1	Ci3330M	MADISON_PRO	1G-DDR3 (64*16*8)	SO2GBIII10	N640GB5.4KS	NSM8XS	5 in 1- Build in	3rd WiFi 2x2 BGN	N	6CELL2.2	90W	Nordic (KB.I170A.045)	Danish/ Continental
AS7740G-334G64Bn	EMEA	Switzerland	AS7740G-334G64Bn W7HP64ATCH1 MC MADISON_PRO1GBCbk_V3 2*2G/640/6L2.2/5R/ CB_GN_0.3D_HG_IT41	Ci3330M	MADISON_PRO	1G-DDR3 (64*16*8)	SO2GBIII10	N640GB5.4KS	NBDCB4XS	5 in 1- Build in	3rd WiFi 2x2 BGN	N	6CELL2.2	90W	Swiss/G (KB.I170A.052)	Swiss
AS7740G-334G32Mn	EMEA	Switzerland	AS7740G-334G32Mn W7HP64ATCH1 MC MADISON_PRO1GBCbk_V3 2*2G/320/6L2.2/5R/ CB_GN_0.3D_HG_IT41	Ci3330M	MADISON_PRO	1G-DDR3 (64*16*8)	SO2GBIII10	N320GB5.4KS	NSM8XS	5 in 1- Build in	3rd WiFi 2x2 BGN	N	6CELL2.2	90W	Swiss/G (KB.I170A.052)	Swiss
AS7740G-438G64Mn	EMEA	Eastern Europe	AS7740G-438G64Mn LIMPUSAEU7 MADISON_PRO1GBCbk_V3 4G+2G/640/6L2.4/5R/ CB_GN_0.3D_HG_ENQ1	Ci5430M	MADISON_PRO	1G-DDR3 (64*16*8)	SO2GBIII10 / SO4GBIII10	N640GB5.4KS	NSM8XS	5 in 1- Build in	3rd WiFi 2x2 BGN	BT 2.1	8CELL2.4	90W	SLO/CRO (KB.I170A.049)	Continental
AS7740G-334G50Mn	EMEA	Eastern Europe	AS7740G-334G50Mn LIMPUSAEU7 MADISON_PRO1GBCbk_V3 2*2G/500_LBT/8L2.4/5R/ CB_GN_0.3D_HG_ENQ1	Ci3330M	MADISON_PRO	1G-DDR3 (64*16*8)	SO2GBIII10	N500GB5.4KS	NSM8XS	5 in 1- Build in	3rd WiFi 2x2 BGN	BT 2.1	8CELL2.4	90W	SLO/CRO (KB.I170A.049)	Continental
AS7740G-628G64Mn	EMEA	Czech	AS7740G-628G64Mn W7HP64ATCZ2 MC MADISON_PRO1GBCbk_V3 2*4G/640/6L2.4/5R/ CB_GN_0.3D_HG_SK11	Ci7620M	MADISON_PRO	1G-DDR3 (64*16*8)	SO4GBIII10	N640GB5.4KS	NSM8XS	5 in 1- Build in	3rd WiFi 2x2 BGN	BT 2.1	8CELL2.4	90W	CZ/SK (KB.I170A.035)	Continental
AS7740G-438G64Mn	EMEA	Algeria	AS7740G-438G64Mn EM W7HP64EMATDZ1 MC MADISON_PRO1GBCbk_V3 2*4G/640/6L2.2/5R/ CB_GN_0.3D_HG_ES81	Ci5430M	MADISON_PRO	1G-DDR3 (64*16*8)	SO4GBIII10	N640GB5.4KS	NSM8XS	5 in 1- Build in	3rd WiFi 2x2 BGN	N	6CELL2.2	90W	FR/Arabic (KB.I170A.038)	Continental
AS7740G-434G64Mn	EMEA	Latvia	AS7740G-434G64Mn W7HP64ATLV1 MC MADISON_PRO1GBCbk_V3 2*2G/640/6L2.2/5R/ CB_GN_0.3D_HG_RU22	Ci5430M	MADISON_PRO	1G-DDR3 (64*16*8)	SO2GBIII10	N640GB5.4KS	NSM8XS	5 in 1- Build in	3rd WiFi 2x2 BGN	N	6CELL2.2	90W	Russian (KB.I170A.048)	Continental
AS7740G-438G64Mn	EMEA	Latvia	AS7740G-438G64Mn W7HP64ATLV1 MC MADISON_PRO1GBCbk_V3 2*4G/640/6L2.2/5R/ CB_GN_0.3D_HG_RU22	Ci5430M	MADISON_PRO	1G-DDR3 (64*16*8)	SO4GBIII10	N640GB5.4KS	NSM8XS	5 in 1- Build in	3rd WiFi 2x2 BGN	N	6CELL2.2	90W	Russian (KB.I170A.048)	Continental
AS7740G-434G64Mn	EMEA	Ukraine	AS7740G-434G64Mn W7HP64RUATUK1 MC MADISON_PRO1GBCbk_V3 2*2G/640/6L2.2/5R/ CB_GN_0.3D_HG_RU61	Ci5430M	MADISON_PRO	1G-DDR3 (64*16*8)	SO2GBIII10	N640GB5.4KS	NSM8XS	5 in 1- Build in	3rd WiFi 2x2 BGN	N	6CELL2.2	90W	Russian (KB.I170A.048)	Continental
AS7740G-438G64Mn	EMEA	Ukraine	AS7740G-438G64Mn W7HP64RUATUK1 MC MADISON_PRO1GBCbk_V3 2*4G/640/6L2.2/5R/ CB_GN_0.3D_HG_RU61	Ci5430M	MADISON_PRO	1G-DDR3 (64*16*8)	SO4GBIII10	N640GB5.4KS	NSM8XS	5 in 1- Build in	3rd WiFi 2x2 BGN	N	6CELL2.2	90W	Russian (KB.I170A.048)	Continental
AS7740G-434G64Mn	EMEA	Middle East	AS7740G-434G64Mn EM W7HP64EMATME4 MC MADISON_PRO1GBCbk_V3 2*2G/640/6L2.2/5R/ CB_GN_0.3D_HG_RU61	Ci5430M	MADISON_PRO	1G-DDR3 (64*16*8)	SO2GBIII10	N640GB5.4KS	NSM8XS	5 in 1- Build in	3rd WiFi 2x2 BGN	N	6CELL2.2	90W	Russian (KB.I170A.048)	Continental
AS7740G-434G64Mn	EMEA	Middle East	AS7740G-434G64Mn EM W7HP64EMATME4 MC MADISON_PRO1GBCbk_V3 2*2G/640/6L2.2/5R/ CB_GN_0.3D_HG_ES61	Ci5430M	MADISON_PRO	1G-DDR3 (64*16*8)	SO2GBIII10	N640GB5.4KS	NSM8XS	5 in 1- Build in	3rd WiFi 2x2 BGN	N	6CELL2.2	90W	Russian (KB.I170A.048)	Continental
AS7740G-438G64Mn	EMEA	Middle East	AS7740G-438G64Mn EM W7HP64EMATME4 MC MADISON_PRO1GBCbk_V3 2*4G/640/6L2.2/5R/ CB_GN_0.3D_HG_RU61	Ci5430M	MADISON_PRO	1G-DDR3 (64*16*8)	SO4GBIII10	N640GB5.4KS	NSM8XS	5 in 1- Build in	3rd WiFi 2x2 BGN	N	6CELL2.2	90W	Russian (KB.I170A.048)	Continental
AS7740G-438G64Mn	EMEA	Middle East	AS7740G-438G64Mn EM W7HP64EMATME4 MC MADISON_PRO1GBCbk_V3 2*4G/640/6L2.2/5R/ CB_GN_0.3D_HG_ES61	Ci5430M	MADISON_PRO	1G-DDR3 (64*16*8)	SO4GBIII10	N640GB5.4KS	NSM8XS	5 in 1- Build in	3rd WiFi 2x2 BGN	N	6CELL2.2	90W	Russian (KB.I170A.048)	Continental
AS7740G-334G32Mn	EMEA	Turkey	AS7740G-334G32Mn EM W7HP64EMATTR1 MC MADISON_PRO1GBCbk_V3 2*2G/320/6L2.2/5R/ CB_GN_0.3D_HG_TR31	Ci3330M	MADISON_PRO	1G-DDR3 (64*16*8)	SO2GBIII10	N320GB5.4KS	NSM8XS	5 in 1- Build in	3rd WiFi 2x2 BGN	BT 2.1	6CELL2.2	90W	Turkish (KB.I170A.054)	Continental
AS7740G-434G64Mn	EMEA	Turkey	AS7740G-434G64Mn EM W7HP64EMATTR1 MC MADISON_PRO1GBCbk_V3 2*2G/640/6L2.2/5R/ CB_GN_0.3D_HG_TR31	Ci5430M	MADISON_PRO	1G-DDR3 (64*16*8)	SO2GBIII10	N640GB5.4KS	NSM8XS	5 in 1- Build in	3rd WiFi 2x2 BGN	N	6CELL2.2	90W	Turkish (KB.I170A.054)	Continental
AS7740G-438G64Mn	EMEA	Turkey	AS7740G-438G64Mn EM W7HP64EMATTR1 MC MADISON_PRO1GBCbk_V3 2*4G/640/6L2.2/5R/ CB_GN_0.3D_HG_TR31	Ci5430M	MADISON_PRO	1G-DDR3 (64*16*8)	SO4GBIII10	N640GB5.4KS	NSM8XS	5 in 1- Build in	3rd WiFi 2x2 BGN	N	6CELL2.2	90W	Turkish (KB.I170A.054)	Continental
AS7740G-434G64Mn	EMEA	Belgium	AS7740G-434G64Mn W7HP64ATBE1 MC MADISON_PRO1GBCbk_V3 2*2G/640/6L2.2/5R/ CB_GN_0.3D_HG_NL11	Ci5430M	MADISON_PRO	1G-DDR3 (64*16*8)	SO2GBIII10	N640GB5.4KS	NSM8XS	5 in 1- Build in	3rd WiFi 2x2 BGN	N	6CELL2.2	90W	Belgium (KB.I170A.033)	Continental
AS7740G-438G64Mn	EMEA	Belgium	AS7740G-438G64Mn W7HP64ATBE1 MC MADISON_PRO1GBCbk_V3 2*4G/640/6L2.2/5R/ CB_GN_0.3D_HG_NL11	Ci5430M	MADISON_PRO	1G-DDR3 (64*16*8)	SO4GBIII10	N640GB5.4KS	NSM8XS	5 in 1- Build in	3rd WiFi 2x2 BGN	N	6CELL2.2	90W	Belgium (KB.I170A.033)	Continental

AS7740G-434G64Mn	EMEA	Middle East	AS7740G-434G64Mn EM W7HP64EMATME2 MC MADISON_PRO1GBCbk_V3 2*2G/640/6L2.2/5R/ CB_GN_0.3D_HG_ES61	Ci5430M	MADISON_PRO	1G-DDR3 (64*16*8)	SO2GBIII10	N640GB5.4KS	NSM8XS	5 in 1- Build in	3rd WiFi 2x2 BGN	N	6CELL2.2	90W	Arabic (KB.I170A.032)	UK and US- 110V
AS7740G-434G64Mn	EMEA	Middle East	AS7740G-434G64Mn EM W7HP64EMATME2 MC MADISON_PRO1GBCbk_V3 2*2G/640/6L2.2/5R/ CB_GN_0.3D_HG_AR21	Ci5430M	MADISON_PRO	1G-DDR3 (64*16*8)	SO2GBIII10	N640GB5.4KS	NSM8XS	5 in 1- Build in	3rd WiFi 2x2 BGN	N	6CELL2.2	90W	Arabic (KB.I170A.032)	UK and US- 110V
AS7740G-434G64Mn	EMEA	Middle East	AS7740G-434G64Mn EM W7HP64EMATME2 MC MADISON_PRO1GBCbk_V3 2*2G/640/6L2.2/5R/ CB_GN_0.3D_HG_AR11	Ci5430M	MADISON_PRO	1G-DDR3 (64*16*8)	SO2GBIII10	N640GB5.4KS	NSM8XS	5 in 1- Build in	3rd WiFi 2x2 BGN	N	6CELL2.2	90W	Arabic (KB.I170A.032)	UK and US- 110V
AS7740G-438G64Mn	EMEA	Middle East	AS7740G-438G64Mn EM W7HP64EMATME2 MC MADISON_PRO1GBCbk_V3 2*4G/640/6L2.2/5R/ CB_GN_0.3D_HG_ES61	Ci5430M	MADISON_PRO	1G-DDR3 (64*16*8)	SO4GBIII10	N640GB5.4KS	NSM8XS	5 in 1- Build in	3rd WiFi 2x2 BGN	N	6CELL2.2	90W	Arabic (KB.I170A.032)	UK and US- 110V
AS7740G-438G64Mn	EMEA	Middle East	AS7740G-438G64Mn EM W7HP64EMATME2 MC MADISON_PRO1GBCbk_V3 2*4G/640/6L2.2/5R/ CB_GN_0.3D_HG_AR21	Ci5430M	MADISON_PRO	1G-DDR3 (64*16*8)	SO4GBIII10	N640GB5.4KS	NSM8XS	5 in 1- Build in	3rd WiFi 2x2 BGN	N	6CELL2.2	90W	Arabic (KB.I170A.032)	UK and US- 110V
AS7740G-438G64Mn	EMEA	Middle East	AS7740G-438G64Mn EM W7HP64EMATME2 MC MADISON_PRO1GBCbk_V3 2*4G/640/6L2.2/5R/ CB_GN_0.3D_HG_AR11	Ci5430M	MADISON_PRO	1G-DDR3 (64*16*8)	SO4GBIII10	N640GB5.4KS	NSM8XS	5 in 1- Build in	3rd WiFi 2x2 BGN	N	6CELL2.2	90W	Arabic (KB.I170A.032)	UK and US- 110V
AS7740G-434G50Mn	EMEA	Italy	AS7740G-434G50Mn W7HP64ATTI1 MC MADISON_PRO1GBCbk_V3 2*2G/500_L/8L2.4/5R/ CB_GN_0.3D_HG_IT11	Ci5430M	MADISON_PRO	1G-DDR3 (64*16*8)	SO2GBIII10	N500GB5.4KS	NSM8XS	5 in 1- Build in	3rd WiFi 2x2 BGN	N	8CELL2.4	90W	Italian (KB.I170A.043)	Italian
AS7740G-624G50Mn	EMEA	Italy	AS7740G-624G50Mn W7HP64ATTI1 MC MADISON_PRO1GBCbk_V3 2*2G/500_L/8L2.4/5R/ CB_GN_0.3D_HG_IT11	Ci7620M	MADISON_PRO	1G-DDR3 (64*16*8)	SO2GBIII10	N500GB5.4KS	NSM8XS	5 in 1- Build in	3rd WiFi 2x2 BGN	BT 2.1	8CELL2.4	90W	Italian (KB.I170A.043)	Italian
AS7740G-334G64Mn	EMEA	Italy	AS7740G-334G64Mn W7HP64ATTI1 MC MADISON_PRO1GBCbk_V3 2*2G/640/6L2.4/5R/ CB_GN_0.3D_HG_IT11	Ci3330M	MADISON_PRO	1G-DDR3 (64*16*8)	SO2GBIII10	N640GB5.4KS	NSM8XS	5 in 1- Build in	3rd WiFi 2x2 BGN	N	8CELL2.4	90W	Italian (KB.I170A.043)	Italian
AS7740G-334G32Mn	EMEA	Italy	AS7740G-334G32Mn W7HP64ATTI1 MC MADISON_PRO1GBCbk_V3 2*2G/320/8L2.4/5R/ CB_GN_0.3D_HG_IT11	Ci3330M	MADISON_PRO	1G-DDR3 (64*16*8)	SO2GBIII10	N320GB5.4KS	NSM8XS	5 in 1- Build in	3rd WiFi 2x2 BGN	N	8CELL2.4	90W	Italian (KB.I170A.043)	Italian
AS7740G-438G64Mn	EMEA	Italy	AS7740G-438G64Mn W7HP64ATTI1 MC MADISON_PRO1GBCbk_V3 4G+2G/640/8L2.4/5R/ CB_GN_0.3D_HG_IT11	Ci5430M	MADISON_PRO	1G-DDR3 (64*16*8)	SO4GBIII10 / SO2GBIII10	N640GB5.4KS	NSM8XS	5 in 1- Build in	3rd WiFi 2x2 BGN	N	8CELL2.4	90W	Italian (KB.I170A.043)	Italian
AS7740G-438G64Mn	EMEA	Italy	AS7740G-438G64Mn W7HP64ATTI1 MC MADISON_PRO1GBCbk_V3 2*4G/640/6L2.2/5R/ CB_GN_0.3D_HG_IT11	Ci5430M	MADISON_PRO	1G-DDR3 (64*16*8)	SO4GBIII10	N640GB5.4KS	NSM8XS	5 in 1- Build in	3rd WiFi 2x2 BGN	N	6CELL2.2	90W	Italian (KB.I170A.043)	Italian
AS7740G-434G64Mn	EMEA	Italy	AS7740G-434G64Mn W7HP64ATTI1 MC MADISON_PRO1GBCbk_V3 2*2G/640/6L2.2/5R/ CB_GN_0.3D_HG_IT11	Ci5430M	MADISON_PRO	1G-DDR3 (64*16*8)	SO2GBIII10	N640GB5.4KS	NSM8XS	5 in 1- Build in	3rd WiFi 2x2 BGN	N	6CELL2.2	90W	Italian (KB.I170A.043)	Italian
AS7740G-438G64Mn	EMEA	Hungary	AS7740G-438G64Mn W7HP64ATHU1 MC MADISON_PRO1GBCbk_V3 2*4G/640/6L2.2/5R/ CB_GN_0.3D_HG_HU11	Ci5430M	MADISON_PRO	1G-DDR3 (64*16*8)	SO4GBIII10	N640GB5.4KS	NSM8XS	5 in 1- Build in	3rd WiFi 2x2 BGN	N	6CELL2.2	90W	Hungarian (KB.I170A.042)	Continental
AS7740G-434G64Mn	EMEA	Hungary	AS7740G-434G64Mn W7HP64ATHU1 MC MADISON_PRO1GBCbk_V3 2*2G/640/6L2.2/5R/ CB_GN_0.3D_HG_HU11	Ci5430M	MADISON_PRO	1G-DDR3 (64*16*8)	SO2GBIII10	N640GB5.4KS	NSM8XS	5 in 1- Build in	3rd WiFi 2x2 BGN	N	6CELL2.2	90W	Hungarian (KB.I170A.042)	Continental
AS7740G-628G64Bn	EMEA	Germany	AS7740G-628G64Bn W7HP64ATDE1 MC MADISON_PRO1GBCbk_V3 2*4G/640/8L2.4/5R/ CB_GN_0.3D_HG_DE11	Ci7620M	MADISON_PRO	1G-DDR3 (64*16*8)	SO4GBIII10	N640GB5.4KS	NBDCB4XS	5 in 1- Build in	3rd WiFi 2x2 BGN	BT 2.1	8CELL2.4	90W	German (KB.I170A.040)	Continental
AS7740G-526G64Bn	EMEA	Germany	AS7740G-526G64Bn W7HP64ATDE1 MC MADISON_PRO1GBCbk_V3 4G+2G/640/8L2.4/5R/ CB_GN_0.3D_HG_DE11	Ci5520M	MADISON_PRO	1G-DDR3 (64*16*8)	SO4GBIII10 / SO2GBIII10	N640GB5.4KS	NBDCB4XS	5 in 1- Build in	3rd WiFi 2x2 BGN	BT 2.1	8CELL2.4	90W	German (KB.I170A.040)	Continental
AS7740G-434G50Bn	EMEA	Germany	AS7740G-434G50Bn W7HP64ATDE1 MC MADISON_PRO1GBCbk_V3 2*2G/500_L/6L2.2/5R/ CB_GN_0.3D_HG_DE11	Ci5430M	MADISON_PRO	1G-DDR3 (64*16*8)	SO2GBIII10	N500GB5.4KS	NBDCB4XS	5 in 1- Build in	3rd WiFi 2x2 BGN	N	6CELL2.2	90W	German (KB.I170A.040)	Continental
AS7740G-334G50Mn	EMEA	Germany	AS7740G-334G50Mn W7HP64ATDE1 MC MADISON_PRO1GBCbk_V3 2*2G/500_L/6L2.2/5R/ CB_GN_0.3D_HG_DE11	Ci3330M	MADISON_PRO	1G-DDR3 (64*16*8)	SO2GBIII10	N500GB5.4KS	NSM8XS	5 in 1- Build in	3rd WiFi 2x2 BGN	N	6CELL2.2	90W	German (KB.I170A.040)	Continental
AS7740G-438G64Mn	EMEA	Austria	AS7740G-438G64Mn W7HP64ATAT1 MC MADISON_PRO1GBCbk_V3 2*4G/640/6L2.2/5R/ CB_GN_0.3D_HG_DE61	Ci5430M	MADISON_PRO	1G-DDR3 (64*16*8)	SO4GBIII10	N640GB5.4KS	NSM8XS	5 in 1- Build in	3rd WiFi 2x2 BGN	N	6CELL2.2	90W	German (KB.I170A.040)	Continental
AS7740G-434G64Mn	EMEA	Germany	AS7740G-434G64Mn W7HP64ATDE1 MC MADISON_PRO1GBCbk_V3 2*2G/640/6L2.2/5R/ CB_GN_0.3D_HG_DE11	Ci5430M	MADISON_PRO	1G-DDR3 (64*16*8)	SO2GBIII10	N640GB5.4KS	NSM8XS	5 in 1- Build in	3rd WiFi 2x2 BGN	N	6CELL2.2	90W	German (KB.I170A.040)	Continental

AS7740G-434G64Mn	EMEA	Austria	AS7740G-434G64Mn W7HP64ATAT1 MC MADISON_PRO1GBCbk_V3 2*2G/640/6L2.2/5R/ CB_GN_0.3D_HG_DE61	Ci5430M	MADISON_PRO	1G-DDR3 (64*16*8)	SO2GBIII10	N640GB5.4KS	NSM8XS	5 in 1- Build in	3rd WiFi 2x2 BGN	N	6CELL2.2	90W	German (KB.1170A.040)	Continental
AS7740G-438G64Mn	EMEA	Germany	AS7740G-438G64Mn W7HP64ATDE1 MC MADISON_PRO1GBCbk_V3 2*4G/640/6L2.2/5R/ CB_GN_0.3D_HG_DE11	Ci5430M	MADISON_PRO	1G-DDR3 (64*16*8)	SO4GBIII10	N640GB5.4KS	NSM8XS	5 in 1- Build in	3rd WiFi 2x2 BGN	N	6CELL2.2	90W	German (KB.1170A.040)	Continental
AS7740G-434G64Bn	EMEA	Norway	AS7740G-434G64Bn W7HP64ATNO3 MC MADISON_PRO1GBCbk_V3 2*2G/640/6L2.2/5R/ CB_GN_0.3D_HG_ENS1	Ci5430M	MADISON_PRO	1G-DDR3 (64*16*8)	SO2GBIII10	N640GB5.4KS	NBDCB4XS	5 in 1- Build in	3rd WiFi 2x2 BGN	N	6CELL2.2	90W	Nordic (KB.1170A.045)	Danish/ Continental
AS7740G-336G64Mn	EMEA	Norway	AS7740G-336G64Mn W7HP64ATNO3 MC MADISON_PRO1GBCbk_V3 4G+2G/640/6L2.2/5R/ CB_GN_0.3D_HG_ENS1	Ci3330M	MADISON_PRO	1G-DDR3 (64*16*8)	SO4GBIII10 / SO2GBIII10	N640GB5.4KS	NSM8XS	5 in 1- Build in	3rd WiFi 2x2 BGN	N	6CELL2.2	90W	Nordic (KB.1170A.045)	Danish/ Continental
AS7740G-334G64Mn	EMEA	Norway	AS7740G-334G64Mn W7HP64ATNO3 MC MADISON_PRO1GBCbk_V3 2*2G/640/6L2.2/5R/ CB_GN_0.3D_HG_ENS1	Ci3330M	MADISON_PRO	1G-DDR3 (64*16*8)	SO2GBIII10	N640GB5.4KS	NSM8XS	5 in 1- Build in	3rd WiFi 2x2 BGN	N	6CELL2.2	90W	Nordic (KB.1170A.045)	Danish/ Continental
AS7740G-434G64Bn	EMEA	Denmark	AS7740G-434G64Bn W7HP64ATDK2 MC MADISON_PRO1GBCbk_V3 2*2G/640/6L2.2/5R/ CB_GN_0.3D_HG_ENS1	Ci5430M	MADISON_PRO	1G-DDR3 (64*16*8)	SO2GBIII10	N640GB5.4KS	NBDCB4XS	5 in 1- Build in	3rd WiFi 2x2 BGN	N	6CELL2.2	90W	Nordic (KB.1170A.045)	Danish/ Continental
AS7740G-336G64Mn	EMEA	Denmark	AS7740G-336G64Mn W7HP64ATDK2 MC MADISON_PRO1GBCbk_V3 4G+2G/640/6L2.2/5R/ CB_GN_0.3D_HG_ENS1	Ci3330M	MADISON_PRO	1G-DDR3 (64*16*8)	SO4GBIII10 / SO2GBIII10	N640GB5.4KS	NSM8XS	5 in 1- Build in	3rd WiFi 2x2 BGN	N	6CELL2.2	90W	Nordic (KB.1170A.045)	Danish/ Continental
AS7740G-434G64Mn	EMEA	Denmark	AS7740G-434G64Mn W7HP64ATDK2 MC MADISON_PRO1GBCbk_V3 2*2G/640/6L2.2/5R/ CB_GN_0.3D_HG_ENS1	Ci5430M	MADISON_PRO	1G-DDR3 (64*16*8)	SO2GBIII10	N640GB5.4KS	NSM8XS	5 in 1- Build in	3rd WiFi 2x2 BGN	N	6CELL2.2	90W	Nordic (KB.1170A.045)	Danish/ Continental
AS7740G-438G64Bn	EMEA	Denmark	AS7740G-438G64Bn W7HP64ATDK2 MC MADISON_PRO1GBCbk_V3 2*4G/640/6L2.2/5R/ CB_GN_0.3D_HG_ENS1	Ci5430M	MADISON_PRO	1G-DDR3 (64*16*8)	SO4GBIII10	N640GB5.4KS	NBDCB4XS	5 in 1- Build in	3rd WiFi 2x2 BGN	N	6CELL2.2	90W	Nordic (KB.1170A.045)	Danish/ Continental
AS7740G-438G64Mn	EMEA	Denmark	AS7740G-438G64Mn W7HP64ATDK2 MC MADISON_PRO1GBCbk_V3 2*4G/640/6L2.2/5R/ CB_GN_0.3D_HG_ENS1	Ci5430M	MADISON_PRO	1G-DDR3 (64*16*8)	SO4GBIII10	N640GB5.4KS	NSM8XS	5 in 1- Build in	3rd WiFi 2x2 BGN	N	6CELL2.2	90W	Nordic (KB.1170A.045)	Danish/ Continental
AS7740G-434G64Mn	EMEA	Middle East	AS7740G-434G64Mn EM W7HP64EMATM6 MC MADISON_PRO1GBCbk_V3 2*2G/640/6L2.2/5R/ CB_GN_0.3D_HG_ES61	Ci5430M	MADISON_PRO	1G-DDR3 (64*16*8)	SO2GBIII10	N640GB5.4KS	NSM8XS	5 in 1- Build in	3rd WiFi 2x2 BGN	N	6CELL2.2	90W	US International (KB.1170A.056)	UK
AS7740G-434G64Mn	EMEA	South Africa	AS7740G-434G64Mn EM W7HP64EMATZ4 MC MADISON_PRO1GBCbk_V3 2*2G/640/6L2.2/5R/ CB_GN_0.3D_HG_ES61	Ci5430M	MADISON_PRO	1G-DDR3 (64*16*8)	SO2GBIII10	N640GB5.4KS	NSM8XS	5 in 1- Build in	3rd WiFi 2x2 BGN	N	6CELL2.2	90W	US International (KB.1170A.056)	UK
AS7740G-438G64Mn	EMEA	Middle East	AS7740G-438G64Mn EM W7HP64EMATM6 MC MADISON_PRO1GBCbk_V3 2*4G/640/6L2.2/5R/ CB_GN_0.3D_HG_ES61	Ci5430M	MADISON_PRO	1G-DDR3 (64*16*8)	SO4GBIII10	N640GB5.4KS	NSM8XS	5 in 1- Build in	3rd WiFi 2x2 BGN	N	6CELL2.2	90W	US International (KB.1170A.056)	UK
AS7740G-438G64Mn	EMEA	South Africa	AS7740G-438G64Mn EM W7HP64EMATZ4 MC MADISON_PRO1GBCbk_V3 2*4G/640/6L2.2/5R/ CB_GN_0.3D_HG_ES61	Ci5430M	MADISON_PRO	1G-DDR3 (64*16*8)	SO4GBIII10	N640GB5.4KS	NSM8XS	5 in 1- Build in	3rd WiFi 2x2 BGN	N	6CELL2.2	90W	US International (KB.1170A.056)	UK
AS7740G-434G64Mn	EMEA	South Africa	AS7740G-434G64Mn EM W7HP64EMATZ2 MC MADISON_PRO1GBCbk_V3 2*2G/640/6L2.2/5R/ CB_GN_0.3D_HG_ES61	Ci5430M	MADISON_PRO	1G-DDR3 (64*16*8)	SO2GBIII10	N640GB5.4KS	NSM8XS	5 in 1- Build in	3rd WiFi 2x2 BGN	N	6CELL2.2	90W	US International (KB.1170A.056)	AF
AS7740G-438G64Mn	EMEA	South Africa	AS7740G-438G64Mn EM W7HP64EMATZ2 MC MADISON_PRO1GBCbk_V3 2*4G/640/6L2.2/5R/ CB_GN_0.3D_HG_ES61	Ci5430M	MADISON_PRO	1G-DDR3 (64*16*8)	SO4GBIII10	N640GB5.4KS	NSM8XS	5 in 1- Build in	3rd WiFi 2x2 BGN	N	6CELL2.2	90W	US International (KB.1170A.056)	AF
AS7740G-434G64Mn	EMEA	Poland	AS7740G-434G64Mn W7HP64ATPL1 MC MADISON_PRO1GBCbk_V3 2*2G/640/6L2.2/5R/ CB_GN_0.3D_HG_PL11	Ci5430M	MADISON_PRO	1G-DDR3 (64*16*8)	SO2GBIII10	N640GB5.4KS	NSM8XS	5 in 1- Build in	3rd WiFi 2x2 BGN	N	6CELL2.2	90W	US International (KB.1170A.056)	Continental
AS7740G-434G64Mn	EMEA	Holland	AS7740G-434G64Mn W7HP64ATNL1 MC MADISON_PRO1GBCbk_V3 2*2G/640/6L2.2/5R/ CB_GN_0.3D_HG_NL11	Ci5430M	MADISON_PRO	1G-DDR3 (64*16*8)	SO2GBIII10	N640GB5.4KS	NSM8XS	5 in 1- Build in	3rd WiFi 2x2 BGN	N	6CELL2.2	90W	US International (KB.1170A.056)	Continental
AS7740G-434G64Mn	EMEA	Eastern Europe	AS7740G-434G64Mn W7HP64ATEU5 MC MADISON_PRO1GBCbk_V3 2*2G/640/6L2.2/5R/ CB_GN_0.3D_HG_RO11	Ci5430M	MADISON_PRO	1G-DDR3 (64*16*8)	SO2GBIII10	N640GB5.4KS	NSM8XS	5 in 1- Build in	3rd WiFi 2x2 BGN	N	6CELL2.2	90W	US International (KB.1170A.056)	Continental
AS7740G-434G64Mn	EMEA	Eastern Europe	AS7740G-434G64Mn W7HP64ATEU5 MC MADISON_PRO1GBCbk_V3 2*2G/640/6L2.2/5R/ CB_GN_0.3D_HG_PL71	Ci5430M	MADISON_PRO	1G-DDR3 (64*16*8)	SO2GBIII10	N640GB5.4KS	NSM8XS	5 in 1- Build in	3rd WiFi 2x2 BGN	N	6CELL2.2	90W	US International (KB.1170A.056)	Continental
AS7740G-438G64Mn	EMEA	Poland	AS7740G-438G64Mn W7HP64ATPL1 MC MADISON_PRO1GBCbk_V3 2*4G/640/6L2.2/5R/ CB_GN_0.3D_HG_PL11	Ci5430M	MADISON_PRO	1G-DDR3 (64*16*8)	SO4GBIII10	N640GB5.4KS	NSM8XS	5 in 1- Build in	3rd WiFi 2x2 BGN	N	6CELL2.2	90W	US International (KB.1170A.056)	Continental

AS7740G-438G64Mn	EMEA	Holland	AS7740G-438G64Mn W7HP64ATNL1 MC MADISON_PRO1GBCbk_V3 2*4G/640/6L2.2/5R/ CB_GN_0.3D_HG_NL11	Ci5430M	MADISON_PRO	1G-DDR3 (64*16*8)	SO4GBIII10	N640GB5.4KS	NSM8XS	5 in 1- Build in	3rd WiFi 2x2 BGN	N	6CELL2.2	90W	US International (KB.I170A.056)	Continental
AS7740G-438G64Mn	EMEA	Eastern Europe	AS7740G-438G64Mn W7HP64ATEU5 MC MADISON_PRO1GBCbk_V3 2*4G/640/6L2.2/5R/ CB_GN_0.3D_HG_RO11	Ci5430M	MADISON_PRO	1G-DDR3 (64*16*8)	SO4GBIII10	N640GB5.4KS	NSM8XS	5 in 1- Build in	3rd WiFi 2x2 BGN	N	6CELL2.2	90W	US International (KB.I170A.056)	Continental
AS7740G-438G64Mn	EMEA	Eastern Europe	AS7740G-438G64Mn W7HP64ATEU5 MC MADISON_PRO1GBCbk_V3 2*4G/640/6L2.2/5R/ CB_GN_0.3D_HG_PL71	Ci5430M	MADISON_PRO	1G-DDR3 (64*16*8)	SO4GBIII10	N640GB5.4KS	NSM8XS	5 in 1- Build in	3rd WiFi 2x2 BGN	N	6CELL2.2	90W	US International (KB.I170A.056)	Continental
AS7740G-434G50Mn	PA	USA	AS7740G-434G50Mn W7HP64ATUS1 MC MADISON_PRO1GBCbk_V3 2*2G/500_L/6L2.2/5R/ CB_GN_0.3D_HG_FRB1	Ci5430M	MADISON_PRO	1G-DDR3 (64*16*8)	SO2GBIII10	N500GB5.4KS	NSM8XS	5 in 1- Build in	3rd WiFi 2x2 BGN	N	6CELL2.2	90W	US International (KB.I170A.056)	US-110V
AS7740G-334G50Mn	PA	USA	AS7740G-334G50Mn W7HP64ATUS1 MC MADISON_PRO1GBCbk_V3 2*2G/500_L/6L2.2/5R/ CB_GN_0.3D_HG_FRB1	Ci3330M	MADISON_PRO	1G-DDR3 (64*16*8)	SO2GBIII10	N500GB5.4KS	NSM8XS	5 in 1- Build in	3rd WiFi 2x2 BGN	N	6CELL2.2	90W	US International (KB.I170A.056)	US-110V
AS7740G-626G64Mn	PA	USA	AS7740G-626G64Mn W7HP64ATUS1 MC MADISON_PRO1GBCbk_V3 4G+2G/640/6L2.2/5R/ CB_GN_0.3D_HG_FRB1	Ci7620M	MADISON_PRO	1G-DDR3 (64*16*8)	SO4GBIII10 / SO2GBIII10	N640GB5.4KS	NSM8XS	5 in 1- Build in	3rd WiFi 2x2 BGN	N	6CELL2.2	90W	US International (KB.I170A.056)	US-110V
AS7740G-626G64Mn	PA	USA	AS7740G-626G64Mn W7HP64ATUS1 MC MADISON_PRO1GBCbk_V3 2*4G/640/6L2.2/5R/ CB_GN_0.3D_HG_FRB1	Ci7620M	MADISON_PRO	1G-DDR3 (64*16*8)	SO4GBIII10	N640GB5.4KS	NSM8XS	5 in 1- Build in	3rd WiFi 2x2 BGN	N	6CELL2.2	90W	US International (KB.I170A.056)	US-110V
AS7740G-626G50Mn	PA	USA	AS7740G-626G50Mn W7HP64ATUS1 MC MADISON_PRO1GBCbk_V3 4G+2G/500_L/6L2.2/5R/ CB_GN_0.3D_HG_FRB1	Ci7620M	MADISON_PRO	1G-DDR3 (64*16*8)	SO4GBIII10	N500GB5.4KS	NSM8XS	5 in 1- Build in	3rd WiFi 2x2 BGN	N	6CELL2.2	90W	US International (KB.I170A.056)	US-110V
AS7740G-434G64Mn	EMEA	South Africa	AS7740G-434G64Mn EM W7HP64EMATZA1 MC MADISON_PRO1GBCbk_V3 2*2G/640/6L2.2/5R/ CB_GN_0.3D_HG_ES81	Ci5430M	MADISON_PRO	1G-DDR3 (64*16*8)	SO2GBIII10	N640GB5.4KS	NSM8XS	5 in 1- Build in	3rd WiFi 2x2 BGN	N	6CELL2.2	90W	French (KB.I170A.039)	Continental
AS7740G-434G64Mn	EMEA	Middle East	AS7740G-434G64Mn EM W7HP64EMATME3 MC MADISON_PRO1GBCbk_V3 2*2G/640/6L2.2/5R/ CB_GN_0.3D_HG_ES81	Ci5430M	MADISON_PRO	1G-DDR3 (64*16*8)	SO2GBIII10	N640GB5.4KS	NSM8XS	5 in 1- Build in	3rd WiFi 2x2 BGN	N	6CELL2.2	90W	French (KB.I170A.039)	Continental
AS7740G-438G64Mn	EMEA	South Africa	AS7740G-438G64Mn EM W7HP64EMATZA1 MC MADISON_PRO1GBCbk_V3 2*4G/640/6L2.2/5R/ CB_GN_0.3D_HG_ES81	Ci5430M	MADISON_PRO	1G-DDR3 (64*16*8)	SO4GBIII10	N640GB5.4KS	NSM8XS	5 in 1- Build in	3rd WiFi 2x2 BGN	N	6CELL2.2	90W	French (KB.I170A.039)	Continental
AS7740G-438G64Mn	EMEA	Middle East	AS7740G-438G64Mn EM W7HP64EMATME3 MC MADISON_PRO1GBCbk_V3 2*4G/640/6L2.2/5R/ CB_GN_0.3D_HG_ES81	Ci5430M	MADISON_PRO	1G-DDR3 (64*16*8)	SO4GBIII10	N640GB5.4KS	NSM8XS	5 in 1- Build in	3rd WiFi 2x2 BGN	N	6CELL2.2	90W	French (KB.I170A.039)	Continental
AS7740G-334G50Mn	EMEA	France	AS7740G-334G50Mn W7HP64ATFR1 MC MADISON_PRO1GBCbk_V3 2*2G/500_L/6L2.2/5R/ CB_GN_0.3D_HG_FR21	Ci3330M	MADISON_PRO	1G-DDR3 (64*16*8)	SO2GBIII10	N500GB5.4KS	NSM8XS	5 in 1- Build in	3rd WiFi 2x2 BGN	N	6CELL2.2	90W	French (KB.I170A.039)	Continental
AS7740G-338G50Mn	EMEA	France	AS7740G-338G50Mn W7HP64ATFR1 MC MADISON_PRO1GBCbk_V3 2*4G/600_L/6L2.2/5R/ CB_GN_0.3D_HG_FR21	Ci3330M	MADISON_PRO	1G-DDR3 (64*16*8)	SO4GBIII10	N500GB5.4KS	NSM8XS	5 in 1- Build in	3rd WiFi 2x2 BGN	N	6CELL2.2	90W	French (KB.I170A.039)	Continental
AS7740G-438G64Mn	EMEA	France	AS7740G-438G64Mn W7HP64ATFR1 MC MADISON_PRO1GBCbk_V3 2*4G/640/6L2.2/5R/ CB_GN_0.3D_HG_FR21	Ci5430M	MADISON_PRO	1G-DDR3 (64*16*8)	SO4GBIII10	N640GB5.4KS	NSM8XS	5 in 1- Build in	3rd WiFi 2x2 BGN	N	6CELL2.2	90W	French (KB.I170A.039)	Continental
AS7740G-436G64Mn	EMEA	France	AS7740G-436G64Mn W7HP64ATFR1 MC MADISON_PRO1GBCbk_V3 4G+2G/640/6L2.2/5R/ CB_GN_0.3D_HG_FR21	Ci5430M	MADISON_PRO	1G-DDR3 (64*16*8)	SO4GBIII10 / SO2GBIII10	N640GB5.4KS	NSM8XS	5 in 1- Build in	3rd WiFi 2x2 BGN	N	6CELL2.2	90W	French (KB.I170A.039)	Continental
AS7740G-434G50Mn	EMEA	France	AS7740G-434G50Mn W7HP64ATFR1 MC MADISON_PRO1GBCbk_V3 2*2G/500_L/6L2.2/5R/ CB_GN_0.3D_HG_FR21	Ci5430M	MADISON_PRO	1G-DDR3 (64*16*8)	SO2GBIII10	N500GB5.4KS	NSM8XS	5 in 1- Build in	3rd WiFi 2x2 BGN	N	6CELL2.2	90W	French (KB.I170A.039)	Continental
AS7740G-434G64Mn	EMEA	France	AS7740G-434G64Mn W7HP64ATFR1 MC MADISON_PRO1GBCbk_V3 2*2G/640/6L2.2/5R/ CB_GN_0.3D_HG_FR21	Ci5430M	MADISON_PRO	1G-DDR3 (64*16*8)	SO2GBIII10	N640GB5.4KS	NSM8XS	5 in 1- Build in	3rd WiFi 2x2 BGN	N	6CELL2.2	90W	French (KB.I170A.039)	Continental
AS7740G-438G64Mn	EMEA	Portugal	AS7740G-438G64Mn W7HP64ATPT1 MC MADISON_PRO1GBCbk_V3 2*4G/640/6L2.2/5R/ CB_GN_0.3D_HG_PT11	Ci5430M	MADISON_PRO	1G-DDR3 (64*16*8)	SO4GBIII10	N640GB5.4KS	NSM8XS	5 in 1- Build in	3rd WiFi 2x2 BGN	N	6CELL2.2	90W	Portuguese (KB.I170A.047)	Continental
AS7740G-434G64Mn	EMEA	Portugal	AS7740G-434G64Mn W7HP64ATPT1 MC MADISON_PRO1GBCbk_V3 2*2G/640/6L2.2/5R/ CB_GN_0.3D_HG_PT11	Ci5430M	MADISON_PRO	1G-DDR3 (64*16*8)	SO2GBIII10	N640GB5.4KS	NSM8XS	5 in 1- Build in	3rd WiFi 2x2 BGN	N	6CELL2.2	90W	Portuguese (KB.I170A.047)	Continental
AS7740G-434G64Mn	EMEA	Algeria	AS7740G-434G64Mn EM W7HP64EMATDZ1 MC MADISON_PRO1GBCbk_V3 2*2G/640/6L2.2/5R/ CB_GN_0.3D_HG_ES81	Ci5430M	MADISON_PRO	1G-DDR3 (64*16*8)	SO2GBIII10	N640GB5.4KS	NSM8XS	5 in 1- Build in	3rd WiFi 2x2 BGN	N	6CELL2.2	90W	FR/Arabic (KB.I170A.038)	Continental

AS7740G-434G64Mn	EMEA	Middle East	AS7740G-434G64Mn Em W7HP64EMATME9 MC MADISON_PRO1GBcbk_V3 2*2G/640/6L2.2/5R/ CB_GN_0_3D_HG_ES81	Ci5430M	MADISON_PRO	1G-DDR3 (64*16*8)	SO2GBIII10	N640GB5.4KS	NSM8XS	5 in 1- Build in	3rd WiFi 2x2 BGN	N	6CELL2.2	90W	FR/Arabic (KB.I170A.038)	Continental
AS7740G-438G64Mn	EMEA	Middle East	AS7740G-438G64Mn Em W7HP64EMATME9 MC MADISON_PRO1GBcbk_V3 2*4G/640/6L2.2/5R/ CB_GN_0_3D_HG_ES81	Ci5430M	MADISON_PRO	1G-DDR3 (64*16*8)	SO4GBIII10	N640GB5.4KS	NSM8XS	5 in 1- Build in	3rd WiFi 2x2 BGN	N	6CELL2.2	90W	FR/Arabic (KB.I170A.038)	Continental
AS7740G-438G64Mn	EMEA	Eastern Europe	AS7740G-438G64Mn W7HP64ATEU7 MC MADISON_PRO1GBcbk_V3 2*4G/640/6L2.2/5R/ CB_GN_0_3D_HG_ENQ1	Ci5430M	MADISON_PRO	1G-DDR3 (64*16*8)	SO4GBIII10	N640GB5.4KS	NSM8XS	5 in 1- Build in	3rd WiFi 2x2 BGN	N	6CELL2.2	90W	SLO/CRO (KB.I170A.049)	Continental
AS7740G-438G64Mn	EMEA	Eastern Europe	AS7740G-438G64Mn W7HP64ATEU7 MC MADISON_PRO1GBcbk_V3 2*4G/640/6L2.2/5R/ CB_GN_0_3D_HG_SL11	Ci5430M	MADISON_PRO	1G-DDR3 (64*16*8)	SO4GBIII10	N640GB5.4KS	NSM8XS	5 in 1- Build in	3rd WiFi 2x2 BGN	N	6CELL2.2	90W	SLO/CRO (KB.I170A.049)	Continental
AS7740G-434G64Mn	EMEA	Eastern Europe	AS7740G-434G64Mn W7HP64ATEU7 MC MADISON_PRO1GBcbk_V3 2*2G/640/6L2.2/5R/ CB_GN_0_3D_HG_ENQ1	Ci5430M	MADISON_PRO	1G-DDR3 (64*16*8)	SO2GBIII10	N640GB5.4KS	NSM8XS	5 in 1- Build in	3rd WiFi 2x2 BGN	N	6CELL2.2	90W	SLO/CRO (KB.I170A.049)	Continental
AS7740G-434G64Mn	EMEA	Serbia/ Macedonia	AS7740G-434G64Mn W7HP64ATCS1 MC MADISON_PRO1GBcbk_V3 2*2G/640/6L2.2/5R/ CB_GN_0_3D_HG_SL11	Ci5430M	MADISON_PRO	1G-DDR3 (64*16*8)	SO2GBIII10	N640GB5.4KS	NSM8XS	5 in 1- Build in	3rd WiFi 2x2 BGN	N	6CELL2.2	90W	SLO/CRO (KB.I170A.049)	Continental
AS7740G-434G64Mn	EMEA	Eastern Europe	AS7740G-434G64Mn W7HP64ATEU7 MC MADISON_PRO1GBcbk_V3 2*2G/640/6L2.2/5R/ CB_GN_0_3D_HG_SL11	Ci5430M	MADISON_PRO	1G-DDR3 (64*16*8)	SO2GBIII10	N640GB5.4KS	NSM8XS	5 in 1- Build in	3rd WiFi 2x2 BGN	N	6CELL2.2	90W	SLO/CRO (KB.I170A.049)	Continental
AS7740G-438G64Mn	EMEA	Serbia/ Macedonia	AS7740G-438G64Mn W7HP64ATCS1 MC MADISON_PRO1GBcbk_V3 2*4G/640/6L2.2/5R/ CB_GN_0_3D_HG_SL11	Ci5430M	MADISON_PRO	1G-DDR3 (64*16*8)	SO4GBIII10	N640GB5.4KS	NSM8XS	5 in 1- Build in	3rd WiFi 2x2 BGN	N	6CELL2.2	90W	SLO/CRO (KB.I170A.049)	Continental
AS7740G-434G64Mn	EMEA	Czech	AS7740G-434G64Mn W7HP64ATCZ2 MC MADISON_PRO1GBcbk_V3 2*2G/640/6L2.2/5R/ CB_GN_0_3D_HG_SK11	Ci5430M	MADISON_PRO	1G-DDR3 (64*16*8)	SO2GBIII10	N640GB5.4KS	NSM8XS	5 in 1- Build in	3rd WiFi 2x2 BGN	N	6CELL2.2	90W	CZ/SK (KB.I170A.035)	Continental
AS7740G-438G64Mn	EMEA	Czech	AS7740G-438G64Mn W7HP64ATCZ2 MC MADISON_PRO1GBcbk_V3 2*4G/640/6L2.2/5R/ CB_GN_0_3D_HG_SK11	Ci5430M	MADISON_PRO	1G-DDR3 (64*16*8)	SO4GBIII10	N640GB5.4KS	NSM8XS	5 in 1- Build in	3rd WiFi 2x2 BGN	N	6CELL2.2	90W	CZ/SK (KB.I170A.035)	Continental
AS7740G-338G64Mn	EMEA	Spain	AS7740G-338G64Mn W7HP64ATES1 MC MADISON_PRO1GBcbk_V3 2*4G/640/8L2.4/5R/ CB_GN_0_3D_HG_ES51	Ci3330M	MADISON_PRO	1G-DDR3 (64*16*8)	SO4GBIII10	N640GB5.4KS	NSM8XS	5 in 1- Build in	3rd WiFi 2x2 BGN	N	8CELL2.4	90W	Spanish (KB.I170A.050)	Continental
AS7740G-336G50Mn	EMEA	Spain	AS7740G-336G50Mn W7HP64ATES1 MC MADISON_PRO1GBcbk_V3 4G+2G/500_L/8L2.4/5R/ CB_GN_0_3D_HG_ES51	Ci3330M	MADISON_PRO	1G-DDR3 (64*16*8)	SO4GBIII10 / SO2GBIII10	N500GB5.4KS	NSM8XS	5 in 1- Build in	3rd WiFi 2x2 BGN	N	8CELL2.4	90W	Spanish (KB.I170A.050)	Continental
AS7740G-438G64Mn	EMEA	Spain	AS7740G-438G64Mn W7HP64ATES1 MC MADISON_PRO1GBcbk_V3 2*4G/640/6L2.2/5R/ CB_GN_0_3D_HG_ES51	Ci5430M	MADISON_PRO	1G-DDR3 (64*16*8)	SO4GBIII10	N640GB5.4KS	NSM8XS	5 in 1- Build in	3rd WiFi 2x2 BGN	N	6CELL2.2	90W	Spanish (KB.I170A.050)	Continental
AS7740G-434G64Mn	EMEA	Spain	AS7740G-434G64Mn W7HP64ATES1 MC MADISON_PRO1GBcbk_V3 2*2G/640/6L2.2/5R/ CB_GN_0_3D_HG_ES51	Ci5430M	MADISON_PRO	1G-DDR3 (64*16*8)	SO2GBIII10	N640GB5.4KS	NSM8XS	5 in 1- Build in	3rd WiFi 2x2 BGN	N	6CELL2.2	90W	Spanish (KB.I170A.050)	Continental
AS7740G-436G64Mn	EMEA	Cyprus	AS7740G-436G64Mn W7HP64ATCY1 MC MADISON_PRO1GBcbk_V3 4G+2G/640/8L2.4/5R/ CB_GN_0_3D_HG_ES61	Ci5430M	MADISON_PRO	1G-DDR3 (64*16*8)	SO4GBIII10 / SO2GBIII10	N640GB5.4KS	NSM8XS	5 in 1- Build in	3rd WiFi 2x2 BGN	N	8CELL2.4	90W	UK (KB.I170A.055)	UK
AS7740G-528G64Mn	EMEA	UK	AS7740G-528G64Mn W7HP64ATGB1 MC MADISON_PRO1GBcbk_V3 2*4G/640/8L2.4/5R/ CB_GN_0_3D_HG_EN11	Ci5520M	MADISON_PRO	1G-DDR3 (64*16*8)	SO4GBIII10	N640GB5.4KS	NSM8XS	5 in 1- Build in	3rd WiFi 2x2 BGN	N	8CELL2.4	90W	UK (KB.I170A.055)	UK
AS7740G-434G50Mn	EMEA	UK	AS7740G-434G50Mn W7HP64ATGB1 MC MADISON_PRO1GBcbk_V3 2*2G/500_L/8L2.4/5R/ CB_GN_0_3D_HG_EN11	Ci5430M	MADISON_PRO	1G-DDR3 (64*16*8)	SO2GBIII10	N500GB5.4KS	NSM8XS	5 in 1- Build in	3rd WiFi 2x2 BGN	N	8CELL2.4	90W	UK (KB.I170A.055)	UK
AS7740G-334G64Mn	EMEA	UK	AS7740G-334G64Mn W7HP64ATGB1 MC MADISON_PRO1GBcbk_V3 2*2G/640/8L2.4/5R/ CB_GN_0_3D_HG_EN11	Ci3330M	MADISON_PRO	1G-DDR3 (64*16*8)	SO2GBIII10	N640GB5.4KS	NSM8XS	5 in 1- Build in	3rd WiFi 2x2 BGN	N	8CELL2.4	90W	UK (KB.I170A.055)	UK
AS7740G-336G50Mn	EMEA	UK	AS7740G-336G50Mn W7HP64ATGB1 MC MADISON_PRO1GBcbk_V3 4G+2G/500_L/8L2.4/5R/ CB_GN_0_3D_HG_EN11	Ci3330M	MADISON_PRO	1G-DDR3 (64*16*8)	SO4GBIII10 / SO2GBIII10	N500GB5.4KS	NSM8XS	5 in 1- Build in	3rd WiFi 2x2 BGN	N	8CELL2.4	90W	UK (KB.I170A.055)	UK
AS7740G-438G64Mn	EMEA	Cyprus	AS7740G-438G64Mn W7HP64ATCY1 MC MADISON_PRO1GBcbk_V3 2*4G/640/6L2.2/5R/ CB_GN_0_3D_HG_ES61	Ci5430M	MADISON_PRO	1G-DDR3 (64*16*8)	SO4GBIII10	N640GB5.4KS	NSM8XS	5 in 1- Build in	3rd WiFi 2x2 BGN	N	6CELL2.2	90W	UK (KB.I170A.055)	UK
AS7740G-434G64Mn	EMEA	UK	AS7740G-434G64Mn W7HP64ATGB1 MC MADISON_PRO1GBcbk_V3 2*2G/640/6L2.2/5R/ CB_GN_0_3D_HG_EN11	Ci5430M	MADISON_PRO	1G-DDR3 (64*16*8)	SO2GBIII10	N640GB5.4KS	NSM8XS	5 in 1- Build in	3rd WiFi 2x2 BGN	N	6CELL2.2	90W	UK (KB.I170A.055)	UK

AS7740G-434G64Mn	EMEA	Cyprus	AS7740G-434G64Mn W7HP64ATCY1 MC MADISON_PRO1GBCbk_V3 2*2G/640/6L2.2/5R/ CB_GN_0_3D_HG_E361	Ci5430M	MADISON_PRO	1G-DDR3 (64*16*8)	SO2GBIII10	N640GB5.4KS	NSM8XS	5 in 1- Build in	3rd WiFi 2x2 BGN	N	6CELL2.2	90W	UK (KB.I170A.055)	UK
AS7740G-438G64Mn	EMEA	UK	AS7740G-438G64Mn W7HP64ATGB1 MC MADISON_PRO1GBCbk_V3 2*4G/640/6L2.2/5R/ CB_GN_0_3D_HG_EN11	Ci5430M	MADISON_PRO	1G-DDR3 (64*16*8)	SO4GBIII10	N640GB5.4KS	NSM8XS	5 in 1- Build in	3rd WiFi 2x2 BGN	N	6CELL2.2	90W	UK (KB.I170A.055)	UK
AS7740G-436G64Mn	EMEA	Israel	AS7740G-436G64Mn W7HP64ATIL1 MC MADISON_PRO1GBCbk_V3 4G+2G/640/8L2.4/5R/ CB_GN_0_3D_HG_HE31	Ci5430M	MADISON_PRO	1G-DDR3 (64*16*8)	SO4GBIII10 / SO2GBIII10	N640GB5.4KS	NSM8XS	5 in 1- Build in	3rd WiFi 2x2 BGN	N	8CELL2.4	90W	US International w/ Hebrew (KB.I170A.057)	Israel
AS7740G-436G64Mn	EMEA	Israel	AS7740G-436G64Mn W7HP64ATIL1 MC MADISON_PRO1GBCbk_V3 4G+2G/640/8L2.4/5R/ CB_GN_0_3D_HG_HE11	Ci5430M	MADISON_PRO	1G-DDR3 (64*16*8)	SO4GBIII10 / SO2GBIII10	N640GB5.4KS	NSM8XS	5 in 1- Build in	3rd WiFi 2x2 BGN	N	8CELL2.4	90W	US International w/ Hebrew (KB.I170A.057)	Israel
AS7740G-438G64Mn	EMEA	Israel	AS7740G-438G64Mn W7HP64ATIL1 MC MADISON_PRO1GBCbk_V3 2*4G/640/6L2.2/5R/ CB_GN_0_3D_HG_HE11	Ci5430M	MADISON_PRO	1G-DDR3 (64*16*8)	SO4GBIII10	N640GB5.4KS	NSM8XS	5 in 1- Build in	3rd WiFi 2x2 BGN	N	6CELL2.2	90W	US International w/ Hebrew (KB.I170A.057)	Israel
AS7740G-434G64Mn	EMEA	Israel	AS7740G-434G64Mn W7HP64ATIL1 MC MADISON_PRO1GBCbk_V3 2*2G/640/6L2.2/5R/ CB_GN_0_3D_HG_HE11	Ci5430M	MADISON_PRO	1G-DDR3 (64*16*8)	SO2GBIII10	N640GB5.4KS	NSM8XS	5 in 1- Build in	3rd WiFi 2x2 BGN	N	6CELL2.2	90W	US International w/ Hebrew (KB.I170A.057)	Israel
AS7740G-434G50Mn	EMEA	Greece	AS7740G-434G50Mn W7HP64ATGR1 MC MADISON_PRO1GBCbk_V3 2*2G/500_L/8L2.4/5R/ CB_GN_0_3D_HG_EL31	Ci5430M	MADISON_PRO	1G-DDR3 (64*16*8)	SO2GBIII10	N500GB5.4KS	NSM8XS	5 in 1- Build in	3rd WiFi 2x2 BGN	N	8CELL2.4	90W	Greek (KB.I170A.041)	Continental
AS7740G-624G50Mn	EMEA	Greece	AS7740G-624G50Mn W7HP64ATGR1 MC MADISON_PRO1GBCbk_V3 2*2G/500_L/8L2.4/5R/ CB_GN_0_3D_HG_EL31	Ci7620M	MADISON_PRO	1G-DDR3 (64*16*8)	SO2GBIII10	N500GB5.4KS	NSM8XS	5 in 1- Build in	3rd WiFi 2x2 BGN	BT 2.1	8CELL2.4	90W	Greek (KB.I170A.041)	Continental
AS7740G-334G64Mn	EMEA	Greece	AS7740G-334G64Mn W7HP64ATGR1 MC MADISON_PRO1GBCbk_V3 2*2G/640/8L2.4/5R/ CB_GN_0_3D_HG_EL31	Ci3330M	MADISON_PRO	1G-DDR3 (64*16*8)	SO2GBIII10	N640GB5.4KS	NSM8XS	5 in 1- Build in	3rd WiFi 2x2 BGN	N	8CELL2.4	90W	Greek (KB.I170A.041)	Continental
AS7740G-334G32Mn	EMEA	Greece	AS7740G-334G32Mn W7HP64ATGR1 MC MADISON_PRO1GBCbk_V3 2*2G/320/8L2.4/5R/ CB_GN_0_3D_HG_EL31	Ci3330M	MADISON_PRO	1G-DDR3 (64*16*8)	SO2GBIII10	N320GB5.4KS	NSM8XS	5 in 1- Build in	3rd WiFi 2x2 BGN	N	8CELL2.4	90W	Greek (KB.I170A.041)	Continental
AS7740G-436G64Mn	EMEA	Greece	AS7740G-436G64Mn W7HP64ATGR1 MC MADISON_PRO1GBCbk_V3 4G+2G/640/8L2.4/5R/ CB_GN_0_3D_HG_EL31	Ci5430M	MADISON_PRO	1G-DDR3 (64*16*8)	SO4GBIII10 / SO2GBIII10	N640GB5.4KS	NSM8XS	5 in 1- Build in	3rd WiFi 2x2 BGN	N	8CELL2.4	90W	Greek (KB.I170A.041)	Continental
AS7740G-624G50Mn	EMEA	Greece	AS7740G-624G50Mn W7HP64ATGR1 MC MADISON_PRO1GBCbk_V3 2*2G/500_L/8L2.4/5R/ CB_GN_0_3D_HG_EL31	Ci7620M	MADISON_PRO	1G-DDR3 (64*16*8)	SO2GBIII10	N500GB5.4KS	NSM8XS	5 in 1- Build in	3rd WiFi 2x2 BGN	N	8CELL2.4	90W	Greek (KB.I170A.041)	Continental
AS7740G-438G64Mn	EMEA	Greece	AS7740G-438G64Mn W7HP64ATGR1 MC MADISON_PRO1GBCbk_V3 2*4G/640/6L2.2/5R/ CB_GN_0_3D_HG_EL31	Ci5430M	MADISON_PRO	1G-DDR3 (64*16*8)	SO4GBIII10	N640GB5.4KS	NSM8XS	5 in 1- Build in	3rd WiFi 2x2 BGN	N	6CELL2.2	90W	Greek (KB.I170A.041)	Continental
AS7740G-434G64Mn	EMEA	Greece	AS7740G-434G64Mn W7HP64ATGR1 MC MADISON_PRO1GBCbk_V3 2*2G/640/6L2.2/5R/ CB_GN_0_3D_HG_EL31	Ci5430M	MADISON_PRO	1G-DDR3 (64*16*8)	SO2GBIII10	N640GB5.4KS	NSM8XS	5 in 1- Build in	3rd WiFi 2x2 BGN	N	6CELL2.2	90W	Greek (KB.I170A.041)	Continental
AS7740G-334G64Mn	EMEA	Finland	AS7740G-334G64Mn W7HP64ATF12 MC MADISON_PRO1GBCbk_V3 2*2G/640/6L2.2/5R/ CB_GN_0_3D_HG_F112	Ci3330M	MADISON_PRO	1G-DDR3 (64*16*8)	SO2GBIII10	N640GB5.4KS	NSM8XS	5 in 1- Build in	3rd WiFi 2x2 BGN	N	6CELL2.2	90W	Sweden (KB.I170A.051)	Continental
AS7740G-334G64Mn	EMEA	Sweden	AS7740G-334G64Mn W7HP64ATSE1 MC MADISON_PRO1GBCbk_V3 2*2G/640/6L2.2/5R/ CB_GN_0_3D_HG_F112	Ci3330M	MADISON_PRO	1G-DDR3 (64*16*8)	SO2GBIII10	N640GB5.4KS	NSM8XS	5 in 1- Build in	3rd WiFi 2x2 BGN	N	6CELL2.2	90W	Sweden (KB.I170A.051)	Continental
AS7740G-434G64Bn	EMEA	Finland	AS7740G-434G64Bn W7HP64ATF12 MC MADISON_PRO1GBCbk_V3 2*2G/640/6L2.2/5R/ CB_GN_0_3D_HG_F112	Ci5430M	MADISON_PRO	1G-DDR3 (64*16*8)	SO2GBIII10	N640GB5.4KS	NBDCB4XS	5 in 1- Build in	3rd WiFi 2x2 BGN	N	6CELL2.2	90W	Sweden (KB.I170A.051)	Continental
AS7740G-434G64Bn	EMEA	Sweden	AS7740G-434G64Bn W7HP64ATSE1 MC MADISON_PRO1GBCbk_V3 2*2G/640/6L2.2/5R/ CB_GN_0_3D_HG_F112	Ci5430M	MADISON_PRO	1G-DDR3 (64*16*8)	SO2GBIII10	N640GB5.4KS	NBDCB4XS	5 in 1- Build in	3rd WiFi 2x2 BGN	N	6CELL2.2	90W	Sweden (KB.I170A.051)	Continental
AS7740G-336G64Mn	EMEA	Finland	AS7740G-336G64Mn W7HP64ATF12 MC MADISON_PRO1GBCbk_V3 4G+2G/640/6L2.2/5R/ CB_GN_0_3D_HG_F112	Ci3330M	MADISON_PRO	1G-DDR3 (64*16*8)	SO4GBIII10 / SO2GBIII10	N640GB5.4KS	NSM8XS	5 in 1- Build in	3rd WiFi 2x2 BGN	N	6CELL2.2	90W	Sweden (KB.I170A.051)	Continental
AS7740G-336G64Mn	EMEA	Sweden	AS7740G-336G64Mn W7HP64ATSE1 MC MADISON_PRO1GBCbk_V3 4G+2G/640/6L2.2/5R/ CB_GN_0_3D_HG_F112	Ci3330M	MADISON_PRO	1G-DDR3 (64*16*8)	SO4GBIII10 / SO2GBIII10	N640GB5.4KS	NSM8XS	5 in 1- Build in	3rd WiFi 2x2 BGN	N	6CELL2.2	90W	Sweden (KB.I170A.051)	Continental
AS7740G-438G64Mn	EMEA	Eastern Europe	AS7740G-438G64Mn W7HP64ATEU4 MC MADISON_PRO1GBCbk_V3 2*4G/640/6L2.2/5R/ CB_GN_0_3D_HG_SV21	Ci5430M	MADISON_PRO	1G-DDR3 (64*16*8)	SO4GBIII10	N640GB5.4KS	NSM8XS	5 in 1- Build in	3rd WiFi 2x2 BGN	N	6CELL2.2	90W	Sweden (KB.I170A.051)	Continental

AS7740G-434G64Mn	EMEA	Eastern Europe	AS7740G-434G64Mn W7HP64ATEU4 MC MADISON_PRO1GBCbk_V3 2*2G/640/6L2.2/5R/ CB_GN_0.3D_HG_SV21	Ci5430M	MADISON_PRO	1G-DDR3 (64*16*8)	SO2GBIII10	N640GB5.4KS	NSM8XS	5 in 1- Build in	3rd WiFi 2x2 BGN	N	6CELL2.2	90W	Sweden (KB.I170A.051)	Continental
AS7740G-438G64Bn	EMEA	Sweden	AS7740G-438G64Bn W7HP64ATSE1 MC MADISON_PRO1GBCbk_V3 2*4G/640/6L2.2/5R/ CB_GN_0.3D_HG_F112	Ci5430M	MADISON_PRO	1G-DDR3 (64*16*8)	SO4GBIII10	N640GB5.4KS	NBDCB4XS	5 in 1- Build in	3rd WiFi 2x2 BGN	N	6CELL2.2	90W	Sweden (KB.I170A.051)	Continental
AS7740G-434G64Mn	EMEA	Luxembourg	AS7740G-434G64Mn W7HP64ATLU3 MC MADISON_PRO1GBCbk_V3 2*2G/640/6L2.2/5R/ CB_GN_0.3D_HG_IT41	Ci5430M	MADISON_PRO	1G-DDR3 (64*16*8)	SO2GBIII10	N640GB5.4KS	NSM8XS	5 in 1- Build in	3rd WiFi 2x2 BGN	N	6CELL2.2	90W	Swiss/G (KB.I170A.052)	Continental
AS7740G-438G64Mn	EMEA	Luxembourg	AS7740G-438G64Mn W7HP64ATLU3 MC MADISON_PRO1GBCbk_V3 2*4G/640/6L2.2/5R/ CB_GN_0.3D_HG_IT41	Ci5430M	MADISON_PRO	1G-DDR3 (64*16*8)	SO4GBIII10	N640GB5.4KS	NSM8XS	5 in 1- Build in	3rd WiFi 2x2 BGN	N	6CELL2.2	90W	Swiss/G (KB.I170A.052)	Continental
AS7740G-438G64Bn	EMEA	Switzerland	AS7740G-438G64Bn W7HP64ATCH1 MC MADISON_PRO1GBCbk_V3 2*4G/640/6L2.2/5R/ CB_GN_0.3D_HG_IT41	Ci5430M	MADISON_PRO	1G-DDR3 (64*16*8)	SO4GBIII10	N640GB5.4KS	NBDCB4XS	5 in 1- Build in	3rd WiFi 2x2 BGN	N	6CELL2.2	90W	Swiss/G (KB.I170A.052)	Swiss
AS7740G-434G64Mn	EMEA	Switzerland	AS7740G-434G64Mn W7HP64ATCH1 MC MADISON_PRO1GBCbk_V3 2*2G/640/6L2.2/5R/ CB_GN_0.3D_HG_IT41	Ci5430M	MADISON_PRO	1G-DDR3 (64*16*8)	SO2GBIII10	N640GB5.4KS	NSM8XS	5 in 1- Build in	3rd WiFi 2x2 BGN	N	6CELL2.2	90W	Swiss/G (KB.I170A.052)	Swiss
AS7740G-438G64Mn	EMEA	Switzerland	AS7740G-438G64Mn W7HP64ATCH1 MC MADISON_PRO1GBCbk_V3 2*4G/640/6L2.2/5R/ CB_GN_0.3D_HG_IT41	Ci5430M	MADISON_PRO	1G-DDR3 (64*16*8)	SO4GBIII10	N640GB5.4KS	NSM8XS	5 in 1- Build in	3rd WiFi 2x2 BGN	N	6CELL2.2	90W	Swiss/G (KB.I170A.052)	Swiss
AS7740G-624G50Bn	WW	WW	AS7740G-624G50Bn W7HP64AWW1 MC MADISON_PRO1GBCbk_V3 2*2G/500_LBT/8L2.4/5R/ CB_bgn_0.3D_HG_ES62	Ci7620M	MADISON_PRO	1G-DDR3 (64*16*8)	SO2GBIII10	N500GB5.4KS	NBDCB4XS	5 in 1- Build in	3rd WiFi 1x2 BGN	BT 2.1	8CELL2.4	90W	US International (KB.I170A.056)	US and Continental
AS7740G-434G50Bi	WW	WW	AS7740G-434G50Bi LINPUSAWW1 MADISON_PRO1GBCbk_V3 2*2G/500_LBT/8L2.4/5R/ CB_abgn_0.3D_HG_EN11	Ci5430M	MADISON_PRO	1G-DDR3 (64*16*8)	SO2GBIII10	N500GB5.4KS	NBDCB4XS	5 in 1- Build in	INT6200H	BT 2.1	8CELL2.4	90W	US International (KB.I170A.056)	US and Continental
AS7740G-434G50Bi	WW	GCTWN	AS7740G-434G50Bi LINPUSAWW1 MADISON_PRO1GBCbk_V3 2*2G/500_LBT/8L2.4/5R/ CB_abgn_0.3D_HG_ENX1	Ci5430M	MADISON_PRO	1G-DDR3 (64*16*8)	SO2GBIII10	N500GB5.4KS	NBDCB4XS	5 in 1- Build in	INT6200H	BT 2.1	8CELL2.4	90W	US International (KB.I170A.056)	US and Continental
AS7740G-434G50Mn	EMEA	Israel	AS7740G-434G50Mn W7HP64ATIL1 MC PARK_XT512Cbk_V3 2*2G/500_L/6L2.2/5R/ CB_bgn_0.3D_HG_HE31	Ci5430M	PARK_XT	512M- DDR3 (64*16*4)	SO2GBIII10	N500GB5.4KS	NSM8XS	5 in 1- Build in	3rd WiFi 2x2 BGN	N	6CELL2.2	65W	US International w/ Hebrew (KB.I170A.057)	Israel
AS7740G-333G25Mi	EMEA	Russia	AS7740G-333G25Mi W7HP64RATRU1 MC PARK_XT512Cbk_V3 2G+1G/250/BT/6L2.2/5R/ CB_bg_0.3D_HG_RU11	Ci3330M	PARK_XT	512M- DDR3 (64*16*4)	SO2GBIII10	N250GB5.4KS	NSM8XS	5 in 1- Build in	3rd WiFi BG	BT 2.1	6CELL2.2	65W	Russian (KB.I170A.048)	Continental
AS7740G-434G50Mn	PA	Canada	AS7740G-434G50Mn W7HP64ATCA2 MC PARK_XT512Cbk_V3 2*2G/500_L/6L2.2/5R/ CB_bgn_0.3D_HG_FR61	Ci5430M	PARK_XT	512M- DDR3 (64*16*4)	SO2GBIII10	N500GB5.4KS	NSM8XS	5 in 1- Build in	3rd WiFi 2x2 BGN	N	6CELL2.2	65W	US w/ Canadian French (KB.I170A.058)	US-110V
AS7740G-334G64Mn	EMEA	Greece	AS7740G-334G64Mn W7HP64ATGR1 MC PARK_XT512Cbk_V3 2*2G/640/6L2.2/5R/ CB_bgn_0.3D_HG_EL31	Ci3330M	PARK_XT	512M- DDR3 (64*16*4)	SO2GBIII10	N640GB5.4KS	NSM8XS	5 in 1- Build in	3rd WiFi 2x2 BGN	N	6CELL2.2	65W	Greek (KB.I170A.041)	Continental
AS7740G-434G50Mn	EMEA	Italy	AS7740G-434G50Mn W7HP64ATIT1 MC PARK_XT512Cbk_V3 2*2G/500_L/6L2.2/5R/ CB_bgn_0.3D_HG_IT11	Ci5430M	PARK_XT	512M- DDR3 (64*16*4)	SO2GBIII10	N500GB5.4KS	NSM8XS	5 in 1- Build in	3rd WiFi 2x2 BGN	N	6CELL2.2	65W	Italian (KB.I170A.043)	Italian
AS7740G-334G50Mn	EMEA	South Africa	AS7740G-334G50Mn Em W7HP64EMATZ2 MC PARK_XT512Cbk_V3 2*2G/500_LBT/6L2.2/5R/ CB_GN_0.3D_HG_ES61	Ci3330M	PARK_XT	512M- DDR3 (64*16*4)	SO2GBIII10	N500GB5.4KS	NSM8XS	5 in 1- Build in	3rd WiFi 2x2 BGN	BT 2.1	6CELL2.2	65W	US International (KB.I170A.056)	AF
AS7740G-334G32Mn	EMEA	Denmark	AS7740G-334G32Mn W7HP64ATDK2 MC PARK_XT512Cbk_V3 2*2G/320/6L2.2/5R/ CB_GN_0.3D_HG_ENS1	Ci3330M	PARK_XT	512M- DDR3 (64*16*4)	SO2GBIII10	N320GB5.4KS	NSM8XS	5 in 1- Build in	3rd WiFi 2x2 BGN	N	6CELL2.2	65W	Nordic (KB.I170A.045)	Danish/ Continental
AS7740G-334G64Mn	EMEA	Spain	AS7740G-334G64Mn W7HP64ATES1 MC PARK_XT512Cbk_V3 2*2G/640/6L2.2/5R/ CB_GN_0.3D_HG_ES51	Ci3330M	PARK_XT	512M- DDR3 (64*16*4)	SO2GBIII10	N640GB5.4KS	NSM8XS	5 in 1- Build in	3rd WiFi 2x2 BGN	N	8CELL2.4	65W	Spanish (KB.I170A.050)	Continental
AS7740G-334G32Mn	EMEA	Sweden	AS7740G-334G32Mn W7HP64ATSE1 MC PARK_XT512Cbk_V3 2*2G/320/6L2.2/5R/ CB_GN_0.3D_HG_F112	Ci3330M	PARK_XT	512M- DDR3 (64*16*4)	SO2GBIII10	N320GB5.4KS	NSM8XS	5 in 1- Build in	3rd WiFi 2x2 BGN	N	6CELL2.2	65W	Sweden (KB.I170A.051)	Continental
AS7740G-334G32Mn	EMEA	Finland	AS7740G-334G32Mn W7HP64ATF12 MC PARK_XT512Cbk_V3 2*2G/320/6L2.2/5R/ CB_GN_0.3D_HG_F112	Ci3330M	PARK_XT	512M- DDR3 (64*16*4)	SO2GBIII10	N320GB5.4KS	NSM8XS	5 in 1- Build in	3rd WiFi 2x2 BGN	N	6CELL2.2	65W	Sweden (KB.I170A.051)	Continental
AS7740G-334G32Mn	EMEA	France	AS7740G-334G32Mn W7HP64ATFR1 MC PARK_XT512Cbk_V3 2*2G/320/6L2.2/5R/ CB_GN_0.3D_HG_FR21	Ci3330M	PARK_XT	512M- DDR3 (64*16*4)	SO2GBIII10	N320GB5.4KS	NSM8XS	5 in 1- Build in	3rd WiFi 2x2 BGN	N	6CELL2.2	65W	French (KB.I170A.039)	Continental

AS7740G-334G32Mn	EMEA	Norway	AS7740G-334G32Mn W7HP64ATN03 MC PARK_XT512CbK_V3 2*2G/320/6L2.2/5R/CB_GN_0.3D_HG_EN51	Ci3330M	PARK_XT	512M-DDR3 (64*16*4)	SO2GBIII10	N320GB5.4KS	NSM8XS	5 in 1-Build in	3rd WiFi 2x2 BGN	N	6CELL2.2	65W	Nordic (KB.I170A.045)	Danish/Continental
AS7740G-434G50Mn	PA	Canada	AS7740G-434G50Mn W7HP64ATCA2 MC PARK_XT512CbK_V3 2*2G/500_L/8L2.4/5R/CB_GN_0.3D_HG_FR81	Ci5430M	PARK_XT	512M-DDR3 (64*16*4)	SO2GBIII10	N500GB5.4KS	NSM8XS	5 in 1-Build in	3rd WiFi 2x2 BGN	N	8CELL2.4	65W	US w/ Canadian French (KB.I170A.058)	US-110V
AS7740G-524G50Bn	WW	GCTWN	AS7740G-524G50Bn LNPUSAWW1 PARK_XT512CbK_V3 2*2G/500_L/8L2.4/5R/CB_bgn_0.3D_HG_ENX1	Ci5520M	PARK_XT	512M-DDR3 (64*16*4)	SO2GBIII10	N500GB5.4KS	NBDCB4XS	5 in 1-Build in	INT1000H	BT 2.1	8CELL2.4	90W	US International (KB.I170A.056)	US and Continental
AS7740G-524G50Bn	WW	WW	AS7740G-524G50Bn LNPUSAWW1 PARK_XT512CbK_V3 2*2G/500_L/8L2.4/5R/CB_bgn_0.3D_HG_EN11	Ci5520M	PARK_XT	512M-DDR3 (64*16*4)	SO2GBIII10	N500GB5.4KS	NBDCB4XS	5 in 1-Build in	INT1000H	BT 2.1	8CELL2.4	90W	US International (KB.I170A.056)	US and Continental
AS7740-334G32Mn	EMEA	Greece	AS7740-334G32Mn W7HP64ATGR1 MC UMACbk 2*2G/320/6L2.2/5R/CB_bgn_0.3D_HG_EL31	Ci3330M	UMA	N	SO2GBIII10	N320GB5.4KS	NSM8XS	5 in 1-Build in	3rd WiFi 2x2 BGN	N	6CELL2.2	65W	Greek (KB.I170A.041)	Continental
AS7740-334G32Mn	EMEA	Eastern Europe	AS7740-334G32Mn W7HP64ATEU7 MC UMACbk 2*2G/320/6L2.2/5R/CB_bgn_0.3D_HG_SL11	Ci3330M	UMA	N	SO2GBIII10	N320GB5.4KS	NSM8XS	5 in 1-Build in	3rd WiFi 2x2 BGN	N	6CELL2.2	65W	SLO/CRO (KB.I170A.049)	Continental
AS7740-334G32Mn	EMEA	Belgium	AS7740-334G32Mn W7HP64ATBE1 MC UMACbk 2*2G/320/6L2.2/5R/CB_bgn_0.3D_HG_NL11	Ci3330M	UMA	N	SO2GBIII10	N320GB5.4KS	NSM8XS	5 in 1-Build in	3rd WiFi 2x2 BGN	N	6CELL2.2	65W	Belgium (KB.I170A.033)	Continental
AS7740-334G32Mn	EMEA	Turkey	AS7740-334G32Mn EM W7HP64EMATTR1 MC UMACbk 2*2G/320/6L2.2/5R/CB_bgn_0.3D_HG_TR31	Ci3330M	UMA	N	SO2GBIII10	N320GB5.4KS	NSM8XS	5 in 1-Build in	3rd WiFi 2x2 BGN	N	6CELL2.2	65W	Turkish (KB.I170A.054)	Continental
AS7740-334G32Mn	EMEA	Germany	AS7740-334G32Mn W7HP64ATDE1 MC UMACbk 2*2G/320/6L2.2/5R/CB_bgn_0.3D_HG_DE11	Ci3330M	UMA	N	SO2GBIII10	N320GB5.4KS	NSM8XS	5 in 1-Build in	3rd WiFi 2x2 BGN	N	6CELL2.2	65W	German (KB.I170A.040)	Continental
AS7740-334G32Mn	EMEA	Austria	AS7740-334G32Mn W7HP64ATAT1 MC UMACbk 2*2G/320/6L2.2/5R/CB_bgn_0.3D_HG_DE61	Ci3330M	UMA	N	SO2GBIII10	N320GB5.4KS	NSM8XS	5 in 1-Build in	3rd WiFi 2x2 BGN	N	6CELL2.2	65W	German (KB.I170A.040)	Continental
AS7740-334G32Mn	EMEA	Eastern Europe	AS7740-334G32Mn W7HP64ATEU4 MC UMACbk 2*2G/320/6L2.2/5R/CB_bgn_0.3D_HG_SV21	Ci3330M	UMA	N	SO2GBIII10	N320GB5.4KS	NSM8XS	5 in 1-Build in	3rd WiFi 2x2 BGN	N	6CELL2.2	65W	Sweden (KB.I170A.051)	Continental
AS7740-334G32Mn	EMEA	Eastern Europe	AS7740-334G32Mn W7HP64ATEU7 MC UMACbk 2*2G/320/6L2.2/5R/CB_bgn_0.3D_HG_ENQ1	Ci3330M	UMA	N	SO2GBIII10	N320GB5.4KS	NSM8XS	5 in 1-Build in	3rd WiFi 2x2 BGN	N	6CELL2.2	65W	SLO/CRO (KB.I170A.049)	Continental
AS7740-334G32Mn	EMEA	Serbia/ Macedonia	AS7740-334G32Mn W7HP64ATCS1 MC UMACbk 2*2G/320/6L2.2/5R/CB_bgn_0.3D_HG_SL11	Ci3330M	UMA	N	SO2GBIII10	N320GB5.4KS	NSM8XS	5 in 1-Build in	3rd WiFi 2x2 BGN	N	6CELL2.2	65W	SLO/CRO (KB.I170A.049)	Continental
AS7740-334G32Mn	EMEA	Portugal	AS7740-334G32Mn W7HP64ATPT1 MC UMACbk 2*2G/320/6L2.2/5R/CB_bgn_0.3D_HG_PT11	Ci3330M	UMA	N	SO2GBIII10	N320GB5.4KS	NSM8XS	5 in 1-Build in	3rd WiFi 2x2 BGN	N	6CELL2.2	65W	Portuguese (KB.I170A.047)	Continental
AS7740-334G32Mn	EMEA	Spain	AS7740-334G32Mn W7HP64ATES1 MC UMACbk 2*2G/320/6L2.2/5R/CB_bgn_0.3D_HG_ES51	Ci3330M	UMA	N	SO2GBIII10	N320GB5.4KS	NSM8XS	5 in 1-Build in	3rd WiFi 2x2 BGN	N	6CELL2.2	65W	Spanish (KB.I170A.050)	Continental
AS7740-334G32Mn	EMEA	Denmark	AS7740-334G32Mn W7HP64ATDK2 MC UMACbk 2*2G/320/6L2.2/5R/CB_bgn_0.3D_HG_ENS1	Ci3330M	UMA	N	SO2GBIII10	N320GB5.4KS	NSM8XS	5 in 1-Build in	3rd WiFi 2x2 BGN	N	6CELL2.2	65W	Nordic (KB.I170A.045)	Danish/Continental
AS7740-334G32Mn	EMEA	Middle East	AS7740-334G32Mn EM W7HP64EMATME3 MC UMACbk 2*2G/320/6L2.2/5R/CB_bgn_0.3D_HG_ES81	Ci3330M	UMA	N	SO2GBIII10	N320GB5.4KS	NSM8XS	5 in 1-Build in	3rd WiFi 2x2 BGN	N	6CELL2.2	65W	French (KB.I170A.039)	Continental
AS7740-334G32Mn	EMEA	South Africa	AS7740-334G32Mn EM W7HP64EMATZA1 MC UMACbk 2*2G/320/6L2.2/5R/CB_bgn_0.3D_HG_ES81	Ci3330M	UMA	N	SO2GBIII10	N320GB5.4KS	NSM8XS	5 in 1-Build in	3rd WiFi 2x2 BGN	N	6CELL2.2	65W	French (KB.I170A.039)	Continental
AS7740-334G32Mn	EMEA	France	AS7740-334G32Mn W7HP64ATFR1 MC UMACbk 2*2G/320/6L2.2/5R/CB_bgn_0.3D_HG_FR21	Ci3330M	UMA	N	SO2GBIII10	N320GB5.4KS	NSM8XS	5 in 1-Build in	3rd WiFi 2x2 BGN	N	6CELL2.2	65W	French (KB.I170A.039)	Continental
AS7740-334G32Mn	EMEA	Middle East	AS7740-334G32Mn EM W7HP64EMATME2 MC UMACbk 2*2G/320/6L2.2/5R/CB_bgn_0.3D_HG_AR11	Ci3330M	UMA	N	SO2GBIII10	N320GB5.4KS	NSM8XS	5 in 1-Build in	3rd WiFi 2x2 BGN	N	6CELL2.2	65W	Arabic (KB.I170A.032)	UK and US-110V
AS7740-334G32Mn	EMEA	UK	AS7740-334G32Mn W7HP64ATGB1 MC UMACbk 2*2G/320/6L2.2/5R/CB_bgn_0.3D_HG_EN11	Ci3330M	UMA	N	SO2GBIII10	N320GB5.4KS	NSM8XS	5 in 1-Build in	3rd WiFi 2x2 BGN	N	6CELL2.2	65W	UK (KB.I170A.055)	UK
AS7740-334G32Mn	EMEA	Cyprus	AS7740-334G32Mn W7HP64ATCY1 MC UMACbk 2*2G/320/6L2.2/5R/CB_bgn_0.3D_HG_ES61	Ci3330M	UMA	N	SO2GBIII10	N320GB5.4KS	NSM8XS	5 in 1-Build in	3rd WiFi 2x2 BGN	N	6CELL2.2	65W	UK (KB.I170A.055)	UK
AS7740-334G32Mn	EMEA	Israel	AS7740-334G32Mn W7HP64ATIL1 MC UMACbk 2*2G/320/6L2.2/5R/CB_bgn_0.3D_HG_HE11	Ci3330M	UMA	N	SO2GBIII10	N320GB5.4KS	NSM8XS	5 in 1-Build in	3rd WiFi 2x2 BGN	N	6CELL2.2	65W	US International w/ Hebrew (KB.I170A.057)	Israel
AS7740-334G32Mn	EMEA	Czech	AS7740-334G32Mn W7HP64ATC22 MC UMACbk 2*2G/320/6L2.2/5R/CB_bgn_0.3D_HG_SK11	Ci3330M	UMA	N	SO2GBIII10	N320GB5.4KS	NSM8XS	5 in 1-Build in	3rd WiFi 2x2 BGN	N	6CELL2.2	65W	CZ/SK (KB.I170A.035)	Continental
AS7740-334G32Mn	EMEA	Middle East	AS7740-334G32Mn EM W7HP64EMATME9 MC UMACbk 2*2G/320/6L2.2/5R/CB_bgn_0.3D_HG_ES81	Ci3330M	UMA	N	SO2GBIII10	N320GB5.4KS	NSM8XS	5 in 1-Build in	3rd WiFi 2x2 BGN	N	6CELL2.2	65W	FR/Arabic (KB.I170A.038)	Continental
AS7740-334G32Mn	EMEA	Algeria	AS7740-334G32Mn EM W7HP64EMATDZ1 MC UMACbk 2*2G/320/6L2.2/5R/CB_bgn_0.3D_HG_ES81	Ci3330M	UMA	N	SO2GBIII10	N320GB5.4KS	NSM8XS	5 in 1-Build in	3rd WiFi 2x2 BGN	N	6CELL2.2	65W	FR/Arabic (KB.I170A.038)	Continental

AS7740-334G32Mn	EMEA	Luxembourg	AS7740-334G32Mn W7HP64ATL U3 MC UMACbk 2*2G/320/6L2.2/5R/CB_bgn_0.3D_HG_IT41	Ci3330M	UMA	N	SO2GBIII10	N320GB5.4KS	NSM8XS	5 in 1-Build in	3rd WiFi 2x2 BGN	N	6CELL2.2	65W	Swiss/G (KB.I170A.052)	Continental
AS7740-334G32Mn	EMEA	Switzerland	AS7740-334G32Mn W7HP64ATCH1 MC UMACbk 2*2G/320/6L2.2/5R/CB_bgn_0.3D_HG_IT41	Ci3330M	UMA	N	SO2GBIII10	N320GB5.4KS	NSM8XS	5 in 1-Build in	3rd WiFi 2x2 BGN	N	6CELL2.2	65W	Swiss/G (KB.I170A.052)	Swiss
AS7740-334G32Mn	EMEA	Hungary	AS7740-334G32Mn W7HP64ATHU1 MC UMACbk 2*2G/320/6L2.2/5R/CB_bgn_0.3D_HG_HU11	Ci3330M	UMA	N	SO2GBIII10	N320GB5.4KS	NSM8XS	5 in 1-Build in	3rd WiFi 2x2 BGN	N	6CELL2.2	65W	Hungarian (KB.I170A.042)	Continental
AS7740-334G32Mn	EMEA	Italy	AS7740-334G32Mn W7HP64ATT1 MC UMACbk 2*2G/320/6L2.2/5R/CB_bgn_0.3D_HG_IT11	Ci3330M	UMA	N	SO2GBIII10	N320GB5.4KS	NSM8XS	5 in 1-Build in	3rd WiFi 2x2 BGN	N	6CELL2.2	65W	Italian (KB.I170A.043)	Italian
AS7740-334G32Mn	EMEA	Middle East	AS7740-334G32Mn EM W7HP64EMATME4 MC UMACbk 2*2G/320/6L2.2/5R/CB_bgn_0.3D_HG_RU61	Ci3330M	UMA	N	SO2GBIII10	N320GB5.4KS	NSM8XS	5 in 1-Build in	3rd WiFi 2x2 BGN	N	6CELL2.2	65W	Russian (KB.I170A.048)	Continental
AS7740-334G32Mn	EMEA	Middle East	AS7740-334G32Mn EM W7HP64EMATME4 MC UMACbk 2*2G/320/6L2.2/5R/CB_bgn_0.3D_HG_ES61	Ci3330M	UMA	N	SO2GBIII10	N320GB5.4KS	NSM8XS	5 in 1-Build in	3rd WiFi 2x2 BGN	N	6CELL2.2	65W	Russian (KB.I170A.048)	Continental
AS7740-334G32Mn	EMEA	Latvia	AS7740-334G32Mn W7HP64ATLV1 MC UMACbk 2*2G/320/6L2.2/5R/CB_bgn_0.3D_HG_RU22	Ci3330M	UMA	N	SO2GBIII10	N320GB5.4KS	NSM8XS	5 in 1-Build in	3rd WiFi 2x2 BGN	N	6CELL2.2	65W	Russian (KB.I170A.048)	Continental
AS7740-334G32Mi	EMEA	Ukraine	AS7740-334G32Mi W7HP64RUATUK1 MC UMACbk 2*2G/320/6L2.2/5R/CB_bgn_0.3D_HG_RU61	Ci3330M	UMA	N	SO2GBIII10	N320GB5.4KS	NSM8XS	5 in 1-Build in	3rd WiFi BG	N	6CELL2.2	65W	Russian (KB.I170A.048)	Continental
AS7740-334G32Mi	EMEA	Russia	AS7740-334G32Mi W7HP64RUATRU1 MC UMACbk 2*2G/320/6L2.2/5R/CB_bgn_0.3D_HG_RU11	Ci3330M	UMA	N	SO2GBIII10	N320GB5.4KS	NSM8XS	5 in 1-Build in	3rd WiFi BG	N	6CELL2.2	65W	Russian (KB.I170A.048)	Continental
AS7740-334G32Mn	EMEA	Middle East	AS7740-334G32Mn EM W7HP64EMATME6 MC UMACbk 2*2G/320/6L2.2/5R/CB_bgn_0.3D_HG_ES61	Ci3330M	UMA	N	SO2GBIII10	N320GB5.4KS	NSM8XS	5 in 1-Build in	3rd WiFi 2x2 BGN	N	6CELL2.2	65W	US International (KB.I170A.056)	UK
AS7740-334G32Mn	EMEA	South Africa	AS7740-334G32Mn EM W7HP64EMATZA2 MC UMACbk 2*2G/320/6L2.2/5R/CB_bgn_0.3D_HG_ES61	Ci3330M	UMA	N	SO2GBIII10	N320GB5.4KS	NSM8XS	5 in 1-Build in	3rd WiFi 2x2 BGN	N	6CELL2.2	65W	US International (KB.I170A.056)	UK
AS7740-334G32Mn	EMEA	South Africa	AS7740-334G32Mn EM W7HP64EMATZA2 MC UMACbk 2*2G/320/6L2.2/5R/CB_bgn_0.3D_HG_ES61	Ci3330M	UMA	N	SO2GBIII10	N320GB5.4KS	NSM8XS	5 in 1-Build in	3rd WiFi 2x2 BGN	N	6CELL2.2	65W	US International (KB.I170A.056)	AF
AS7740-334G32Mn	EMEA	Poland	AS7740-334G32Mn W7HP64ATPL1 MC UMACbk 2*2G/320/6L2.2/5R/CB_bgn_0.3D_HG_PL11	Ci3330M	UMA	N	SO2GBIII10	N320GB5.4KS	NSM8XS	5 in 1-Build in	3rd WiFi 2x2 BGN	N	6CELL2.2	65W	US International (KB.I170A.056)	Continental
AS7740-334G32Mn	EMEA	Holland	AS7740-334G32Mn W7HP64ATNL1 MC UMACbk 2*2G/320/6L2.2/5R/CB_bgn_0.3D_HG_NL11	Ci3330M	UMA	N	SO2GBIII10	N320GB5.4KS	NSM8XS	5 in 1-Build in	3rd WiFi 2x2 BGN	N	6CELL2.2	65W	US International (KB.I170A.056)	Continental
AS7740-334G32Mn	EMEA	Eastern Europe	AS7740-334G32Mn W7HP64ATEU5 MC UMACbk 2*2G/320/6L2.2/5R/CB_bgn_0.3D_HG_RO11	Ci3330M	UMA	N	SO2GBIII10	N320GB5.4KS	NSM8XS	5 in 1-Build in	3rd WiFi 2x2 BGN	N	6CELL2.2	65W	US International (KB.I170A.056)	Continental
AS7740-334G32Mn	EMEA	Eastern Europe	AS7740-334G32Mn W7HP64ATEU5 MC UMACbk 2*2G/320/6L2.2/5R/CB_bgn_0.3D_HG_PL71	Ci3330M	UMA	N	SO2GBIII10	N320GB5.4KS	NSM8XS	5 in 1-Build in	3rd WiFi 2x2 BGN	N	6CELL2.2	65W	US International (KB.I170A.056)	Continental
AS7740-334G32Mn	EMEA	Middle East	AS7740-334G32Mn EM W7HP64EMATME2 MC UMACbk 2*2G/320/6L2.2/5R/CB_bgn_0.3D_HG_ES61	Ci3330M	UMA	N	SO2GBIII10	N320GB5.4KS	NSM8XS	5 in 1-Build in	3rd WiFi 2x2 BGN	N	6CELL2.2	65W	Arabic (KB.I170A.032)	UK and US-110V
AS7740-334G32Mn	EMEA	Middle East	AS7740-334G32Mn EM W7HP64EMATME2 MC UMACbk 2*2G/320/6L2.2/5R/CB_bgn_0.3D_HG_AR21	Ci3330M	UMA	N	SO2GBIII10	N320GB5.4KS	NSM8XS	5 in 1-Build in	3rd WiFi 2x2 BGN	N	6CELL2.2	65W	Arabic (KB.I170A.032)	UK and US-110V
AS7740-334G64Mn	EMEA	Ukraine	AS7740-334G64Mn W7HP64RUATUK1 MC UMACbk 2*2G/640/BT1/6L2.2/5R/CB_GN_0.3D_HG_RU61	Ci3330M	UMA	N	SO2GBIII10	N640GB5.4KS	NSM8XS	5 in 1-Build in	3rd WiFi 2x2 BGN	BT 2.1	6CELL2.2	65W	Russian (KB.I170A.048)	Continental
AS7740-334G32Mn	PA	USA	AS7740-334G32Mn W7HP64ATUS1 MC UMACbk 2*2G/320/6L2.2/5R/CB_GN_0.3D_HG_FRB1	Ci3330M	UMA	N	SO2GBIII10	N320GB5.4KS	NSM8XS	5 in 1-Build in	3rd WiFi 2x2 BGN	N	6CELL2.2	65W	US International (KB.I170A.056)	US-110V
AS7740-334G50Bn	PA	USA	AS7740-334G50Bn W7HP64ATUS1 MC UMACbk 2*2G/500_L/6L2.2/5R/CB_GN_0.3D_HG_FRB5	Ci3330M	UMA	N	SO2GBIII10	N500GB5.4KS	NBDCB4XS	5 in 1-Build in	3rd WiFi 2x2 BGN	N	6CELL2.2	65W	US International (KB.I170A.056)	US-110V
AS7740-334G50Mn	EMEA	UK	AS7740-334G50Mn W7HP64ATGB1 MC UMACbk 2*2G/500_L/6L2.2/5R/CB_GN_0.3D_HG_EN11	Ci3330M	UMA	N	SO2GBIII10	N500GB5.4KS	NSM8XS	5 in 1-Build in	3rd WiFi 2x2 BGN	N	6CELL2.2	65W	UK (KB.I170A.055)	UK
AS7740-334G32Mn	EMEA	UK	AS7740-334G32Mn W7HP64ATGB1 MC UMACbk 2*2G/320/6L2.2/5R/CB_GN_0.3D_HG_EN11	Ci3330M	UMA	N	SO2GBIII10	N320GB5.4KS	NSM8XS	5 in 1-Build in	3rd WiFi 2x2 BGN	N	6CELL2.2	65W	UK (KB.I170A.055)	UK
AS7740-336G50Mn	PA	USA	AS7740-336G50Mn W7HP64ATUS1 MC UMACbk 4G+2G/500_L/6L2.2/5R/CB_GN_0.3D_HG_FRB1	Ci3330M	UMA	N	SO4GBIII10 / SO2GBIII10	N500GB5.4KS	NSM8XS	5 in 1-Build in	3rd WiFi 2x2 BGN	N	6CELL2.2	65W	US International (KB.I170A.056)	US-110V
AS7740-334G50Mn	PA	USA	AS7740-334G50Mn W7HP64ATUS1 MC UMACbk 2*2G/500_L/6L2.2/5R/CB_GN_0.3D_HG_FRB1	Ci3330M	UMA	N	SO2GBIII10	N500GB5.4KS	NSM8XS	5 in 1-Build in	3rd WiFi 2x2 BGN	N	6CELL2.2	65W	US International (KB.I170A.056)	US-110V
AS7740-434G50Mn	PA	USA	AS7740-434G50Mn W7HP64ATUS1 MC UMACbk 2*2G/500_L/6L2.2/5R/CB_GN_0.3D_HG_FRB1	Ci5430M	UMA	N	SO2GBIII10	N500GB5.4KS	NSM8XS	5 in 1-Build in	3rd WiFi 2x2 BGN	N	6CELL2.2	65W	US International (KB.I170A.056)	US-110V
AS7740-012G25Mn	WW	WW	AS7740-012G25Mn W7HP64AWW1 MC UMACbk 2*1G/250/BT/6L2.2/5R/CB_bgn_0.3D_HG_ES82		Dummy CFD/ARD	N	SO1GBIII10	N250GB5.4KS	NSM8XS	5 in 1-Build in	3rd WiFi 1x2 BGN	BT 2.1	6CELL2.2	65W	US International (KB.I170A.056)	US and Continental
AS7740-012G25Mn	WW	GCTWN	AS7740-012G25Mn W7HP64AWW1 MC UMACbk 2*1G/250/BT/6L2.2/5R/CB_bgn_0.3D_HG_ES61		Dummy CFD/ARD	N	SO1GBIII10	N250GB5.4KS	NSM8XS	5 in 1-Build in	3rd WiFi 1x2 BGN	BT 2.1	6CELL2.2	65W	US International (KB.I170A.056)	US and Continental

Test Compatible Components

This computer's compatibility is tested and verified by Acer's internal testing department. All of its system functions are tested under compatible Windows® operating system for each model.

Refer to the following lists for components, adapter cards, and peripherals which have passed these tests. Regarding configuration, combination and test procedures, please refer to the Compatibility Test Report released by the Acer Mobile System Testing Department.

Hardware Device Tests

Item	Device name	Vendor
I/O peripherals		
Access Point	Air Station Wireless NFINITI [ModeNum:WZR-G144N], 802.11n/g/b	Buffalo
	Buffalo Air Station NFINITI [ModeNum:WZR2-G300N], 802.11n/g/b	Buffalo
Bluetooth Access Point	Bluetooth Access Point [ModeNum:BT300]	X Bridge
Bluetooth Devices	Bluetooth Stereo Headset [ModeNum:HT820]	Motorola
	Bluetooth mouse [ModeNum:097855020512]	Logitech
	Motorola Bluetooth Wireless Headset H300	Motorola
	Sony Ericsson Stereo Bluetooth Headset HBH-DS970	Sony
External LCD	P243W 24" LCD Monitor	Acer
	P244W 24" LCD Monitor	Acer
	SP2208WFP 22" LCD Monitor	Dell
	UltraSharp 3008WFP 30-inch LCD Monitor	Dell
	2407FPW 24-inch LCD Monitor	Dell
	UltraSharp E2408WFP 24-inch widescreen HDMI Monitor	Dell
Earphone / Microphone	Hawk Stereo Headset 933	Hawk
Projector	3300MP Projector	Dell
SIM Card	FarEasTone 3G SIM Card	FarEasTone
	Chunghwa Telecom 3G SIM Card	Chunghwa Telecom
TV	W37G (HDMI)	Westenhouse
	TC-37MPK (VGA/HDMI)	Panasonic
USB 3G Card	Huawei mobile connect E220 USB Modem 3G (E220: HSDPA/UMTS/EDGE/GPRS/GSM)	Huawei
USB Camera	Canon Digital IXUS 860 IS Digital Compact Camera (8.0 Megapixel CCD sensor/DIGIC III with Face Detection AF/AE/FE/ 28mm wide-angle lens with optical Image Stabilizer, Media storage:SD,SDHC,MMC,MMCplus, built-in SD32MB)	Canon
USB Flash Drive	A-Data PD16 Vista 16GB	A-Data
	Apacer AH421 8GB	Apacer
	Transcend JetFlash USB2.0 Flash Drive V10 16GB Memory Key	Transcend
	Transcend JetFlash USB2.0 Flash Drive V85 8GB Memory Key	Transcend
USB HDD		
USB Hub and Others	Huawei mobile connect E220 USB Modem 3G (E220: HSDPA/UMTS/EDGE/GPRS/GSM)	Huawei
	PowerSync USB2.0 4-Port mini HUB(HU151W White)	PowerSync
	Techworks 4-Port USB2.0 Mini HUB(OW4PTUSBHB)	Techworks
USB Keyboard / Mouse	First Wheel Mouse	Logitech
	Internet Navigator Keyboard	Logitech
	Dell L30U 0N242F USB Keyboard	Dell
USB ODD	DVD+R/RW (USB 2.0)	Plextor
USB Printer	HP Deskjet F4280 All-in-One:Printer/ Scanner/Copier, 1200x2400dpi)	HP
USB Speaker / Joystick	iFun USB Speaker(JS1200UA)	JS
	Dell USB Speaker	Dell
USB Storage Drive	6-in-1 Flash Card Reader/Writer	PQI

Item	Device name	Vendor
Wireless Printer	Photosmart C309 (CC35A) All-in-One Printer (4x6 photos/CD/DVD/Quick Forms)/Scanner/Copier/Fax Port: USB2.0/Ethernet/PictBridge/802.11g/BT	HP
	Photosmart C4580 All-in-One Printer (4x6 photos) /Scanner/Copier Port:USB2.0/802.11g.b/Memory Card	HP
Memory Card		
Memory Stick	High speed 1GB Memory stick Pro Duo	Lexar
	MS PRO Dou 2GB High Speed	SONY
	MS PRO 2GB Memory Card	SONY
	SanDisk Meomry Stick Micro (M2) 8GB Card	SanDisk
Multimedia Card	RS-MMC 128MB Memory Card	Sandisk
	RS-MMC Mobile 256MB Memory Card	PQI
	Transcend MMC plus 4GB Card	Transcend
	Turbo 200X 2GB MMC Card	A-DATA
SD Card	4GB SD PRO Memory Card	RiDATA
	SanDisk multi-use SD Class2 Memory Card 2GB	SanDisk
	SD card 2GB (150x Hi-Speed)	Apacer
	SanDisk microSDHC 4GB Card with Adapter	SanDisk
	Kingston SDHC SD4 32GB Card	Kingston
XD Card	OLYMPUS XD-Picture Card M+ 2GB Speed Card	OLYMPUS
	FUJIFLM XD-Picture Card TypeM 2GB	FUJIFLM

Online Support Information

This section describes online technical support services available to help you repair your Acer Systems.

If you are a distributor, dealer, ASP or TPM, please refer your technical queries to your local Acer branch office. Acer Branch Offices and Regional Business Units may access our website. However some information sources will require a user i.d. and password. These can be obtained directly from Acer CSD Taiwan.

Acer's Website offers you convenient and valuable support resources whenever you need them.

In the Technical Information section you can download information on all of Acer's Notebook, Desktop and Server models including:

- Service guides for all models
- User's manuals
- Training materials
- Bios updates
- Software utilities
- Spare parts lists
- TABs (Technical Announcement Bulletin)

For these purposes, we have included an Acrobat File to facilitate the problem-free downloading of our technical material.

Also contained on this website are:

- Detailed information on Acer's International Traveller's Warranty (ITW)
- Returned material authorization procedures
- An overview of all the support services we offer, accompanied by a list of telephone, fax and email contacts for all your technical queries.

We are always looking for ways to optimize and improve our services, so if you have any suggestions or comments, please do not hesitate to communicate these to us.

A

AFLASH Utility 34
antennas
 removing 88
Audio 19

B

back cover
 removing 42
battery pack
 removing 40
BIOS 15
 vendor 15
 Version 15
BIOS Recovery 107
BIOS Recovery Boot Block 108
BIOS Recovery by Crisis Disk 108
 steps 108
BIOS Recovery Hotkey 108
BIOS Utility 23–34
 Navigating 24
 System Security 33
brightness
 hotkeys 6
button/indicator
 Bluetooth 9
 Wireless LAN 9
buttons
 easy-launch 9

C

caps lock
 on indicator 5
Clearing BIOS Password
 steps 107
Clearing Password 107
computer
 on indicator 5, 6
CPU
 removing 51
CPU Fan True Value Table 15
Crisis Disk
 creating 108
Crisis Recovery Disk 34

D

DIMM module
 removing 46

display
 hotkeys 6

E

Euro 11
External CD-ROM Drive Check 90
External Module Disassembly
 Flowchart 39

F

Flash Utility 34
front view 7
FRU (Field Replaceable Unit) List 113

H

Hard disk 17
HDD 17
HDD1 module
 removing 43
Hibernation mode
 hotkey 6
Hot Keys 10
hotkeys 6
HW Gap position 107

I

Indicator
 HDD 9
indicator
 battery 9
 power-on 9
Indicator/button
 power 9
Indicators 9
Intermittent Problems 104

K

Key
 Special 11
key
 Backup 9
 US dollar 11
Keyboard 10, 20
 removing 53
keyboard
 hotkeys 6
Keyboard or Auxiliary Input Device Check 90

L

- LCD bezel
 - removing 80
- LCD Brackets
 - removing 84
- LCD Module Disassembly
 - Flowchart 79
- LCD with the brackets
 - removing 81
- left speaker
 - removing 66
- left view 7
- Locations
 - connectors 105

M

- Main Screw List 38
- Main Unit Disassembly
 - Flowchart 48
- media access
 - on indicator 5
- Memory Check 91
- menu
 - Boot 32
 - Exit 33
 - Information 25
 - Security 28
- middle cover
 - removing 53
- Model Definition 125

N

- notebook tour 5
- num lock
 - on indicator 5

O

- Online Support Information 151

P

- password
 - changing 30
 - removing 30
 - setting 29
- Power Adapter Check 91
- Power System Check 91
 - Battery Pack 92
- Power-On Self-Test (POST) Error Message 92
- Processor 15

S

- Screw List 38
- speakers

- hotkey 6
- System 4
 - Block Diagram 4
- System Check Procedures 90
- System Memory 15
- System Utilities 13, 23
- System utilities
 - Acer GridVista 13

T

- Test Compatible Components 147
- touchpad and button boards
 - removing 61
- Touchpad Check 92
- Troubleshooting 89

U

- Undetermined Problems 104
- utility
 - BIOS 23–34

V

- view
 - bottom 8
 - front 7
 - left 7
 - rear 7
 - right 8
- view front 5

W

- Windows 2000 Environment Test 148