

**Aspire 5738DG/5738DZG Series**  
**Aspire 5542G/5542/5242 Series**  
**Aspire 5738G/5738ZG/5738Z/5738/5338 Series**  
**Aspire 5536/5536G/5236 Series**  
**Service Guide**

Service guide files and updates are available on the ACER/CSD web; for more information, please refer to <http://csd.acer.com.tw>

PRINTED IN TAIWAN

---

# Revision History

Please refer to the table below for the updates made on Aspire 5738DG/5738DZG, Aspire 5542G/5542/5242, Aspire 5738G/5738ZG/5738Z/5738/5338 and Aspire 5536/5536G/5236 Series service guide.

Date	Chapter	Updates

---

## Copyright

Copyright © 2009 by Acer Incorporated. All rights reserved. No part of this publication may be reproduced, transmitted, transcribed, stored in a retrieval system, or translated into any language or computer language, in any form or by any means, electronic, mechanical, magnetic, optical, chemical, manual or otherwise, without the prior written permission of Acer Incorporated.

## Disclaimer

The information in this guide is subject to change without notice.

Acer Incorporated makes no representations or warranties, either expressed or implied, with respect to the contents hereof and specifically disclaims any warranties of merchantability or fitness for any particular purpose. Any Acer Incorporated software described in this manual is sold or licensed "as is". Should the programs prove defective following their purchase, the buyer (and not Acer Incorporated, its distributor, or its dealer) assumes the entire cost of all necessary servicing, repair, and any incidental or consequential damages resulting from any defect in the software.

Acer is a registered trademark of Acer Corporation.

Intel is a registered trademark of Intel Corporation.

Pentium and Pentium II/III are trademarks of Intel Corporation.

Other brand and product names are trademarks and/or registered trademarks of their respective holders.

---

## Conventions

The following conventions are used in this manual:

<b>SCREEN MESSAGES</b>	Denotes actual messages that appear on screen.
<b>NOTE</b>	Gives bits and pieces of additional information related to the current topic.
<b>WARNING</b>	Alerts you to any damage that might result from doing or not doing specific actions.
<b>CAUTION</b>	Gives precautionary measures to avoid possible hardware or software problems.
<b>IMPORTANT</b>	Reminds you to do specific actions relevant to the accomplishment of procedures.

---

## Preface

Before using this information and the product it supports, please read the following general information.

1. This Service Guide provides you with all technical information relating to the BASIC CONFIGURATION decided for Acer's "global" product offering. To better fit local market requirements and enhance product competitiveness, your regional office MAY have decided to extend the functionality of a machine (e.g. add-on card, modem, or extra memory capability). These LOCALIZED FEATURES will NOT be covered in this generic service guide. In such cases, please contact your regional offices or the responsible personnel/channel to provide you with further technical details.
2. Please note WHEN ORDERING FRU PARTS, that you should check the most up-to-date information available on your regional web or channel. If, for whatever reason, a part number change is made, it will not be noted in the printed Service Guide. For ACER-AUTHORIZED SERVICE PROVIDERS, your Acer office may have a DIFFERENT part number code to those given in the FRU list of this printed Service Guide. You MUST use the list provided by your regional Acer office to order FRU parts for repair and service of customer machines.



<b>System Specifications</b>	<b>1</b>
Features	1
Dimension and weight	3
System Block Diagram	4
Your Acer Notebook tour	7
Right View	10
Indicators	12
Easy-Launch Buttons	12
Touchpad basics (with two-click buttons)	12
Using the Keyboard	13
Lock Keys and embedded numeric keypad	13
Windows Keys	14
Hot Keys	15
Special Key (only for certain models)	16
Using the System Utilities	17
Acer GridVista (dual-display compatible)	17
Hardware Specifications and Configurations	19
 <b>System Utilities</b>	 <b>27</b>
BIOS Setup Utility	27
Navigating the BIOS Utility	28
Information	29
Main	31
Security	33
Boot	37
Exit	38
BIOS Flash Utility	39
Remove HDD Password	40
 <b>Machine Disassembly and Replacement</b>	 <b>41</b>
Disassembly Requirements	41
General Information	42
Pre-disassembly Instructions	42
Disassembly Process	42
External Module Disassembly Process	43
External Modules Disassembly Flowchart	43
Removing the Battery Pack	44
Removing the SD Dummy Card	45
Removing the DIMM Module	46
Removing the Back Cover	47
Removing the Hard Disk Drive Module	48
Removing the WLAN Modules	51
Removing the Optical Drive Module	53
Main Unit Disassembly Process	55
Main Unit Disassembly Flowchart	55
Removing the Middle Cover	56
Removing the Keyboard	58
Removing the LCD Module	59
Separating the Upper Case from the Lower Case	62
Removing the Fingerprint and Touchpad Boards	66
Removing the Left Speaker Module	69
Removing the USB Board Module	70
Removing the Modem Module	72
Removing the Bluetooth Module	73

# Table of Contents

Removing the Right Speaker Module .....	75
Removing the Main Board .....	77
Removing the Heatsink Module .....	79
Removing the CPU .....	81
LCD Module Disassembly Process .....	83
LCD Module Disassembly Flowchart .....	83
Removing the LCD Bezel .....	84
Removing the Inverter Board (Aspire 5738DG/5738DZG Series only) .....	86
Removing the LCD panel with the Brackets .....	88
Removing the LCD Brackets .....	89
Removing the FPC Cable .....	90
Removing the Antennas .....	92
Removing the Web Camera .....	94
<b>Troubleshooting</b> .....	<b>95</b>
System Check Procedures .....	96
External Diskette Drive Check .....	96
External CD-ROM Drive Check .....	96
Keyboard or Auxiliary Input Device Check .....	96
Memory Check .....	97
Power System Check .....	97
Touchpad Check .....	98
Power-On Self-Test (POST) Error Message .....	98
Index of Error Messages .....	99
Phoenix BIOS Beep Codes .....	102
Index of Symptom-to-FRU Error Message .....	107
Intermittent Problems .....	111
Undetermined Problems .....	112
Main Board .....	113
<b>Connector Locations</b> .....	<b>113</b>
Clearing Password Check and BIOS Recovery .....	115
Clearing Password Check .....	115
BIOS Recovery by Crisis Disk .....	117
<b>FRU (Field Replaceable Unit) List</b> .....	<b>121</b>
Exploded Diagram .....	122
FRU List .....	123
<b>Model Definition and Configuration</b> .....	<b>214</b>
Aspire 5738G/5738ZG/5738Z/5738/5338 Series .....	215
Aspire 5536/5536G/5236 Series .....	235
Aspire 5738DG/5738DZG Series .....	249
Aspire 5542G/5542/5242 Series .....	263
<b>Test Compatible Components</b> .....	<b>291</b>
Microsoft® Windows® Environment Test .....	292
<b>Online Support Information</b> .....	<b>295</b>
<b>Index</b> .....	<b>297</b>



# System Specifications

---

## Features

Below is a brief summary of the computer's many features:

### Platform

For Aspire 5738DG/5738DZG and Aspire 5738G/5738ZG/5738Z/5738/5338 Series

- Intel® Centrino® 2 processor technology, featuring:
  - Intel® Core™ 2 Duo processor
  - Mobile Intel® PM45/GM45 Express Chipset\*
  - Intel® Wireless WiFi Link 5100/5300\*
  - Intel® Wireless WiFi Link 5150/5350\*
  - Unex HB95
- Intel® Pentium® mobile processor\*
- Intel® Celeron® mobile processor\*
- Mobile Intel® GM45/GL40 Express Chipset\*
- Acer InviLink™ Nplify™ 802.11b/g/Draft-N\*
- Acer InviLink™ 802.11b/g\*

For Aspire 5542G/5542/5242 and Aspire 5536/5536G/5236 Series

AMD Better By Design program, featuring:

- AMD Turion™ X2 dual-core processor\*
- AMD Athlon™ 64 X2 dual-core processor\*
- Mobile AMD Sempron™ processor\*
- AMD M780G Chipset
- Acer InviLink™ Nplify™ 802.11b/g/Draft-N\*
- Acer InviLink™ 802.11b/g\*

### System memory

For Aspire 5738DG/5738DZG and Aspire 5738G/5738ZG/5738Z/5738/5338 Series

- Dual-channel SDRAM support
- Up to 2 GB of DDR2 667/800 MHz memory, upgradeable to 4 GB using two soDIMM modules
- Up to 2 GB of DDR3 800/1066 MHz memory, upgradeable to 4 GB using two soDIMM modules\*
- Up to 4 GB of DDR3 1066 MHz memory, upgradeable to 8 GB using two soDIMM modules\*

For Aspire 5542G/5542/5242 and Aspire 5536/5536G/5236 Series

- Dual-channel SDRAM support
- Up to 2 GB of DDR2, upgradeable to 4 GB using two soDIMM modules\*
- Up to 4 GB of DDR2, upgradeable to 8 GB using two soDIMM modules\*

---

## Display and graphics

- 16:9 aspect ratio
- 15.6" HD 1366 x 768
- VGA Controller
  - For Aspire 5738G/5738ZG Series:
    - Mobile Intel® GL40 Express Chipset\*
    - Mobile Intel® GM45 Express Chipset\*
    - NVIDIA® GeForce® G105M\*
  - For Aspire 5738DG/5738DZG Series, Aspire 5542G and Aspire 5536G:
    - ATI Radeon™ HD 3200 Graphics\*
    - AATI Mobility Radeon™ HD 4570\*
- Screen resolution support
  - 1366\*768
  - 1280\*768
  - 1280\*720
  - 1024\*768
  - 800\*600

## Storage subsystem

- 2.5" hard disk drive
- Optical drive options:
  - Blu-ray Disc™/DVD-Super Multi double-layer drive\*
  - DVD-Super Multi double-layer drive\*
- 5-in-1 card reader

## Special keys and controls

- 103-/104-/107-key keyboard
- Touchpad pointing device

## Audio

- Dolby®-optimized surround sound system with two built-in stereo speakers
- True 5.1-channel surround sound output
- High-definition audio support
- S/PDIF (Sony/Philips Digital Interface) support for digital speakers
- MS-Sound compatible
- Built-in microphone

## Communication

- Acer Video Conference, featuring:
  - Integrated Acer Crystal Eye webcam\*
  - Optional Acer Xpress VoIP phone\*
- Wi-Fi/WiMAX: Intel® Wireless WiFi Link 5150/5350\* (For Aspire 5738G/5738ZG/5738Z/5738/5338 Series only)
- WWAN: UMTS/HSPA at 850/1900/2100 MHz and quad-band GSM/GPRS/EDGE (850/900/1800/1900 MHz)\* (For Aspire 5738G/5738ZG/5738Z/5738/5338 Series only)

- 
- WLAN:
    - Intel® Wireless WiFi Link 5100/5300\* (For Aspire 5738G/5738ZG/5738Z/5738/5338 and Aspire 5738DG only)
    - Acer InviLink™ Nplify™ 802.11b/g/Draft-N\*
    - Acer InviLink™ 802.11b/g\*
  - WPAN: Bluetooth® 2.0+Enhanced Data Rate (EDR)\*
  - LAN: Gigabit Ethernet; Wake-on-LAN ready
  - Modem: 56K ITU V.92; Wake-on-Ring ready

## I/O Ports

- Acer Bio-Protection fingerprint reader\*
- 5-in-1 card reader (SD/MMC/MS/MS PRO/xD)
- USB 2.0 port
- HDMI™ port with HDCP support
- External display (VGA) port
- Headphones/speaker/line-out jack with S/PDIF support
- Microphone-in jack
- Line-in jack
- Ethernet (RJ-45) port
- Modem (RJ-11) port
- DC-in jack for AC adapter

## Environment

- Temperature:
  - Operating: 5 °C to 35 °C
  - Non-operating: -20 °C to 65 °C
- Humidity (non-condensing):
  - Operating: 20% to 80%
  - Non-operating: 20% to 80%

## Dimension and weight

- Dimension: 383.82\* 250\* 37.74 mm
- Weight: <3.1 kg

**NOTES:** 1. "\*" means only for certain models".

2. The specifications listed above are for reference only. The exact configuration of your PC depends on the model purchased.

# System Block Diagram

For Aspire 5738DG/5738DZG and Aspire 5738G/5738ZG/5738Z/5738/5338 Series:

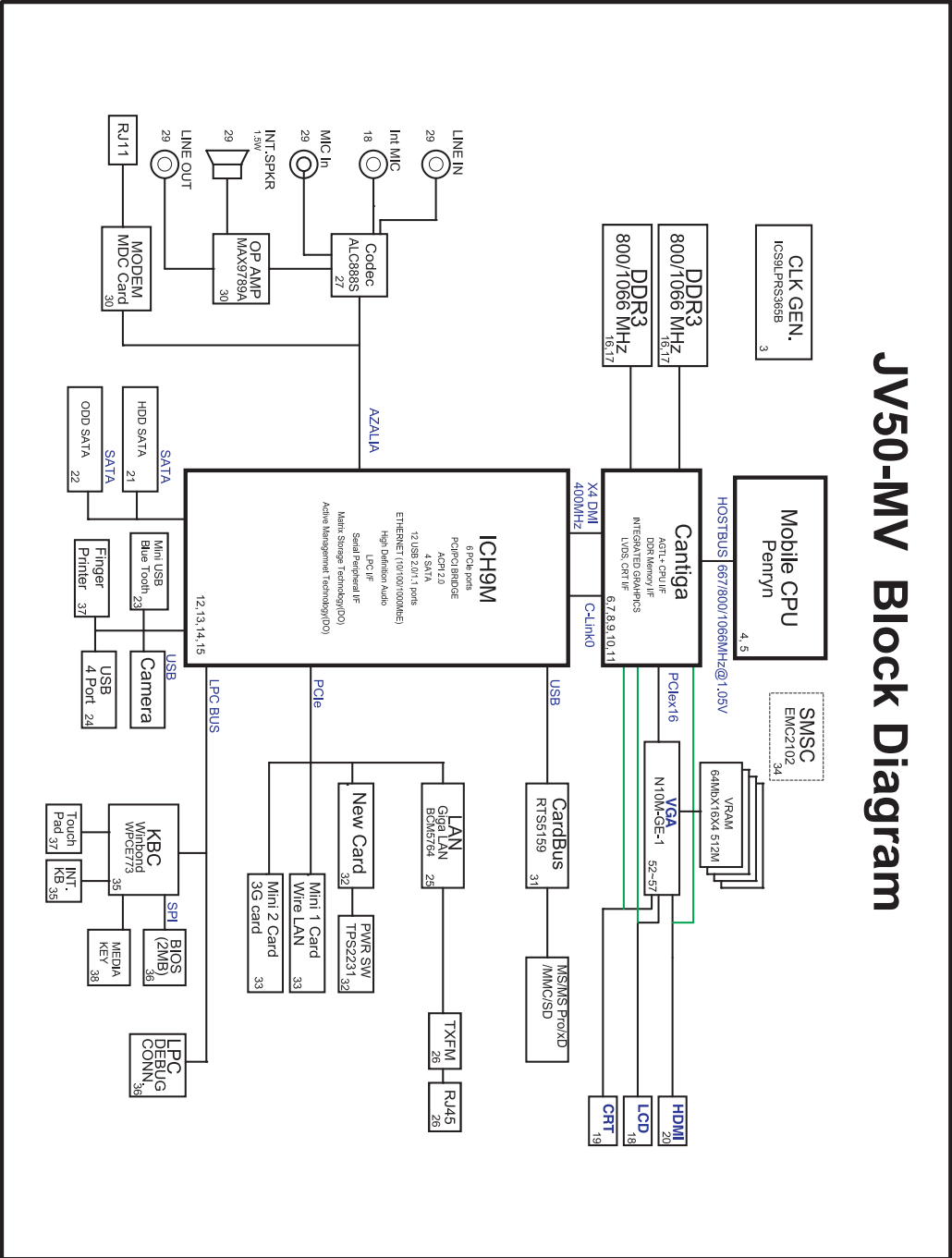

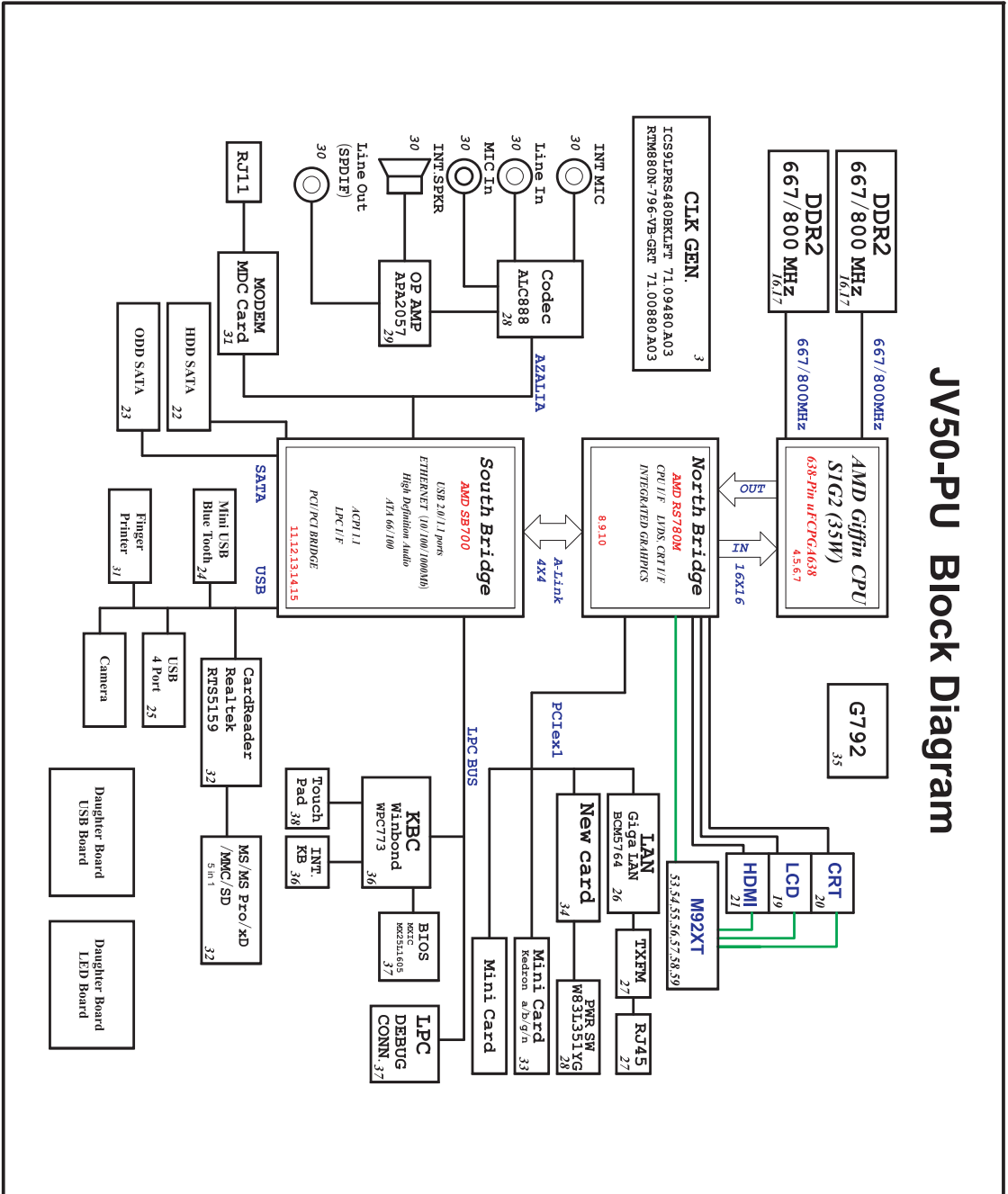

# JV50-TR Block Diagram

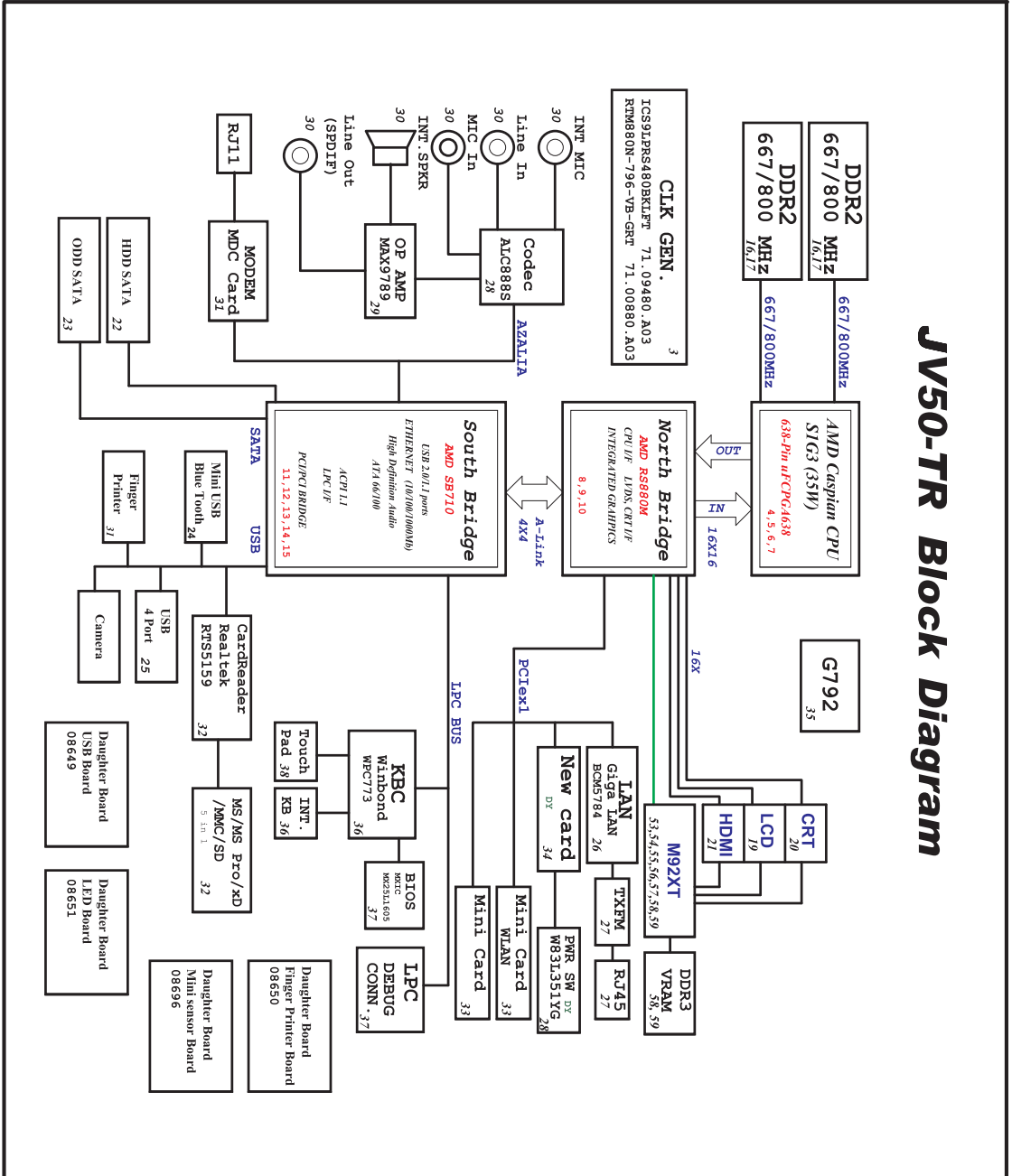







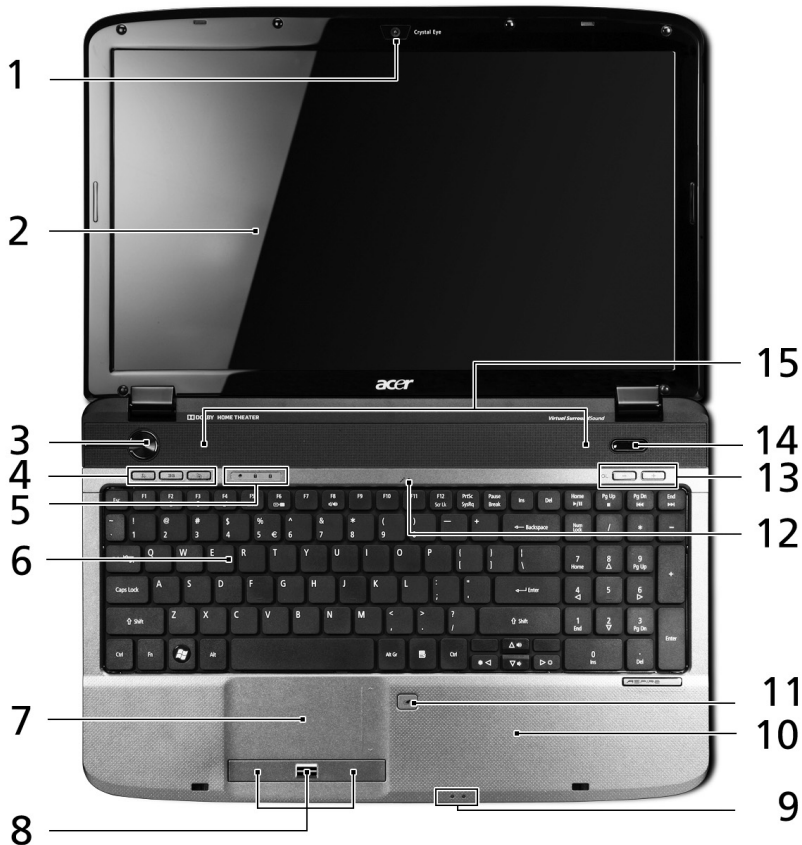





# Your Acer Notebook tour

After knowing your computer features, let us show you around your new computer.

## Front View



	Icon	Item	Description
1		Acer Crystal Eye webcam	Web camera for video communication.
2		Display screen	Also called Liquid-Crystal Display (LCD), displays computer output (Configuration may vary by models).
3		Power button	Turns the computer on and off.
4		Wireless LAN communication button/indicator	Enables/disables the wireless LAN function. Indicates the status of wireless LAN communication.
		Bluetooth communication button/indicator	Enables/disables the Bluetooth function. Indicates the status of Bluetooth communication. (only for certain models)
	3G	3G WWAN communication button/indicator	Enables/disables the 3G WWAN function. Indicates the status of 3G WWAN communication. (only for certain models)
		Backup key	Launches Acer Backup Management for three-step data backup.

	Icon	Item	Description
5		HDD	Indicates when the hard disk drive is active.
		Num Lock	Lights up when Num Lock is activated.
		Caps Lock	Lights up when Caps Lock is activated.
6		Keyboard	For entering data into your computer.
7		Touchpad	Touch-sensitive pointing device which functions like a computer mouse.
8		Click buttons (left, center* and right)	The left and right buttons function like the left and right mouse buttons. *The center button serves as Acer Bio-Protection fingerprint reader supporting Acer FingerNav 4-way control function (only for certain models).
9		Power <sup>1</sup>	Indicates the computer's power status.
		Battery <sup>1</sup>	Indicates the computer's battery status. <b>1. Charging:</b> The light shows amber when the battery is charging. <b>2. Fully charged:</b> The light shows blue when in AC mode.
10		Palmrest	Comfortable support area for your hands when you use the computer.
11		Touchpad toggle	Turns the internal touchpad on and off.
12		Microphone	Internal microphone for sound recording.
13	+/-	Volume Up/Volume Down	Increase system volume/decrease system volume.
14		Acer PowerSmart key	Puts your computer into power-saving mode.
15		Speakers	Left and right speakers deliver stereo audio output.

## Closed Front View

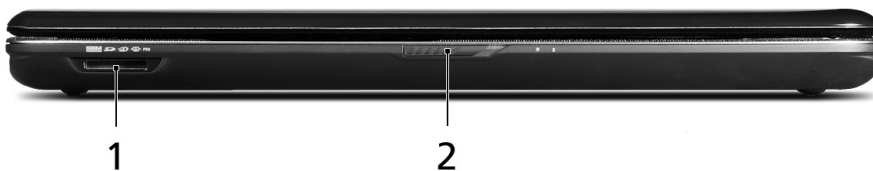





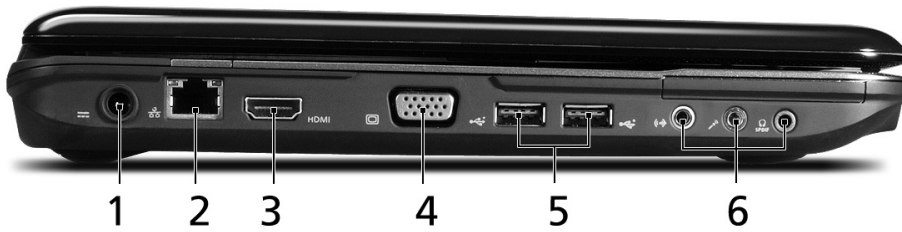

	Icon	Item	Description
1		5-in-1 card reader	Accepts Secure Digital (SD), MultiMediaCard (MMC), Memory Stick (MS), Memory Stick PRO (MS PRO), xD-Picture Card (xD). <b>Note:</b> Push to remove/install the card. Only one card can operate at any given time.
2		Latch	Locks and releases the lid.







## Left View

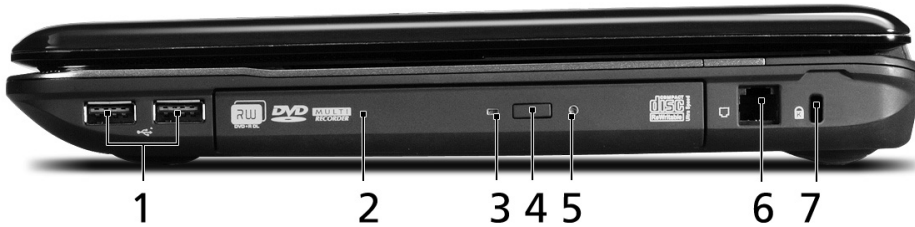

#	Icon	Item	Description
1		DC-in jack	Connects to an AC adapter.
2		Ethernet (RJ-45) port	Connects to an Ethernet 10/100/1000-based network.
3	HDMI	HDMI port	Supports high definition digital video connections.
4		External display (VGA) port	Connects to a display device (e.g., external monitor, LCD projector).
5		USB 2.0 port	Connect to USB 2.0 devices (e.g., USB mouse, USB camera).
6		Line-in jack	Accepts audio line-in devices (e.g., audio CD player, stereo walkman, mp3 player)
		Microphone-in jack	Accepts inputs from external microphones.
		Headphones/speaker/line-out jack with S/PDIF support	Connects to audio line-out devices (e.g., speakers, headphones).

## Right View



	Icon	Item	Description
1		USB 2.0 port	Connects to USB 2.0 devices (e.g., USB mouse, USB camera).
2		Optical drive	Internal optical drive; accepts CDs or DVDs.
3		Optical disk access indicator	Lights up when the optical drive is active.
4		Optical drive eject button	Ejects the optical disk from the drive.
5		Emergency eject hole	Ejects the optical drive tray when the computer is turned off. <b>Note:</b> Insert a paper clip to the emergency eject hole to eject the optical drive tray when the computer is off.
6		Modem (RJ-11) port	Connects to a phone line.
7		Kensington lock slot	Connects to a Kensington-compatible computer security lock.





## Rear View

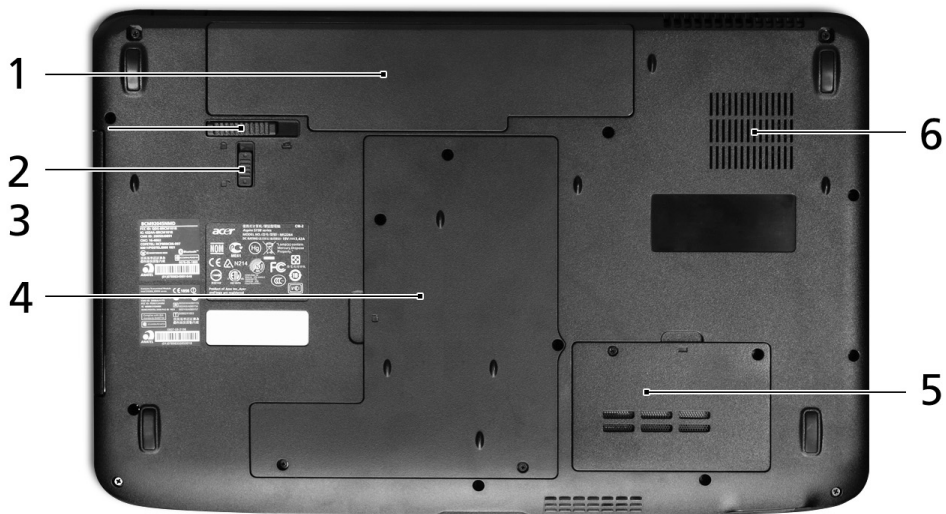

#	Item	Description
1	Ventilation slots	Enable the computer to stay cool, even after prolonged use.



## Bottom View



	Icon	Item	Description
1		Battery bay	Houses the computer's battery pack.
2		Battery release latch	Releases the battery for removal.
3		Battery lock	Locks the battery in position.
4		Hard disk bay	Houses the computer's hard disk (secured with screws).
5		Memory compartment	Houses the computer's main memory.
6		Ventilation slots and cooling fan	Enable the computer to stay cool, even after prolonged use. <b>Note:</b> Do not cover or obstruct the opening of the fan.

# Indicators

The computer has several easy-to-read status indicators. The front panel indicators are visible even when the computer cover is closed.



Icon	Function	Description
	Power	Indicates the computer's power status.
	Battery	Indicates the computer's battery status.

**NOTE:** 1. **Charging:** The light shows amber when the battery is charging. 2. **Fully charged:** The light shows green when in AC mode.

# Easy-Launch Buttons

Located above the keyboard are application buttons. These buttons are called easy-launch buttons. They are: WLAN, Internet, email, Bluetooth, Arcade and Acer Empowering Technology.

The mail and Web browser buttons are pre-set to email and Internet programs, but can be reset by users. To set the Web browser, mail and programmable buttons, run the Acer Launch Manager. You can access the Launch Manager by clicking on Start, All Programs, and then Launch Manager to start the application.

Icon	Function	Description
	Wireless LAN communication button/indicator	Enables/disables the wireless LAN function. Indicates the status of wireless LAN communication.
	Bluetooth communication button/indicator	Enables/disables the Bluetooth function. Indicates the status of Bluetooth communication. (only for certain models)
3G	3G WWAN communication button/indicator	Enables/disables the 3G WWAN function. Indicates the status of 3G WWAN communication. (only for certain models)
	Backup key	Launches Acer Backup Management for three-step data backup.
VOL+	Volume up	Increases the sound volume.
VOL-	Volume down	Decreases the sound volume.

# Touchpad basics (with two-click buttons)

The following items show you how to use the touchpad with two-click buttons.

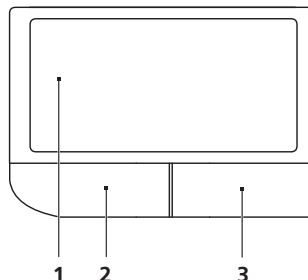

- Move your finger across the touchpad (1) to move the cursor.
- Press the left (2) and right (3) buttons located beneath the touchpad to perform selection and execution functions. These two buttons are similar to the left and right buttons on a mouse. Tapping on the touchpad is the same as clicking the left button.

Function	Left button (2)	Right button (3)	Main touchpad (1)
Execute	Quickly click twice.		Tap twice (at the same speed as double-clicking a mouse button).
Select	Click once.		Tap once.
Drag	Click and hold, then use finger on the touchpad to drag the cursor.		Tap twice (at the same speed as double-clicking a mouse button); rest your finger on the touchpad on the second tap and drag the cursor.
Access context menu		Click once.	

**NOTE:** Illustrations are for reference only. The exact configuration of your PC depends on the model purchased.

**NOTE:** When using the touchpad, keep it — and your fingers — dry and clean. The touchpad is sensitive to finger movement; hence, the lighter the touch, the better the response. Tapping harder will not increase the touchpad's responsiveness.

**NOTE:** By default, vertical and horizontal scrolling is enabled on your touchpad. It can be disabled under Mouse settings in Windows Control Panel.

## Using the Keyboard

The keyboard has full-sized keys and an embedded numeric keypad, separate cursor, lock, Windows, function and special keys.

## Lock Keys and embedded numeric keypad

The keyboard has three lock keys which you can toggle on and off.

Lock key	Description
Caps Lock	When Caps Lock is on, all alphabetic characters typed are in uppercase.
Num Lock <Fn> + <F11>	When Num Lock is on, the embedded keypad is in numeric mode. The keys function as a calculator (complete with the arithmetic operators +, -, *, and /). Use this mode when you need to do a lot of numeric data entry. A better solution would be to connect an external keypad. <b>NOTE:</b> <Fn> + <F11> works only for certain models.
Scroll Lock <Fn> + <F12>	When Scroll Lock is on, the screen moves one line up or down when you press the up or down arrow keys respectively. Scroll Lock does not work with some applications.



















The embedded numeric keypad functions like a desktop numeric keypad. It is indicated by small characters located on the upper right corner of the key caps. To simplify the keyboard legend, cursor-control key symbols are not printed on the keys.

Desired access	Num Lock on	Num Lock off
Number keys on embedded keypad	Type numbers in a normal manner.	
Cursor-control keys on embedded keypad	Hold <Shift> while using cursor-control keys.	Hold <Fn> while using cursor-control keys.

Desired access	Num Lock on	Num Lock off
Main keyboard keys	Hold <Fn> while typing letters on embedded keypad.	Type the letters in a normal manner.

## Windows Keys

The keyboard has two keys that perform Windows-specific functions.









Key	Description
 Windows key	<p>Pressed alone, this key has the same effect as clicking on the Windows Start button; it launches the Start menu.</p> <p>It can also be used with other keys to provide a variety of functions:</p> <ul style="list-style-type: none"> <li>&lt;  &gt;: Open or close the Start menu</li> <li>&lt;  &gt; + &lt;D&gt;: Display the desktop</li> <li>&lt;  &gt; + &lt;E&gt;: Open Windows Explore</li> <li>&lt;  &gt; + &lt;F&gt;: Search for a file or folder</li> <li>&lt;  &gt; + &lt;G&gt;: Cycle through Sidebar gadgets</li> <li>&lt;  &gt; + &lt;L&gt;: Lock your computer (if you are connected to a network domain), or switch users (if you're not connected to a network domain)</li> <li>&lt;  &gt; + &lt;M&gt;: Minimizes all windows</li> <li>&lt;  &gt; + &lt;R&gt;: Open the Run dialog box</li> <li>&lt;  &gt; + &lt;T&gt;: Cycle through programs on the taskbar</li> <li>&lt;  &gt; + &lt;U&gt;: Open Ease of Access Center</li> <li>&lt;  &gt; + &lt;X&gt;: Open Windows Mobility Center</li> <li>&lt;  &gt; + &lt;BREAK&gt;: Display the System Properties dialog box</li> <li>&lt;  &gt; + &lt;SHIFT+M&gt;: Restore minimized windows to the desktop</li> <li>&lt;  &gt; + &lt;TAB&gt;: Cycle through programs on the taskbar by using Windows Flip 3-D</li> <li>&lt;  &gt; + &lt;SPACEBAR&gt;: Bring all gadgets to the front and select Windows Sidebar</li> <li>&lt;CTRL&gt; + &lt;  &gt; + &lt;F&gt;: Search for computers (if you are on a network)</li> <li>&lt;CTRL&gt; + &lt;  &gt; + &lt;TAB&gt;: Use the arrow keys to cycle through programs on the taskbar by using Windows Flip 3-D</li> </ul> <p><b>Note:</b> Depending on your edition of Windows Vista, some shortcuts may not function as described.</p>
 Application key	<p>This key has the same effect as clicking the right mouse button; it opens the application's context menu.</p>

---

## Hot Keys

The computer employs hotkeys or key combinations to access most of the computer's controls like screen brightness, volume output and the BIOS utility.

To activate hot keys, press and hold the <Fn> key before pressing the other key in the hotkey combination.

Hotkey	Icon	Function	Description
<Fn> + <F2>		Acer eSettings	Launches Acer eSettings in Acer Empowering Technology.
<Fn> + <F3>		Bluetooth	Enables/disables Bluetooth function.
<Fn> + <F4>		Sleep	Puts the computer in Sleep mode.
<Fn> + <F5>		Display toggle	Switches display output between the display screen, external monitor (if connected) and both.
<Fn> + <F6>		Screen blank	Turns the display screen backlight off to save power. Press any key to return.
<Fn> + <F8>		Speaker toggle	Turns the speakers on and off.
<Fn> + <D>		Brightness up	Increases the screen brightness.
<Fn> + <C>		Brightness down	Decreases the screen brightness.
<Fn> + <A>		Volume up	Increases the sound volume (only for certain models).
<Fn> + <V>		Volume down	Decreases the sound volume (only for certain models).

---

## Special Key (only for certain models)

You can locate the Euro symbol and the US dollar sign at the upper-center and/or bottom-right of your keyboard.

### The Euro symbol

1. Open a text editor or word processor.
2. Either press < € > on the keyboard, or hold <Alt Gr> and then press the <5> key at the upper-center of the keyboard.

**NOTE:** Some fonts and software do not support the Euro symbol. Please refer to [www.microsoft.com/typography/faq/faq12.htm](http://www.microsoft.com/typography/faq/faq12.htm) for more information.

### The US dollar sign

1. Open a text editor or word processor.
2. Either press < \$ > at the bottom-right of the keyboard, or hold <Shift> and then press the <4> key at the upper-center of the keyboard.

**NOTE:** This function varies according to the language settings.



---

# Using the System Utilities

## Acer GridVista (dual-display compatible)

**NOTE:** This feature is only available on certain models.

To enable the dual monitor feature of the notebook, first ensure that the second monitor is connected, then select **Start, Control Panel, Display** and click on **Settings**. Select the secondary monitor (**2**) icon in the display box and then click the check box **Extend my windows desktop onto this monitor**. Finally, click **Apply** to confirm the new settings and click **OK** to complete the process.

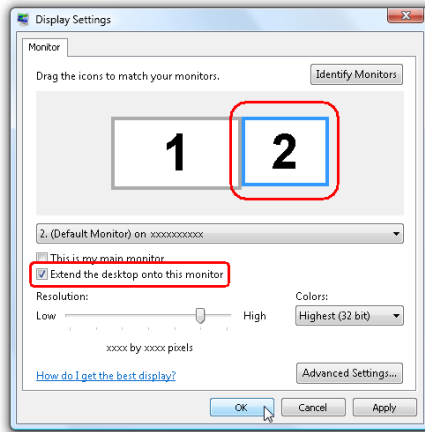

Acer GridVista is a handy utility that offers four pre-defined display settings so you can view multiple windows on the same screen. To access this function, please go to **Start>All Programs** and click on **Acer GridVista**. You may choose any one of the four display settings indicated below:

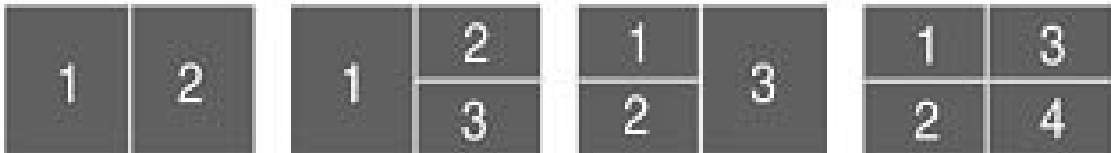

Double (vertical), Triple (primary at left), Triple (primary at right), or Quad Acer GridVista is dual-display compatible, allowing two displays to be partitioned independently.

Acer GridVista is dual-display compatible, allowing two displays to be partitioned independently.

AcerGridVista is simple to set up:

1. Run Acer GridVista and select your preferred screen configuration for each display from the task bar.
2. Drag and drop each window into the appropriate grid.
3. Enjoy the convenience of a well-organized desktop.

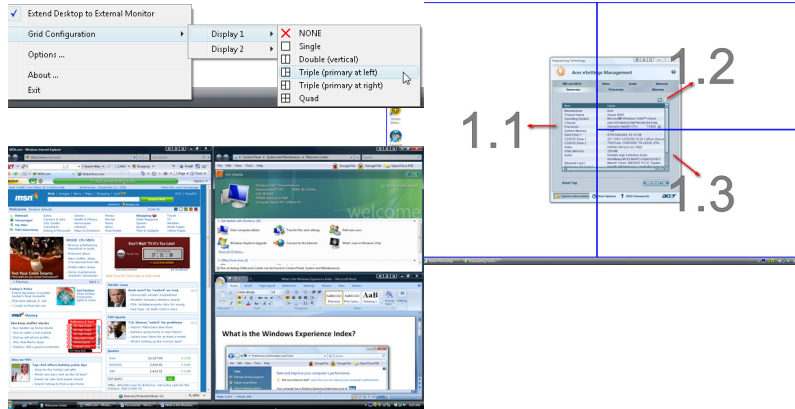

**NOTE:** Please ensure that the resolution setting of the second monitor is set to the manufacturer's recommended value.

# Hardware Specifications and Configurations

## Processor

Item	Specification
CPU type	Aspire 5738DG: Intel® Core™2 Duo Mobile Processor P7350 (2.0 GHz) Aspire 5738DZG: Intel® Core™2 Duo Mobile Processor T4300 (2.1 GHz) Aspire 5738G: Intel® Core™2 Duo Mobile Processor P7450 (2.13GHz), T6400 (2.0 GHz) and T6600 (2.2GHz) Aspire 5738ZG: Intel® Core™2 Duo Mobile Processor T4200 (2.0 GHz) Aspire 5738Z: Intel® Core™2 Duo Mobile Processor T4200 (2.0 GHz) Aspire 5738: Intel® Core™2 Duo Mobile Processor T6400 (2.0 GHz) Aspire 5338: Intel CMT1600 Aspire 5542G: AMD Turion M620 2.5G 2M and AMD Turion M600 2.4G 2M Aspire 5542: AMD Turion II M520 2.3G Aspire 5242: Mobile AMD Sempron M100 2.0G Aspire 5536/5536G/5236 Series: AMD Athlon™ 64 X2 dual-core mobile processor 2.1GHz AMD Turion™ X2 Ultra dual-core mobile processor 2.2GHz/2.1GHz Mobile AMD Sempron™ processor 2.1GHz
Core logic	Aspire 5738DG/5738DZG and Aspire 5738G/5738ZG/5738Z/5738/5338: Mobile Intel® GM45/GL40/PM45 Express Chipset Aspire 5536/5536G/5236: AMD M780G Chipset
CPU package	Aspire 5738DG/5738DZG and Aspire 5738G/5738ZG/5738Z/5738/5338: 478-pin micro-FCPGA Aspire 5536/5536G/5236: Socket S1
CPU core voltage	Aspire 5738DG/5738DZG and Aspire 5738G/5738ZG/5738Z/5738/5338: 1.0375V to 1.3V Aspire 5536/5536G/5236: 1.35V to 1.5V

## CPU Fan True Value Table

DTS(degree C)	Fan Speed (rpm)	Acoustic Level (dBA)
45-50	0-3000	29
55-66	0-3300	33
68-74	3300-3800	38
78-83	3800-4100	40
86-91	4100-4800	40

Throttling 50%: On= 99° C; OFF=93° C

OS shut down at 105° C; H/W shot down at 110° .C

## BIOS

Item	Specification
BIOS vendor	Phoenix
BIOS Version	1.04c

## System Memory

Item	Specification
Memory controller	Built-in
Memory size	0MB (no on-board memory)
DIMM socket number	2 sockets
Supports memory size per socket	2048MB
Supports maximum memory size	4G for 64bit OS (with two 2GB SODIMM)
Supports DIMM type	DDR 3 synchronous DRAM DDR 2 synchronous DRAM
Supports DIMM Speed	800/1066 MHz; 667/800 MHz
Supports DIMM voltage	1.5V
Supports DIMM package	240-pin soDIMM
Memory module combinations	You can install memory modules in any combinations as long as they match the above specifications.

## Memory Combinations

Slot 1	Slot 2	Total Memory
0MB	512MB	512MB
0MB	1024MB	1024MB
0MB	2048MB	2048MB
512MB	512MB	1024MB
512MB	1024MB	1536MB
512MB	2048MB	2560MB
1024MB	0MB	1024MB
1024MB	512MB	1536MB
1024MB	1024MB	2048MB
1024MB	2048MB	3072MB
2048MB	0MB	2048MB
2048MB	512MB	2560MB
2048MB	1024MB	3072MB
2048MB	2048MB	4096MB

**NOTE:** Above table lists some system memory configurations. You may combine DIMMs with various capacities to form other combinations. On above table, the configuration of slot 1 and slot 2 could be reversed.

## LAN Module

Item	Specification
LAN Chipset	Broadcom BCM5784
Supports LAN protocol	10/100/1000 Mbps
LAN connector type	RJ45
LAN connector location	Left side
Features	Integrated 10/100 BASE-T transceiver Wake on LAN support compliant with ACPI 2.0 PCI v2.2

### Bluetooth Interface

Item	Specification
Chipset	Foxconn Bluetooth FOX_BRM_2.0 F/W 300; Foxconn Bluetooth BRM 2046 BT2.1
Data throughput	723 bps (full speed data rate)
Protocol	Bluetooth 1.1 (Upgradeable to Bluetooth 1.2 when SIG specification is ratified).
Interface	USB 1.1
Connector type	USB

### Wireless Module 802.11b/g/n

Item	Specification
Chipset	Aspire 5738DG/5738DZG Series and Aspire 5738G/5738ZG/5738Z/5738/5338 Series: Unex HB95; LAN Intel WLAN 512AN_MMWG Shirley Peak 5100 MM#895373; Foxconn Wireless LAN Atheros AR5B91 1x2 BGN/WLAN 802.11ABGN SHIRLEYPEAK1*2; Lan Intel WLAN 533AN_MMWG Shirley Peak MM#895362 Aspire 5536/5536G/5236 Series: Foxconn Wireless LAN Atheros AR5B91 1x2 BGN; QMI Wireless LAN Atheros AR5B91 1x2 BGN; Foxconn FOX_ATH_XB63; Foxconn Atheros XB63 minicard b/g Aspire 5542G/5542/5242 Series: Foxconn Wireless LAN Atheros HB95 1x1 BG (HM); QMI Wireless LAN Atheros HB93 1x2 BGN (HM)
Data throughput	11~54 Mbps, up to 270 Mbps for Draft-N
Protocol	802.11b+g, Draft-N
Interface	PCI bus (mini PCI socket for wireless module)

### Hard Disk Drive Interface

Item				
Vendor & Model Name	HDD WD 2.5" 5400rpm 160GB WD1600BEVT-22ZCT0 SEAGATE 2.5" 5400rpm 160GB ST9160314AS	HGST 2.5" 5400rpm 250GB HTS545025B9A300 SEAGATE 2.5" 5400rpm 250GB	HGST 2.5" 5400rpm 320GB HTS545032B9A300 HDD WD 2.5" 5400rpm 320GB WD3200BEVT-22ZCT0 22ZCT0	HGST 2.5" 5400rpm 500GB HTS545050B9A300
Capacity (MB)	160000	250000	320000	500000
Bytes per sector	512	512	512	512
Data heads	3/4	2	3	4
Drive Format				
Disks	2	1	2	2
Spindle speed (RPM)	5400 RPM	5400 RPM	5400 RPM	5400 RPM
Performance Specifications				

## Hard Disk Drive Interface

Item				
Buffer size	8MB	8MB	8MB	8MB
Interface	SATA	SATA	SATA	SATA
Max. media transfer rate (disk-buffer, Mbytes/s)	540	875 (Max. 3.0 Gbit/s Buffer-host data transfer)	875 (Max. 3.0 Gbit/s Buffer-host data transfer)	875 (Max. 3.0 Gbit/s Buffer-host data transfer)
DC Power Requirements				
Voltage tolerance	5V(DC) +/- 5%	5V(DC) +/- 5%	5V(DC) +/- 5%	5V(DC) +/- 5%

## Optical Disc Drive

Item	Specification
Vendor & model name	HLDS Super-Multi Drive DL 8X GT30N LF SONY Super-Multi Drive DL 8X AD-7590S LF SONY Super-Multi Drive DL 8X AD-7580S LF TOSHIBA Super-Multi Drive DL 8X TS-L633B LF TOSHIBA Super-Multi Drive DL 8X TS-L633C
Performance Specification	With CD Diskette                      With DVD Diskette
Transfer rate (KB/sec)	Sustained: Max 3.6Mbytes/sec                      Sustained: Max 10.08Mbytes/sec
Buffer Memory	2MB
Interface	SATA
Applicable disc format	Applicable disc format CD: CD-DA, CD-ROM, CD-ROM XA, Photo CD (multi-session), Video CD, Cd-Extra (CD+), CD-text DVD: DVD-VIDEO, DVD-ROM, DVD-R (3.9GB, 4.7GB) DVD-R DL, DVD-RW, DVD-RAM, DVD+R, DVD+R DL, DVD+RW CD: CD-DA (Red Book) - Standard Audio CD & CD-TEXT CD-ROM (Yellow Book Mode1 & 2) - Standard Data CD-ROM XA (Mode2 Form1 & 2) - Photo CD, Multi-Session CD-I (Green Book, Mode2 Form1 & 2, Ready, Bridge) CD-Extra/ CD-Plus (Blue Book) - Audio & Text/Video Video-CD (White Book) - MPEG1 Video CD-R (Orange Book Part) CD-RW & HSRW (Orange Book Part Volume1 & Volume 2) Super Audio CD (SACD) Hybrid type US & US+ RW DVD: DVD-ROM (Book 1.02), DVD-Dual DVD-Video (Book 1.1) DVD-R (Book 1.0, 3.9G) DVD-R (Book 2.0, 4.7G) - General & Authoring DVD+R (Version 1.0) DVD+RW DVD-RW (Non CPRM & CPRM) DVD <sup>DR</sup> R Dual

### Optical Disc Drive

Item	Specification
Loading mechanism	Load: Manual Release: (a) Electrical Release (Release Button) (b) Release by ATAPI command (c) Emergency Release
Power Requirement	
Input Voltage	5 V +/- 5% (Operating)

### Blu-Ray Disc Drive

Item	Specification		
Vendor & model name	HLDS BD COMBO DRIVE TRAY DL 4X CT10 LF PANASONIC BD COMBO 12.7mm Tray DL 4X UJ-130A		
Performance Specification	With CD Disc	With DVD Disc	With Blu-ray Disc
Transfer rate (KB/sec)	Sustained: Max 3.6Mbytes/sec	Sustained: Max 10.08Mbytes/sec	Sustained: Max 11 Mbytes/sec
Buffer Memory	2MB		4.5 MB
Interface	SATA		
Applicable disc format	<p>Applicable disc format</p> <p>CD: CD-DA, CD-ROM, CD-ROM XA, Photo CD (multi-session), Video CD, Cd-Extra (CD+), CD-text</p> <p>DVD: DVD-VIDEO, DVD-ROM, DVD-R (3.9GB, 4.7GB) DVD-R DL, DVD-RW, DVD-RAM, DVD+R, DVD+R DL, DVD+RW</p> <p>CD:</p> <p>CD-DA (Red Book) - Standard Audio CD &amp; CD-TEXT</p> <p>CD-ROM (Yellow Book Mode1 &amp; 2) - Standard Data</p> <p>CD-ROM XA (Mode2 Form1 &amp; 2) - Photo CD, Multi-Session</p> <p>CD-I (Green Book, Mode2 Form1 &amp; 2, Ready, Bridge)</p> <p>CD-Extra/ CD-Plus (Blue Book) - Audio &amp; Text/Video</p> <p>Video-CD (White Book) - MPEG1 Video</p> <p>CD-R (Orange Book Part)</p> <p>CD-RW &amp; HSRW (Orange Book Part Volume1 &amp; Volume 2</p> <p>Super Audio CD (SACD) Hybrid type</p> <p>US &amp; US+ RW</p> <p>DVD:</p> <p>DVD-ROM (Book 1.02), DVD-Dual</p> <p>DVD-Video (Book 1.1)</p> <p>DVD-R (Book 1.0, 3.9G)</p> <p>DVD-R (Book 2.0, 4.7G) - General &amp; Authoring</p> <p>DVD+R (Version 1.0)</p> <p>DVD+RW</p> <p>DVD-RW (Non CPRM &amp; CPRM)</p> <p>DVD+/-R Dual</p> <p>Blu-Ray:</p> <p>BD-R, BD-R DL, BD-RE, BD-RE DL</p>		

## Blu-Ray Disc Drive

Item	Specification
Loading mechanism	Load: Manual Release: (a) Electrical Release (Release Button) (b) Release by ATAPI command (c) Emergency Release
Power Requirement	
Input Voltage	5 V +/- 5% (Operating)

## Audio Interface

Item	Specification
Audio Controller	Realtek ALC888S-VC
Audio onboard or optional	Built-in
Mono or Stereo	Stereo
Resolution	18 bit stereo full duplex
Compatibility	HD audio Interface; S/PDIF output for PCM or AC-3 content
Sampling rate	1Hz resolution VSR (Variable Sampling Rate)
Internal microphone	Yes
Internal speaker / Quantity	Yes/2.1 (2W speakers)

## Video

Item	Specification
Chipset	Aspire 5738G/5738ZG: <ul style="list-style-type: none"> <li>• Mobile Intel® GL40 Express Chipset*</li> <li>• Mobile Intel® GM45 Express Chipset*</li> <li>• NVIDIA® GeForce® G105M*</li> </ul> Aspire 5738DG/5738DZG, Aspire 5542G and Aspire 5536G : <ul style="list-style-type: none"> <li>• ATI Radeon™ HD 3200 Graphics*</li> <li>• ATI Mobility Radeon™ HD 4570*</li> </ul>
Memory size	1 GB DDR3

## USB

Item	Specification
Chipset	Aspire 5738DG/5738DZG/5738G/5738ZG/5738Z/5738/5338 Series: ICH-9M Aspire 5536/5536G/5236 Series: AMD SB700/
USB Compliancy Level	2.0
OHCI	USB 1.1 and USB 2.0 Host controller
Number of USB ports	4
Location	Two on the right side/two on the left side
Serial port function control	Enable/Disable by BIOS Setup



### System Board Major Chips

Item	Controller
Core logic	Aspire 5738DG/5738DZG/5738G/5738ZG/5738Z/5738/ 5338 Series: Mobile Intel® GM45/GL40/PM45 Aspire 5536/5536G/5236 Series: ATI RS780MN
USB 2.0	Aspire 5738DG/5738DZG/5738G/5738ZG/5738Z/5738/ 5338 Series: Intel ICH-9M Aspire 5536/5536G/5236 Series: AMD SB700
Super I/O controller	N/A
MODEM	Aspire 5738DG/5738DZG/5738G/5738ZG/5738Z/5738/ 5338 Series: Foxconn Delphi-AM5 V2H 1.5_3.3v AUS T60M951 Aspire 5536/5536G/5236 Series: Lite-On Conexant -Unizion 1.5_3.3v AUS RD02-D330
Bluetooth	Foxconn Bluetooth FOX_BRM_2.0 F/W 300; Foxconn Bluetooth BRM 2046 BT.1
Wireless 802.11 b/g/n	Aspire 5738DG/5738DZG/5738G/5738ZG/5738Z/5738/ 5338 Series: Unex HB95; Lan Intel WLAN 533AN_MMWG Shirley Peak/Foxconn Wireless LAN Wireless LAN Ralink RT2700E 1x2 BGN Aspire 5536/5536G/5236: Foxconn Wireless LAN Atheros AR5B91 1x2 BGN/Foxconn Wireless LAN Wireless LAN Ralink RT2700E 1x2 BGN
6 in 1 Card Reader	Realtek USB Card Reader
Audio Codec	Realtek ALC888s Azalia

### Keyboard

Item	Specification
Keyboard controller	NS PC97541V
Total number of keypads	105/106-key keyboard
Windows logo key	Yes
Internal & external keyboard work simultaneously	Plug USB keyboard to the USB port directly: Yes

### Battery

Item	Specification
Vendor	Sony/Sanyo/Simplo
Battery Type	Li-ion
Pack capacity	8-cell 4800mAh/6-cell 4400mAh
Number of battery cell	8/6
Package configuration	4 cells in series, 2 series in parallel/ 3 cells in series, 2 series in parallel/

### LCD 15.6" inches

Item	Specification
Vendor & model name	AUO /CMO/LPL/Samsung/ARISAWA
Screen Diagonal (mm)	15.6 inches
Display resolution (pixels)	15.6" Full HD 1920 x 1080/15.6" HD+ 1680 x 945
Pixel Pitch	0.204 x 0.204
Pixel Arrangement	R.G.B. Vertical Stripe
Display Mode	Normally White
Typical White Luminance (NIT) also called Brightness	220
Luminance Uniformity	1.25 max.
Contrast Ratio	400 typical
Response Time msec	8
Nominal Input Voltage VDD	+3.3V
Viewing Angle (degree) Horizontal: Right/Left Vertical: Upper/Lower	45/45 15/35
Temperature Range(° C) Operating Storage (shipping)	0 to +50 -40 to +60

### AC Adaptor

Item	Specification
Input	100-240V~ 1.5A, 50-60Hz/
Output	90W 19V 4.74A; 65W 19V

### System Power Management

ACPI mode	Power Management
Mech. Off (G3)	All devices in the system are turned off completely.
Soft Off (G2/S5)	OS initiated shutdown. All devices in the system are turned off completely.
Working (G0/S0)	Individual devices such as the CPU and hard disc may be power managed in this state.
Suspend to RAM (S3)	CPU set power down VGA Suspend PCMCIA Suspend Audio Power Down Hard Disk Power Down CD-ROM Power Down Super I/O Low Power mode
Save to Disk (S4)	Also called Hibernation Mode. System saves all system states and data onto the disc prior to power off the whole system.

# System Utilities

## BIOS Setup Utility

The BIOS Setup Utility is a hardware configuration program built into your computer's BIOS (Basic Input/Output System).

Your computer is already properly configured and optimized, and you do not need to run this utility. However, if you encounter configuration problems, you may need to run Setup. Please also refer to Chapter 4 Troubleshooting when problem arises.

To activate the BIOS Utility, press **F2** during POST (when "Press <F2> to enter Setup" message is prompted on the bottom of screen).

Press **F2** to enter setup. The default parameter of F12 Boot Menu is set to "disabled". If you want to change boot device without entering BIOS Setup Utility, please set the parameter to "enabled".

Press <F12> during POST to enter multi-boot menu. In this menu, user can change boot device without entering BIOS SETUP Utility.

```

Phoenix SecureCore(tm) Setup Utility
-----
Information  Main  Security  Boot  Exit

CPU Type:           Intel (R) Core (TM)2 Duo CPU T6400 @ 2.00 GHz
CPU Speed:          2.00GHz
IDE0 Model Name:    XXXXXXXXXXXX-(XX)
IDE0 Serial Number: XXXXXXXX
ATAPI Model Name:   XXXXXXXXXXXX-XXX XX-XXXX-(XX)
System BIOS Version: VX.XX
VGA BIOS Version:   XX-XXX XXXXXX.XXX.XXX.XXX.XXXXXX
KBC Version:        XX.XX
Serial Number:      XXXXXXXXXXXXXXXXXXXXXXXXXX
Asset Tag Number:   None
Product Name:       Aspire 5738
Manufacturer Name:  Acer
UUID:              XXXxXxXX-xXxX-XXxx-xXXx-xXXxXXxXxxXX

F1 Help  ↑↓ Select Item  -/+ Change Values  F9 Setup Defaults
Esc Exit  ← Select Menu  Enter Select ► Sub-Menu  F10 Save and Exit

```

---

## Navigating the BIOS Utility

There are five menu options: Information, Main, Security, Boot, and Exit.

Follow these instructions:

- To choose a menu, use the left and right arrow keys.
- To choose an item, use the up and down arrow keys.
- To change the value of a parameter, press **F5** or **F6**.
- A plus sign (+) indicates the item has sub-items. Press **Enter** to expand this item.
- Press **Esc** while you are in any of the menu options to go to the Exit menu.
- In any menu, you can load default settings by pressing **F9**. You can also press **F10** to save any changes made and exit the BIOS Setup Utility.

**NOTE:** You can change the value of a parameter if it is enclosed in square brackets. Navigation keys for a particular menu are shown on the bottom of the screen. Help for parameters are found in the Item Specific Help part of the screen. Read this carefully when making changes to parameter values. **Please note that system information is subject to different models.**

# Information

The Information screen displays a summary of your computer hardware information.

Intel CPU:

The screenshot shows the Phoenix SecureCore(tm) Setup Utility interface. The title bar reads "Phoenix SecureCore(tm) Setup Utility". Below the title bar is a navigation menu with five options: "Information" (highlighted), "Main", "Security", "Boot", and "Exit". The main display area shows the following system information:

CPU Type:	Intel (R) Core (TM)2 Duo CPU T6400 @ 2.00 GHz
CPU Speed:	2.00GHz
IDE0 Model Name:	XXXXXXXXXX-(XX)
IDE0 Serial Number:	XXXXXXXX
ATAPI Model Name:	XXXXXXXXXX-XXX XX-XXXX-(XX)
System BIOS Version:	VX.XX
VGA BIOS Version:	XX-XXX XXXXXX.XXX.XXX.XXX.XXXXXX
KBC Version:	XX.XX
Serial Number:	XXXXXXXXXXXXXXXXXXXXXXXXXX
Asset Tag Number:	None
Product Name:	Aspire 5738
Manufacturer Name:	Acer
UUID:	XXXxXxXX-xXxX-XXxx-xXXx-xXXxXXxXxxXX

At the bottom of the screen is a legend for navigation keys:

F1 Help	↑↓ Select Item	-/+ Change Values	F9 Setup Defaults
Esc Exit	← Select Menu	Enter Select	▶ Sub-Menu F10 Save and Exit

AMD CPU:

The screenshot shows the Phoenix SecureCore(tm) Setup Utility interface. The title bar reads "Phoenix SecureCore(tm) Setup Utility". Below the title bar is a navigation menu with five options: "Information" (highlighted), "Main", "Security", "Boot", and "Exit". The main display area shows the following system information:

CPU Type:	AMD Turion (tm) X2 Dual-Core Mobile RM-74
CPU Speed:	2.20GHz
IDE0 Model Name:	XXXXXXXXXX-(XX)
IDE0 Serial Number:	XXXXXXXX
ATAPI Model Name:	XXXXXXXXXX-XXX XX-XXXX-(XX)
System BIOS Version:	VX.XX
VGA BIOS Version:	XX-XXX XXXXXX.XXX.XXX.XXX.XXXXXX
KBC Version:	XX.XX
Serial Number:	XXXXXXXXXXXXXXXXXXXXXXXXXX
Asset Tag Number:	None
Product Name:	Aspire 5536
Manufacturer Name:	Acer
UUID:	XXXxXxXX-xXxX-XXxx-xXXx-xXXxXXxXxxXX

At the bottom of the screen is a legend for navigation keys:

F1 Help	↑↓ Select Item	-/+ Change Values	F9 Setup Defaults
Esc Exit	← Select Menu	Enter Select	▶ Sub-Menu F10 Save and Exit

**NOTE:** The system information is subject to different models.

Parameter	Description
CPU Type	This field shows the CPU type and speed of the system.
CPU Speed	This field shows the speed of the CPU.
IDE0 Model Name	This field shows the model name of HDD installed on primary IDE master.
IDE0 Serial Number	This field displays the serial number of HDD installed on primary IDE master.
IDE1 Model Name	This field shows the model name of HDD installed on secondary IDE master.
IDE1 Serial Number	This field displays the serial number of HDD installed on secondary IDE master.
ATAPI Model Name	This field shows the model name of the Optical device installed in the system.
System BIOS Version	Displays system BIOS version.
VGA BIOS Version	This field displays the VGA firmware version of the system.
KBC Ver	This field shows the keyboard
Serial Number	This field displays the serial number of this unit.
Asset Tag Number	This field displays the asset tag number of the system.
Product Name	This field shows product name of the system.
Manufacturer Name	This field displays the manufacturer of this system.
UUID Number	Universally Unique Identifier (UUID) is an identifier standard used in software construction, standardized by the Open Software Foundation (OSF) as part of the Distributed Computing Environment (DCE).

# Main

The Main screen allows the user to set the system time and date as well as enable and disable boot option and recovery.

Intel CPU:

Phoenix SecureCore(tm) Setup Utility				
Information	Main	Security	Boot	Exit
System Time: [10:10:10] System Date: [03/05/2009]  System Memory: 632 KB Extended Memory: 4093 MB Video Memory: 512 MB  Quiet Boot: [Enabled] Network Boot: [Enabled] F12 Boot Menu: [Disabled] D2D Recovery: [Enabled] SATAMode [AHCI]				Item Specific Help  <Tab>, <Shift-Tab>, or <Enter> selects field.
F1 Help	↑↓ Select Item	-/+ Change Values	F9 Setup Defaults	
Esc Exit	←→ Select Menu	Enter Select	▶ Sub-Menu	F10 Save and Exit

AMD CPU:

Phoenix SecureCore(tm) Setup Utility				
Information	Main	Security	Boot	Exit
System Time: [10:10:10] System Date: [03/06/2009]  Total Memory: 4096 KB Video Memory: 512 MB  Quiet Boot: [Enabled] Network Boot: [Enabled] F12 Boot Menu: [Disabled] D2D Recovery: [Enabled] SATAMode [AHCI]				Item Specific Help  <Tab>, <Shift-Tab>, or <Enter> selects field.
F1 Help	↑↓ Select Item	-/+ Change Values	F9 Setup Defaults	
Esc Exit	←→ Select Menu	Enter Select	▶ Sub-Menu	F10 Save and Exit

**NOTE:** The screen above is for your reference only. Actual values may differ.

The table below describes the parameters in this screen. Settings in **boldface** are the default and suggested parameter settings.

Parameter	Description	Format/Option
System Time	Sets the system time. The hours are displayed with 24-hour format.	Format: HH:MM:SS (hour:minute:second) System Time
System Date	Sets the system date.	Format MM/DD/YYYY (month/day/year) System Date
System Memory	This field reports the memory size of the system. Memory size is fixed to 640MB	
Total Memory	This field reports the total memory size of the system.	
Extended Memory	This field reports the memory size of the extended memory in the system. Extended Memory size=Total memory size-1MB	
VGA Memory	Shows the VGA memory size.	
Quiet Boot	Determines if Customer Logo will be displayed or not; shows Summary Screen is disabled or enabled. Enabled: Customer Logo is displayed, and Summary Screen is disabled. Disabled: Customer Logo is not displayed, and Summary Screen is enabled.	Option: <b>Enabled</b> or Disabled
Network Boot	Enables, disables the system boot from LAN (remote server).	Option: <b>Enabled</b> or Disabled
F12 Boot Menu	Enables, disables Boot Menu during POST.	Option: <b>Disabled</b> or Enabled
D2D Recovery	Enables, disables D2D Recovery function. The function allows the user to create a hidden partition on hard disc drive to store operation system and restore the system to factory defaults.	Option: <b>Enabled</b> or Disabled
SATA Mode	Control the mode in which the SATA controller should operate.	Option: <b>AHCI</b> or IDE

**NOTE:** The sub-items under each device will not be shown if the device control is set to disable or auto. This is because the user is not allowed to control the settings in these cases.



# Security

The Security screen contains parameters that help safeguard and protect your computer from unauthorized use.

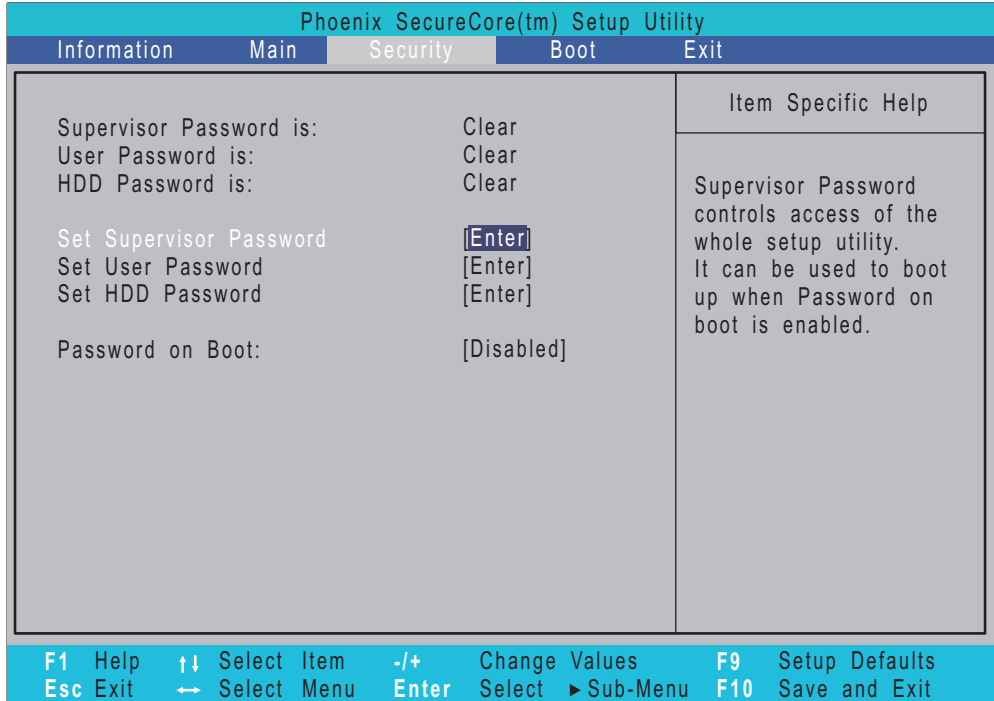

**NOTE:** Please refer to “Remove HDD/BIOS Password” section if you need to know how to remove HDD/BIOS Password.

The table below describes the parameters in this screen. Settings in **boldface** are the default and suggested parameter settings.

Parameter	Description	Option
Supervisor Password Is	Shows the setting of the Supervisor password	<b>Clear</b> or Set
User Password Is	Shows the setting of the user password.	<b>Clear</b> or Set
HDD Password Is	Shows the setting of the hard disk password.	<b>Clear</b> or Set
Set Supervisor Password	Press Enter to set the supervisor password. When set, this password protects the BIOS Setup Utility from unauthorized access. The user can not either enter the Setup menu nor change the value of parameters.	
Set User Password	Press Enter to set the user password. When user password is set, this password protects the BIOS Setup Utility from unauthorized access. The user can enter Setup menu only and does not have right to change the value of parameters.	
Set HDD Password	Enter HDD Password.	
Password on Boot	Defines whether a password is required or not while the events defined in this group happened. The following sub-options are all requires the Supervisor password for changes and should be grayed out if the user password was used to enter setup.	<b>Disabled</b> or Enabled

**NOTE:** When you are prompted to enter a password, you have three tries before the system halts. Don't forget your password. If you forget your password, you may have to return your notebook computer to your dealer to reset it.

## Setting a Password

Follow these steps as you set the user or the supervisor password:

1. Use the up/down keys to highlight the Set Supervisor Password parameter and press the Enter key. The Set Supervisor Password box appears:

Set Supervisor Password

Enter New Password [                    ]

Confirm New Password [                    ]

2. Type a password in the "Enter New Password" field. The password length can not exceeds 8 alphanumeric characters (A-Z, a-z, 0-9, not case sensitive). Retype the password in the "Confirm New Password" field.

**IMPORTANT:** Be very careful when typing your password because the characters do not appear on the screen.

3. Press Enter.  
After setting the password, the computer sets the User Password parameter to "Set".
4. If desired, you can opt to enable the Password on boot parameter.
5. When you are done, press the F10 key to save the changes and exit the BIOS Setup Utility.

---

## Removing a Password

Follow these steps:

1. Use the up/down keys to highlight the Set Supervisor Password parameter and press the Enter key. The Set Password box appears:

Set Supervisor Password		
Enter current password	[	]
Enter New Password	[	]
Confirm New Password	[	]

2. Type the current password in the Enter Current Password field and press Enter.
3. Press Enter twice **without** typing anything in the Enter New Password and Confirm New Password fields. The computer then sets the Supervisor Password parameter to "Clear".
4. When you have changed the settings, press F10 to save the changes and exit the BIOS Setup Utility.

## Changing a Password

1. Use the up/down keys to highlight the Set Supervisor Password parameter and press the Enter key. The Set Password box appears:

Set Supervisor Password		
Enter current password	[	]
Enter New Password	[	]
Confirm New Password	[	]

2. Type the current password in the Enter Current Password field and press Enter.
3. Type a password in the Enter New Password field. Retype the password in the Confirm New Password field.
4. Press e. After setting the password, the computer sets the User Password parameter to "Set".
5. If desired, you can enable the Password on boot parameter.
6. When you are done, press F10 to save the changes and exit the BIOS Setup Utility.

If the verification is OK, the screen will display as following.

Setup Notice	
Changes have been saved.	
[ continue]	

The password setting is complete after the user presses F10.

---

If the current password entered does not match the actual current password, the screen will show you the Setup Warning.

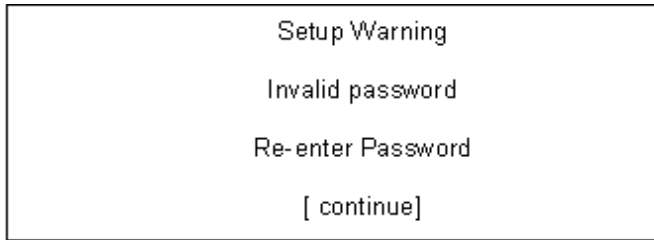

Setup Warning  
Invalid password  
Re-enter Password  
[ continue]

A rectangular dialog box with a black border containing four lines of centered text.

If the new password and confirm new password strings do not match, the screen will display the following message.

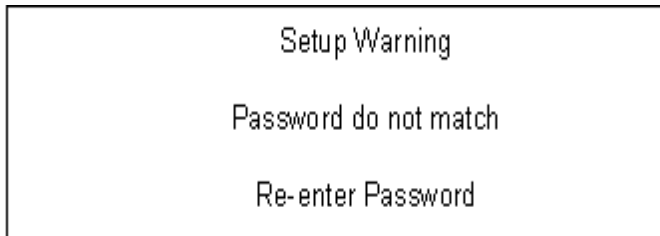

Setup Warning  
Password do not match  
Re-enter Password

A rectangular dialog box with a black border containing three lines of centered text.

# Boot

This menu allows the user to decide the order of boot devices to load the operating system. Bootable devices includes the diskette drive in module bay, the onboard hard disk drive and the CD-ROM in module bay.

Phoenix SecureCore(tm) Setup Utility				
Information	Main	Security	Boot	Exit
Boot priority order:  1: IDE0: XXXXXXXXXXXX-(XX) 2: CD/DVD: XXXXXXXXXXXX-XXXXX-(X) 3: Network Boot: XXXXXXXXXXXXXXXXXXXX 4: USB HDD: 5: USB FDD: 6: USB Key: 7: USB CD/DVD ROM:				Item Specific Help  Use <↑> or <↓> to select a device, then press <F6> to move it up the list, or <F5> to move it down the list. Press <Esc> to escape the menu.
F1 Help	↑↓ Select Item	-/+ Change Values	F9 Setup Defaults	
Esc Exit	←→ Select Menu	Enter Select	▶ Sub-Menu	F10 Save and Exit

# Exit

The Exit screen contains parameters that confirmed or discard the changes made to the parameters in the BIOS Setup Utility.

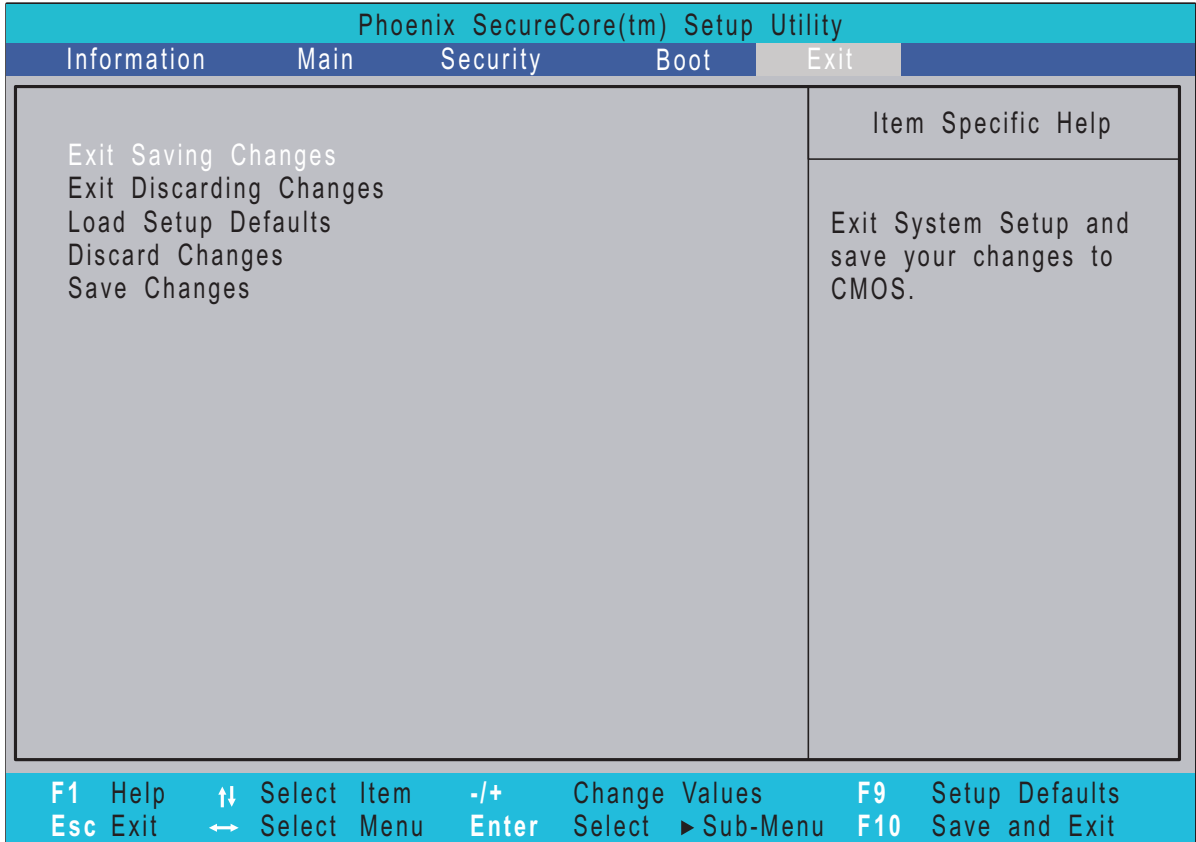

The table below describes the parameters in this screen.

Parameter	Description
Exit Saving Changes	Exit System Setup and save your changes to CMOS.
Exit Discarding Changes	Exit utility without saving setup data to CMOS.
Load Setup Default	Load default values for all SETUP item.
Discard Changes	Load previous values from CMOS for all SETUP items.
Save Changes	Save Setup Data to CMOS.

---

# BIOS Flash Utility

The BIOS flash memory update is required for the following conditions:

- New versions of system programs
- New features or options
- Restore a BIOS when it becomes corrupted.

Use the Flash utility to update the system BIOS flash ROM.

**NOTE:** If you do not have a crisis recovery disk at hand, then you should create a **Crisis Disk** (See “Creating the Crisis Disk in Windows” on page 117) before you use the Flash utility.

**NOTE:** Do not install memory-related drivers (XMS, EMS, DPMS) when you use the Flash.

**NOTE:** Please use the AC adaptor power supply when you run the Flash utility. If the battery pack does not contain enough power to finish BIOS flash, you may not boot the system because the BIOS is not completely loaded.

Follow the steps below to run the Flash utility:

1. Rename the BIOS file as “XXXXXXX.FD”
2. Copy the “XXXXXXX.FD” file to a bootable USB device containing the Crisis Disk.
3. Turn off the system power.
4. Insert the USB device containing the renamed BIOS file and Crisis Disk to any USB port.
5. Make sure the AC adapter is connected to a power outlet and plugged in to the system.
6. Power on the system from an off state (i.e. cold boot) while holding down the Fn + ESC key.
7. After POST, release Fn + ESC key. The system should boot from the USB device and perform crisis recovery action.

# Remove HDD Password

This section teaches you how to remove HDD password:

## Remove HDD Password:

- If you key in the wrong HDD password thrice, “HDD password error code” will appear on the screen. See the image below.

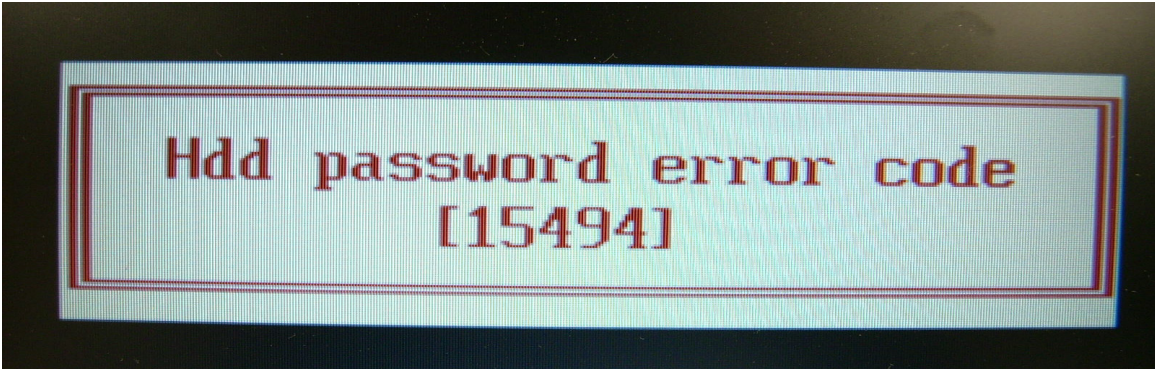

- If you need to solve HDD password locked problem, you can run HDD\_PW.EXE
  1. Key in “hdd\_pw 15494 0”
  2. Select “2”
  3. Choose one of the uppercase strings

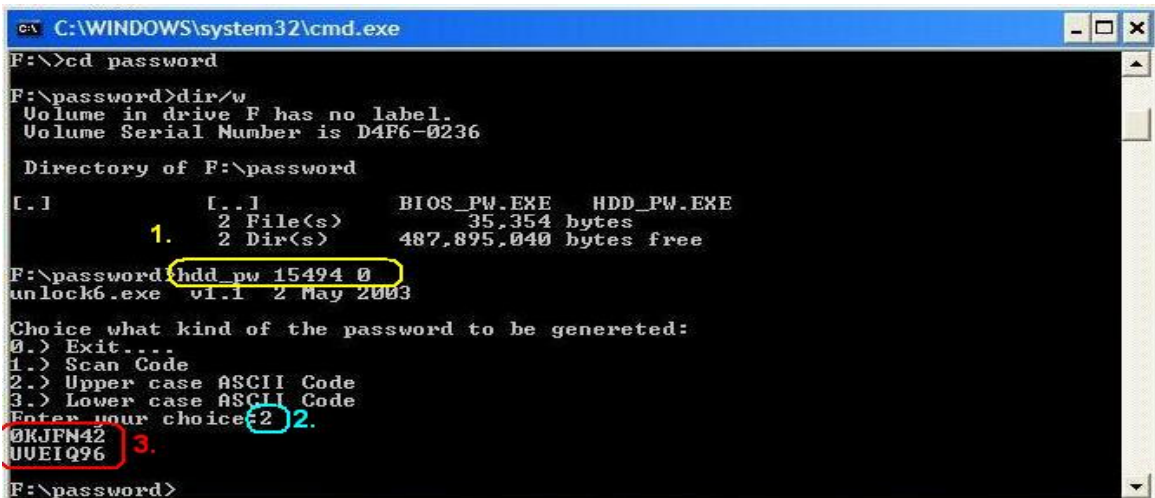

- Reboot the system and key in “0KJFN42” or “UVEIQ96” as your HDD user password.





# Machine Disassembly and Replacement

---

This chapter contains step-by-step procedures on how to disassemble the notebook computer for maintenance and troubleshooting.

## Disassembly Requirements

To disassemble the computer, you need the following tools:

- Wrist grounding strap and conductive mat for preventing electrostatic discharge
- Flat screwdriver
- Philips screwdriver
- Hex screwdriver
- Plastic flat screwdriver
- Plastic tweezers

**NOTE:** The screws for the different components vary in size. During the disassembly process, group the screws with the corresponding components to avoid mismatch when putting back the components.

---

# General Information

## Pre-disassembly Instructions

Before proceeding with the disassembly procedure, make sure that you do the following:

1. Turn off the power to the system and all peripherals.
2. Unplug the AC adapter and all power and signal cables from the system.



3. Place the system on a flat, stable surface.
4. Remove the battery pack.

## Disassembly Process

The disassembly process is divided into the following stages:

- External module disassembly
- Main unit disassembly
- LCD module disassembly

The flowcharts provided in the succeeding disassembly sections illustrate the entire disassembly sequence. Observe the order of the sequence to avoid damage to any of the hardware components. For example, if you want to remove the main board, you must first remove the keyboard, then disassemble the inside assembly frame in that order.

### Main Screw List

Item	Screw	Color	Part No.
A	M2.5 x L8	Black	86.00E34.738
B	M2.5 x L6	Black	86.00E12.536
C	M2 x L3	Silver	86.9A522.3R0
D	M3 x L4	Silver	86.9A554.4R0
E	M2 x L4	Black	86.00E13.524
F	M2 x L4	Silver	86.9A552.4R0
G	M2.5 x L10	Silver	86.1A553.100

# External Module Disassembly Process

## External Modules Disassembly Flowchart

The flowchart below gives you a graphic representation on the entire disassembly sequence and instructs you on the components that need to be removed during servicing. For example, if you want to remove the main board, you must first remove the keyboard, then disassemble the inside assembly frame in that order.

### EXTERNAL MODULE DISASSEMBLY

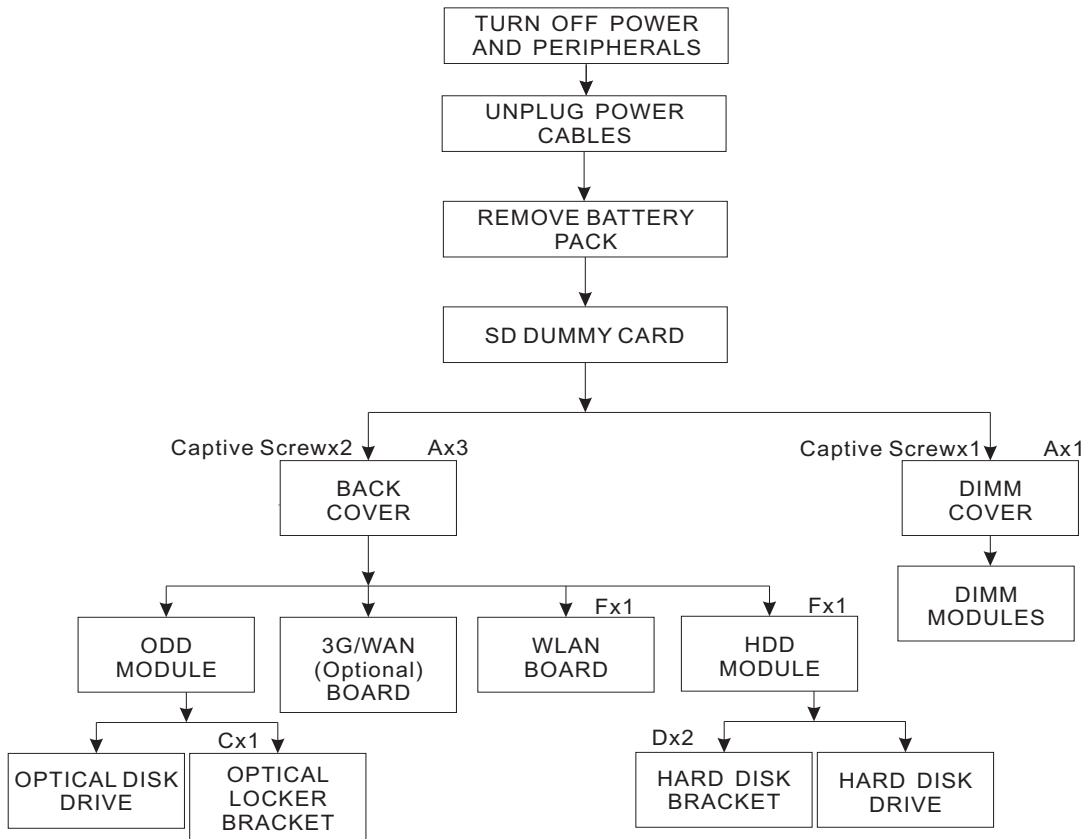

### Screw List

Item	Screw	Color	Part No.
A	M2.5 x L8	Black	86.00E34.738
D	M3 x L4	Silver	86.9A554.4R0
F	M2 x L4	Silver	86.9A552.4R0

---

## Removing the Battery Pack

1. Turn base unit over.
2. Slide the battery lock/unlock latch to the unlock position.



**Note:** Battery has been highlighted with the yellow circle as above image shows. Please detach the battery and follow the local regulations for disposal.

3. Slide the battery release latch to the release position to pop out the battery pack, then remove the battery pack from the main unit.



---

## Removing the SD Dummy Card

1. Push the SD dummy card all the way in to eject it.



2. Pull it out from the slot.



## Removing the DIMM Module

1. See “Removing the Battery Pack” on page 44.
2. Remove the one captive screw and one screw (A) securing the DIMM module cover.



Size (Quantity)	Color	Torque	Part No.
M2.5 x L8 (1)	Black	3 kgf-cm	86.00E34.738

3. Use a plastic screw driver to carefully pry open the DIMM module cover.



4. Push out the latches on both sides of the DIMM socket to release the DIMM.



5. Remove the DIMM module.

## Removing the Back Cover

1. See “Removing the Battery Pack” on page 44.
2. See “Removing the SD Dummy Card” on page 45.
3. See “Removing the DIMM Module” on page 46.
4. Remove the two captive screws and three screws (A) securing the back cover.



Size (Quantity)	Color	Torque	Part No.
M2.5 x L8 (3)	Black	3 kgf-cm	86.00E34.738

- 
5. Use a plastic screw driver to carefully pry open the back cover.



6. Remove the back cover from the lower case.

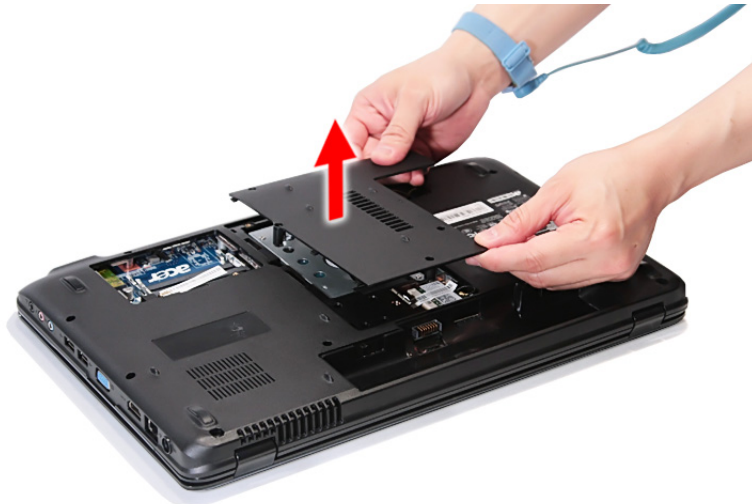

## Removing the Hard Disk Drive Module

1. See “Removing the Battery Pack” on page 44.
2. See “Removing the SD Dummy Card” on page 45.
3. See “Removing the DIMM Module” on page 46.
4. See “Removing the Back Cover” on page 47.



5. Remove the one screw (F) securing the hard disk drive module.



Size (Quantity)	Color	Torque	Part No.
M2 x L4 (1)	Silver	1.6 kgf-cm	86.9A552.4R0

6. Slide the hard disk drive module away from the connector.



7. Lift the hard disk drive module and remove it from the hard disk drive bay.



**NOTE:** To prevent damage to device, avoid pressing down on it or placing heavy objects on top of it.

8. Remove the two screws (D) securing the hard disk to the bracket and remove the hard disk from the bracket.

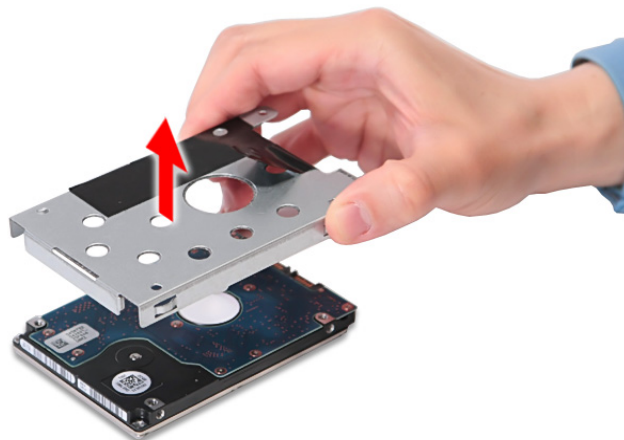

Size (Quantity)	Color	Torque	Part No.
M3 x L4 (2)	Silver	3.0 kgf-cm	86.9A554.4R0

## Removing the WLAN Modules

1. See “Removing the Battery Pack” on page 44.
2. See “Removing the SD Dummy Card” on page 45.
3. See “Removing the DIMM Module” on page 46.
4. See “Removing the Back Cover” on page 47.
5. See “Removing the Hard Disk Drive Module” on page 48.
6. Disconnect the black antenna cable from connector #1 and the white antenna cable from connector #2 on the short wireless board module.



7. Remove the one screw (F) securing the short wireless board module to the system.



Size (Quantity)	Color	Torque	Part No.
M2 x L4 (1)	Silver	1.6 kgf-cm	86.9A552.4R0

8. Detach the short wireless board module from the WLAN socket.



**NOTE:** When attaching the antenna back to the WLAN board, make sure the cable are arranged properly.

9. Disconnect the blue antenna cable from the auxiliary connector and disconnect the yellow antenna cable from the main connector on the WLAN board (for 3G model).



**NOTE:** For non-3G WLAN board module with 3 antenna cables connected to the WLAN board module. The black antenna cable is connected to the connector #1, the White antenna cable is connected to connector #2 and the Gray antenna cable is connected to connector #3.

**NOTE:** For non-3G WLAN board module with 2 antenna cables connected to the WLAN board module. The Black antenna cable is connected to the connector J2 and the Gray antenna cable is connected to connector J3.

10. Press the latch to pop up the WLAN card and detach the WLAN card from the WLAN socket.



**NOTE:** When attaching the antenna back to the WLAN board, make sure the cable are arranged properly.

## Removing the Optical Drive Module

1. See “Removing the Battery Pack” on page 44.
2. See “Removing the SD Dummy Card” on page 45.
3. See “Removing the DIMM Module” on page 46.
4. See “Removing the Back Cover” on page 47.
5. See “Removing the Hard Disk Drive Module” on page 48.
6. See “Removing the WLAN Modules” on page 51.

7. Use a screw driver to push out the locker bracket of the optical drive (ODD) module. Slowly pull out the ODD module from the ODD drive bay.



8. Remove the one screw (C) securing the locker bracket and remove the locker bracket from the optical disk drive module.

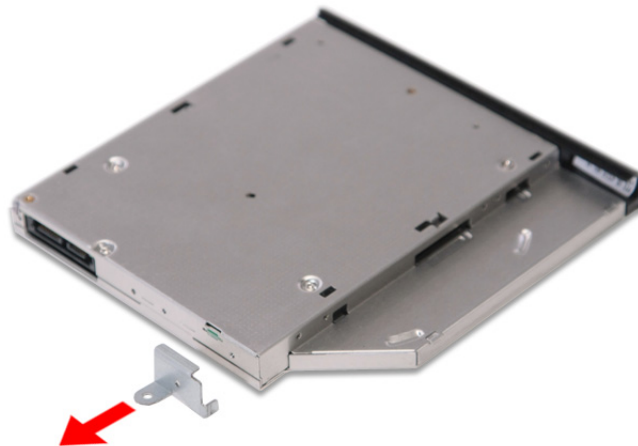

Size (Quantity)	Color	Torque	Part No.
M2 x L3 (1)	Silver	1.6 kgf-cm	86.9A552.3R0

# Main Unit Disassembly Process

## Main Unit Disassembly Flowchart

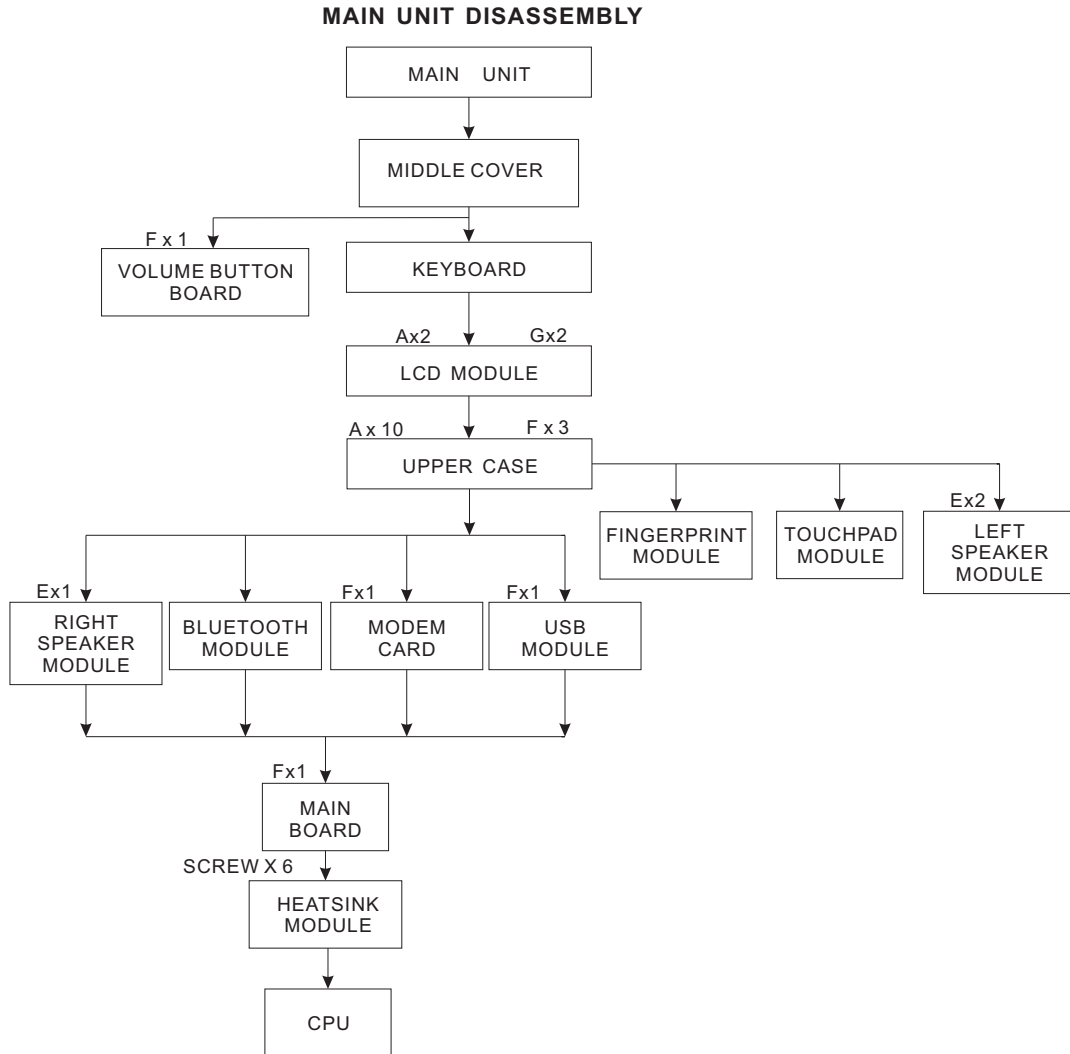

### Screw List

Item	Screw	Color	Part No.
A	M2.5 x L8	Black	86.00E34.738
E	M2 x L4	Black	86.00E13.524
F	M2 x L4	Silver	86.9A552.4R0
G	M2.5 x L10	Silver	86.1A553.100

---

## Removing the Middle Cover

1. See “Removing the Battery Pack” on page 44.
2. See “Removing the SD Dummy Card” on page 45.
3. See “Removing the DIMM Module” on page 46.
4. See “Removing the Back Cover” on page 47.
5. See “Removing the Hard Disk Drive Module” on page 48.
6. See “Removing the WLAN Modules” on page 51.
7. See “Removing the Optical Drive Module” on page 53.
8. Use a plastic screw driver to pry loose the side of the middle cover.



9. Carefully pry loose the middle cover from the latches securing it.





10. Detach the cable from the volume button board on the middle cover.



11. Remove the one screw (F) from the volume button board and release the volume button board from the latch.

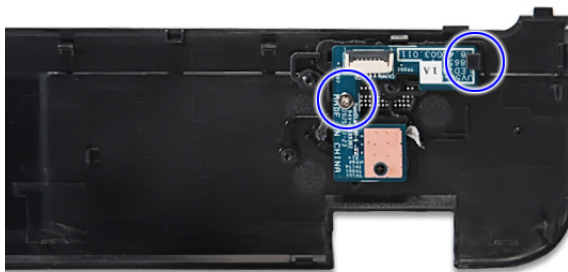

Size (Quantity)	Color	Torque	Part No.
M2 x L4 (1)	Silver	1.6 kgf-cm	86.9A552.4R0

- 
12. Detach the volume button board from the middle cover.

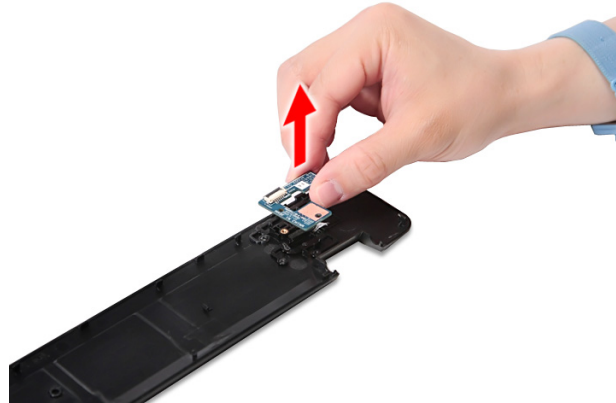

## Removing the Keyboard

1. See “Removing the Battery Pack” on page 44.
2. See “Removing the SD Dummy Card” on page 45.
3. See “Removing the DIMM Module” on page 46.
4. See “Removing the Back Cover” on page 47.
5. See “Removing the Hard Disk Drive Module” on page 48.
6. See “Removing the WLAN Modules” on page 51.
7. See “Removing the Optical Drive Module” on page 53.
8. See “Removing the Middle Cover” on page 56.
9. Release the keyboard from the latches and turn it over on the touchpad area.





10. Disconnect the keyboard cable from the main board and detach the keyboard.



## Removing the LCD Module

1. See “Removing the Battery Pack” on page 44.
2. See “Removing the SD Dummy Card” on page 45.
3. See “Removing the DIMM Module” on page 46.
4. See “Removing the Back Cover” on page 47.
5. See “Removing the Hard Disk Drive Module” on page 48.
6. See “Removing the WLAN Modules” on page 51.
7. See “Removing the Optical Drive Module” on page 53.
8. See “Removing the Middle Cover” on page 56.
9. See “Removing the Middle Cover” on page 56.
10. Release the cables from the latches.

For 3G model

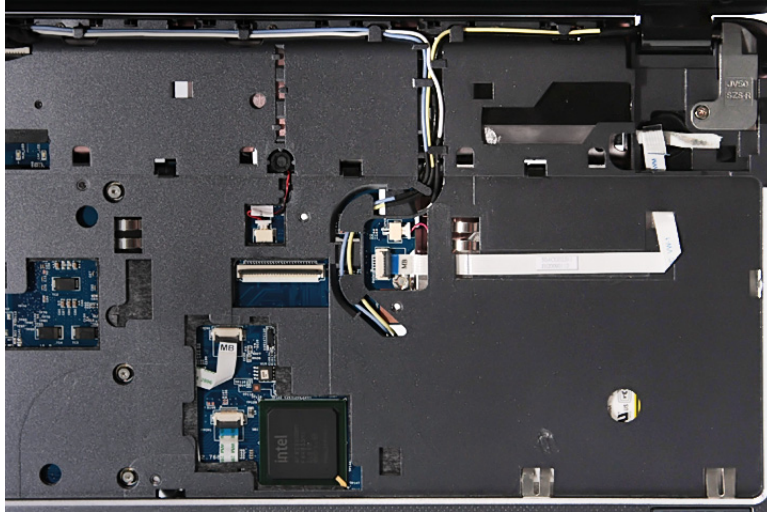

For non-3G model

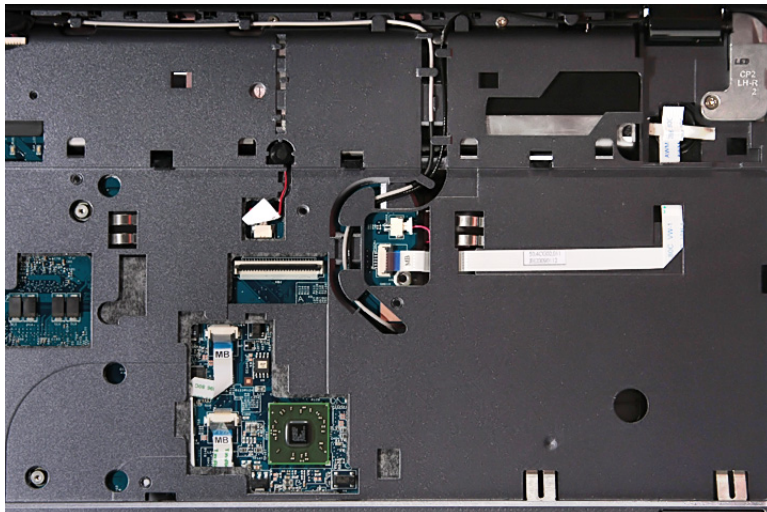

11. Carefully pull out the wireless antenna cables from the hole(s).
12. Release the cables from the latches.





13. Turn over the system and remove the two screws (A) from the bottom of the left and right hinges.

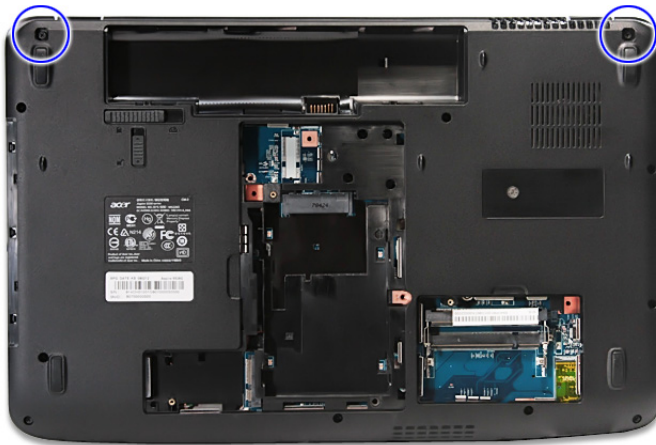

Size (Quantity)	Color	Torque	Part No.
M2.5 x L8 (2)	Black	3.0 kgf-cm	86.00E34.738

14. Detach the LCD cable from the connector on the main board.

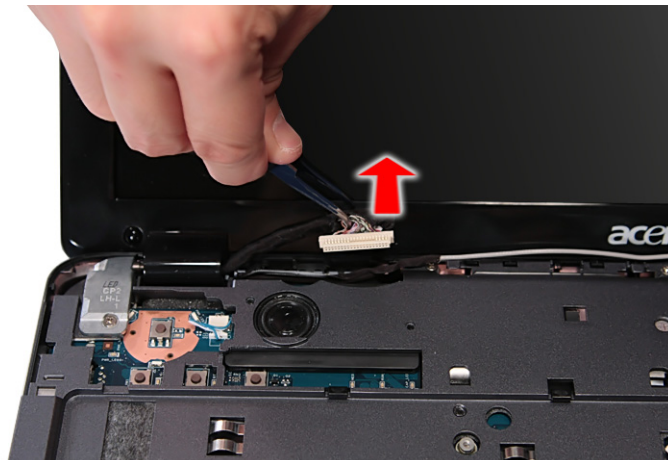

15. Remove the two screws (G) from the left and right hinge of the LCD module.

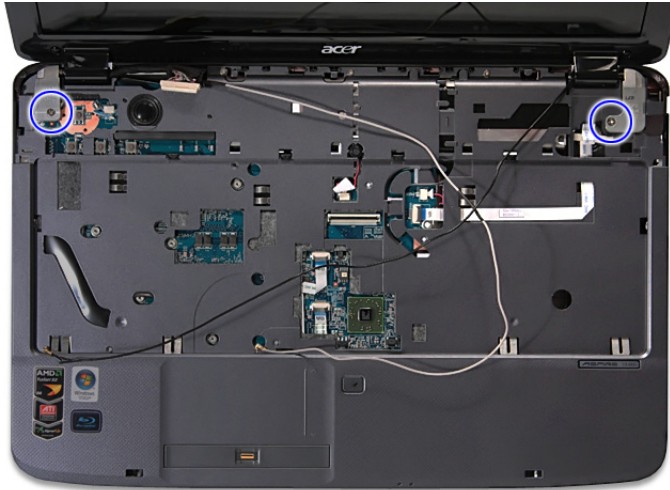

Size (Quantity)	Color	Torque	Part No.
M2.5 x L10 (2)	Silver	3.0 kgf-cm	86.1A553.100

16. Carefully remove the LCD module from the base unit.



**NOTE:** When connecting the cable back to the unit, please note that the cable should be routed well.

## Separating the Upper Case from the Lower Case

1. See "Removing the Battery Pack" on page 44.
2. See "Removing the SD Dummy Card" on page 45.
3. See "Removing the DIMM Module" on page 46.
4. See "Removing the Back Cover" on page 47.
5. See "Removing the Hard Disk Drive Module" on page 48.
6. See "Removing the WLAN Modules" on page 51.
7. See "Removing the Optical Drive Module" on page 53.
8. See "Removing the Middle Cover" on page 56.
9. See "Removing the Keyboard" on page 58.
10. See "Removing the LCD Module" on page 59.

11. Remove the three screws (F) from the middle cover.

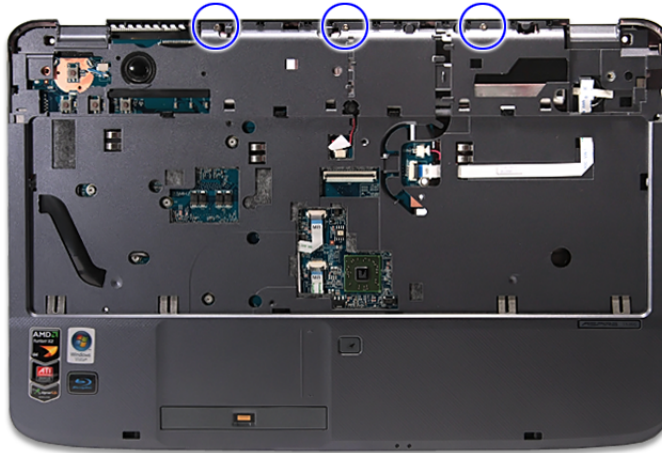

Size (Quantity)	Color	Torque	Part No.
M2 x L4 (3)	Silver	1.6 kgf-cm	86.9A552.4R0

12. Release the latch and disconnect the volume button board cable from its connector the main board.

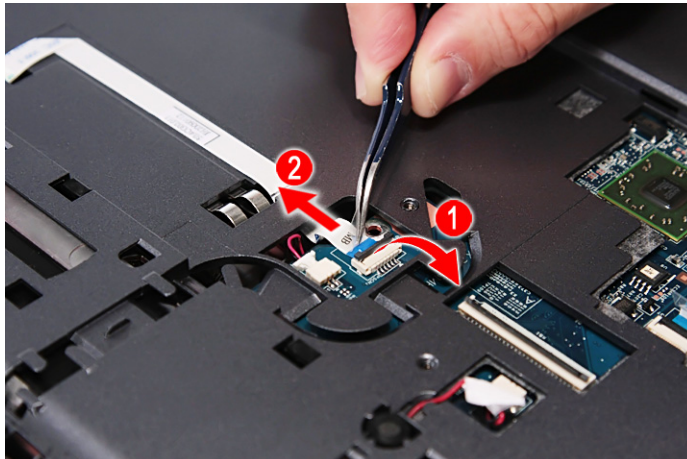

13. Release the latch and disconnect the touch pad cable from TPCN1 connector on the main board.

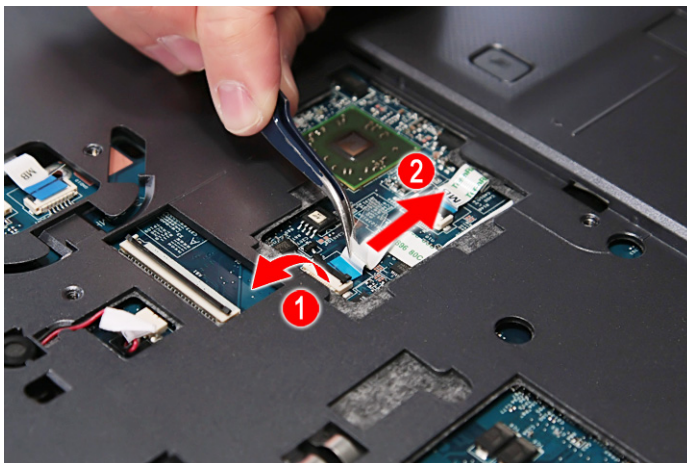

14. Release the latch and disconnect the fingerprint cable from FPCN1 connector on the main board.

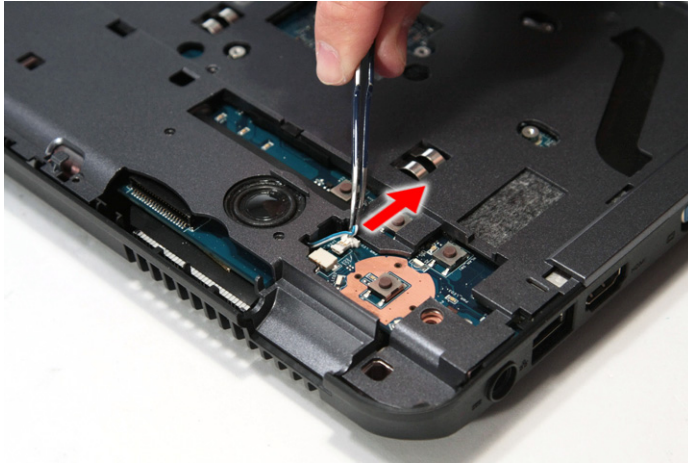

15. Disconnect the speaker cable from its connector on the main board.

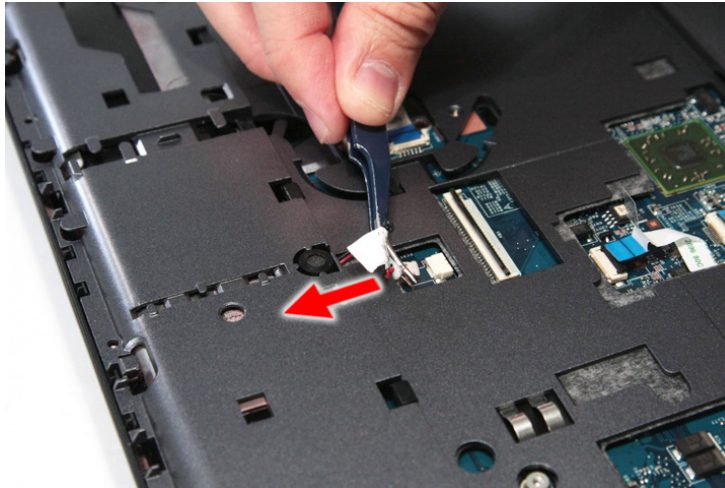

16. Disconnect the microphone connector from the main board and remove the microphone.

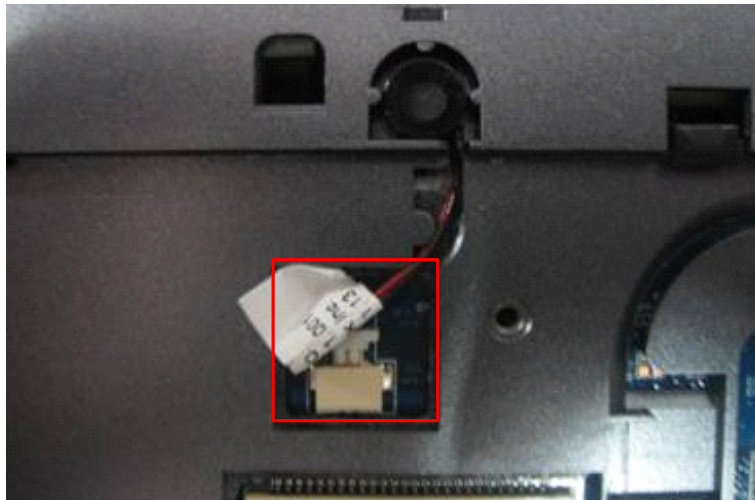



17. Remove the ten screws (A) securing the lower case to the upper case.

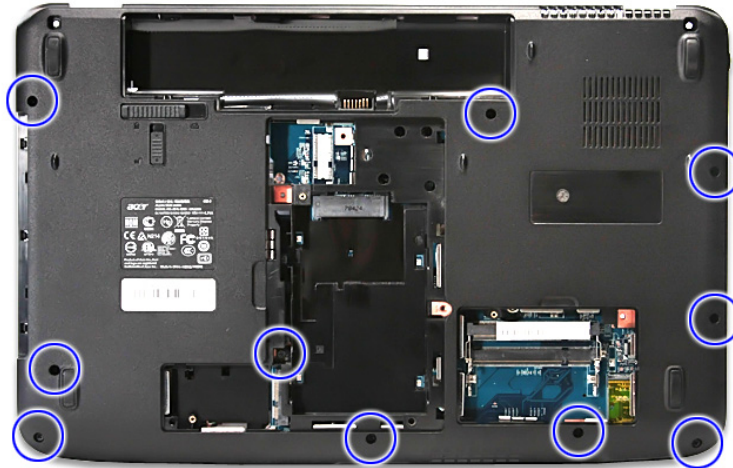

Size (Quantity)	Color	Torque	Part No.
M2.5 x L8 (10)	Black	3.0 kgf-cm	86.00E34.738

18. Gently detach the upper case from the lower case.



19. Remove the upper case.



---

## Removing the Fingerprint and Touchpad Boards

1. See “Removing the Battery Pack” on page 44.
2. See “Removing the SD Dummy Card” on page 45.
3. See “Removing the DIMM Module” on page 46.
4. See “Removing the Back Cover” on page 47.
5. See “Removing the Hard Disk Drive Module” on page 48.
6. See “Removing the WLAN Modules” on page 51.
7. See “Removing the Optical Drive Module” on page 53.
8. See “Removing the Middle Cover” on page 56.
9. See “Removing the Keyboard” on page 58.
10. See “Removing the LCD Module” on page 59.
11. See “Separating the Upper Case from the Lower Case” on page 62.
12. Release the latch and disconnect the fingerprint cable from the fingerprint board.

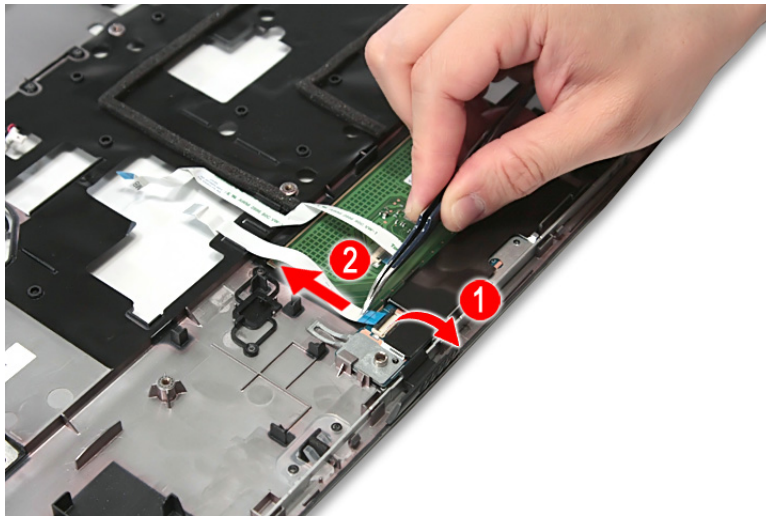

13. Release the latch and disconnect the the touchpad cable from the touchpad board.

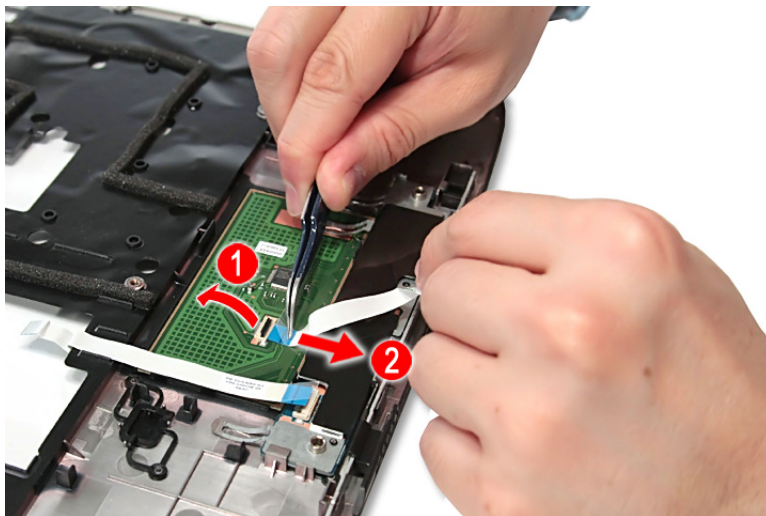

14. Release the fingerprint board metal bracket from the latches and detach it from the upper case.

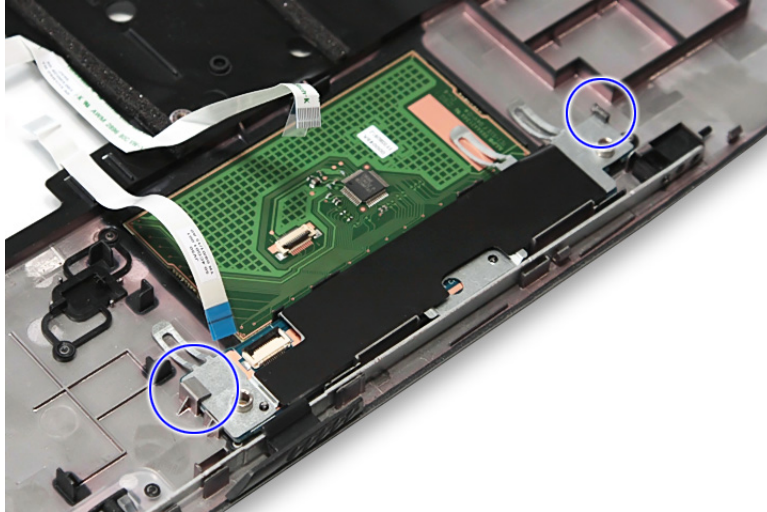

15. Release the fingerprint board from the latches and detach it from the upper case.

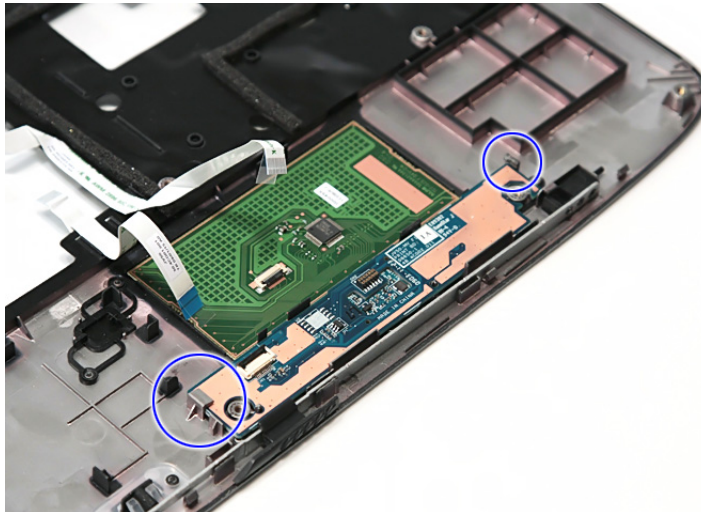

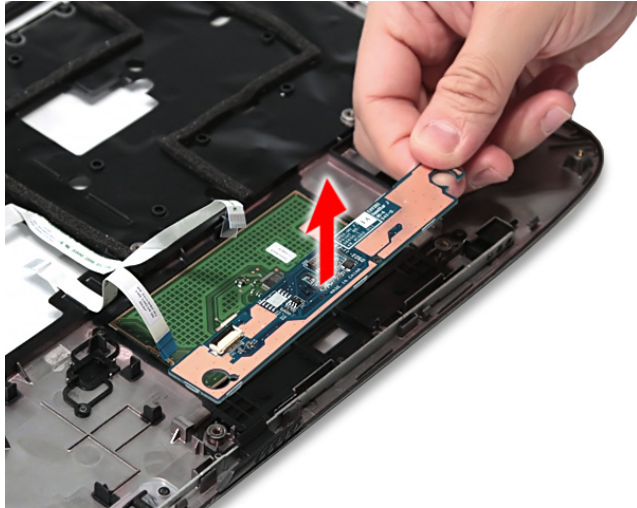

16. Pry to loosen the touchpad board.



**WARNING:** The touchpad board is glued to the upper case, only remove the touchpad board if it is defective.



**Note:** Circuit board >10 cm<sup>2</sup> has been highlighted with the yellow rectangle as above image shows. Please detach the Circuit boards and follow local regulations for disposal.

17. Detach the touchpad board from the upper case.

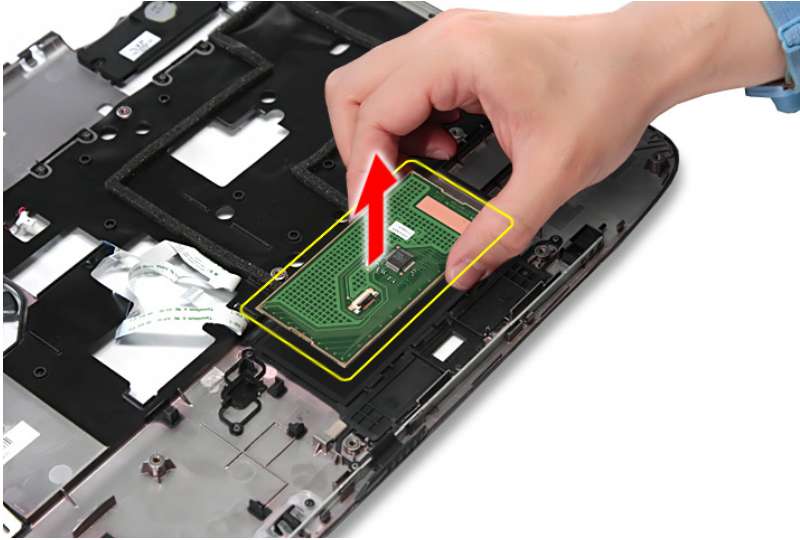

**Note:** Circuit boards > 10cm<sup>2</sup> has been highlighted with the yellow rectangle as shown in the figure above. Please detach the circuit boards and follow the local regulations for disposal.

## Removing the Left Speaker Module

1. See “Removing the Battery Pack” on page 44.
2. See “Removing the SD Dummy Card” on page 45.
3. See “Removing the DIMM Module” on page 46.
4. See “Removing the Back Cover” on page 47.
5. See “Removing the Hard Disk Drive Module” on page 48.
6. See “Removing the WLAN Modules” on page 51.
7. See “Removing the Optical Drive Module” on page 53.
8. See “Removing the Middle Cover” on page 56.
9. See “Removing the Keyboard” on page 58.
10. See “Removing the LCD Module” on page 59.
11. See “Separating the Upper Case from the Lower Case” on page 62.

12. Remove the two screws (E) securing the left speaker module and remove it from the upper case.

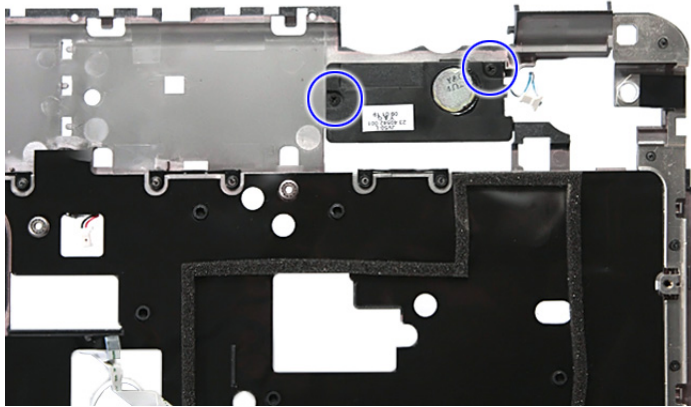

Size (Quantity)	Color	Torque	Part No.
M2 x L4 (2)	Black	1.6 kgf-cm	86.00E13.524

13. Detach the left speaker module.

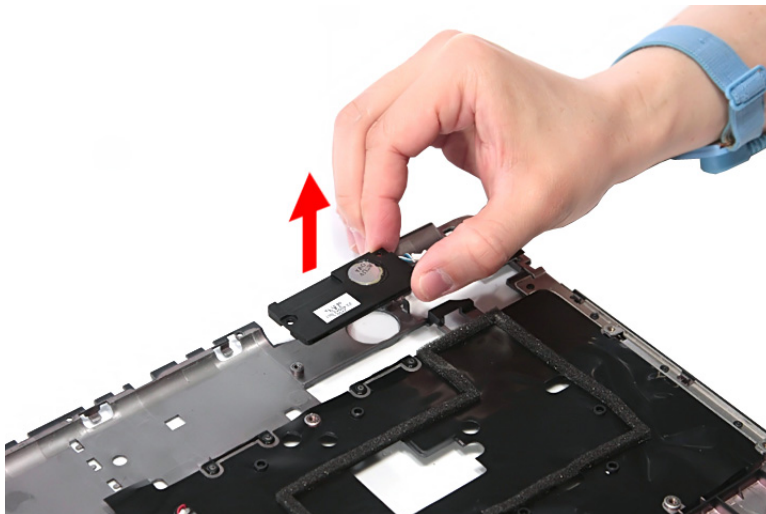

## Removing the USB Board Module

1. See "Removing the Battery Pack" on page 44.
2. See "Removing the SD Dummy Card" on page 45.
3. See "Removing the DIMM Module" on page 46.
4. See "Removing the Back Cover" on page 47.
5. See "Removing the Hard Disk Drive Module" on page 48.
6. See "Removing the WLAN Modules" on page 51.
7. See "Removing the Optical Drive Module" on page 53.
8. See "Removing the Middle Cover" on page 56.
9. See "Removing the Keyboard" on page 58.
10. See "Removing the LCD Module" on page 59.
11. See "Separating the Upper Case from the Lower Case" on page 62.

12. Disconnect the cables from the USB board module.

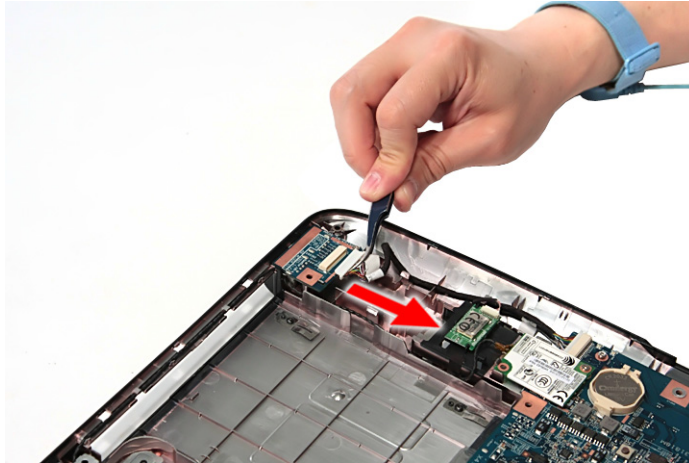

13. Remove the one screw (F) securing the USB board module to the lower case.

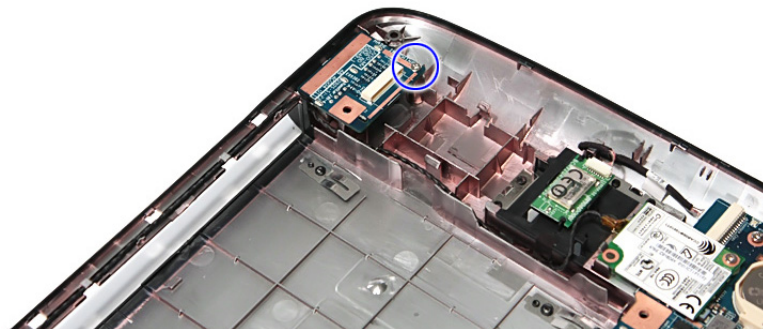

Size (Quantity)	Color	Torque	Part No.
M2 x L4 (1)	Silver	1.6 kgf-cm	86.9A552.4R0

14. Remove the USB board module from the lower case.



## Removing the Modem Module

1. See “Removing the Battery Pack” on page 44.
2. See “Removing the SD Dummy Card” on page 45.
3. See “Removing the DIMM Module” on page 46.
4. See “Removing the Back Cover” on page 47.
5. See “Removing the Hard Disk Drive Module” on page 48.
6. See “Removing the WLAN Modules” on page 51.
7. See “Removing the Optical Drive Module” on page 53.
8. See “Removing the Middle Cover” on page 56.
9. See “Removing the Keyboard” on page 58.
10. See “Removing the LCD Module” on page 59.
11. See “Separating the Upper Case from the Lower Case” on page 62.
12. See “Removing the Left Speaker Module” on page 69.
13. See “Removing the USB Board Module” on page 70.
14. Disconnect the modem cable from the main board.





15. Remove the one screws (F) securing the modem board module to the lower case.

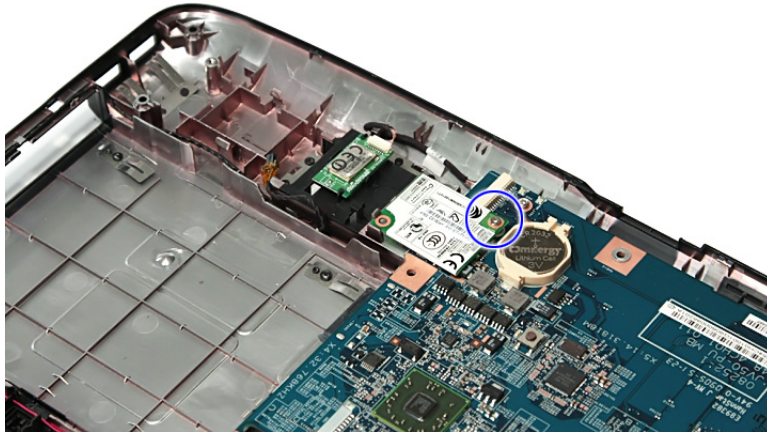

Size (Quantity)	Color	Torque	Part No.
M2 x L4 (1)	Silver	1.6 kgf-cm	86.9A552.4R0

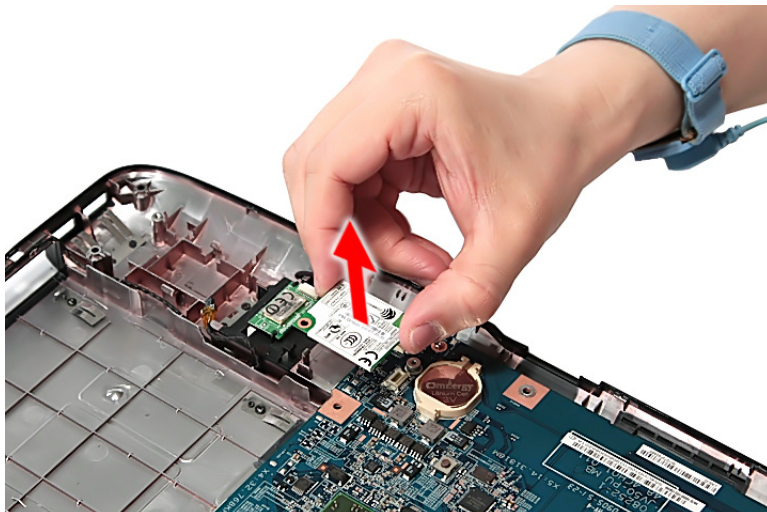

16. Release the modem board module from the latch and remove it from the lower case.

## Removing the Bluetooth Module

1. See "Removing the Battery Pack" on page 44.
2. See "Removing the SD Dummy Card" on page 45.
3. See "Removing the DIMM Module" on page 46.
4. See "Removing the Back Cover" on page 47.
5. See "Removing the Hard Disk Drive Module" on page 48.
6. See "Removing the WLAN Modules" on page 51.
7. See "Removing the Optical Drive Module" on page 53.
8. See "Removing the Middle Cover" on page 56.
9. See "Removing the Keyboard" on page 58.
10. See "Removing the LCD Module" on page 59.

11. See “Separating the Upper Case from the Lower Case” on page 62.
12. See “Removing the Left Speaker Module” on page 69.
13. See “Removing the USB Board Module” on page 70.
14. See “Removing the Modem Module” on page 72.
15. Disconnect the bluetooth cable from its connector on the main board.



16. Remove the Bluetooth module.



**NOTE:** Be careful when removing the Bluetooth module as it is glued in place.

---

## Removing the Right Speaker Module

1. See “Removing the Battery Pack” on page 44.
2. See “Removing the SD Dummy Card” on page 45.
3. See “Removing the DIMM Module” on page 46.
4. See “Removing the Back Cover” on page 47.
5. See “Removing the Hard Disk Drive Module” on page 48.
6. See “Remove the two screws (D) securing the hard disk to the bracket and remove the hard disk from the bracket.” on page 50.
7. See “Removing the Optical Drive Module” on page 53.
8. See “Removing the Middle Cover” on page 56.
9. See “Removing the Keyboard” on page 58.
10. See “Removing the LCD Module” on page 59.
11. See “Separating the Upper Case from the Lower Case” on page 62.
12. See “Removing the Left Speaker Module” on page 69.
13. See “Removing the USB Board Module” on page 70.
14. See “Removing the Modem Module” on page 72.
15. See “Removing the Bluetooth Module” on page 73.
16. Release right speaker cables from the latches.

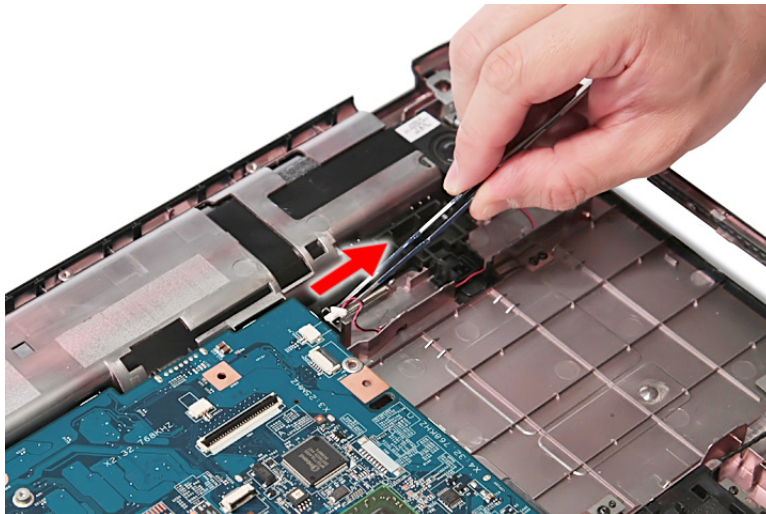

17. Disconnect the speaker cable from its connector on the main board.

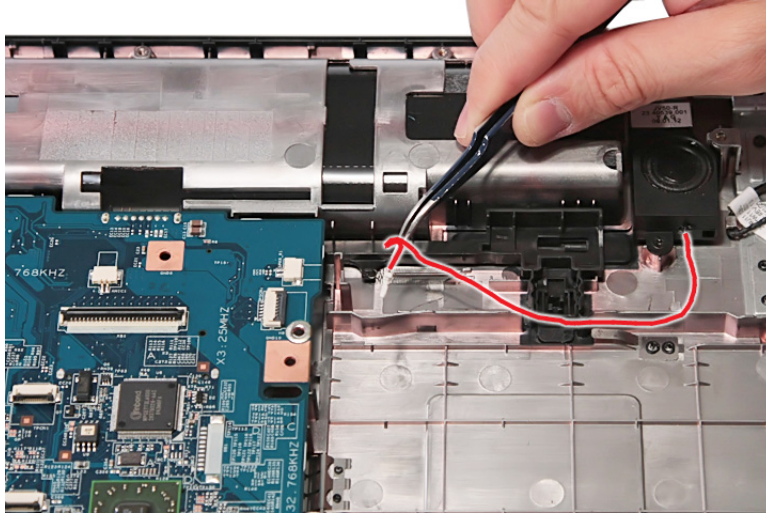

18. Remove the one screw (E) securing the speaker module and remove it from the lower case.

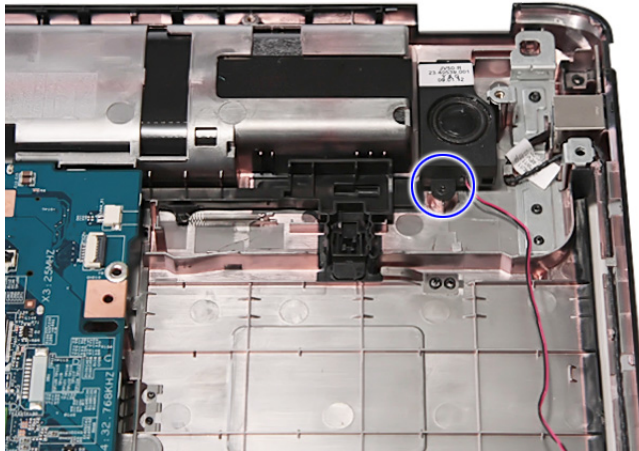

Size (Quantity)	Color	Torque	Part No.
M2 x L4 (1)	Black	1.6 kgf-cm	86.00E13.524

- 
19. Detach the right speaker module.

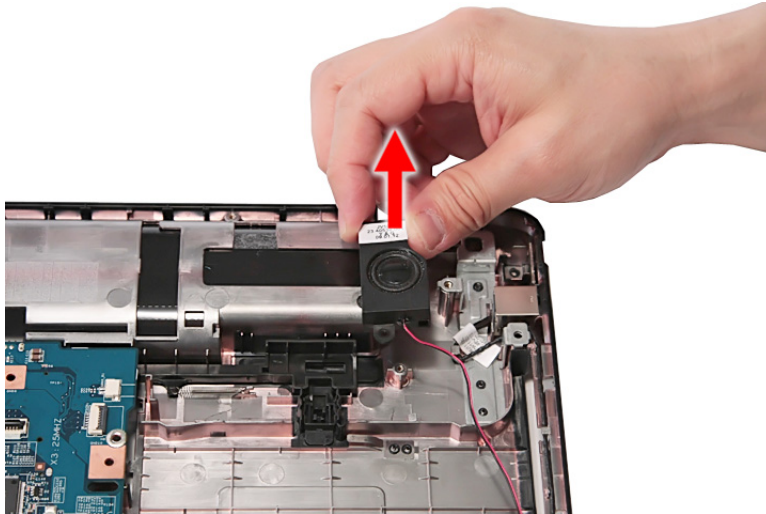

## Removing the Main Board

1. See “Removing the Battery Pack” on page 44.
2. See “Removing the SD Dummy Card” on page 45.
3. See “Removing the DIMM Module” on page 46.
4. See “Removing the Back Cover” on page 47.
5. See “Removing the Hard Disk Drive Module” on page 48.
6. See “Removing the WLAN Modules” on page 51.
7. See “Removing the Optical Drive Module” on page 53.
8. See “Removing the Middle Cover” on page 56.
9. See “Removing the Keyboard” on page 58.
10. See “Removing the LCD Module” on page 59.
11. See “Separating the Upper Case from the Lower Case” on page 62.
12. See “Removing the Left Speaker Module” on page 69.
13. See “Removing the USB Board Module” on page 70.
14. See “Removing the Modem Module” on page 72.
15. See “Removing the Bluetooth Module” on page 73.
16. See “Removing the Right Speaker Module” on page 75.

17. Remove one screw (F) securing the main board in place.

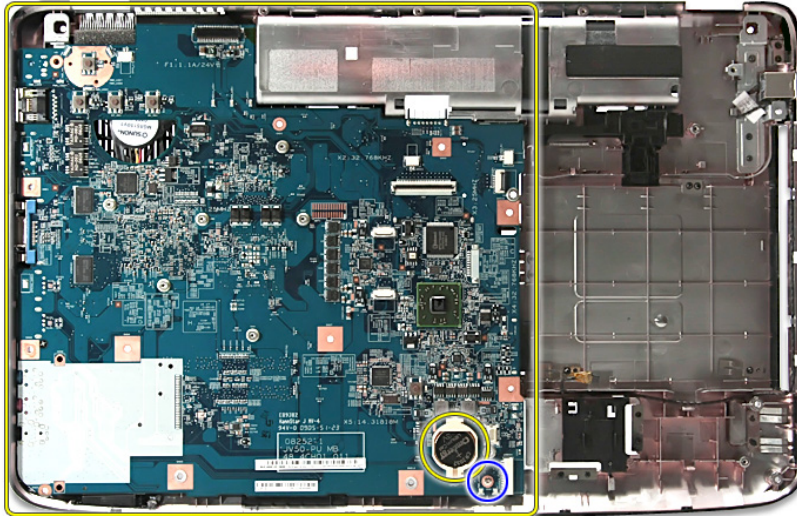

Size (Quantity)	Color	Torque	Part No.
M2 x L4 (1)	Silver	1.6 kgf-cm	86.9A552.4R0



**Note:** RTC battery has been highlighted with the yellow circle as shown in the figure above. Please detach the RTC battery and follow local regulations for disposal.



**Note:** Circuit boards >10 cm<sup>2</sup> has been highlighted with the yellow rectangle as above image shows. Please detach the Circuit boards and follow local regulations for disposal.

18. Lift the main board gently from the lower case.



---

19. Carefully remove the main board.

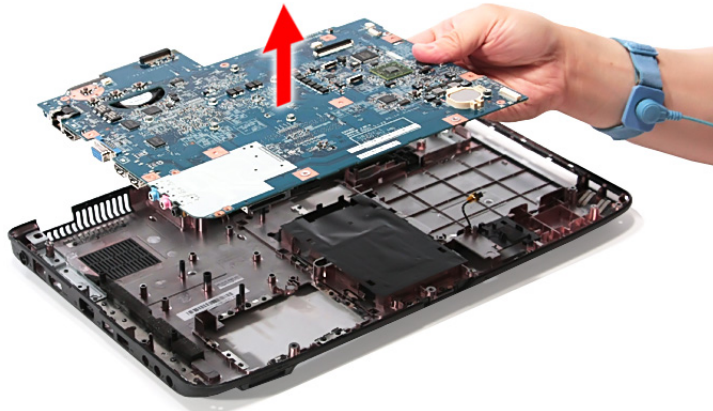

## Removing the Heatsink Module

**NOTE:** There are two version of heatsink module. For this section, we are going to use the discrete model. The UMA version looks like the picture below:



1. See “Removing the Battery Pack” on page 44.
2. See “Removing the SD Dummy Card” on page 45.
3. See “Removing the DIMM Module” on page 46.
4. See “Removing the Back Cover” on page 47.
5. See “Removing the Hard Disk Drive Module” on page 48.
6. See “Removing the WLAN Modules” on page 51.
7. See “Removing the Optical Drive Module” on page 53.
8. See “Removing the Middle Cover” on page 56.
9. See “Removing the Keyboard” on page 58.
10. See “Removing the LCD Module” on page 59.
11. See “Separating the Upper Case from the Lower Case” on page 62.
12. See “Removing the Left Speaker Module” on page 69.
13. See “Removing the USB Board Module” on page 70.
14. See “Removing the Modem Module” on page 72.
15. See “Removing the Bluetooth Module” on page 73.
16. See “Removing the Right Speaker Module” on page 75.

17. See “Removing the Main Board” on page 77.
18. Disconnect the heatsink connector from the main board.

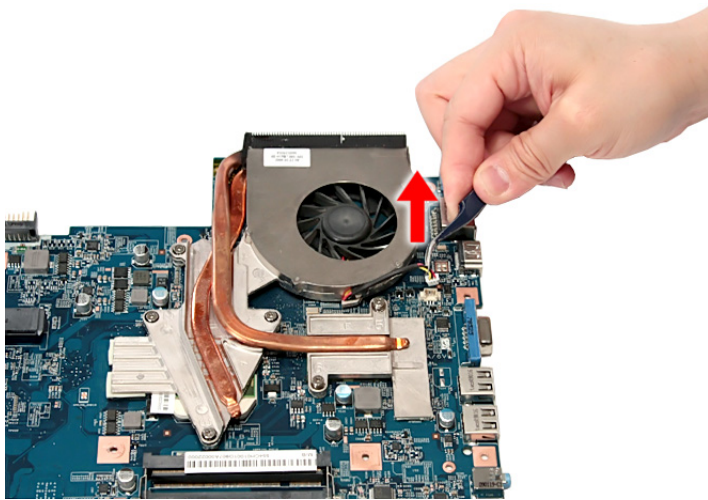

19. Remove the six screws securing the heatsink module in the order shown.

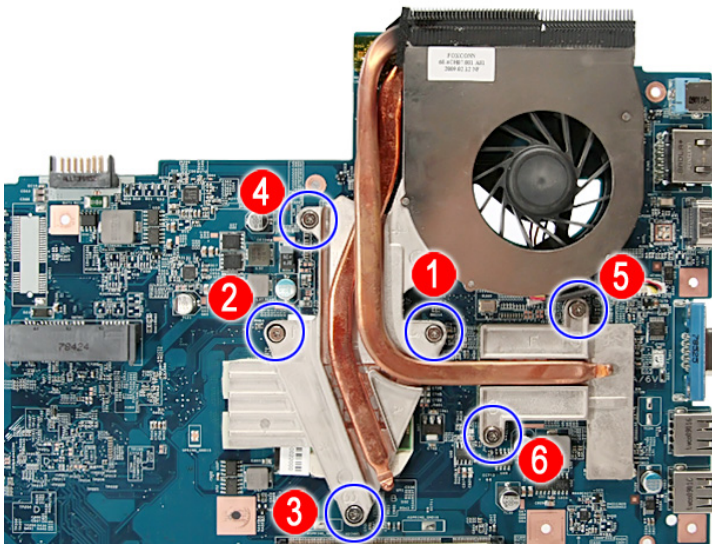

**NOTE:** The Discrete system may be shipped with NVdia or ATI VGA board.



- 
20. Carefully lift up the heatsink module.

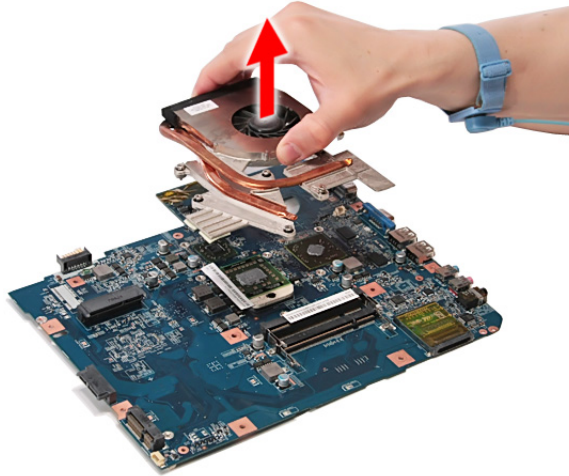

## Removing the CPU

**NOTE:** The CPU may be an Intel® processor or AMD® processor, but the processes in removing the CPU are the same.

1. See “Removing the Battery Pack” on page 44.
2. See “Removing the SD Dummy Card” on page 45.
3. See “Removing the DIMM Module” on page 46.
4. See “Removing the Back Cover” on page 47.
5. See “Removing the Hard Disk Drive Module” on page 48.
6. See “Removing the WLAN Modules” on page 51.
7. See “Removing the Optical Drive Module” on page 53.
8. See “Removing the Middle Cover” on page 56.
9. See “Removing the Keyboard” on page 58.
10. See “Removing the LCD Module” on page 59.
11. See “Separating the Upper Case from the Lower Case” on page 62.
12. See “Removing the Left Speaker Module” on page 69.
13. See “Removing the USB Board Module” on page 70.
14. See “Removing the Modem Module” on page 72.
15. See “Removing the Bluetooth Module” on page 73.
16. See “Removing the Right Speaker Module” on page 75.
17. See “Removing the Main Board” on page 77.
18. See “Removing the Heatsink Module” on page 79.

19. Using a flat screwdriver, turn the CPU socket latch counter-clockwise to release the CPU.

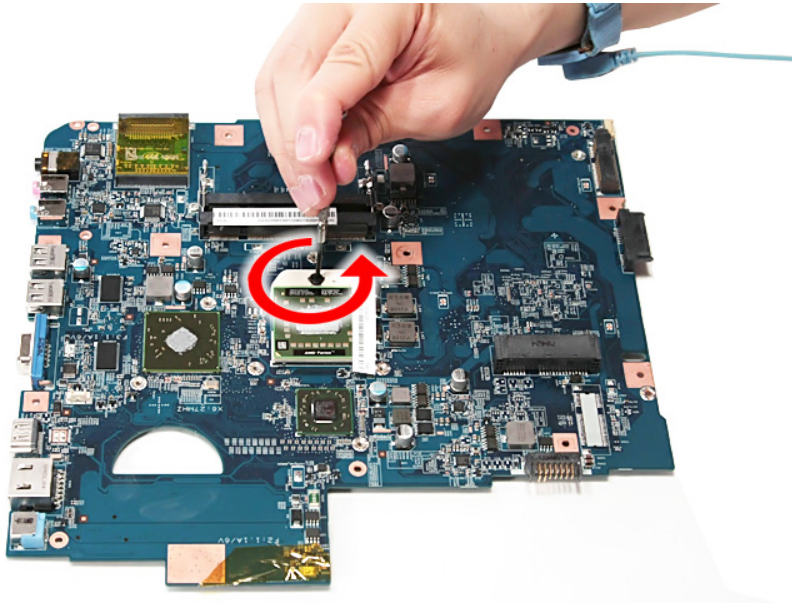

20. Lift up carefully to remove the CPU.

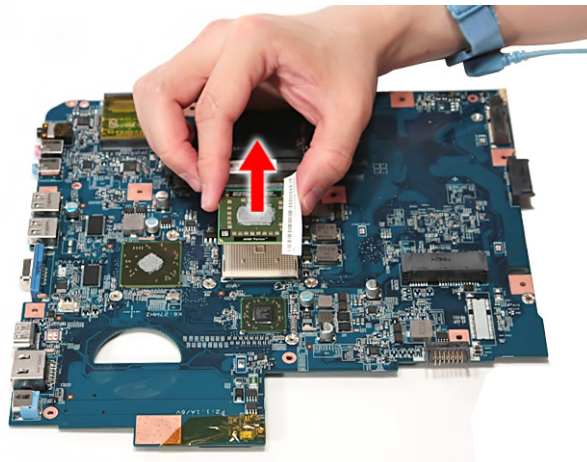

**NOTE:** When installing the CPU, make sure to install the CPU with PIN 1 at the corner as shown.

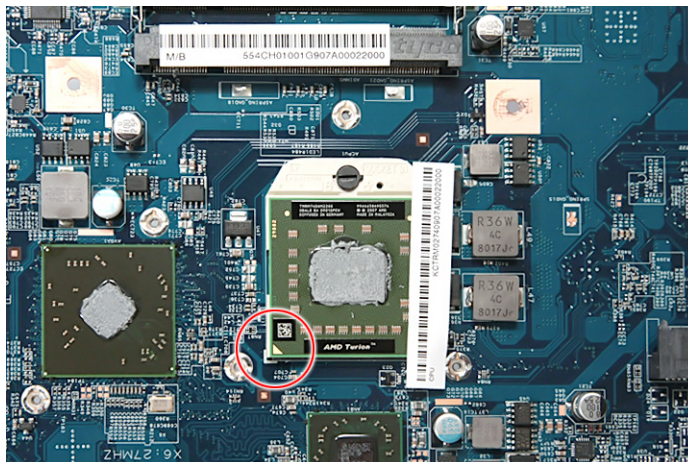

# LCD Module Disassembly Process

## LCD Module Disassembly Flowchart

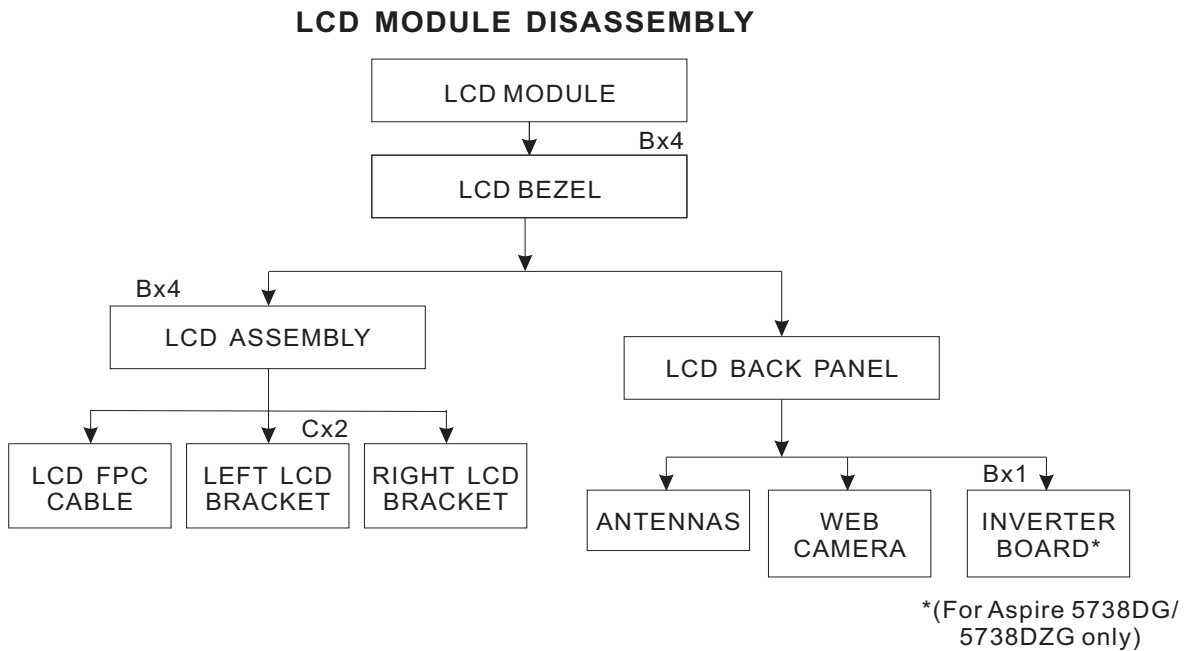

### Screw List

Item	Screw	Color	Part No.
B	M2.5 x L6	Black	86.00E12.536
C	M2 x L3	Silver	86.9A522.3R0

## Removing the LCD Bezel

1. See “Removing the Battery Pack” on page 44.
2. See “Removing the SD Dummy Card” on page 45.
3. See “Removing the DIMM Module” on page 46.
4. See “Removing the Back Cover” on page 47.
5. See “Removing the Hard Disk Drive Module” on page 48.
6. See “Removing the WLAN Modules” on page 51.
7. See “Removing the Optical Drive Module” on page 53.
8. See “Removing the Middle Cover” on page 56.
9. See “Removing the Keyboard” on page 58.
10. See “Removing the LCD Module” on page 59.
11. Remove the four screw covers from the top and bottom of the LCD bezel.



12. Remove the four screws (B) on the LCD module as shown.

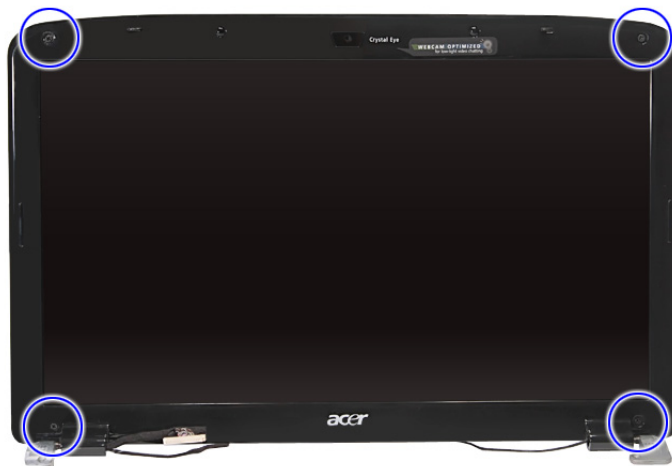

Size (Quantity)	Color	Torque	Part No.
M2.5 x L6 (4)	Black	3.0 kgf-cm	86.00E12.536

13. Carefully pry open the LCD bezel and remove it from the LCD panel.



**For Aspire 5738DG/5738DZG Series**



## Removing the Inverter Board (Aspire 5738DG/5738DZG Series only)

1. See “Removing the Battery Pack” on page 44.
2. See “Removing the SD Dummy Card” on page 45.
3. See “Removing the DIMM Module” on page 46.
4. See “Removing the Back Cover” on page 47.
5. See “Removing the Hard Disk Drive Module” on page 48.
6. See “Removing the WLAN Modules” on page 51.
7. See “Removing the Optical Drive Module” on page 53.
8. See “Removing the Middle Cover” on page 56.
9. See “Removing the Keyboard” on page 58.
10. See “Removing the LCD Module” on page 59.
11. See “Removing the LCD Bezel” on page 84.
12. Remove the one screw (B) on the inverter board.

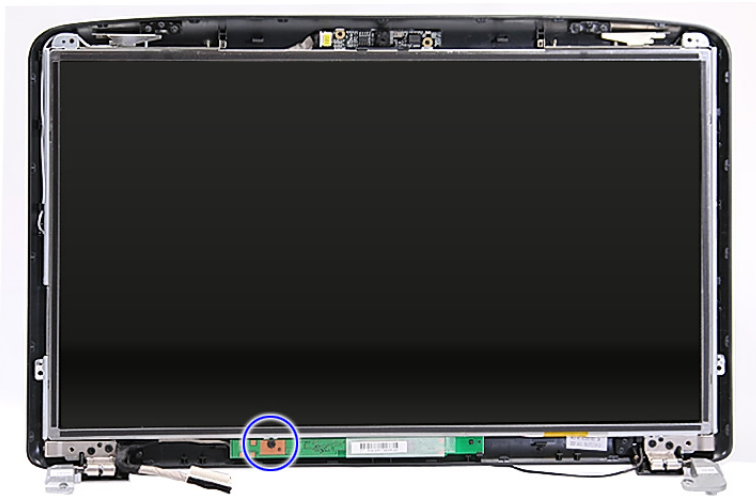

Size (Quantity)	Color	Torque	Part No.
M2.5 x L6 (1)	Black	3.0 kgf-cm	86.00E12.536

13. Release the inverter board from the latch

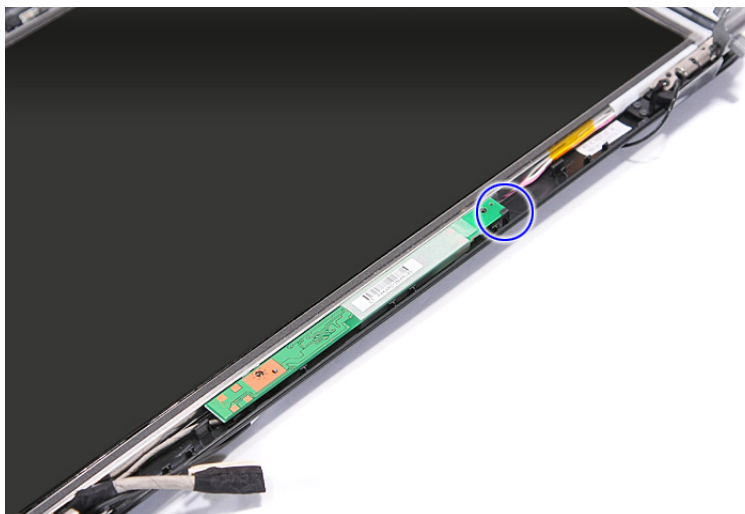

14. Turn the inverter board over on the LCD screen area.



15. Disconnect the cables from the connectors on the inverter board.



16. Remove the inverter board.

---

## Removing the LCD panel with the Brackets

1. See “Removing the Battery Pack” on page 44.
2. See “Removing the SD Dummy Card” on page 45.
3. See “Removing the DIMM Module” on page 46.
4. See “Removing the Back Cover” on page 47.
5. See “Removing the Hard Disk Drive Module” on page 48.
6. See “Removing the WLAN Modules” on page 51.
7. See “Removing the Optical Drive Module” on page 53.
8. See “Removing the Middle Cover” on page 56.
9. See “Removing the Keyboard” on page 58.
10. See “Removing the LCD Module” on page 59.
11. See “Removing the LCD Bezel” on page 84.
12. See “Removing the Inverter Board (Aspire 5738DG/5738DZG Series only)” on page 86.
13. Disconnect the cable from the web camera.





14. Remove the four screws (B) securing the LCD assembly.

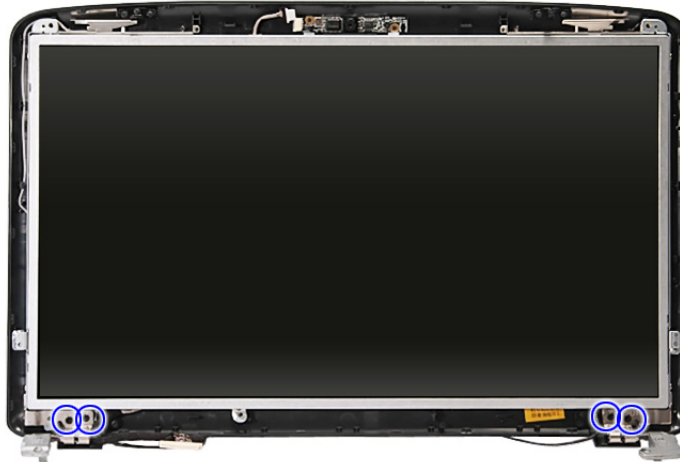

Size (Quantity)	Color	Torque	Part No.
M2.5 x L6 (4)	Black	3.0 kgf-cm	86.00E12.536

15. Remove the LCD with the brackets from the back cover.



## Removing the LCD Brackets

1. See "Removing the Battery Pack" on page 44.
2. See "Removing the SD Dummy Card" on page 45.
3. See "Removing the DIMM Module" on page 46.
4. See "Removing the Back Cover" on page 47.
5. See "Removing the Hard Disk Drive Module" on page 48.
6. See "Removing the WLAN Modules" on page 51.
7. See "Removing the Optical Drive Module" on page 53.
8. See "Removing the Middle Cover" on page 56.
9. See "Removing the Keyboard" on page 58.
10. See "Removing the LCD Module" on page 59.

11. See “Removing the LCD Bezel” on page 84.
12. See “Removing the Inverter Board (Aspire 5738DG/5738DZG Series only)” on page 86.
13. See “Removing the LCD panel with the Brackets” on page 88.
14. Remove the four screws (C) securing the left and right LCD brackets to remove the brackets.



Size (Quantity)	Color	Torque	Part No.
M2 x L3 (4)	Silver	1.6 kgf-cm	86.9A522.3R0

## Removing the FPC Cable

1. See “Removing the Battery Pack” on page 44.
2. See “Removing the SD Dummy Card” on page 45.
3. See “Removing the DIMM Module” on page 46.
4. See “Removing the Back Cover” on page 47.
5. See “Removing the Hard Disk Drive Module” on page 48.
6. See “Removing the WLAN Modules” on page 51.
7. See “Removing the Optical Drive Module” on page 53.
8. See “Removing the Middle Cover” on page 56.
9. See “Removing the Keyboard” on page 58.
10. See “Removing the LCD Module” on page 59.
11. See “Removing the LCD Bezel” on page 84.
12. See “Removing the Inverter Board (Aspire 5738DG/5738DZG Series only)” on page 86.
13. See “Removing the LCD panel with the Brackets” on page 88.
14. See “Removing the LCD Brackets” on page 89.

---

15. Detach any adhesive tapes and any cable that is glued to the LCD panel.



- 
16. Disconnect the FPC cable from the LCD panel.

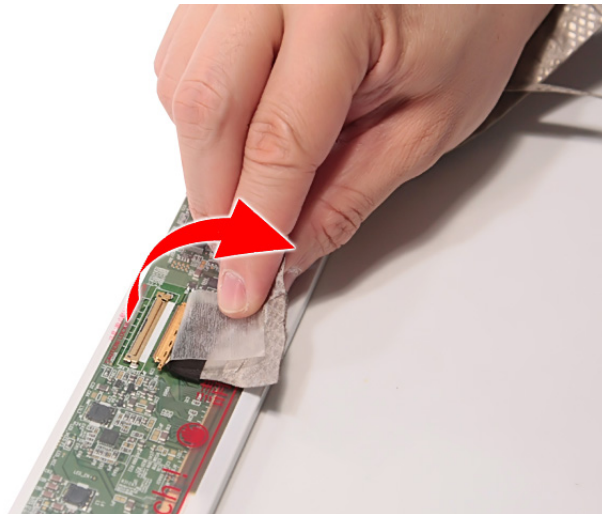
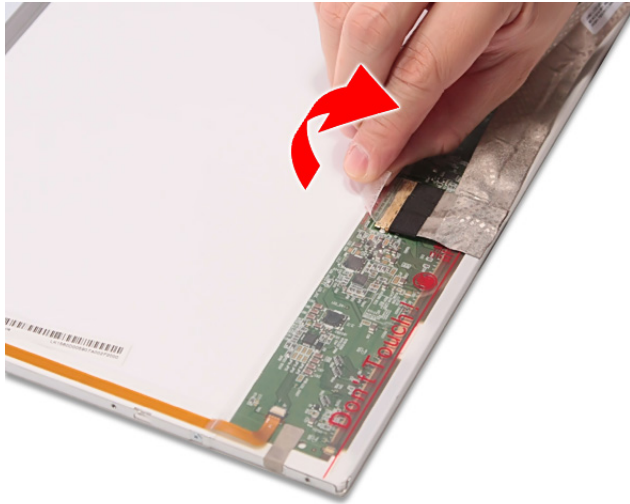

## Removing the Antennas

1. See “Removing the Battery Pack” on page 44.
2. See “Removing the SD Dummy Card” on page 45.
3. See “Removing the DIMM Module” on page 46.
4. See “Removing the Back Cover” on page 47.
5. See “Removing the Hard Disk Drive Module” on page 48.
6. See “Removing the WLAN Modules” on page 51.
7. See “Removing the Optical Drive Module” on page 53.
8. See “Removing the Middle Cover” on page 56.
9. See “Removing the Keyboard” on page 58.
10. See “Removing the LCD Module” on page 59.
11. See “Removing the LCD Bezel” on page 84.
12. See “Removing the Inverter Board (Aspire 5738DG/5738DZG Series only)” on page 86.
13. See “Removing the LCD panel with the Brackets” on page 88.

14. See “Removing the LCD Brackets” on page 89.
15. See “Removing the FPC Cable” on page 90.
16. Release the antenna cables from the aluminium tapes.

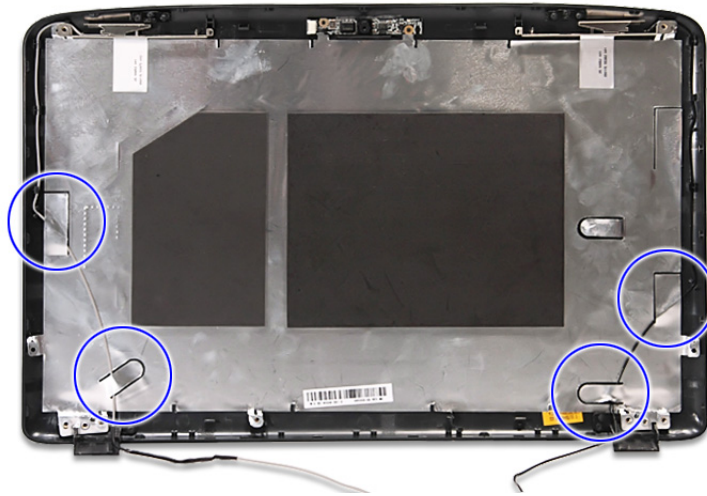

17. Remove the left and right antenna cables together with the tapes holding them in place.



**NOTE:** There is no need to remove the antenna unless you really need to replace it.

---

## Removing the Web Camera

1. See “Removing the Battery Pack” on page 44.
2. See “Removing the SD Dummy Card” on page 45.
3. See “Removing the DIMM Module” on page 46.
4. See “Removing the Back Cover” on page 47.
5. See “Removing the Hard Disk Drive Module” on page 48.
6. See “Removing the WLAN Modules” on page 51.
7. See “Removing the Optical Drive Module” on page 53.
8. See “Removing the Middle Cover” on page 56.
9. See “Removing the Keyboard” on page 58.
10. See “Removing the LCD Module” on page 59.
11. See “Removing the LCD Bezel” on page 84.
12. See “Removing the Inverter Board (Aspire 5738DG/5738DZG Series only)” on page 86.
13. Remove the web camera module from the LCD module back cover.

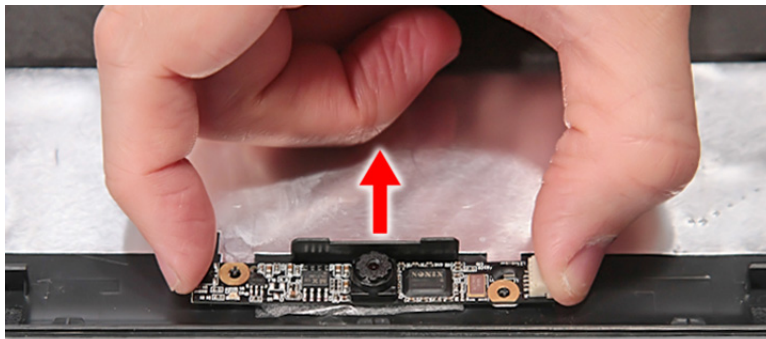

**NOTE:** The web camera module is glued to the LCD module back cover, only remove the web camera module if it is defective.

# Troubleshooting

Use the following procedure as a guide for computer problems.

**NOTE:** The diagnostic tests are intended to test only Acer products. Non-Acer products, prototype cards, or modified options can give false errors and invalid system responses.

1. Obtain the failing symptoms in as much detail as possible.
2. Verify the symptoms by attempting to re-create the failure by running the diagnostic test or by repeating the same operation.
3. Use the following table with the verified symptom to determine which page to go to.

Symptoms (Verified)	Go To
Power failure. (The power indicator does not go on or stay on.)	"Power System Check" on page 97.
POST does not complete. No beep or error codes are indicated.	"Power-On Self-Test (POST) Error Message" on page 98 "Undetermined Problems" on page 112
POST detects an error and displayed messages on screen.	"Error Message List" on page 99
Other symptoms (i.e. LCD display problems or others).	"Power-On Self-Test (POST) Error Message" on page 98
Symptoms cannot be re-created (intermittent problems).	Use the customer-reported symptoms and go to "Power-On Self-Test (POST) Error Message" on page 98 "Intermittent Problems" on page 111 "Undetermined Problems" on page 112

---

# System Check Procedures

## External Diskette Drive Check

Do the following to isolate the problem to a controller, driver, or diskette. A write-enabled, diagnostic diskette is required.

**NOTE:** Make sure that the diskette does not have more than one label attached to it. Multiple labels can cause damage to the drive or cause the drive to fail.

Do the following to select the test device.

1. Boot from the diagnostics diskette and start the diagnostics program.
2. See if FDD Test is passed as the program runs to FDD Test.
3. Follow the instructions in the message window.

If an error occurs with the internal diskette drive, reconnect the diskette connector on the system board.

If the error still remains:

1. Reconnect the external diskette drive/DVD-ROM module.
2. Replace the external diskette drive/CD-ROM module.
3. Replace the main board.

## External CD-ROM Drive Check

Do the following to isolate the problem to a controller, drive, or CD-ROM. Make sure that the CD-ROM does not have any label attached to it. The label can cause damage to the drive or can cause the drive to fail.

Do the following to select the test device:

1. Boot from the diagnostics diskette and start the diagnostics program.
2. See if CD-ROM Test is passed when the program runs to CD-ROM Test.
3. Follow the instructions in the message window.

If an error occurs, reconnect the connector on the System board. If the error still remains:

1. Reconnect the external diskette drive/CD-ROM module.
2. Replace the external diskette drive/CD-ROM module.
3. Replace the main board.

## Keyboard or Auxiliary Input Device Check

Remove the external keyboard if the internal keyboard is to be tested.

If the internal keyboard does not work or an unexpected character appears, make sure that the flexible cable extending from the keyboard is correctly seated in the connector on the system board.

If the keyboard cable connection is correct, run the Keyboard Test.

If the tests detect a keyboard problem, do the following one at a time to correct the problem. Do not replace a non-defective FRU:

1. Reconnect the keyboard cables.
2. Replace the keyboard.
3. Replace the main board.

The following auxiliary input devices are supported by this computer:

- Numeric keypad



- External keyboard

If any of these devices do not work, reconnect the cable connector and repeat the failing operation.

## Memory Check

Memory errors might stop system operations, show error messages on the screen, or hang the system.

1. Boot from the diagnostics diskette and start the diagnostic program (please refer to main board).
2. Go to the diagnostic memory in the test items.
3. Press F2 in the test items.
4. Follow the instructions in the message window.

**NOTE:** Make sure that the DIMM is fully installed into the connector. A loose connection can cause an error.

## Power System Check

To verify the symptom of the problem, power on the computer using each of the following power sources:

1. Remove the battery pack.
2. Connect the power adapter and check that power is supplied.
3. Disconnect the power adapter and install the charged battery pack; then check that power is supplied by the battery pack.

If you suspect a power problem, see the appropriate power supply check in the following list:

- “Check the Power Adapter” on page 97
- “Check the Battery Pack” on page 98

## Check the Power Adapter

Unplug the power adapter cable from the computer and measure the output voltage at the plug of the power adapter cable. See the following figure

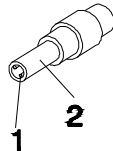

Pin 1: +19 to +20.5V

Pin 2: 0V, Ground

1. If the voltage is not correct, replace the power adapter.
2. If the voltage is within the range, do the following:
  - Replace the System board.
  - If the problem is not corrected, see “Undetermined Problems” on page 112.
  - If the voltage is not correct, go to the next step.

**NOTE:** An audible noise from the power adapter does not always indicate a defect.

3. If the power-on indicator does not light up, check the power cord of the power adapter for correct continuity and installation.
4. If the operational charge does not work, see “Check the Battery Pack” on page 98.

---

## Check the Battery Pack

To check the battery pack, do the following:

From Software:

1. Check out the Power Management in control Panel
2. In Power Meter, confirm that if the parameters shown in the screen for Current Power Source and Total Battery Power Remaining are correct.
3. Repeat the steps 1 and 2, for both battery and adapter.
4. This helps you identify first the problem is on recharging or discharging.

From Hardware:

1. Power off the computer.
2. Remove the battery pack and measure the voltage between battery terminals 1(+) and 6(ground).
3. If the voltage is still less than 7.5 Vdc after recharging, replace the battery.

To check the battery charge operation, use a discharged battery pack or a battery pack that has less than 50% of the total power remaining when installed in the computer.

If the battery status indicator does not light up, remove the battery pack and let it return to room temperature. Re-install the battery pack.

If the charge indicator still does not light up, replace the battery pack. If the charge indicator still does not light up, replace the DC/DC charger board.

## Touchpad Check

If the touchpad doesn't work, do the following actions one at a time to correct the problem. Do not replace a non-defective FRU:

1. Reconnect the touchpad cables.
2. Replace the touchpad.
3. Replace the system board.

After you use the touchpad, the pointer drifts on the screen for a short time. This self-acting pointer movement can occur when a slight, steady pressure is applied to the touchpad pointer. This symptom is not a hardware problem. No service actions are necessary if the pointer movement stops in a short period of time.

## Power-On Self-Test (POST) Error Message

The POST error message index lists the error message and their possible causes. The most likely cause is listed first.

**NOTE:** Perform the FRU replacement or actions in the sequence shown in FRU/Action column, if the FRU replacement does not solve the problem, put the original part back in the computer. Do not replace a non-defective FRU.

This index can also help you determine the next possible FRU to be replaced when servicing a computer.

If the symptom is not listed, see "Undetermined Problems" on page 112.

The following lists the error messages that the BIOS displays on the screen and the error symptoms classified by function.

**NOTE:** Most of the error messages occur during POST. Some of them display information about a hardware device, e.g., the amount of memory installed. Others may indicate a problem with a device, such as the way it has been configured.

**NOTE:** If the system fails after you make changes in the BIOS Setup Utility menus, reset the computer, enter Setup and install Setup defaults or correct the error.

# Index of Error Messages

## Error Code List

Error Codes	Error Messages
006	Equipment Configuration Error Causes: 1. CPU BIOS Update Code Mismatch 2. IDE Primary Channel Master Drive Error (The causes will be shown before "Equipment Configuration Error")
010	Memory Error at xxxx:xxxx:xxxxh (R:xxxxh, W:xxxxh)
070	Real Time Clock Error
071	CMOS Battery Bad
072	CMOS Checksum Error
110	System disabled. Incorrect password is specified.
<No error code>	Battery critical LOW In this situation BIOS will issue 4 short beeps then shut down system, no message will show.
<No error code>	Thermal critical High In this situation BIOS will shut down system, not show message.

## Error Message List

Error Messages	FRU/Action in Sequence
Failure Fixed Disk	Reconnect hard disk drive connector. "Load Default Settings" in BIOS Setup Utility. Hard disk drive System board
Stuck Key	see "Keyboard or Auxiliary Input Device Check" on page 96.
Keyboard error	see "Keyboard or Auxiliary Input Device Check" on page 96.
Keyboard Controller Failed	see "Keyboard or Auxiliary Input Device Check" on page 96.
Keyboard locked - Unlock key switch	Unlock external keyboard
Monitor type does not match CMOS - Run Setup	Run "Load Default Settings" in BIOS Setup Utility.
Shadow RAM Failed at offset: nnnn	BIOS ROM System board
System RAM Failed at offset: nnnn	DIMM System board
Extended RAM Failed at offset: nnnn	DIMM System board
System battery is dead - Replace and run Setup	Replace RTC battery and Run BIOS Setup Utility to reconfigure system time, then reboot system.
System CMOS checksum bad - Default configuration used	RTC battery Run BIOS Setup Utility to reconfigure system time, then reboot system.

## Error Message List

Error Messages	FRU/Action in Sequence
System timer error	RTC battery Run BIOS Setup Utility to reconfigure system time, then reboot system. System board
Real time clock error	RTC battery Run BIOS Setup Utility to reconfigure system time, then reboot system. System board
Previous boot incomplete - Default configuration used	Run "Load Default Settings" in BIOS Setup Utility. RTC battery System board
Memory size found by POST differed from CMOS	Run "Load Default Settings" in BIOS Setup Utility. DIMM System board
Diskette drive A error	Check the drive is defined with the proper diskette type in BIOS Setup Utility See "External Diskette Drive Check" on page 96.
Incorrect Drive A type - run SETUP	Check the drive is defined with the proper diskette type in BIOS Setup Utility
System cache error - Cache disabled	System board
CPU ID:	System board
DMA Test Failed	DIMM System board
Software NMI Failed	DIMM System board
Fail-Safe Timer NMI Failed	DIMM System board
Device Address Conflict	Run "Load Default Settings" in BIOS Setup Utility. RTC battery System board
Allocation Error for device	Run "Load Default Settings" in BIOS Setup Utility. RTC battery System board
Failing Bits: nnnn	DIMM BIOS ROM System board
Fixed Disk n	None
Invalid System Configuration Data	BIOS ROM System board
I/O device IRQ conflict	Run "Load Default Settings" in BIOS Setup Utility. RTC battery System board
Operating system not found	Enter Setup and see if fixed disk and drive A: are properly identified. Diskette drive Hard disk drive System board

**Error Message List**

No beep Error Messages	FRU/Action in Sequence
No beep, power-on indicator turns off and LCD is blank.	Power source (battery pack and power adapter). See "Power System Check" on page 97.. Ensure every connector is connected tightly and correctly. Reconnect the DIMM. LED board. System board.
No beep, power-on indicator turns on and LCD is blank.	Power source (battery pack and power adapter). See "Power System Check" on page 97.. Reconnect the LCD connector Hard disk drive LCD inverter ID LCD cable LCD Inverter LCD System board
No beep, power-on indicator turns on and LCD is blank. But you can see POST on an external CRT.	Reconnect the LCD connectors. LCD inverter ID LCD cable LCD inverter LCD System board
No beep, power-on indicator turns on and a blinking cursor shown on LCD during POST.	Ensure every connector is connected tightly and correctly. System board
No beep during POST but system runs correctly.	Speaker System board

# Phoenix BIOS Beep Codes

Code	Beeps	POST Routine Description
02h		Verify Real Mode
03h		Disable Non-Maskable Interrupt (NMI)
04h		Get CPU type
06h		Initialize system hardware
08h		Initialize chipset with initial POST values
09h		Set IN POST flag
0Ah		Initialize CPU registers
0Bh		Enable CPU cache
0Ch		Initialize caches to initial POST values
0Eh		Initialize I/O component
0Fh		Initialize the local bus IDE
10h		Initialize Power Management
11h		Load alternate registers with initial POST values
12h		Restore CPU control word during warm boot
13h		Initialize PCI Bus Mastering devices
14h		Initialize keyboard controller
16h	1-2-2-3	BIOS ROM checksum
17h		Initialize cache before memory autosize
18h		8254 timer initialization
1Ah		8237 DMA controller initialization
1Ch		Reset Programmable Interrupt Controller
20h	1-3-1-1	Test DRAM refresh
22h	1-3-1-3	Test 8742 Keyboard Controller
24h		Set ES segment register to 4 GB
26h		Enable A20 line
28h		Autosize DRAM
29h		Initialize POST Memory Manager
2Ah		Clear 215 KB base RAM
2Ch	1-3-4-1	RAM failure on address line xxxx
2Eh	1-3-4-3	RAM failure on data bits xxxx of low byte of memory bus
2Fh		Enable cache before system BIOS shadow
30h	1-4-1-1	RAM failure on data bits xxxx of high byte of memory bus
32h		Test CPU bus-clock frequency
33h		Initialize Phoenix Dispatch Manager
36h		Warm start shut down
38h		Shadow system BIOS ROM
3Ah		Autosize cache

Code	Beeps	POST Routine Description
3Ch		Advanced configuration of chipset registers
3Dh		Load alternate registers with CMOS values
42h		Initialize interrupt vectors
45h		POST device initialization
46h	2-1-2-3	Check ROM copyright notice
48h		Check video configuration against CMOS
49h		Initialize PCI bus and devices
4Ah		Initialize all video adapters in system
4Bh		QuietBoot start (optional)
4Ch		Shadow video BIOS ROM
4Eh		Display BIOS copyright notice
50h		Display CPU type and speed
51h		Initialize EISA board
52h		Test keyboard
54h		Set key click if enabled
58h	2-2-3-1	Test for unexpected interrupts
59h		Initialize POST display service
5Ah		Display prompt "Press F2 to enter SETUP"
5Bh		Disable CPU cache
5Ch		Test RAM between 512 and 640 KB
60h		Test extended memory
62h		Test extended memory address lines
64h		Jump to User Patch1
66h		Configure advanced cache registers
67h		Initialize Multi Processor APIC
68h		Enable external and CPU caches
69h		Setup System Management Mode (SMM) area
6Ah		Display external L2 cache size
6Bh		Load custom defaults (optional)
6Ch		Display shadow-area message
6Eh		Display possible high address for UMB recovery
70h		Display error messages
72h		Check for configuration errors
76h		Check for keyboard errors
7Ch		Set up hardware interrupt vectors
7Eh		Initialize coprocessor if present
80h		Disable onboard Super I/O ports and IRQs
81h		Late POST device initialization

Code	Beeps	POST Routine Description
82h		Detect and install external RS232 ports
83h		Configure non-MCD IDE controllers
84h		Detect and install external parallel ports
85h		Initialize PC-compatible PnP ISA devices
86h		Re-initialize onboard I/O ports
87h		Configure Motherboard Configurable Devices (optional)
88h		Initialize BIOS Area
89h		Enable Non-Maskable Interrupts (NMIs)
8Ah		Initialize Extended BIOS Data Area
8Bh		Test and initialize PS/2 mouse
8Ch		Initialize floppy controller
8Fh		Determine number of ATA drives (optional)
90h		Initialize hard-disk controllers
91h		Initialize local-bus hard-disk controllers
92h		Jump to UserPatch2
93h		Build MPTABLE for multi-processor boards
95h		Install CD ROM for boot
96h		Clear huge ES segment register
97h		Fixup Multi Processor table
98h	1-2	Search for option ROMs. One long, two short beeps on checksum failure.
99h		Check for SMART drive (optional)
9Ah		Shadow option ROMs
9Ch		Set up Power Management
9Dh		Initialize security engine (optional)
9Eh		Enable hardware interrupts
9Fh		Determine number of ATA and SCSI drives
A0h		Set time of day
A2h		Check key lock
A4h		Initialize Typematic rate
A8h		Erase F2 prompt
AAh		Scan for F2 key stroke
ACh		Enter SETUP
A Eh		Clear Boot flag
B0h		Check for errors
B2h		POST done- prepare to boot operating system
B4h	1	One short beep before boot
B5h		Terminate QuietBoot (optional)
B6h		Check password (optional)



Code	Beeps	POST Routine Description
B9h		Prepare Boot
BAh		Initialize DMI parameters
BBh		Initialize PnP Option ROMs
BCh		Clear parity checkers
BDh		Display MultiBoot menu
BEh		Clear screen (optional)
BFh		Check virus and backup reminders
C0h		Try to boot with INT 19
C1h		Initialize POST Error Manager (PEM)
C2h		Initialize error logging
C3h		Initialize error display function
C4h		Initialize system error handler
C5h		PnPnd dual CMOS (optional)
C6h		Initialize notebook docking (optional)
C7h		Initialize notebook docking late
C8h		Force check (optional)
C9h		Extended checksum (optional)
D2h		Unknown interrupt

Code	Beeps	POST Routine Description
E0h		Initialize the chipset
E1h		Initialize the bridge
E2h		Initialize the CPU
E3h		Initialize the system timer
E4h		Initialize system I/O
E5h		Check force recovery boot
E6h		Checksum BIOS ROM
E7h		Go to BIOS
E8h		Set Huge Segment
E9h		Initialize Multi Processor
EAh		Initialize OEM special code
EBh		Initialize PIC and DMA
ECh		Initialize Memory type
EDh		Initialize Memory size
EEh		Shadow Boot Block
EFh		System memory test
F0h		Initialize interrupt vectors
F1h		Initialize Run Time Clock
F2h		Initialize video
F3h		Initialize System Management Mode
F4h	1	Output one beep before boot

---

<b>Code</b>	<b>Beeps</b>	
F5h		Boot to Mini DOS
F6h		Clear Huge Segment
F7h		Boot to Full DOS

# Index of Symptom-to-FRU Error Message

## LCD-Related Symptoms

Symptom / Error	Action in Sequence
LCD backlight doesn't work LCD is too dark LCD brightness cannot be adjusted LCD contrast cannot be adjusted	Enter BIOS Utility to execute "Load Setup Default Settings", then reboot system. Reconnect the LCD connectors. Keyboard (if contrast and brightness function key doesn't work). LCD inverter ID LCD cable LCD inverter LCD System board
Unreadable LCD screen Missing pels in characters Abnormal screen Wrong color displayed	Reconnect the LCD connector LCD inverter ID LCD cable LCD inverter LCD System board
LCD has extra horizontal or vertical lines displayed.	LCD inverter ID LCD inverter LCD cable LCD System board

## Indicator-Related Symptoms

Symptom / Error	Action in Sequence
Indicator incorrectly remains off or on, but system runs correctly	Reconnect the inverter board Inverter board System board

## Power-Related Symptoms

Symptom / Error	Action in Sequence
Power shuts down during operation	Power source (battery pack and power adapter). See "Power System Check" on page 97. Battery pack Power adapter Hard drive & battery connection board System board
The system doesn't power-on.	Power source (battery pack and power adapter). See "Power System Check" on page 97. Battery pack Power adapter Hard drive & battery connection board System board

### Power-Related Symptoms

Symptom / Error	Action in Sequence
The system doesn't power-off.	Power source (battery pack and power adapter). See "Power System Check" on page 97. Hold and press the power switch for more than 4 seconds. System board
Battery can't be charged	See "Check the Battery Pack" on page 98. Battery pack System board

### PCMCIA-Related Symptoms

Symptom / Error	Action in Sequence
System cannot detect the PC Card (PCMCIA)	PCMCIA slot assembly System board
PCMCIA slot pin is damaged.	PCMCIA slot assembly

### Memory-Related Symptoms

Symptom / Error	Action in Sequence
Memory count (size) appears different from actual size.	Enter BIOS Setup Utility to execute "Load Default Settings, then reboot system. DIMM System board

### Speaker-Related Symptoms

Symptom / Error	Action in Sequence
In Windows, multimedia programs, no sound comes from the computer.	Audio driver Speaker System board
Internal speakers make noise or emit no sound.	Speaker System board

### Power Management-Related Symptoms

Symptom / Error	Action in Sequence
The system will not enter hibernation	See "Save to Disk (S4)" on page 26. Keyboard (if control is from the keyboard) Hard disk drive System board
The system doesn't enter hibernation mode and four short beeps every minute.	Press Fn+0 and see if the computer enters hibernation mode. Touchpad Keyboard Hard disk connection board Hard disk drive System board
The system doesn't enter standby mode after closing the LCD	See "Save to Disk (S4)" on page 26. LCD cover switch System board

### Power Management-Related Symptoms

Symptom / Error	Action in Sequence
The system doesn't resume from hibernation mode.	See "Save to Disk (S4)" on page 26. Hard disk connection board Hard disk drive System board
The system doesn't resume from standby mode after opening the LCD.	See "Save to Disk (S4)" on page 26. LCD cover switch System board
Battery fuel gauge in Windows doesn't go higher than 90%.	Remove battery pack and let it cool for 2 hours. Refresh battery (continue use battery until power off, then charge battery). Battery pack System board
System hangs intermittently.	Reconnect hard disk/CD-ROM drives. Hard disk connection board System board

### Peripheral-Related Symptoms

Symptom / Error	Action in Sequence
System configuration does not match the installed devices.	Enter BIOS Setup Utility to execute "Load Default Settings", then reboot system. Reconnect hard disk/CD-ROM/diskette drives.
External display does not work correctly.	Press Fn+F5, LCD/CRT/Both display switching System board
USB does not work correctly	System board
Print problems.	Onboard Devices Configuration Run printer self-test. Printer driver Printer cable Printer System Board
Serial or parallel port device problems.	Device driver Device cable Device System board

### Keyboard/Touchpad-Related Symptoms

Symptom / Error	Action in Sequence
Keyboard (one or more keys) does not work.	Reconnect the keyboard cable. Keyboard System board
Touchpad does not work.	Reconnect touchpad cable. Touchpad board System board

---

### Modem-Related Symptoms

Symptom / Error	Action in Sequence
Internal modem does not work correctly.	Modem phone port modem combo board System board

**NOTE:** If you cannot find a symptom or an error in this list and the problem remains, see “Undetermined Problems” on page 112.

---

# Intermittent Problems

Intermittent system hang problems can be caused by a variety of reasons that have nothing to do with a hardware defect, such as: cosmic radiation, electrostatic discharge, or software errors. FRU replacement should be considered only when a recurring problem exists.

When analyzing an intermittent problem, do the following:

1. Run the advanced diagnostic test for the system board in loop mode at least 10 times.
2. If no error is detected, do not replace any FRU.
3. If any error is detected, replace the FRU. Rerun the test to verify that there are no more errors.

---

# Undetermined Problems

The diagnostic problems does not identify which adapter or device failed, which installed devices are incorrect, whether a short circuit is suspected, or whether the system is inoperative.

Follow these procedures to isolate the failing FRU (do not isolate non-defective FRU).

**NOTE:** Verify that all attached devices are supported by the computer.

**NOTE:** Verify that the power supply being used at the time of the failure is operating correctly. (See "Power System Check" on page 97.):

1. Power-off the computer.
2. Visually check them for damage. If any problems are found, replace the FRU.
3. Remove or disconnect all of the following devices:
  - Non-Acer devices
  - Printer, mouse, and other external devices
  - Battery pack
  - Hard disk drive
  - DIMM
  - CD-ROM/Diskette drive Module
  - PC Cards
4. Power-on the computer.
5. Determine if the problem has changed.
6. If the problem does not recur, reconnect the removed devices one at a time until you find the failing FRU.
7. If the problem remains, replace the following FRU one at a time. Do not replace a non-defective FRU:
  - System board
  - LCD assembly



# Connector Locations

## Main Board

Top View

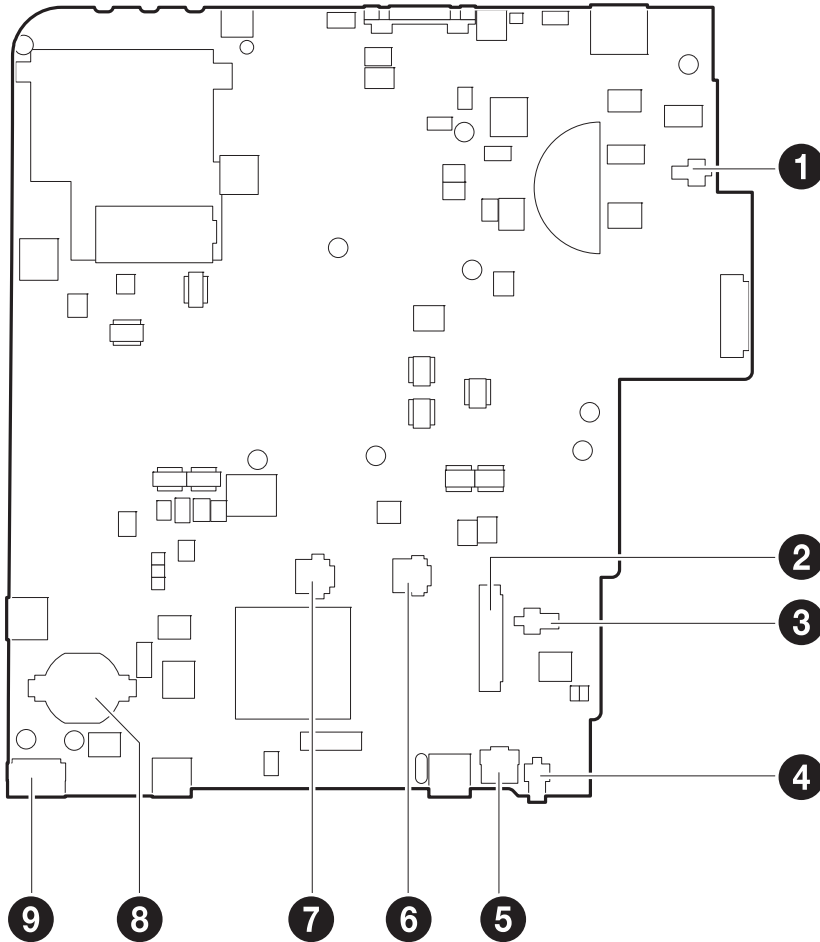

No.	Code	Connector
1	SPKR_L1	Left speaker cable connector
2	KB1	Keyboard cable connector
3	AMIC1	MIC cable connector
4	SPKR_R1	Right speaker cable connector
5	PSCN1	Volume button board cable connector
6	TPCN1	Touchpad board cable connector
7	FPCN1	Fingerprint cable connector
8	RTC1	RTC battery connector
9	USBCN1	USB cable connector

## Bottom View

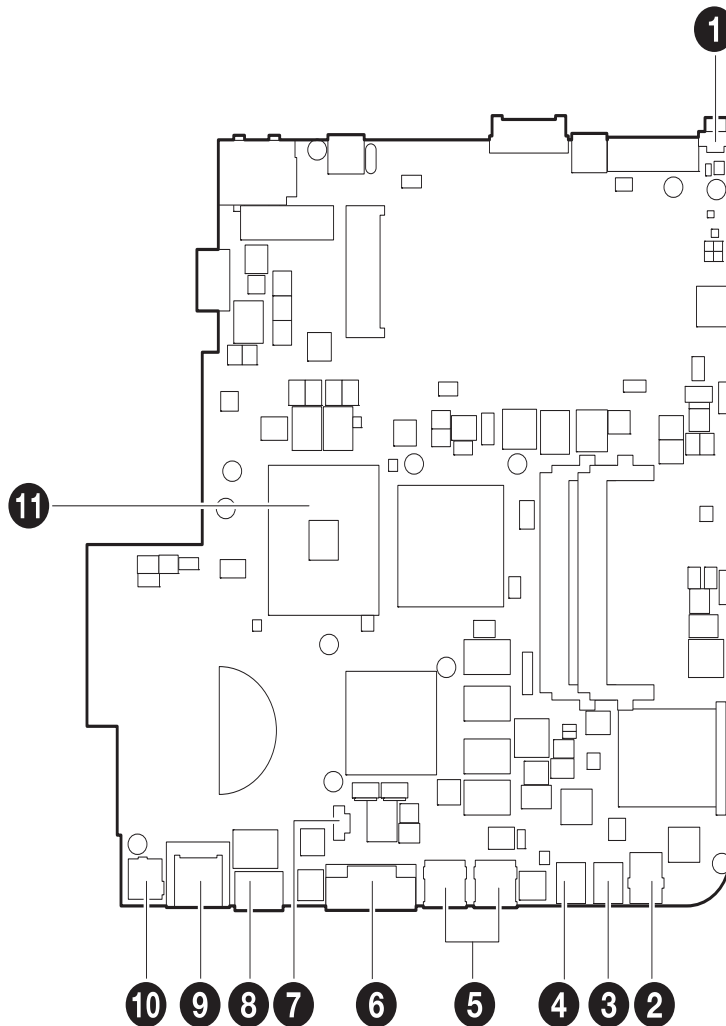

No.	Code	Connector
1	BT1	Bluetooth board cable connector
2	LOUT1	Headphone/speaker/line-out jack
3	MICIN1	Microphone-in jack
4	LIN1	Line-in port
5	USB1 & USB3	USB 2.0 ports
6	CRT1	VGA port
7	FAN1	Heatsink fan cable connector
8	HDMI1	HDMI port
9	RJ45	Ethernet port
10	DCIN1	DC-in port
11	CPU1	CPU socket

# Clearing Password Check and BIOS Recovery

This section provides the standard operating procedures for clearing the password and BIOS recovery for the system. There is one Hardware Open Gap on the main board for clearing the password check and one Hotkey for enabling BIOS Recovery.

## Clearing Password Check

### Hardware Open Gap Description

Hardware	Default Setting	Operation Description
Gap	Open (Normal)	Short (Clearing Password Check)

### Hardware Gap Position on the Main Board

Gap name in Aspire 5738DG/5738DZG Series and Aspire 5738G/5738ZG/5738Z/5738/5338 Series is G78.

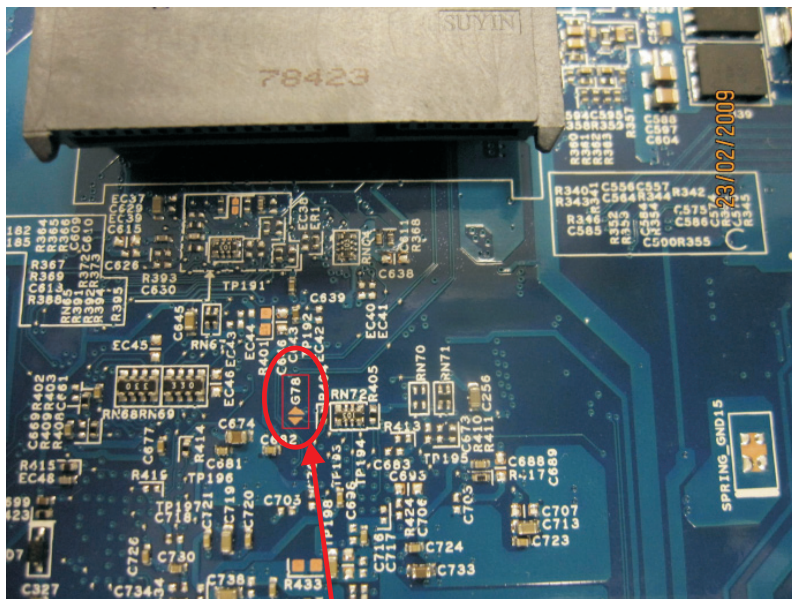

**G78**

Gap name in Aspire 5542G/5542/5242 and Aspire 5536/5536G/5236 Series is G106.

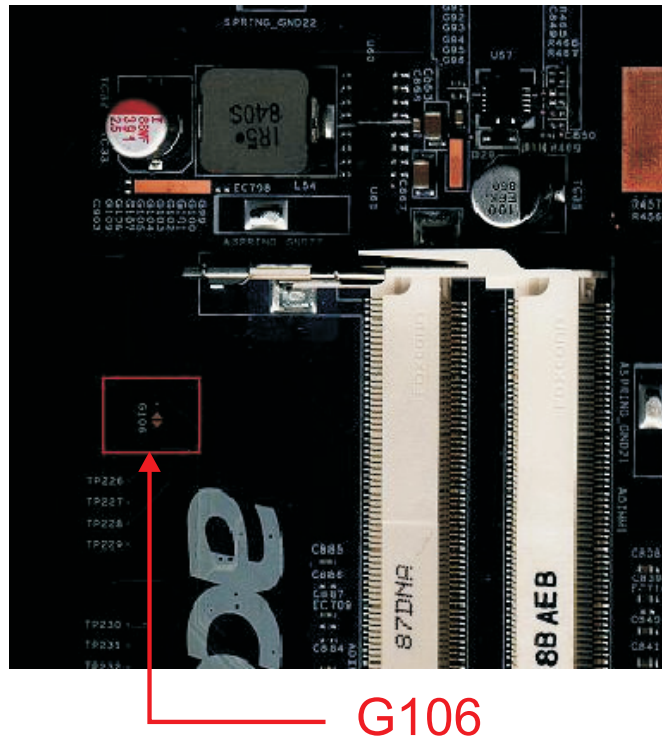

### Steps for Clearing BIOS Password Check

If the user sets the BIOS Password (Supervisor Password and/or User Password) for a security reason, the BIOS will ask for the password during system POST or when the system enters into the BIOS Setup menu. If it is necessary to bypass the password check, the user needs to short the hardware gap to clear the password by following these steps:

- Power off the system, and remove the HDD, AC adapter and battery from the computer.
- Open the back cover of the computer and look for the hardware gap on the main board as shown in the picture(s) above.
- Use an electric conductivity tool to short the two points of the hardware gap.
- Plug in the AC adapter while retaining the short condition on the hardware gap. Press the power button to turn on the computer until the BIOS POST routine is finished. Finally, remove the tool from the hardware gap.
- Restart the system. Press the F2 key to enter BIOS Setup menu.
- If there is no password request, the BIOS Password is cleared. Otherwise, repeat the steps above and try again.

**NOTE:** The steps are only for clearing the BIOS password (Supervisor Password and User Password).

---

## BIOS Recovery by Crisis Disk

### BIOS Recovery Boot Block:

BIOS Recovery Boot Block is a special block of the BIOS. It is used to boot up the system with minimum BIOS initialization. Users can enable this feature to restore the BIOS firmware to a successful one once the previous BIOS flashing process failed.

### BIOS Recovery Hotkey

The system provides a function hotkey: **Fn+Esc**, for enabling the BIOS Recovery process at system power-on during BIOS POST. To use this function, the AC adapter and the battery must be connected. If this function is enabled, the system will force the BIOS to enter a special BIOS block called Boot Block.

## Steps for BIOS Recovery by Crisis Disk

Before doing this, prepare a Crisis Disk (refer to the “Steps for Creating the Crisis Disk in Windows XP/Vista” section below) and keep it ready in hand.

Follow these steps for BIOS recovery:

1. Power off the system.
2. Connect a removable USB storage device containing the Crisis Disk to a USB port connected to the BIOS flash failed system.
3. Under power-off state, press and hold **Fn+Esc** and then press the power button. The system should be powered on with the Crisis BIOS Recovery process.
4. BIOS Boot Block starts to restore the BIOS code from the Crisis Disk to BIOS ROM on the failed system.
5. After the crisis flashing process is finished, the system will restart.

After the Crisis Recovery process is finished, the system should have a successful and workable BIOS after power on. The user can then update the latest BIOS version for this system using the regular BIOS flashing process.

## Creating the Crisis Disk in Windows

Follow these steps to create the Crisis Disk:

1. Prepare a removable USB storage device (size greater than 10MB). Note that all data on the USB storage device will be cleared during the creation of the Crisis Disk.
2. Set up another computer loaded with the same Windows operating system.

- Decompress the Crisis Package Source. Select **WINCRIS.EXE** and then select **Run as administrator** under Windows.

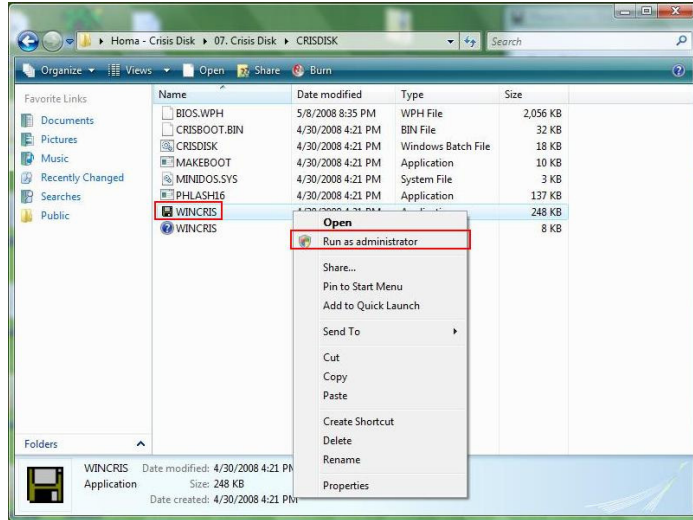

- Keep the default settings and then click on the **Start** button.

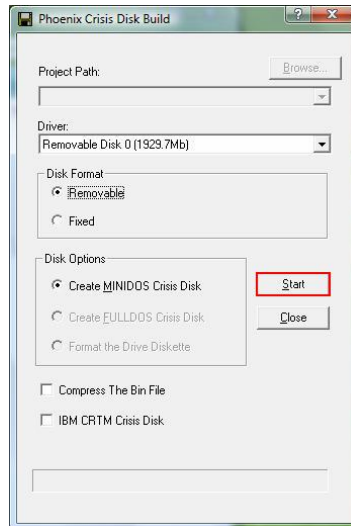

- When the pop-up warning dialog box appears, press **OK** to continue creating the Crisis Disk.

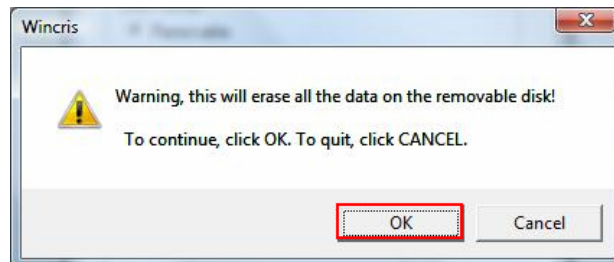

6. The Crisis Disk will be created after a few seconds.

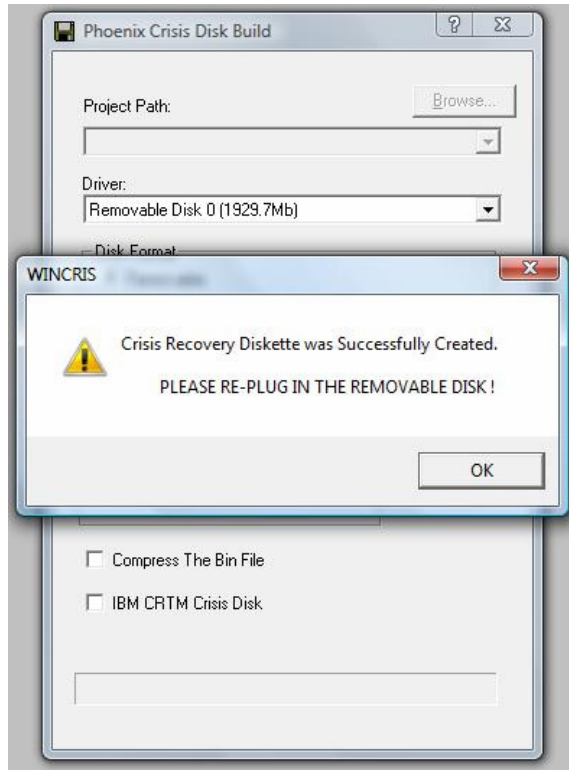

7. Press No if you do not want to create another Crisis Disk.

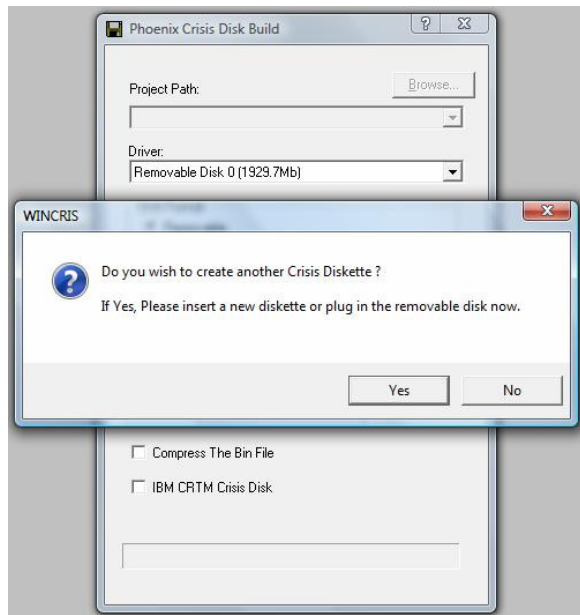

8. Reconnect the USB removable storage device and check if it contains the 3 files shown in the following figure.

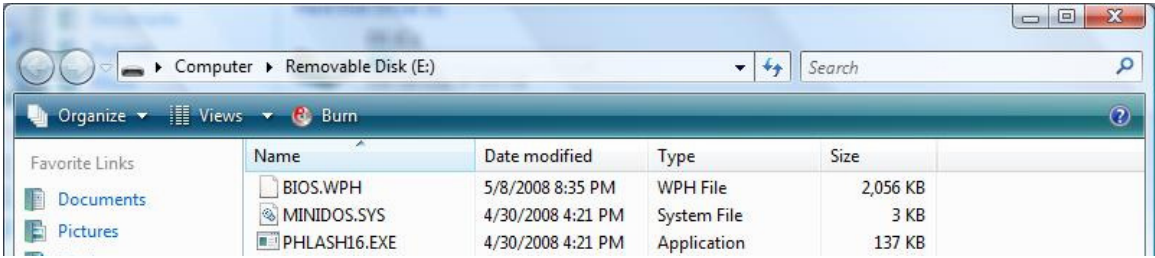



## FRU (Field Replaceable Unit) List

---

This chapter gives you the FRU (Field Replaceable Unit) listing in global configurations of Aspire 5738DG/5738DZG Series, Aspire 5738G/5738ZG/5738Z/5738/5338 Series, Aspire 5542G/5542/5242 Series and Aspire 5536/5536G/5236 Series. Refer to this chapter whenever ordering for parts to repair or for RMA (Return Merchandise Authorization).

Please note that WHEN ORDERING FRU PARTS, you should check the most up-to-date information available on your regional web or channel. For whatever reasons a part number change is made, it will not be noted on the printed Service Guide. For ACER AUTHORIZED SERVICE PROVIDERS, your Acer office may have a DIFFERENT part number code from those given in the FRU list of this printed Service Guide. You MUST use the local FRU list provided by your regional Acer office to order FRU parts for repair and service of customer machines.

NOTE: •To scrap or to return the defective parts, you should follow the local government ordinance or regulations on how to dispose it properly, or follow the rules set by your regional Acer office on how to return it.

# Exploded Diagram

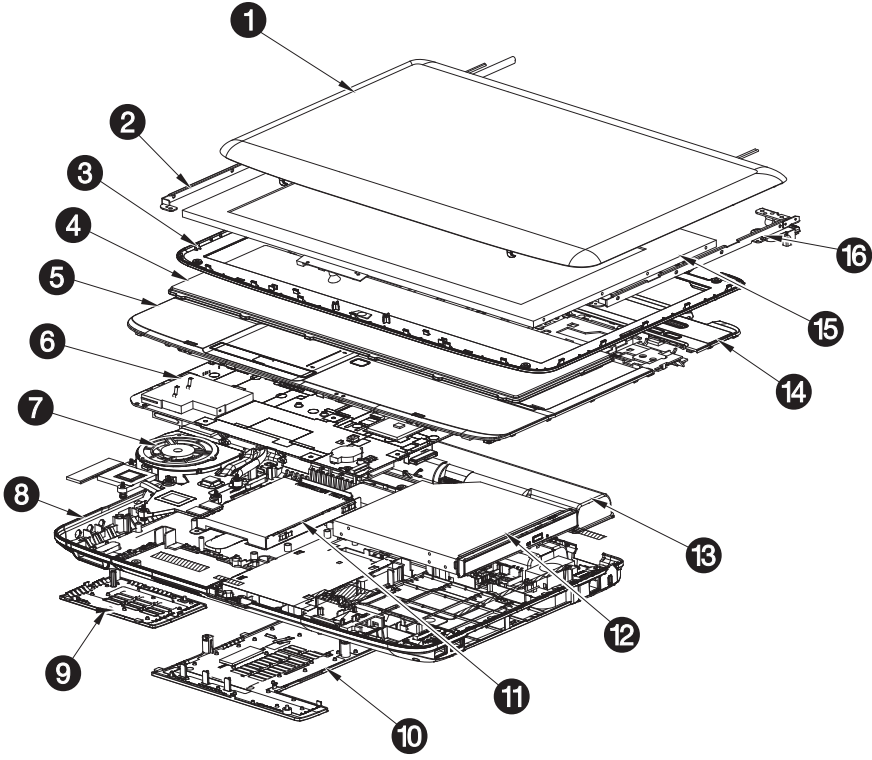

Item	Part Name	Q'ty	REF	Remark
1	Panel Assy Module	1	A0	
2	Hinge L Assy Module	1	A0	
3	Bezel Assy Module	1	A0	
4	Keyboard Module	1	A0	
5	65 U-case Assy module	1	A0	
6	MB Assy Module	1	A0	
7	Hsink Assy module	1	A0	
8	L-case Assy module	1	A0	
9	Dimm door Assy module	1	A0	
10	Hdd Door Assy module	1	A0	
11	65 HDD Assy module	1	A0	
12	65 ODD Assy Module	1	A0	
13	BTY Assy module	1	A0	
14	65 Middle Assy moudle	1	A0	
15	LCD Assy Moudle	1	A0	
16	Hinge R Assy Moudle	1	A0	

# FRU List

Aspire 5738DG/5738DZG Series, Aspire 5542G/5542/5242 Series, Aspire 5738G/5738ZG/5738Z/5738/5338 Series and Aspire 5536/5536G/5236 Series FRU List

1. ACER\_ASPIRE 5738DG M92XT512CBB 2V3\_JV50\_MV (NO: LX.PKD02.002)

Category	No	Part Name and Description	Acer Part No.
<b>ADAPTER</b> 	1	ADAPTER 65W 19V 3PIN HIPRO HP-A0652R3B 1LF LV5 LED LF YELLOW	AP.0650A.012
	1	ADAPTER 65W 19V 3PIN DELTA ADP-65JH DB A LV5 LED LF YELLOW	AP.06501.026
	1	ADAPTER 65W 19V 3PIN LITEON PA-1650-22AC LV5 LED LF YELLOW	AP.06503.024
<b>BATTERY</b> 	1	BATTERY PANASONIC AS-2007A LI-ION 3S2P PANASONIC 6 CELL 4400MAH MAIN COMMON PSS	BT.00605.020
	1	BATTERY SANYO AS-2007A LI-ION 3S2P SANYO 6 CELL 4400MAH MAIN COMMON NORMAL TYPE	BT.00603.041
	1	BATTERY SONY AS-2007A LI-ION 3S2P SONY 6 CELL 4400MAH MAIN COMMON NORMAL TYPE	BT.00604.024
	1	BATTERY SIMPLO AS-2007A LI-ION 3S2P PANASONIC 6 CELL 4400MAH MAIN COMMON PSS	BT.00607.015
	1	BATTERY SIMPLO AS-2007A LI-ION 3S2P LGC 6 CELL 4400MAH 2ND COMMON	BT.00607.019
	1	BATTERY SIMPLO AS-2007A LI-ION 3S2P SAMSUNG 6 CELL 4400MAH MAIN COMMON SDI 2.2MAH F TYPE	BT.00607.034
<b>BOARDS</b> 	1	BLUETOOTH BOARD FOXCONN BCM2045 V2 T60H928.11	BT.21100.005
	1	BLUETOOTH BOARD FOXCONN BRM 2046 BT.1 T60H928.33 F/W:861	BH.21100.004
	2	INVERTER BOARD YEC YNV-W15	19.AR501.001
	2	INVERTER BOARD FOXCONN T62I240.03 V.00	19.AR501.002
	2	INVERTER BOARD SUMIDA TWS-458-124 MS	19.AUA01.002
	2	INVERTER BOARD 17" DARFON VK.21189.408	19.TQ901.002
	1	LED BUTTON BOARD	55.PAT01.001
	2	MODEM BOARD LITEON CONEXANT -UNIZION 1.5_3.3V AUS B85247600G	FX.22500.021
	2	MODEM BOARD FOXCONN DELPHI-AM5 V2H 1.5_3.3V AUS T60M951.36	FX.22500.023
	1	TOUCHPAD BOARD SYNAPTICS TM00540-005	56.ATR01.001
	1	TOUCHPAD BOARD ALPS KGDF0038A	56.PAW01.001
	1	TOUCH PAD BUTTON BOARD	55.PAW01.003

Category	No	Part Name and Description	Acer Part No.
<b>BOARDS</b> 	1	USB BOARD	55.PAT01.002
		1	WIRELESS LAN BOARD 512AN_MMWG SHIRLEY PEAK 5100 MM#895361
	1	WIRELESS LAN BOARD 512AG_MMWG SHIRLEY PEAK 5100 MM#897004	KI.SPM01.005
<b>CABLES</b>	1	BLUETOOTH BOARD CABLE	50.ATR01.002
	1	BLUETOOTH BOARD CABLE	50.PAW01.004
	2	CCFL LCD/CAMERA CABLE	50.4CG13.012
	2	CCFL LCD/CAMERA CABLE	50.4CG13.002
	2	CCFL LCD/CAMERA CABLE	50.4CG13.022
	1	FINGER PRINT / TP BUTTON BOARD CABLE	50.PAW01.003
	2	LED BUTTON BOARD CABLE	50.4CG02.001
	2	LED BUTTON BOARD CABLE	50.4CG02.011
	2	MODEM CABLE	50.4CG04.011
	2	MODEM CABLE	50.4CG04.001
	1	POWER CORD 250V 3PIN EUR BK	27.T30V1.004
	1	POWER CABLE 16A 250V 3PIN EUR BK	27.01518.731
	1	POWER CORD 10A 250V ARGENTINE	27.01518.0U1
	1	POWER CORD 10A 125V US	27.T30V1.001
	1	POWER CORD 10A 125V 3PIN US BK	27.01518.641
	1	POWER CORD 7A 250V 2PIN KOREAN	27.01518.531
	1	POWER CORD 3A 250V 3PIN UK	27.01518.541
	1	POWER CORD 5A 250V 3PIN UK BK	27.03118.001
	1	POWER CORD 7A 125V 2PIN JAPAN	27.01518.551
	1	POWER CORD 10A 3PIN BK DENMARK	27.01518.561
	1	POWER CORD 10A 250V 3PIN DENMARK BK	27.01518.671
	1	POWER CORD 10A 250V 3PIN BK SOUTH AFRICA	27.01518.571
	1	POWER CORD 16A 250V SOUTH AFRICA BK	27.01518.681
	1	POWER CORD 10A 250V SWISS	27.01518.581
	1	POWER CORD 10A 250V 3PIN SWISS BK	27.01518.691
	1	POWER CORD 10A 250V 3PIN CHINA	27.01518.591
	1	POWER CORD 10A 250V 3PIN CHINA BK	27.01518.701
	1	POWER CORD 10A 250V 3PIN ITALY	27.01518.611
	1	POWER CORD 10A 250V 3PIN ITALY BK	27.01518.711
	1	POWER CORD 2.5A 250V AUSTRALIA	27.01518.621
	1	POWER CORD 2.5A 250V SOUTH AFRICA BK (INDIA)	27.01518.631
1	POWER CORD 10A 250V SOUTH AFRICA BK (INDIA)	27.01518.721	
1	POWER CORD 7A 125V 2PIN JAPAN BK	27.01518.661	
1	POWER CORD 250V 10A 3PIN ISRAEL	27.01518.761	

Category	No	Part Name and Description	Acer Part No.
<b>CABLES</b>	1	POWER CORD 2.5A 125V USA	27.01518.781
	1	POWER CORD 2.5A 125V 1.8M BLACK TAIWANESE	27.01518.A11
	1	POWER CORD 10A 250V 1.8M BRAZIL BLK	27.01518.A41
	1	POWER CORD ACA / ACNZ	27.03218.021
	1	POWER CORD 7.5A 250V 3P AUSTRALIA BK	27.03218.051
	1	POWER CORD 7A 125V 2PIN JAPAN	27.03518.161
	1	TOUCHPAD CABLE	50.PAW01.001
	1	USB BOARD CABLE	50.PAW01.002
<b>CAMERA</b> 	2	CAMERA 0.3M SUYIN CN0314-SN30-OV03-5	57.N4401.001
	2	CAMERA 0.3M CHICONY CNF701721004973L	57.W9401.001
<b>CASE/COVER/ BRACKET ASSEMBLY</b> 	2	3D FILM LCD BRACKET W/HINGE RIGHT	34.4CG34.001
	2	3D FILM LCD BRACKET W/HINGE LEFT	34.4CG35.001
	2	BLUE-RAY COMBO BEZEL	42.PAW01.005
	2	DVD-RW SUPER-MULTI BEZEL	42.PAW01.004
	2	HDD BRACKET	33.PAW01.003
	2	LCD BEZEL 15.6" W/CAMERA HOLE	60.4CG60.001
	2	LCD COVER IMR 15.6" BLUE W/ANTENNA*2 & LOGO NONE 3G FOR MMW	60.4CG68.001
	1	LOWER CASE W/MODEM CABLE&SPEAKER	60.PAW01.001
	1	MIDDLE COVER W/BLUETOOTH BUTTON WITH BLUE LIGHT NONE 3G BUTTON	42.PAW01.001
	2	OPTICAL BRACKET	33.PAW01.002

Category	No	Part Name and Description	Acer Part No.
<b>CASE/COVER/ BRACKET ASSEMBLY</b>  	1	SD DUMMY CARD	42.TKJ01.001
	1	TOUCHPAD BRACKET	33.PAW01.001
	1	UNITLOAD COVER	42.PAW01.002
	1	UPPER CASE BLUE W/LED BUTTON BOARD CABLE&MICROPHONE&SPEAKER W/O FINGER PRINT HOLE	60.PAW01.002
	1	WIRELESS LAN COVER	42.PAW01.003
	<b>COMBO MODULE</b>  	1	BLU-RAY COMBO MODULE 4X SATA FOR WINDOWS7
1		BLU-RAY COMBO MODULE 4X SATA	6M.PAW01.001
2		ODD PIONEER BD COMBO 12.7 SATA DL 4X BDC- TD01RS LF W/O BEZEL SATA	KO.00405.002
2		ODD HLDS BD COMBO 12.7MM TRAY DL 4X CT10 LF W/ O BEZEL SATA	KO.0040D.002
2		ODD PLDS BD COMBO 12.7MM TRAY DL 4X DS-4E1S LF W/O BEZEL SATA	KO.0040F.001
2		ODD PLDS BD COMBO 12.7MM TRAY DL 4X DS-4E1S LF W/O BEZEL SATA FOR WINDOWS7	KO.0040F.003
<b>CPU/PROCESSOR</b>  	1	CPU INTEL CORE2DUAL T6600 2.2G 2M 800 35W R-0	KC.66001.DTP
	1	CPU INTEL CORE2DUAL T6400 2.0G 3M 800 35W R-0	KC.64001.DTP
	1	CPU INTEL CORE2DUAL T6500 PGA 2.1G 2M 800 R-0	KC.65001.DTP
	1	CPU INTEL CORE2DUAL P7350 PGA 2.0G 3M 1066 25W	KC.73501.DPP
	1	CPU INTEL CORE2DUAL P7450 2.13G 3M 1066 TJ NOV7	KC.74501.DPP
	1	CPU INTEL CORE2DUAL P7550 PGA 2.26G 3M 1066 R-0	KC.75501.DPP
	1	CPU INTEL CORE2DUAL P8400 PGA 2.26G 3M 1066 25W	KC.84001.DPP
	1	CPU INTEL CORE2DUAL P8600 PGA 2.4G 1066 25W 3M	KC.86001.DPP
	1	CPU INTEL CORE2DUAL P8700 2.53G 3M 1066 25W R-0	KC.87R01.DPP
	1	CPU INTEL CORE2DUAL P8800 PGA 2.66G 3M 1066 25W R-0	KC.88R01.DPP
	1	CPU INTEL CORE2DUAL PENRYN T9550 2.66G 6M 1066 35W E-0	KC.95501.DTP
	1	CPU INTEL CORE2DUAL P7450 2.13G 3M R-0 TJ	KC.74501.DPR
<b>DVD-RW DRIVE</b>	1	DVD-RW SUPER-MULTI MODULE 8X SATA	6M.PAW01.002
	2	ODD HLDS SUPER-MULTI DRIVE 12.7MM TRAY DL 8X GT20N LF W/O BEZEL SATA	KU.0080D.040
	2	ODD HLDS SUPER-MULTI DRIVE 12.7MM TRAY DL 8X GT30N LF W/O BEZEL SATA FOR HF+WINDOWS7	KU.0080D.048

Category	No	Part Name and Description	Acer Part No.
<b>DVD-RW DRIVE</b>	2	ODD HLDS SUPER-MULTI DRIVE 8X 12.7MM TRAY DL GT20N LF W/O BEZEL CP03 SATA FOR WINDOWS7	KU.0080D.051
	2	ODD PANASONIC SUPER-MULTI DRIVE 12.7MM TRAY DL 8X UJ890A LF W/O BEZEL SATA HF+WINDOWS 7	KU.00807.070
	2	ODD PLDS SUPER-MULTI DRIVE 12.7MM TRAY DL 8X SATA DS-8A3S LF W/O BEZEL	KU.0080F.004
	2	ODD PLDS SUPER-MULTI DRIVE 12.7MM TRAY DL 8X DS-8A4SH LF W/O BEZEL SATA FOR HF+WINDOWS7	KU.0080F.006
	2	ODD PLDS SUPER-MULTI DRIVE 12.7MM TRAY DL 8X DS-8A3S LF W/O BEZEL SATA FOR WINDOWS7	KU.0080F.008
	2	ODD SONY SUPER-MULTI DRIVE 12.7MM TRAY DL 8X AD-7580S LF W/O BEZEL SATA	KU.0080E.017
	2	ODD SONY SUPER-MULTI DRIVE 12.7MM TRAY DL 8X AD-7590S LF W/O BEZEL SATA	KU.0080E.025
	2	ODD SONY SUPER-MULTI DRIVE 12.7MM TRAY DL 8X AD-7585H LF W/O BEZEL SATA FOR HF+WINDOWS7	KU.0080E.027
	2	ODD SONY SUPER-MULTI DRIVE 12.7MM TRAY DL 8X AD-7580S LF W/O BEZEL FW FX20 SATA FOR WINDOWS7	KU.0080E.030
	1	DVD-RW SUPER-MULTI MODULE 8X SATA FOR WINDOWS7	
	2	ODD TOSHIBA SUPER-MULTI DRIVE 12.7MM TRAY DL 8X SATA TS-L633B LF W/O BEZEL	KU.00801.030
	2	ODD TOSHIBA SUPER-MULTI DRIVE 12.7MM TRAY DL 8X TS-L633C LF W/O BEZEL SATA FOR HF+WINDOWS7	KU.00801.035
	2	ODD TOSHIBA SUPER-MULTI DRIVE 12.7MM TRAY DL 8X TS-L633B LF W/O BEZEL AC02 SATA FOR WINDOWS7	KU.00801.036
	<b>HDD/HARD DISK DRIVE</b>	1	HDD MODULE 160GB 5400RPM SATA
2		HDD 160GB 5400RPM 2.5" SATA HGST HTS543216L9A300 F/W:C30C	KH.16007.019
2		HDD 160GB 5400RPM 2.5" SATA WD WD1600BEVT-22ZCT0 FW:11.01A11	KH.16008.022
1		HDD MODULE 250GB 5400RPM SATA	
2		HDD 2.5" 5400RPM 250GB SEAGATE ST9250315AS WYATT SATA LF F/W:0001SDM1	KH.25001.016
2		HDD 250GB 5400RPM SATA HGST HTS543225L9A300 LF F/W:C40C	KH.25007.013
2		HDD 250GB 5400RPM SATA HGST HTS545025B9A300 PANTHER-B LF	KH.25007.015
2		HDD 250GB 5400RPM 2.5" SATA HGST HTS545025B9A300 PANTHER B LF F/W:C60F DISK IMBALANCE CRITERIA = 0.014G-CM	KH.25007.016
2		HDD 250GB 5400RPM SATA WD WD2500BEVT-22ZCT0 F/W:11.01A11	KH.25008.021
1		HDD MODULE 320GB 5400RPM SATA	
2		HDD 320GB 5400RPM SATA HGST HTS545032B9A300 PANTHER B LF	KH.32007.007
2		HDD 320GB 5400RPM SATA SEAGATE ST9320320AS F/W:2010	KH.32001.008
2		HDD 320GB 5400RPM SATA HGST HTS543232L9A300 F/W:C30C	KH.32007.004



Category	No	Part Name and Description	Acer Part No.
<b>HDD/HARD DISK DRIVE</b>	2	HDD 320GB 5400RPM 2.5" SATA HGST HTS545032B9A300 PANTHER B LF F/W:C60F DISK IMBALANCE CRITERIA = 0.014G-CM	KH.32007.008
	2	HDD 320GB 5400RPM SATA WD WD3200BEVT-22ZCT0 ML125 F/W:01.01A01	KH.32008.013
	1	HDD MODULE 500GB 5400RPM SATA	
	2	HDD 500GB 5400RPM SEAGATE ST9500325AS SATA LF F/W:0001SDM1	KH.50001.011
	2	HDD 500GB 5400RPM HGST SATA HTS545050B9A300 PANTHER B LF	KH.50007.009
	2	HDD HGST 2.5" 5400RPM 500GB HTS545050B9A300 PANTHER B SATA LF F/W:C60F DISK IMBALANCE CRITERIA = 0.014G-CM	KH.50007.010
	2	HDD 500GB 5400RPM WD SATA WD5000BEVT-22ZAT0 F/W:01.01A01	KH.50008.013
<b>HEATSINK</b> 	1	CPU HEATSINK DISCRETE DDR2 W/FAN	60.PEY01.001
<b>KEYBOARD</b> 	1	KEYBOARD 103KEYS NSK-ALA0J AC7T JV50 INTERNAL 17 STANDARD BLACK TEXTURE RUSSIAN	KB.1170A.048
	1	KEYBOARD 104KEYS NSK-ALA0J AC7T JV50 INTERNAL 17 STANDARD BLACK TEXTURE GERMAN	KB.1170A.040
	1	KEYBOARD 104KEYS NSK-ALA0J AC7T JV50 INTERNAL 17 STANDARD BLACK TEXTURE UK	KB.1170A.055
	1	KEYBOARD 104KEYS NSK-ALA0J AC7T JV50 INTERNAL 17 STANDARD BLACK TEXTURE SWISS	KB.1170A.052
	1	KEYBOARD 103KEYS NSK-ALA0J AC7T JV50 INTERNAL 17 STANDARD BLACK TEXTURE TAIWAN	KB.1170A.036
	1	KEYBOARD 103KEYS NSK-ALA0J AC7T JV50 INTERNAL 17 STANDARD BLACK TEXTURE THAILAND	KB.1170A.053
	1	KEYBOARD 104KEYS NSK-ALA0J AC7T JV50 INTERNAL 17 STANDARD BLACK TEXTURE PORTUGAL	KB.1170A.047
	1	KEYBOARD 103KEYS NSK-ALA0J AC7T JV50 INTERNAL 17 STANDARD BLACK TEXTURE ARABIC	KB.1170A.032
	1	KEYBOARD 104KEYS NSK-ALA0J AC7T JV50 INTERNAL 17 STANDARD BLACK TEXTURE DANISH	KB.1170A.037
	1	KEYBOARD 104KEYS NSK-ALA0J AC7T JV50 INTERNAL 17 STANDARD BLACK TEXTURE ITALIAN	KB.1170A.043
	1	KEYBOARD 104KEYS NSK-ALA0J AC7T JV50 INTERNAL 17 STANDARD BLACK TEXTURE FRENCH	KB.1170A.039
	1	KEYBOARD 103KEYS NSK-ALA0J AC7T JV50 INTERNAL 17 STANDARD BLACK TEXTURE HEBREW	KB.1170A.057
	1	KEYBOARD 107KEYS NSK-ALA0J AC7T JV50 INTERNAL 17 STANDARD BLACK TEXTURE JAPANESE	KB.1170A.044
	1	KEYBOARD 103KEYS NSK-ALA0J AC7T JV50 INTERNAL 17 STANDARD BLACK TEXTURE GREEK	KB.1170A.041
	1	KEYBOARD 104KEYS NSK-ALA0J AC7T JV50 INTERNAL 17 STANDARD BLACK TEXTURE NORWEGIAN	KB.1170A.046
	1	KEYBOARD 104KEYS NSK-ALA0J AC7T JV50 INTERNAL 17 STANDARD BLACK TEXTURE HUNGARIAN	KB.1170A.042
	1	KEYBOARD 104KEYS NSK-ALA0J AC7T JV50 INTERNAL 17 STANDARD BLACK TEXTURE SPANISH	KB.1170A.050

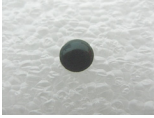

Category	No	Part Name and Description	Acer Part No.
<b>KEYBOARD</b>	1	KEYBOARD 104KEYS NSK-ALA0J AC7T JV50 INTERNAL 17 STANDARD BLACK TEXTURE TURKISH	KB.I170A.054
	1	KEYBOARD 104KEYS NSK-ALA0J AC7T JV50 INTERNAL 17 STANDARD BLACK TEXTURE SWEDISH	KB.I170A.051
	1	KEYBOARD 104KEYS NSK-ALA0J AC7T JV50 INTERNAL 17 STANDARD BLACK TEXTURE CZECH/SLOVAK	KB.I170A.035
	1	KEYBOARD 104KEYS NSK-ALA0J AC7T JV50 INTERNAL 17 STANDARD BLACK TEXTURE BELGIAN	KB.I170A.033
	1	KEYBOARD 104KEYS NSK-ALA0J AC7T JV50 INTERNAL 17 STANDARD BLACK TEXTURE BRAZILIAN PORTUGUESE	KB.I170A.034
	1	KEYBOARD 103KEYS NSK-ALA0J AC7T JV50 INTERNAL 17 STANDARD BLACK TEXTURE US-INTERNATIONAL	KB.I170A.056
	1	KEYBOARD 104KEYS NSK-ALA0J AC7T JV50 INTERNAL 17 STANDARD BLACK TEXTURE SLOVE	KB.I170A.049
	1	KEYBOARD 104KEYS NSK-ALA0J AC7T JV50 INTERNAL 17 STANDARD BLACK TEXTURE NORDIC	KB.I170A.045
	1	KEYBOARD 104KEYS NSK-ALA0J AC7T JV50 INTERNAL 17 STANDARD BLACK TEXTURE FRENCH ARABIC	KB.I170A.038
	1	KEYBOARD 104KEYS NSK-ALA0J AC7T JV50 INTERNAL 17 STANDARD BLACK TEXTURE FRENCH CANADIAN	KB.I170A.058
<b>LCD</b> 	1	3D CCFL LCD MODULE 15.6" WXGA GLARE BLUE W/ ANTENNA*2&CAMERA (NONE 3G) FOR MMW	
	2	3D CCFL LCD MODULE 15.6" WXGA GLARE ARISAWA 09WS156CMC LF 220NIT 8MS	56.0719A.001
<b>MAINBOARD</b> 	1	MAINBOARD JV50_MV DDR2 DIS 3D M92XT AMD PM45 ICH9M VRAM DDRIII 800 1GB LF W/RTC BATTERY&MODEM BOARD FOR NONE 3G	55.4CG01.241G
	1	MAINBOARD JV50_MV DDR2 DIS 3D M92XT AMD PM45 ICH9M VRAM DDRIII 800 1GB LF W/RTC BATTERY&MODEM BOARD FOR NONE 3G	55.4CG01.251G
<b>MEMORY</b> 	1	SODIMM 1GB DDRII667 HYNIX HYMP112S64CP6-Y5 LF	KN.1GB0G.012
	1	SODIMM 1GB DDRII667 SAMSUNG M470T2864QZ3-CE6 LF	KN.1GB0B.016
	1	SODIMM 1GB DDRII 800 SAMSUNG M470T2864EH3-CF7 LF 64*16 0.055UM	KN.1GB0B.033
	1	SODIMM 2GB DDRII 800 SAMSUNG M470T5663EH3-CF7 LF 128*8 0.055UM	KN.2GB0B.018
	1	SODIMM 2GB DDRII667 SAMSUNG M470T5663QZ3-CE6 LF	KN.2GB0B.003
	1	SODIMM 2GB DDRII667 HYNIX HYMP125S64CP8-Y5 LF	KN.2GB0G.004
<b>MICROPHONE</b>	2	MICROPHONE	23.42231.001
	2	MICROPHONE	23.40544.001
	2	MICROPHONE	23.42238.001
	2	MICROPHONE	23.42239.001
<b>MISCELLANEOUS</b> 	1	3D GLASSES KUJIEN WTC001 FOR CLIP TYPE	90.4DI28.002
	1	3D GLASSES KUJIEN WT090A FOR WESTERN TYPE	90.4DI28.006
	1	3D GLASSES KUJIEN WT0911 FOR EASTERN TYPE	90.4DI28.005

Category	No	Part Name and Description	Acer Part No.
<b>MISCELLANEOUS</b> 	1	LCD SCREW RUBBER	47.AU401.001
	1	NAME PLATE AS5738DG	40.4CG58.001
<b>SCREWS</b>	1	SCREW M2.5X6	86.00E12.536
	1	SCREW M2X4	86.00E13.524
	1	SCREW M2.5*L8 NYLOK CR3+	86.00E34.738
	1	SCREW M2.5X10	86.1Z533.100
	1	SCREW M2X3	86.9A522.3R0
	1	SCREW M2*4 WAFER NI	86.9A552.4R0
	1	SCREW MACH WAFER M3*L4 NI	86.9A554.4R0
<b>SPEAKER</b>	2	SPEAKER ON LOWER CASE	23.PAW01.001
	2	SPEAKER ON UPPER CASE	23.PAW01.002

2. ACER\_ASPIRE 5738DG M92XT512CFBB 2V3\_JV50\_MV (NO: LX.PKE02.002/11 )

Category	No.	Part Name & Description	Acer Part No.
<b>ADAPTER</b> 	1	ADAPTER 65W 19V 3PIN HIPRO HP-A0652R3B 1LF LV5 LED LF YELLOW	AP.0650A.012
	1	ADAPTER 65W 19V 3PIN DELTA ADP-65JH DB A LV5 LED LF YELLOW	AP.06501.026
	1	ADAPTER 65W 19V 3PIN LITEON PA-1650-22AC LV5 LED LF YELLOW	AP.06503.024
<b>BATTERY</b> 	1	BATTERY PANASONIC AS-2007A LI-ION 3S2P PANASONIC 6 CELL 4400MAH MAIN COMMON PSS	BT.00605.020
	1	BATTERY SANYO AS-2007A LI-ION 3S2P SANYO 6 CELL 4400MAH MAIN COMMON NORMAL TYPE	BT.00603.041
	1	BATTERY SONY AS-2007A LI-ION 3S2P SONY 6 CELL 4400MAH MAIN COMMON NORMAL TYPE	BT.00604.024
	1	BATTERY SIMPLO AS-2007A LI-ION 3S2P PANASONIC 6 CELL 4400MAH MAIN COMMON PSS	BT.00607.015
	1	BATTERY SIMPLO AS-2007A LI-ION 3S2P LGC 6 CELL 4400MAH 2ND COMMON	BT.00607.019
	1	BATTERY SIMPLO AS-2007A LI-ION 3S2P SAMSUNG 6 CELL 4400MAH MAIN COMMON SDI 2.2MAH F TYPE	BT.00607.034
<b>BOARDS</b> 	1	BLUETOOTH BOARD FOXCONN BRM 2046 BT2.1 T60H928.33 F/W:861	BH.21100.004
	1	BLUETOOTH BOARD FOXCONN BCM2045 V2 T60H928.11	BT.21100.005
	1	FINGER PRINT BASE BOARD	55.PAX01.001
	1	FINGER PRINT SENSOR BOARD	55.PAX01.002

Category	No.	Part Name & Description	Acer Part No.
<b>BOARDS</b> 	2	INVERTER BOARD YEC YNV-W15	19.AR501.001
	2	INVERTER BOARD FOXCONN T62I240.03 V.00	19.AR501.002
	2	INVERTER BOARD SUMIDA TWS-458-124 MS	19.AUA01.002
	2	INVERTER BOARD 17" DARFON VK.21189.408	19.TQ901.002
	1	LED BUTTON BOARD	55.PAT01.001
	2	MODEM BOARD FOXCONN DELPHI-AM5 V2H 1.5_3.3V AUS T60M951.36	FX.22500.023
	2	MODEM BOARD LITEON CONEXANT -UNIZION 1.5_3.3V AUS B85247600G	FX.22500.021
	1	TOUCHPAD BOARD SYNAPTICS TM00540-005	56.ATR01.001
	1	TOUCHPAD BOARD ALPS KGDF0038A	56.PAW01.001
	1	USB BOARD	55.PAT01.002
	1	WIRELESS LAN BOARD 512AN_MMWG SHIRLEY PEAK 5100 MM#895361	KI.SPM01.003
	1	WIRELESS LAN BOARD 512AG_MMWG SHIRLEY PEAK 5100 MM#897004	KI.SPM01.005
<b>CABLES</b> 	1	BLUETOOTH BOARD CABLE	50.PAW01.004
	1	BLUETOOTH BOARD CABLE	50.ATR01.002
	2	CCFL LCD/CAMERA CABLE	50.4CG13.002
	2	CCFL LCD/CAMERA CABLE	50.4CG13.012
	2	CCFL LCD/CAMERA CABLE	50.4CG13.022
	1	FINGER PRINT / TP BUTTON BOARD CABLE	50.PAW01.003
	2	LED BUTTON BOARD CABLE	50.4CG02.001
	2	LED BUTTON BOARD CABLE	50.4CG02.011
	2	MODEM CABLE	50.4CG04.011
	2	MODEM CABLE	50.4CG04.001

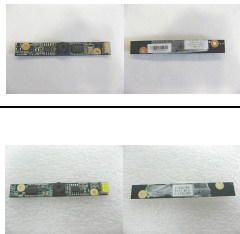

Category	No.	Part Name & Description	Acer Part No.
<b>CABLES</b> 	1	POWER CORD 250V 3PIN EUR BK	27.T30V1.004
	1	POWER CABLE 16A 250V 3PIN EUR BK	27.01518.731
	1	POWER CORD 10A 250V ARGENTINE	27.01518.0U1
	1	POWER CORD 10A 125V US	27.T30V1.001
	1	POWER CORD 10A 125V 3PIN US BK	27.01518.641
	1	POWER CORD 7A 250V 2PIN KOREAN	27.01518.531
	1	POWER CORD 3A 250V 3PIN UK	27.01518.541
	1	POWER CORD 5A 250V 3PIN UK BK	27.03118.001
	1	POWER CORD 7A 125V 2PIN JAPAN	27.01518.551
	1	POWER CORD 10A 3PIN BK DENMARK	27.01518.561
	1	POWER CORD 10A 250V 3PIN DENMARK BK	27.01518.671
	1	POWER CORD 10A 250V 3PIN BK SOUTH AFRICA	27.01518.571
	1	POWER CORD 16A 250V SOUTH AFRICA BK	27.01518.681
	1	POWER CORD 10A 250V SWISS	27.01518.581
	1	POWER CORD 10A 250V 3PIN SWISS BK	27.01518.691
	1	POWER CORD 10A 250V 3PIN CHINA	27.01518.591
	1	POWER CORD 10A 250V 3PIN CHINA BK	27.01518.701
	1	POWER CORD 10A 250V 3PIN ITALY	27.01518.611
	1	POWER CORD 10A 250V 3PIN ITALY BK	27.01518.711
	1	POWER CORD 2.5A 250V AUSTRALIA	27.01518.621
	1	POWER CORD 2.5A 250V SOUTH AFRICA BK (INDIA)	27.01518.631
	1	POWER CORD 10A 250V SOUTH AFRICA BK (INDIA)	27.01518.721
	1	POWER CORD 7A 125V 2PIN JAPAN BK	27.01518.661
	1	POWER CORD 250V 10A 3PIN ISRAEL	27.01518.761
	1	POWER CORD 2.5A 125V USA	27.01518.781
	1	POWER CORD 2.5A 125V 1.8M BLACK TAIWANESE	27.01518.A11
	1	POWER CORD 10A 250V 1.8M BRAZIL BLK	27.01518.A41
	1	POWER CORD ACA / ACNZ	27.03218.021
	1	POWER CORD 7.5A 250V 3P AUSTRALIA BK	27.03218.051
	1	POWER CODE 7A 125V 2PIN JAPAN	27.03518.161
	1	TOUCHPAD CABLE	50.PAW01.001
	1	TOUCHPAD CABLE	50.PAW01.001
	1	USB BOARD CABLE	50.PAW01.002
1	USB BOARD CABLE	50.PAW01.002	
1	USB BOARD CABLE	50.PAW01.002	
<b>CAMERA</b> 	2	CAMERA 0.3M SUYIN CN0314-SN30-OV03-5	57.N4401.001
	2	CAMERA 0.3M CHICONY CNF701721004973L	57.W9401.001

Category	No.	Part Name & Description	Acer Part No.
<b>CASE/COVER/ BRACKET ASSEMBLY</b> 	2	3D FILM LCD BRACKET W/HINGE RIGHT	34.4CG34.001
	2	3D FILM LCD BRACKET W/HINGE LEFT	34.4CG35.001
	2	BLUE-RAY COMBO BEZEL	42.PAW01.005
	2	DVD-RW SUPER-MULTI BEZEL	42.PAW01.004
	2	HDD BRACKET	33.PAW01.003
	2	LCD BEZEL 15.6" W/CAMERA HOLE	60.4CG60.001
	2	LCD COVER IMR 15.6" BLUE W/ANTENNA*2 & LOGO NONE 3G FOR MMW	60.4CG68.001
	1	LOWER CASE W/MODEM CABLE&SPEAKER	60.PAW01.001
	1	MIDDLE COVER W/BLUETOOTH BUTTON WITH BLUE LIGHT NONE 3G BUTTON	42.PAW01.001
	2	OPTICAL BRACKET	33.PAW01.002
	1	SD DUMMY CARD	42.TKJ01.001
	1	TOUCHPAD BRACKET	33.PAW01.001
	1	UNITLOAD COVER	42.PAW01.002
	1	UPPER CASE BLUE W/LED BUTTON BOARD CABLE&MICROPHONE&SPEAKER&FINGER PRINT HOLE	60.PAX01.001

Category	No.	Part Name & Description	Acer Part No.	
<b>CASE/COVER/ BRACKET ASSEMBLY</b> 	1	WIRELESS LAN COVER	42.PAW01.003	
	1	BLU-RAY COMBO MODULE 4X SATA FOR WINDOWS7		
<b>COMBO MODULE</b>	1	BLU-RAY COMBO MODULE 4X SATA	6M.PAW01.001	
	2	ODD PIONEER BD COMBO 12.7 SATA DL 4X BDC-TD01RS LF W/O BEZEL SATA	KO.00405.002	
	2	ODD HLDS BD COMBO 12.7MM TRAY DL 4X CT10 LF W/O BEZEL SATA	KO.0040D.002	
	2	ODD PLDS BD COMBO 12.7MM TRAY DL 4X DS-4E1S LF W/O BEZEL SATA	KO.0040F.001	
	2	ODD PLDS BD COMBO 12.7MM TRAY DL 4X DS-4E1S LF W/O BEZEL SATA FOR WINDOWS7	KO.0040F.003	
	2	ODD PIONEER BD COMBO 12.7MM TRAY DL 4X SATA BDC-TD01RS LF W/O BEZEL FOR WINDOWS7	KO.00405.003	
	1	CPU INTEL CORE2DUAL P7450 2.13G 3M 1066 TJ NOV T	KC.74501.DPP	
<b>CPU/PROCESSOR</b> 	1	CPU INTEL CORE2DUAL P7550 PGA 2.26G 3M 1066 R-0	KC.75501.DPP	
	1	CPU INTEL CORE2DUAL T6600 2.2G 2M 800 35W R-0	KC.66001.DTP	
	1	CPU INTEL CORE2DUAL T6400 2.0G 3M 800 35W R-0	KC.64001.DTP	
	1	CPU INTEL CORE2DUAL T6500 PGA 2.1G 2M 800 R-0	KC.65001.DTP	
	1	CPU INTEL CORE2DUAL P7350 PGA 2.0G 3M 1066 25W	KC.73501.DPP	
	1	CPU INTEL CORE2DUAL P8400 PGA 2.26G 3M 1066 25W	KC.84001.DPP	
	1	CPU INTEL CORE2DUAL P8600 PGA 2.4G 1066 25W 3M	KC.86001.DPP	
	1	CPU INTEL CORE2DUAL P8700 2.53G 3M 1066 25W R-0	KC.87R01.DPP	
	1	CPU INTEL CORE2DUAL P8800 PGA 2.66G 3M 1066 25W R-0	KC.88R01.DPP	
	1	CPU INTEL CORE2DUAL PENRYN T9550 2.66G 6M 1066 35W E-0	KC.95501.DTP	
	1	CPU INTEL CORE2DUAL P7450 2.13G 3M R-0 TJ	KC.74501.DPR	
	<b>DVD-RW DRIVE</b>	1	DVD-RW SUPER-MULTI MODULE 8X SATA	6M.PAW01.002
		2	ODD TOSHIBA SUPER-MULTI DRIVE 12.7MM TRAY DL 8X SATA TS-L633B LF W/O BEZEL	KU.00801.030
2		ODD HLDS SUPER-MULTI DRIVE 12.7MM TRAY DL 8X GT20N LF W/O BEZEL SATA	KU.0080D.040	
2		ODD SONY SUPER-MULTI DRIVE 12.7MM TRAY DL 8X AD-7580S LF W/O BEZEL SATA	KU.0080E.017	
2		ODD SONY SUPER-MULTI DRIVE 12.7MM TRAY DL 8X AD-7590S LF W/O BEZEL SATA	KU.0080E.025	
2		ODD PLDS SUPER-MULTI DRIVE 12.7MM TRAY DL 8X SATA DS-8A3S LF W/O BEZEL	KU.0080F.004	
1		DVD-RW SUPER-MULTI MODULE 8X SATA FOR WINDOWS7		
2		ODD HLDS SUPER-MULTI DRIVE 12.7MM TRAY DL 8X GT30N LF W/O BEZEL SATA FOR HF+WINDOWS7	KU.0080D.048	
2		ODD TOSHIBA SUPER-MULTI DRIVE 12.7MM TRAY DL 8X TS-L633C LF W/O BEZEL SATA FOR HF+WINDOWS7	KU.00801.035	
2		ODD TOSHIBA SUPER-MULTI DRIVE 12.7MM TRAY DL 8X TS-L633B LF W/O BEZEL AC02 SATA FOR WINDOWS7	KU.00801.036	

Category	No.	Part Name & Description	Acer Part No.
<b>DVD-RW DRIVE</b>	2	ODD PANASONIC SUPER-MULTI DRIVE 12.7MM TRAY DL 8X UJ890A LF W/O BEZEL SATA HF+WINDOWS 7	KU.00807.070
	2	ODD HLDS SUPER-MULTI DRIVE 8X 12.7MM TRAY DL GT20N LF W/O BEZEL CP03 SATA FOR WINDOWS7	KU.0080D.051
	2	ODD SONY SUPER-MULTI DRIVE 12.7MM TRAY DL 8X AD-7585H LF W/O BEZEL SATA FOR HF+WINDOWS7	KU.0080E.027
	2	ODD SONY SUPER-MULTI DRIVE 12.7MM TRAY DL 8X AD-7580S LF W/O BEZEL FW FX20 SATA FOR WINDOWS7	KU.0080E.030
	2	ODD PLDS SUPER-MULTI DRIVE 12.7MM TRAY DL 8X DS-8A4SH LF W/O BEZEL SATA FOR HF+WINDOWS7	KU.0080F.006
	2	ODD PLDS SUPER-MULTI DRIVE 12.7MM TRAY DL 8X DS-8A3S LF W/O BEZEL SATA FOR WINDOWS7	KU.0080F.008
	1	HDD MODULE 160GB 5400RPM SATA	
	2	HDD 160GB 5400RPM 2.5" SATA HGST HTS543216L9A300 F/W:C30C	KH.16007.019
	2	HDD 160GB 5400RPM 2.5" SATA WD WD1600BEVT-22ZCT0 FW:11.01A11	KH.16008.022
	1	HDD MODULE 250GB 5400RPM SATA	
<b>HDD/HARD DISK DRIVE</b>	2	HDD 2.5" 5400RPM 250GB SEAGATE ST9250315AS WYATT SATA LF F/W:0001SDM1	KH.25001.016
	2	HDD 250GB 5400RPM SATA HGST HTS543225L9A300 LF F/W:C40C	KH.25007.013
	2	HDD 250GB 5400RPM SATA HGST HTS545025B9A300 PANTHER-B LF	KH.25007.015
	2	HDD 250GB 5400RPM 2.5" SATA HGST HTS545025B9A300 PANTHER B LF F/W:C60F DISK IMBALANCE CRITERIA = 0.014G-CM	KH.25007.016
	2	HDD 250GB 5400RPM SATA WD WD2500BEVT-22ZCT0 F/W:11.01A11	KH.25008.021
	1	HDD MODULE 320GB 5400RPM SATA	
	2	HDD 320GB 5400RPM SATA HGST HTS545032B9A300 PANTHER B LF	KH.32007.007
	2	HDD 320GB 5400RPM SATA SEAGATE ST9320320AS F/W:2010	KH.32001.008
	2	HDD 320GB 5400RPM SATA HGST HTS543232L9A300 F/W:C30C	KH.32007.004
	2	HDD 320GB 5400RPM 2.5" SATA HGST HTS545032B9A300 PANTHER B LF F/W:C60F DISK IMBALANCE CRITERIA = 0.014G-CM	KH.32007.008
	2	HDD 320GB 5400RPM SATA WD WD3200BEVT-22ZCT0 ML125 F/W:01.01A01	KH.32008.013
	1	HDD MODULE 500GB 5400RPM SATA	
	2	HDD 500GB 5400RPM WD SATA WD5000BEVT-22ZAT0 F/W:01.01A01	KH.50008.013
	2	HDD 500GB 5400RPM SEAGATE ST9500325AS SATA LF F/W:0001SDM1	KH.50001.011
	2	HDD 500GB 5400RPM HGST SATA HTS545050B9A300 PANTHER B LF	KH.50007.009
	2	HDD HGST 2.5" 5400RPM 500GB HTS545050B9A300 PANTHER B SATA LF F/W:C60F DISK IMBALANCE CRITERIA = 0.014G-CM	KH.50007.010



Category	No.	Part Name & Description	Acer Part No.
<b>HEATSINK</b> 	1	CPU HEATSINK DISCRETE DDR2 W/FAN	60.PEY01.001
	1	CPU HEATSINK DISCRETE DDR2 W/FAN	60.PEY01.001
<b>KEYBOARD</b> 	1	KEYBOARD 104KEYS NSK-ALA0J AC7T JV50 INTERNAL 17 STANDARD BLACK TEXTURE GERMAN	KB.I170A.040
	1	KEYBOARD 103KEYS NSK-ALA0J AC7T JV50 INTERNAL 17 STANDARD BLACK TEXTURE RUSSIAN	KB.I170A.048
	1	KEYBOARD 104KEYS NSK-ALA0J AC7T JV50 INTERNAL 17 STANDARD BLACK TEXTURE UK	KB.I170A.055
	1	KEYBOARD 104KEYS NSK-ALA0J AC7T JV50 INTERNAL 17 STANDARD BLACK TEXTURE SWISS	KB.I170A.052
	1	KEYBOARD 103KEYS NSK-ALA0J AC7T JV50 INTERNAL 17 STANDARD BLACK TEXTURE TAIWAN	KB.I170A.036
	1	KEYBOARD 103KEYS NSK-ALA0J AC7T JV50 INTERNAL 17 STANDARD BLACK TEXTURE THAILAND	KB.I170A.053
	1	KEYBOARD 104KEYS NSK-ALA0J AC7T JV50 INTERNAL 17 STANDARD BLACK TEXTURE PORTUGAL	KB.I170A.047
	1	KEYBOARD 103KEYS NSK-ALA0J AC7T JV50 INTERNAL 17 STANDARD BLACK TEXTURE ARABIC	KB.I170A.032
	1	KEYBOARD 104KEYS NSK-ALA0J AC7T JV50 INTERNAL 17 STANDARD BLACK TEXTURE DANISH	KB.I170A.037
	1	KEYBOARD 104KEYS NSK-ALA0J AC7T JV50 INTERNAL 17 STANDARD BLACK TEXTURE ITALIAN	KB.I170A.043
	1	KEYBOARD 104KEYS NSK-ALA0J AC7T JV50 INTERNAL 17 STANDARD BLACK TEXTURE FRENCH	KB.I170A.039
	1	KEYBOARD 103KEYS NSK-ALA0J AC7T JV50 INTERNAL 17 STANDARD BLACK TEXTURE HEBREW	KB.I170A.057
	1	KEYBOARD 107KEYS NSK-ALA0J AC7T JV50 INTERNAL 17 STANDARD BLACK TEXTURE JAPANESE	KB.I170A.044
	1	KEYBOARD 103KEYS NSK-ALA0J AC7T JV50 INTERNAL 17 STANDARD BLACK TEXTURE GREEK	KB.I170A.041
	1	KEYBOARD 104KEYS NSK-ALA0J AC7T JV50 INTERNAL 17 STANDARD BLACK TEXTURE NORWEGIAN	KB.I170A.046
	1	KEYBOARD 104KEYS NSK-ALA0J AC7T JV50 INTERNAL 17 STANDARD BLACK TEXTURE HUNGARIAN	KB.I170A.042
	1	KEYBOARD 104KEYS NSK-ALA0J AC7T JV50 INTERNAL 17 STANDARD BLACK TEXTURE SPANISH	KB.I170A.050
	1	KEYBOARD 104KEYS NSK-ALA0J AC7T JV50 INTERNAL 17 STANDARD BLACK TEXTURE TURKISH	KB.I170A.054
	1	KEYBOARD 104KEYS NSK-ALA0J AC7T JV50 INTERNAL 17 STANDARD BLACK TEXTURE SWEDISH	KB.I170A.051
	1	KEYBOARD 104KEYS NSK-ALA0J AC7T JV50 INTERNAL 17 STANDARD BLACK TEXTURE CZECH/SLOVAK	KB.I170A.035
	1	KEYBOARD 104KEYS NSK-ALA0J AC7T JV50 INTERNAL 17 STANDARD BLACK TEXTURE BELGIAN	KB.I170A.033
	1	KEYBOARD 104KEYS NSK-ALA0J AC7T JV50 INTERNAL 17 STANDARD BLACK TEXTURE BRAZILIAN PORTUGUESE	KB.I170A.034
	1	KEYBOARD 103KEYS NSK-ALA0J AC7T JV50 INTERNAL 17 STANDARD BLACK TEXTURE US-INTERNATIONAL	KB.I170A.056
1	KEYBOARD 104KEYS NSK-ALA0J AC7T JV50 INTERNAL 17 STANDARD BLACK TEXTURE SLOVE	KB.I170A.049	







Category	No.	Part Name & Description	Acer Part No.
<b>KEYBOARD</b>	1	KEYBOARD 104KEYS NSK-ALAOJ AC7T JV50 INTERNAL 17 STANDARD BLACK TEXTURE NORDIC	KB.I170A.045
	1	KEYBOARD 104KEYS NSK-ALAOJ AC7T JV50 INTERNAL 17 STANDARD BLACK TEXTURE FRENCH ARABIC	KB.I170A.038
	1	KEYBOARD 104KEYS NSK-ALAOJ AC7T JV50 INTERNAL 17 STANDARD BLACK TEXTURE FRENCH CANADIAN	KB.I170A.058
<b>LCD</b> 	1	3D CCFL LCD MODULE 15.6" WXGA GLARE BLUE W/ ANTENNA*2&CAMERA (NONE 3G) FOR MMW	
	2	3D CCFL LCD MODULE 15.6" WXGA GLARE ARISAWA 09WS156CMC LF 220NIT 8MS	56.0719A.001
<b>MAINBOARD</b> 	1	MAINBOARD JV50_MV DDR2 DIS 3D M92XT AMD PM45 ICH9M VRAM DDRIII 800 1GB LF W/RTC BATTERY&MODEM BOARD FOR NONE 3G	55.4CG01.241G
	1	MAINBOARD JV50_MV DDR2 DIS 3D M92XT AMD PM45 ICH9M VRAM DDRIII 800 1GB LF W/RTC BATTERY&MODEM BOARD FOR NONE 3G	55.4CG01.251G
<b>MEMORY</b> 	1	SODIMM 1GB DDRII667 SAMSUNG M470T2864QZ3-CE6 LF	KN.1GB0B.016
	1	SODIMM 1GB DDRII667 HYNIX HYMP112S64CP6-Y5 LF	KN.1GB0G.012
	1	SODIMM 1GB DDRII 800 SAMSUNG M470T2864EH3-CF7 LF 64*16 0.055UM	KN.1GB0B.033
	1	SODIMM 2GB DDRII 800 SAMSUNG M470T5663EH3-CF7 LF 128*8 0.055UM	KN.2GB0B.018
	1	SODIMM 2GB DDRII667 SAMSUNG M470T5663QZ3-CE6 LF	KN.2GB0B.003
	1	SODIMM 2GB DDRII667 HYNIX HYMP125S64CP8-Y5 LF	KN.2GB0G.004
<b>MICROPHONE</b>	2	MICROPHONE	23.42231.001
	2	MICROPHONE	23.40544.001
	2	MICROPHONE	23.42238.001
	2	MICROPHONE	23.42239.001
<b>MISCELLANEOUS</b> 	1	3D GLASSES KUJIEN WTC001 FOR CLIP TYPE	90.4DI28.002
	1	3D GLASSES KUJIEN WT090A FOR WESTERN TYPE	90.4DI28.006
	1	3D GLASSES KUJIEN WT0911 FOR EASTERN TYPE	90.4DI28.005
	1	LCD SCREW RUBBER	47.AU401.001
	1	NAME PLATE AS5738DG	40.4CG58.001

Category	No.	Part Name & Description	Acer Part No.
<b>SCREWS</b>	1	SCREW M2.5X6	86.00E12.536
	1	SCREW M2X4	86.00E13.524
	1	SCREW M2.5*L8 NYLOK CR3+	86.00E34.738
	1	SCREW M2.5X10	86.1Z533.100
	1	SCREW MM2X3	86.9A522.3R0
	1	SCREW M2X4 WAFER NI	86.9A552.4R0
	1	SCREW MACH WAFER M3*L4 NI	86.9A554.4R0
<b>SPEAKER</b>	2	SPEAKER ON LOWER CASE	23.PAW01.001
	2	SPEAKER ON UPPER CASE	23.PAW01.002

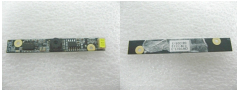

3. ACER\_ASPIRE 5738DZG M92XT512CBB 2V3\_JV50\_MV (NO:LX.PKF02.043)



Category	No.	Part Name & Description	Acer Part No.
<b>ADAPTER</b> 	1	ADAPTER 65W 19V 3PIN HIPRO HP-A0652R3B 1LF LV5 LED LF YELLOW	AP.0650A.012
	1	ADAPTER 65W 19V 3PIN DELTA ADP-65JH DB A LV5 LED LF YELLOW	AP.06501.026
	1	ADAPTER 65W 19V 3PIN LITEON PA-1650-22AC LV5 LED LF YELLOW	AP.06503.024
<b>BATTERY</b> 	1	BATTERY PANASONIC AS-2007A LI-ION 3S2P PANASONIC 6 CELL 4400MAH MAIN COMMON PSS	BT.00605.020
	1	BATTERY SANYO AS-2007A LI-ION 3S2P SANYO 6 CELL 4400MAH MAIN COMMON NORMAL TYPE	BT.00603.041
	1	BATTERY SONY AS-2007A LI-ION 3S2P SONY 6 CELL 4400MAH MAIN COMMON NORMAL TYPE	BT.00604.024
	1	BATTERY SIMPLO AS-2007A LI-ION 3S2P PANASONIC 6 CELL 4400MAH MAIN COMMON PSS	BT.00607.015
	1	BATTERY SIMPLO AS-2007A LI-ION 3S2P LGC 6 CELL 4400MAH 2ND COMMON	BT.00607.019
	1	BATTERY SIMPLO AS-2007A LI-ION 3S2P SAMSUNG 6 CELL 4400MAH MAIN COMMON SDI 2.2MAH F TYPE	BT.00607.034
<b>BOARDS</b> 	1	BLUETOOTH BOARD FOXCONN BCM2045 V2 T60H928.11	BT.21100.005
	1	BLUETOOTH BOARD FOXCONN BRM 2046 BT2.1 T60H928.33 F/W:861	BH.21100.004
	2	INVERTER BOARD YEC YNV-W15	19.AR501.001
	2	INVERTER BOARD FOXCONN T62I240.03 V.00	19.AR501.002
	2	INVERTER BOARD SUMIDA TWS-458-124 MS	19.AUA01.002
	2	INVERTER BOARD 17" DARFON VK.21189.408	19.TQ901.002
	1	LED BUTTON BOARD	55.PAT01.001
	1	MINI WLAN/B FOXCONN 802.11BG Atheros XB63 BG T60H976.00 FW:V06 MINICARD	NI.23600.007
	2	MODEM BOARD FOXCONN DELPHI-AM5 V2H 1.5_3.3V AUS T60M951.36	FX.22500.023
	2	MODEM BOARD LITEON CONEXANT -UNIZION 1.5_3.3V AUS B85247600G	FX.22500.021



Category	No.	Part Name & Description	Acer Part No.
<b>BOARDS</b>	1	TOUCH PAD BUTTON BOARD	55.PAW01.003
	1	TOUCHPAD BOARD SYNAPTICS TM00540-005	56.ATR01.001
	1	TOUCHPAD BOARD ALPS KGDF0038A	56.PAW01.001
	1	USB BOARD	55.PAT01.002
	1	WIRELESS LAN BOARD FOXCONN ATHEROS XB63 MINICARD B/G	NI.23600.046
	1	WIRELESS LAN BOARD 802.11BG FOXCONN T77H121.01 ATHEROS AR9285(HB95)	NI.23600.047
	1	WIRELESS LAN BOARD 802.11BGN FOXCONN T77H053.00 ATHEROS AR5B91 1X2	NI.23600.030
	1	WIRELESS LAN BOARD 802.11BGN QMI EM303-AR ATHEROS AR5B91 1X2 MINICARD	NI.23600.033
	1	WIRELESS LAN BOARD 802.11BGN FOXCONN T77H028.00 RALINK RT2700E 1X2	NI.23600.031
<b>CABLES</b>	1	BLUETOOTH BOARD CABLE	50.PAW01.004
	1	BLUETOOTH BOARD CALBE	50.ATR01.002
	1	BLUETOOTH BOARD CALBE	50.ATR01.002
	2	CCFL LCD/CAMERA CABLE	50.4CG13.002
	2	CCFL LCD/CAMERA CABLE	50.4CG13.012
	2	CCFL LCD/CAMERA CABLE	50.4CG13.022
	1	FINGER PRINT / TP BUTTON BOARD CABLE	50.PAW01.003
	2	LED BUTTON BOARD CABLE	50.4CG02.001
	2	LED BUTTON BOARD CABLE	50.4CG02.011
	2	MODEM CABLE	50.4CG04.011
	2	MODEM CABLE	50.4CG04.001
<b>CABLES</b>	1	POWER CORD 250V 3PIN EUR BK	27.T30V1.004
	1	POWER CABLE 16A 250V 3PIN EUR BK	27.01518.731
	1	POWER CORD 10A 250V ARGENTINE	27.01518.0U1
	1	POWER CORD 10A 125V US	27.T30V1.001
	1	POWER CORD 10A 125V 3PIN US BK	27.01518.641
	1	POWER CORD 7A 250V 2PIN KOREAN	27.01518.531
	1	POWER CORD 3A 250V 3PIN UK	27.01518.541

Category	No.	Part Name & Description	Acer Part No.
<b>CABLES</b>	1	POWER CORD 5A 250V 3PIN UK BK	27.03118.001
	1	POWER CORD 7A 125V 2PIN JAPAN	27.01518.551
	1	POWER CORD 10A 3PIN BK DENMARK	27.01518.561
	1	POWER CORD 10A 250V 3PIN DENMARK BK	27.01518.671
	1	POWER CORD 10A 250V 3PIN BK SOUTH AFRICA	27.01518.571
	1	POWER CORD 16A 250V SOUTH AFRICA BK	27.01518.681
	1	POWER CORD 10A 250V SWISS	27.01518.581
	1	POWER CORD 10A 250V 3PIN SWISS BK	27.01518.691
	1	POWER CORD 10A 250V 3PIN CHINA	27.01518.591
	1	POWER CORD 10A 250V 3PIN CHINA BK	27.01518.701
	1	POWER CORD 10A 250V 3PIN ITALY	27.01518.611
	1	POWER CORD 10A 250V 3PIN ITALY BK	27.01518.711
	1	POWER CORD 2.5A 250V AUSTRALIA	27.01518.621
	1	POWER CORD 2.5A 250V SOUTH AFRICA BK (INDIA)	27.01518.631
	1	POWER CORD 10A 250V SOUTH AFRICA BK (INDIA)	27.01518.721
	1	POWER CORD 7A 125V 2PIN JAPAN BK	27.01518.661
	1	POWER CORD 250V 10A 3PIN ISRAEL	27.01518.761
	1	POWER CORD 2.5A 125V USA	27.01518.781
	1	POWER CORD 2.5A 125V 1.8M BLACK TAIWANESE	27.01518.A11
	1	POWER CORD 10A 250V 1.8M BRAZIL BLK	27.01518.A41
	1	POWER CORD ACA / ACNZ	27.03218.021
	1	POWER CORD 7.5A 250V 3P AUSTRALIA BK	27.03218.051
	1	POWER CORD 7A 125V 2PIN JAPAN	27.03518.161
1	TOUCHPAD CABLE	50.PAW01.001	
1	USB BOARD CABLE	50.PAW01.002	
<b>CAMERA</b>	2	CAMERA 0.3M CHICONY CNF701721004973L	57.W9401.001
			
	2	CAMERA 0.3M SUYIN CN0314-SN30-OV03-5	57.N4401.001
			
<b>CASE/COVER/ BRACKET ASSEMBLY</b>	2	3D FILM LCD BRACKET W/HINGE RIGHT	34.4CG34.001
			
	2	3D FILM LCD BRACKET W/HINGE LEFT	34.4CG35.001
			
	2	BLUE-RAY COMBO BEZEL	42.PAW01.005
			
	2	DVD-RW SUPER-MULTI BEZEL	42.PAW01.004

Category	No.	Part Name & Description	Acer Part No.	
<b>CASE/COVER/ BRACKET ASSEMBLY</b>	2	LCD COVER IMR 15.6" BLUE W/ANTENNA*2 & LOGO NONE 3G FOR HMW	60.4CG61.001	
	2	LCD BEZEL 15.6" W/CAMERA HOLE	60.4CG60.001	
		1	LOWER CASE W/MODEM CABLE&SPEAKER	60.PAW01.001
		1	MIDDLE COVER W/BLUETOOTH BUTTON WITH BLUE LIGHT NONE 3G BUTTON	42.PAW01.001
		2	OPTICAL BRACKET	33.PAW01.002
		1	SD DUMMY CARD	42.TKJ01.001
		1	TOUCHPAD BRACKET	33.PAW01.001
		1	UNITLOAD COVER	42.PAW01.002
		1	UPPER CASE BLUE W/LED BUTTON BOARD CABLE&MICROPHONE&SPEAKER W/O FINGER PRINT HOLE	60.PAW01.002
		1	WIRELESS LAN COVER	42.PAW01.003
<b>COMBO MODULE</b>	1	BLU-RAY COMBO MODULE 4X SATA FOR WINDOWS7		
	1	BLU-RAY COMBO MODULE 4X SATA	6M.PAW01.001	
		2	ODD PIONEER BD COMBO 12.7 SATA DL 4X BDC-TD01RS LF W/O BEZEL SATA	KO.00405.002
		2	ODD HLDS BD COMBO 12.7MM TRAY DL 4X CT10 LF W/O BEZEL SATA	KO.0040D.002
		2	ODD PLDS BD COMBO 12.7MM TRAY DL 4X DS-4E1S LF W/O BEZEL SATA	KO.0040F.001
		2	ODD PLDS BD COMBO 12.7MM TRAY DL 4X DS-4E1S LF W/O BEZEL SATA FOR WINDOWS7	KO.0040F.003
		2	ODD PIONEER BD COMBO 12.7MM TRAY DL 4X SATA BDC-TD01RS LF W/O BEZEL FOR WINDOWS7	KO.00405.003

Category	No.	Part Name & Description	Acer Part No.
<b>CPU/PROCESSOR</b> 	1	CPU INTEL PENTIUM DUAL-CORE T4300 PGA 2.1G 1M 800 R-0	KC.43001.DTP
	1	CPU INTEL PENTIUM DUAL-CORE T4200 PGA 2.0G 1M 800 35W R-0	KC.42001.DTP
	1	CPU INTEL MEROM PENTIUM DUAL-CORE T3400 2.16G 1M 667 MV	KC.34001.DTP
<b>DVD-RW DRIVE</b>	1	DVD-RW SUPER-MULTI MODULE 8X SATA	6M.PAW01.002
	2	ODD TOSHIBA SUPER-MULTI DRIVE 12.7MM TRAY DL 8X SATA TS-L633B LF W/O BEZEL	KU.00801.030
	2	ODD HLDS SUPER-MULTI DRIVE 12.7MM TRAY DL 8X GT20N LF W/O BEZEL SATA	KU.0080D.040
	2	ODD SONY SUPER-MULTI DRIVE 12.7MM TRAY DL 8X AD-7580S LF W/O BEZEL SATA	KU.0080E.017
	2	ODD SONY SUPER-MULTI DRIVE 12.7MM TRAY DL 8X AD-7590S LF W/O BEZEL SATA	KU.0080E.025
	2	ODD PLDS SUPER-MULTI DRIVE 12.7MM TRAY DL 8X SATA DS-8A3S LF W/O BEZEL	KU.0080F.004
	1	DVD-RW SUPER-MULTI MODULE 8X SATA FOR WINDOWS7	
	2	ODD HLDS SUPER-MULTI DRIVE 12.7MM TRAY DL 8X GT30N LF W/O BEZEL SATA FOR HF+WINDOWS7	KU.0080D.048
	2	ODD TOSHIBA SUPER-MULTI DRIVE 12.7MM TRAY DL 8X TS-L633C LF W/O BEZEL SATA FOR HF+WINDOWS7	KU.00801.035
	2	ODD TOSHIBA SUPER-MULTI DRIVE 12.7MM TRAY DL 8X TS-L633B LF W/O BEZEL AC02 SATA FOR WINDOWS7	KU.00801.036
	2	ODD PANASONIC SUPER-MULTI DRIVE 12.7MM TRAY DL 8X UJ890A LF W/O BEZEL SATA HF+WINDOWS 7	KU.00807.070
	2	ODD HLDS SUPER-MULTI DRIVE 8X 12.7MM TRAY DL GT20N LF W/O BEZEL CP03 SATA FOR WINDOWS7	KU.0080D.051
	2	ODD SONY SUPER-MULTI DRIVE 12.7MM TRAY DL 8X AD-7585H LF W/O BEZEL SATA FOR HF+WINDOWS7	KU.0080E.027
	2	ODD SONY SUPER-MULTI DRIVE 12.7MM TRAY DL 8X AD-7580S LF W/O BEZEL FW FX20 SATA FOR WINDOWS7	KU.0080E.030
	2	ODD PLDS SUPER-MULTI DRIVE 12.7MM TRAY DL 8X DS-8A4SH LF W/O BEZEL SATA FOR HF+WINDOWS7	KU.0080F.006
	2	ODD PLDS SUPER-MULTI DRIVE 12.7MM TRAY DL 8X DS-8A3S LF W/O BEZEL SATA FOR WINDOWS7	KU.0080F.008
<b>HDD/HARD DISK DRIVE</b> 	1	HDD MODULE 160GB 5400RPM SATA	
	2	HDD 160GB 5400RPM 2.5" SATA HGST HTS543216L9A300 F/W:C30C	KH.16007.019
	2	HDD 160GB 5400RPM 2.5" SATA WD WD1600BEVT-22ZCT0 FW:11.01A11	KH.16008.022
	1	HDD MODULE 250GB 5400RPM SATA	
	2	HDD 2.5" 5400RPM 250GB SEAGATE ST9250315AS WYATT SATA LF F/W:0001SDM1	KH.25001.016
	2	HDD 250GB 5400RPM SATA HGST HTS543225L9A300 LF F/W:C40C	KH.25007.013
	2	HDD 250GB 5400RPM SATA HGST HTS545025B9A300 PANTHER-B LF	KH.25007.015
	2	HDD 250GB 5400RPM 2.5" SATA HGST HTS545025B9A300 PANTHER B LF F/W:C60F DISK IMBALANCE CRITERIA = 0.014G-CM	KH.25007.016

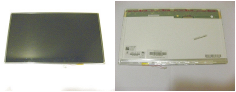
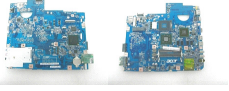

Category	No.	Part Name & Description	Acer Part No.	
<b>HDD/HARD DISK DRIVE</b>	2	HDD 250GB 5400RPM SATA WD WD2500BEVT-22ZCT0 F/W:11.01A11	KH.25008.021	
	1	HDD MODULE 320GB 5400RPM SATA		
	2	HDD 320GB 5400RPM SATA HGST HTS545032B9A300 PANTHER B LF	KH.32007.007	
	2	HDD 320GB 5400RPM SATA SEAGATE ST9320320AS F/W:2010	KH.32001.008	
	2	HDD 320GB 5400RPM SATA HGST HTS543232L9A300 F/W:C30C	KH.32007.004	
	2	HDD 320GB 5400RPM 2.5" SATA HGST HTS545032B9A300 PANTHER B LF F/W:C60F DISK IMBALANCE CRITERIA = 0.014G-CM	KH.32007.008	
	2	HDD 320GB 5400RPM SATA WD WD3200BEVT-22ZCT0 ML125 F/W:01.01A01	KH.32008.013	
	1	HDD MODULE 500GB 5400RPM SATA		
	2	HDD 500GB 5400RPM WD SATA WD5000BEVT-22ZAT0 F/W:01.01A01	KH.50008.013	
	2	HDD 500GB 5400RPM SEAGATE ST9500325AS SATA LF F/W:0001SDM1	KH.50001.011	
	2	HDD 500GB 5400RPM HGST SATA HTS545050B9A300 PANTHER B LF	KH.50007.009	
	2	HDD HGST 2.5" 5400RPM 500GB HTS545050B9A300 PANTHER B SATA LF F/W:C60F DISK IMBALANCE CRITERIA = 0.014G-CM	KH.50007.010	
	<b>HEATSINK</b> 	1	CPU HEATSINK DISCRETE DDR2 W/FAN	60.PEY01.001
		1	CPU HEATSINK DISCRETE DDR2 W/FAN	60.PEY01.001
<b>KEYBOARD</b> 	1	KEYBOARD 104KEYS NSK-ALAOJ AC7T JV50 INTERNAL 17 STANDARD BLACK TEXTURE SPANISH	KB.1170A.050	
	1	KEYBOARD 103KEYS NSK-ALAOJ AC7T JV50 INTERNAL 17 STANDARD BLACK TEXTURE RUSSIAN	KB.1170A.048	
	1	KEYBOARD 104KEYS NSK-ALAOJ AC7T JV50 INTERNAL 17 STANDARD BLACK TEXTURE GERMAN	KB.1170A.040	
	1	KEYBOARD 104KEYS NSK-ALAOJ AC7T JV50 INTERNAL 17 STANDARD BLACK TEXTURE UK	KB.1170A.055	
	1	KEYBOARD 104KEYS NSK-ALAOJ AC7T JV50 INTERNAL 17 STANDARD BLACK TEXTURE SWISS	KB.1170A.052	
	1	KEYBOARD 103KEYS NSK-ALAOJ AC7T JV50 INTERNAL 17 STANDARD BLACK TEXTURE TAIWAN	KB.1170A.036	
	1	KEYBOARD 103KEYS NSK-ALAOJ AC7T JV50 INTERNAL 17 STANDARD BLACK TEXTURE THAILAND	KB.1170A.053	
	1	KEYBOARD 104KEYS NSK-ALAOJ AC7T JV50 INTERNAL 17 STANDARD BLACK TEXTURE PORTUGAL	KB.1170A.047	
	1	KEYBOARD 103KEYS NSK-ALAOJ AC7T JV50 INTERNAL 17 STANDARD BLACK TEXTURE ARABIC	KB.1170A.032	
	1	KEYBOARD 103KEYS NSK-ALAOJ AC7T JV50 INTERNAL 17 STANDARD BLACK TEXTURE ARABIC	KB.1170A.032	
	1	KEYBOARD 104KEYS NSK-ALAOJ AC7T JV50 INTERNAL 17 STANDARD BLACK TEXTURE DANISH	KB.1170A.037	
	1	KEYBOARD 104KEYS NSK-ALAOJ AC7T JV50 INTERNAL 17 STANDARD BLACK TEXTURE DANISH	KB.1170A.037	
	1	KEYBOARD 104KEYS NSK-ALAOJ AC7T JV50 INTERNAL 17 STANDARD BLACK TEXTURE ITALIAN	KB.1170A.043	

Category	No.	Part Name & Description	Acer Part No.
<b>KEYBOARD</b>	1	KEYBOARD 104KEYS NSK-ALAOJ AC7T JV50 INTERNAL 17 STANDARD BLACK TEXTURE FRENCH	KB.I170A.039
	1	KEYBOARD 103KEYS NSK-ALAOJ AC7T JV50 INTERNAL 17 STANDARD BLACK TEXTURE HEBREW	KB.I170A.057
	1	KEYBOARD 107KEYS NSK-ALAOJ AC7T JV50 INTERNAL 17 STANDARD BLACK TEXTURE JAPANESE	KB.I170A.044
	1	KEYBOARD 103KEYS NSK-ALAOJ AC7T JV50 INTERNAL 17 STANDARD BLACK TEXTURE GREEK	KB.I170A.041
	1	KEYBOARD 104KEYS NSK-ALAOJ AC7T JV50 INTERNAL 17 STANDARD BLACK TEXTURE NORWEGIAN	KB.I170A.046
	1	KEYBOARD 104KEYS NSK-ALAOJ AC7T JV50 INTERNAL 17 STANDARD BLACK TEXTURE HUNGARIAN	KB.I170A.042
	1	KEYBOARD 104KEYS NSK-ALAOJ AC7T JV50 INTERNAL 17 STANDARD BLACK TEXTURE TURKISH	KB.I170A.054
	1	KEYBOARD 104KEYS NSK-ALAOJ AC7T JV50 INTERNAL 17 STANDARD BLACK TEXTURE SWEDISH	KB.I170A.051
	1	KEYBOARD 104KEYS NSK-ALAOJ AC7T JV50 INTERNAL 17 STANDARD BLACK TEXTURE CZECH/SLOVAK	KB.I170A.035
	1	KEYBOARD 104KEYS NSK-ALAOJ AC7T JV50 INTERNAL 17 STANDARD BLACK TEXTURE BELGIAN	KB.I170A.033
	1	KEYBOARD 104KEYS NSK-ALAOJ AC7T JV50 INTERNAL 17 STANDARD BLACK TEXTURE BRAZILIAN PORTUGUESE	KB.I170A.034
	1	KEYBOARD 103KEYS NSK-ALAOJ AC7T JV50 INTERNAL 17 STANDARD BLACK TEXTURE US-INTERNATIONAL	KB.I170A.056
	1	KEYBOARD 104KEYS NSK-ALAOJ AC7T JV50 INTERNAL 17 STANDARD BLACK TEXTURE SLOVE	KB.I170A.049
	1	KEYBOARD 104KEYS NSK-ALAOJ AC7T JV50 INTERNAL 17 STANDARD BLACK TEXTURE NORDIC	KB.I170A.045
	1	KEYBOARD 104KEYS NSK-ALAOJ AC7T JV50 INTERNAL 17 STANDARD BLACK TEXTURE FRENCH ARABIC	KB.I170A.038
	1	KEYBOARD 104KEYS NSK-ALAOJ AC7T JV50 INTERNAL 17 STANDARD BLACK TEXTURE FRENCH CANADIAN	KB.I170A.058
<b>LCD</b> 	1	3D CCFL LCD MODULE 15.6" WXGA GLARE BLUE W/ ANTENNA*2&CAMERA (NONE 3G) FOR HMW	
	2	3D CCFL LCD MODULE 15.6" WXGA GLARE ARISAWA 09WS156CMC LF 220NIT 8MS	56.0719A.001
<b>MAINBOARD</b> 	1	MAINBOARD JV50_MV DDR2 DIS 3D M92XT AMD GM45 ICH9M VRAM DDRIII 800 1GB LF W/RTC BATTERY&MODEM BOARD FOR NONE 3G	55.4CG01.261G
	1	MAINBOARD JV50_MV DDR2 DIS 3D M92XT AMD GM45 ICH9M VRAM DDRIII 800 1GB LF W/RTC BATTERY&MODEM BOARD FOR NONE 3G	55.4CG01.271G
<b>MEMORY</b> 	1	SODIMM 1GB DDRII667 SAMSUNG M470T2864QZ3-CE6 LF	KN.1GB0B.016
	1	SODIMM 1GB DDRII667 HYNIX HYMP112S64CP6-Y5 LF	KN.1GB0G.012
	1	SODIMM 1GB DDRII 800 SAMSUNG M470T2864EH3-CF7 LF 64*16 0.055UM	KN.1GB0B.033
	1	SODIMM 2GB DDRII 800 SAMSUNG M470T5663EH3-CF7 LF 128*8 0.055UM	KN.2GB0B.018
	1	SODIMM 2GB DDRII667 SAMSUNG M470T5663QZ3-CE6 LF	KN.2GB0B.003
	1	SODIMM 2GB DDRII667 HYNIX HYMP125S64CP8-Y5 LF	KN.2GB0G.004

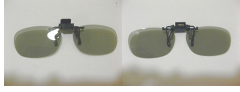
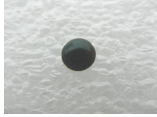

Category	No.	Part Name & Description	Acer Part No.
<b>MICROPHONE</b>	2	MICROPHONE	23.42231.001
	2	MICROPHONE	23.40544.001
	2	MICROPHONE	23.42238.001
	2	MICROPHONE	23.42239.001
<b>MISCELLANEOUS</b> 	1	3D GLASSES KUJIEN WTC001 FOR CLIP TYPE	90.4DI28.002
	1	3D GLASSES KUJIEN WT090A FOR WESTERN TYPE	90.4DI28.006
	1	3D GLASSES KUJIEN WT0911 FOR EASTERN TYPE	90.4DI28.005
	1	LCD SCREW RUBBER	47.AU401.001
	1	NAME PLATE AS5738DZG	40.4CG59.001
<b>SCREWS</b>	1	SCREW M2.5X6	86.00E12.536
	1	SCREW M2X4	86.00E13.524
	1	SCREW M2.5*L8 NYLOK CR3+	86.00E34.738
	1	SCREW M2.5X10	86.1Z533.100
	1	SCREW M2X3	86.9A522.3R0
	1	SCREW M2*4 WAFER NI	86.9A552.4R0
	1	SCREW MACH WAFER M3*L4 NI	86.9A554.4R0
<b>SPEAKER</b>	2	SPEAKER ON LOWER CASE	23.PAW01.001
	2	SPEAKER ON UPPER CASE	23.PAW01.002

4. ACER\_ASPIRE 5542 UMABB\_JV50\_TR (NO: LX.PH902.001 )



Category	No.	Part Name & Description	Acer Part No.
<b>ADAPTER</b> 	1	ADAPTER 65W 19V 3PIN DELTA ADP-65JH DB A LV5 LED LF YELLOW	AP.06501.026
	1	ADAPTER 65W 19V 3PIN LITEON PA-1650-22AC LV5 LED LF YELLOW	AP.06503.024
	1	ADAPTER 65W 19V 3PIN HIPRO HP-A0652R3B 1LF LV5 LED LF YELLOW	AP.0650A.012
<b>BATTERY</b> 	1	BATTERY SANYO AS-2007A LI-ION 3S2P SANYO 6 CELL 4400MAH MAIN COMMON NORMAL TYPE	BT.00603.041
	1	BATTERY SONY AS-2007A LI-ION 3S2P SONY 6 CELL 4400MAH MAIN COMMON NORMAL TYPE	BT.00604.024
	1	BATTERY PANASONIC AS-2007A LI-ION 3S2P PANASONIC 6 CELL 4400MAH MAIN COMMON PSS	BT.00605.020
	1	BATTERY SIMPLO AS-2007A LI-ION 3S2P PANASONIC 6 CELL 4400MAH MAIN COMMON PSS	BT.00607.015
	1	BATTERY SIMPLO AS-2007A LI-ION 3S2P LGC 6 CELL 4400MAH 2ND COMMON	BT.00607.019
	1	BATTERY SIMPLO AS-2007A LI-ION 3S2P SAMSUNG 6 CELL 4400MAH MAIN COMMON SDI 2.2MAH F TYPE	BT.00607.034

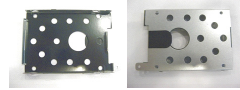

Category	No.	Part Name & Description	Acer Part No.
<b>BOARDS</b> 	1	BLUETOOTH BOARD FOXCONN BRM 2046 BT2.1 T60H928.33 F/W:861	BH.21100.004
	2	INVERTER BOARD FOXCONN T62I240.03 V.00	19.AR501.002
	2	INVERTER BOARD YEC YNV-W15	19.AR501.001
	1	LED BUTTON BOARD	55.4FN03.001G
	2	MODEM BOARD LITEON CONEXANT -UNIZION 1.5_3.3V AUS B85247600G	FX.22500.021
	1	TOUCHPAD BOARD SYNAPTICS TM00540-005	56.ATR01.001
	1	TOUCHPAD BOARD ALPS KGDFFF0038A	56.PAW01.001
	1	TOUCH PAD BUTTON BOARD	55.PAW01.003
	1	USB BOARD	55.4FN02.001G
	1	WIRELESS LAN BOARD FOXCONN ATHEROS XB63 MINICARD B/G	NI.23600.046
	1	WIRELESS LAN BOARD QMI ATHEROS HB93 1X2 BGN HM EM306	NI.23600.054
	1	WIRELESS LAN BOARD 802.11BG FOXCONN T77H121.01 ATHEROS AR9285(HB95)	NI.23600.047
<b>CABLES</b> 	1	BLUETOOTH BOARD CABLE	50.PAW01.004
	1	BLUETOOTH BOARD CALBE	50.ATR01.002
	1	FINGER PRINT / TP BUTTON BOARD CABLE	50.PAW01.003
	2	LCD CABLE W/O CAMERA	50.PAQ01.002
	2	LED BUTTON BOARD CABLE	50.4CG02.001
	2	LED BUTTON BOARD CABLE	50.4CG02.011
	2	LED CABLE W/O CAMERA	50.PAQ01.001
	2	MODEM CABLE	50.4CG04.011

Category	No.	Part Name & Description	Acer Part No.
<b>CABLES</b>	2	MODEM CABLE	50.4CG04.001
	1	POWER CORD 250V 3PIN EUR BK	27.T30V1.004
	1	POWER CABLE 16A 250V 3PIN EUR BK	27.01518.731
	1	POWER CORD 10A 125V US	27.T30V1.001
	1	POWER CORD 10A 125V 3PIN US BK	27.01518.641
	1	POWER CORD 10A 250V ARGENTINE	27.01518.0U1
		POWER CORD 7A 250V 2PIN KOREAN	27.01518.531
		POWER CORD 3A 250V 3PIN UK	27.01518.541
		POWER CORD 5A 250V 3PIN UK BK	27.03118.001
		POWER CORD 7A 125V 2PIN JAPAN	27.01518.551
		POWER CORD 10A 3PIN BK DENMARK	27.01518.561
		POWER CORD 10A 250V 3PIN DENMARK BK	27.01518.671
		POWER CORD 10A 250V 3PIN BK SOUTH AFRICA	27.01518.571
		POWER CORD 16A 250V SOUTH AFRICA BK	27.01518.681
		POWER CORD 10A 250V SWISS	27.01518.581
		POWER CORD 10A 250V 3PIN SWISS BK	27.01518.691
		POWER CORD 10A 250V 3PIN CHINA	27.01518.591
		POWER CORD 10A 250V 3PIN CHINA BK	27.01518.701
		POWER CORD 10A 250V 3PIN ITALY	27.01518.611
		POWER CORD 10A 250V 3PIN ITALY BK	27.01518.711
		POWER CORD 2.5A 250V AUSTRALIA	27.01518.621
		POWER CORD 2.5A 250V SOUTH AFRICA BK (INDIA)	27.01518.631
		POWER CORD 10A 250V SOUTH AFRICA BK (INDIA)	27.01518.721
		POWER CORD 7A 125V 2PIN JAPAN BK	27.01518.661
		1 POWER CORD 250V 10A 3PIN ISRAEL	27.01518.761
		1 POWER CORD 2.5A 125V USA	27.01518.781
		1 POWER CORD 2.5A 125V 1.8M BLACK TAIWANESE	27.01518.A11
		1 POWER CORD 10A 250V 1.8M BRAZIL BLK	27.01518.A41
		1 POWER CORD ACA / ACNZ	27.03218.021
	1 POWER CORD 7.5A 250V 3P AUSTRALIA BK	27.03218.051	
	1 POWER CODE 7A 125V 2PIN JAPAN	27.03518.161	
	1 TOUCHPAD CABLE	50.PAW01.001	
	1 USB BOARD CABLE	50.PAW01.002	
<b>CASE/COVER/ BRACKET ASSEMBLY</b>	2	BLUE-RAY COMBO BEZEL	42.PAW01.005
			
	2	DVD-RW SUPER-MULTI BEZEL	42.PAW01.004
	2	HDD BRACKET	33.PAW01.003
	2	LCD BEZEL 15.6" W/O CAMERA HOLE	60.PAQ01.001
	2	LCD BRACKET W/HINGE LEFT	33.PAW01.006
	2	LCD BRACKET W/HINGE RIGHT	33.ATR01.004

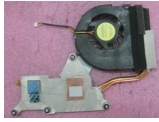
Category	No.	Part Name & Description	Acer Part No.
<b>CASE/COVER/ BRACKET ASSEMBLY</b> 	2	LCD COVER IMR 15.6" BLUE W/ANTENNA*2 & LOGO	60.PEZ01.001
		2	LED LCD BRACKET RIGHT W/HINGE
	2	LED LCD BRACKET LEFT W/HINGE	33.PAW01.004
	1	LOWER CASE W/MODEM CABLE&SPEAKER	60.PAW01.001
	1	MIDDLE COVER W/BLUETOOTH BUTTON WITH BLUE LIGHT NONE 3G BUTTON	42.PAW01.001
	2	OPTICAL BRACKET	33.PAW01.002
	1	SD DUMMY CARD	42.TKJ01.001
	1	TOUCHPAD BRACKET	33.PAW01.001
	1	UNITLOAD COVER	42.PAW01.002
	1	UPPER CASE BLUE W/LED BUTTON BOARD CABLE&MICROPHONE&SPEAKER W/O FINGER PRINT HOLE	60.PAW01.002
	1	WIRELESS LAN COVER	42.PAW01.003
<b>COMBO MODULE</b> 	1	BLU-RAY COMBO MODULE 4X SATA FOR WINDOWS7	
	2	ODD PIONEER BD COMBO 12.7MM TRAY DL 4X SATA BDC-TD01RS LF W/O BEZEL FOR WINDOWS7	KO.00405.003
	2	ODD PLDS BD COMBO 12.7MM TRAY DL 4X DS-4E1S LF W/O BEZEL SATA FOR WINDOWS7	KO.0040F.003



Category	No.	Part Name & Description	Acer Part No.
<b>CPU/PROCESSOR</b> 	1	CPU AMD ATHLONII M300 2.0G 1M 35W CASPIAN	KC.AM002.300
	1	CPU AMD ATHLONII M320 2.1G 1M 35W CASPIAN	KC.AM002.320
	1	CPU AMD SEMPRONM M100 2.0G 512K 25W CASPIAN	KC.SM002.100
	1	CPU AMD TURIONII M500 2.2G 1M 35W	KC.TM002.500
	1	CPU AMD TURIONII M520 2.3G 1M 35W	KC.TM002.520
	1	CPU AMD TURION M600 2.4G 2M 35W CASPIAN	KC.TM002.600
	1	CPU AMD TURION M620 2.5G 2M 35W CASPIAN	KC.TM002.620
	1	CPU AMD TURION M640 2.6G 2M 35W CASPIAN	KC.TM002.640
<b>DVD-RW DRIVE</b>	1	DVD-RW SUPER-MULTI MODULE 8X SATA FOR WINDOWS7	
	2	ODD HLDS SUPER-MULTI DRIVE 12.7MM TRAY DL 8X GT30N LF W/O BEZEL SATA FOR HF+WINDOWS7	KU.0080D.048
	2	ODD TOSHIBA SUPER-MULTI DRIVE 12.7MM TRAY DL 8X TS-L633C LF W/O BEZEL SATA FOR HF+WINDOWS7	KU.00801.035
	2	ODD PANASONIC SUPER-MULTI DRIVE 12.7MM TRAY DL 8X UJ890A LF W/O BEZEL SATA HF+WINDOWS 7	KU.00807.070
<b>HDD/HARD DISK DRIVE</b> 	1	HDD MODULE 160GB 5400RPM SATA	
	2	HDD 160GB 5400RPM 2.5" SATA WYATT SEAGATE ST9160314AS F/W:0001SDM1	KH.16001.042
	2	HDD 160GB 5400RPM SATA TOSHIBA LIBRA-BS MK1655GSX F/W:FG0101J 5.4	KH.16004.006
	2	HDD 160GB 5400RPM SATA HGST PANTHER-B PANTHER-B HTS545016B9A300 F/W:C60F	KH.16007.024
	2	HDD 160GB 5400RPM 2.5" SATA WD WD1600BEVT-22ZCT0 FW:11.01A11	KH.16008.022
	1	HDD MODULE 250GB 5400RPM SATA	
	2	HDD 2.5" 5400RPM 250GB SEAGATE ST9250315AS WYATT SATA LF F/W:0001SDM1	KH.25001.016
	2	HDD 250GB 5400RPM SATA TOSHIBA LIBRA-BS MK2555GSX F/W:FG000J 5.4K	KH.25004.003
	2	HDD 250GB 5400RPM SATA HGST HTS545025B9A300 PANTHER-B LF	KH.25007.015
	2	HDD 250GB 5400RPM SATA WD WD2500BEVT-22ZCT0 F/W:11.01A11	KH.25008.021
	1	HDD MODULE 320GB 5400RPM SATA	
	2	HDD 320GB 5400RPM SATA HGST HTS545032B9A300 PANTHER B LF	KH.32007.007
	2	HDD 320GB 5400RPM SATA SEAGATE WYATT ST9320325AS FW:0001SDM1	KH.32001.017
	2	HDD 320GB 5400RPM SATA TOSHIBA MK3255GSX LIBRA LF F/W:FG010J	KH.32004.002
	2	HDD 320GB 5400RPM SATA WD WD3200BEVT-22ZCT0 ML125 F/W:01.01A01	KH.32008.013
	1	HDD MODULE 500GB 5400RPM SATA	
	2	HDD 500GB 5400RPM HGST SATA HTS545050B9A300 PANTHER B LF	KH.50007.009
	2	HDD 500GB 5400RPM SEAGATE ST9500325AS SATA LF F/W:0001SDM1	KH.50001.011
	2	HDD 2.5" 5400RPM 500GB TOSHIBA MK5055GSX LIBRA SATA LF F/W:FG001J	KH.50004.001
	2	HDD 500GB 5400RPM WD SATA WD5000BEVT-22ZAT0 F/W:01.01A01	KH.50008.013

Category	No.	Part Name & Description	Acer Part No.
<b>HEATSINK</b> 	1	CPU HEATSINK UMA W/FAN	60.4FN03.001
	1	CPU HEATSINK UMA W/FAN	60.4FN05.001
	1	CPU HEATSINK UMA W/FAN	60.4FN07.001
<b>KEYBOARD</b> 	1	KEYBOARD 104KEYS NSK-ALA0J AC7T JV50 INTERNAL 17 STANDARD BLACK TEXTURE GERMAN	KB.I170A.040
	1	KEYBOARD 104KEYS NSK-ALA0J AC7T JV50 INTERNAL 17 STANDARD BLACK TEXTURE UK	KB.I170A.055
	1	KEYBOARD 104KEYS NSK-ALA0J AC7T JV50 INTERNAL 17 STANDARD BLACK TEXTURE SWISS	KB.I170A.052
	1	KEYBOARD 103KEYS NSK-ALA0J AC7T JV50 INTERNAL 17 STANDARD BLACK TEXTURE TAIWAN	KB.I170A.036
	1	KEYBOARD 103KEYS NSK-ALA0J AC7T JV50 INTERNAL 17 STANDARD BLACK TEXTURE THAILAND	KB.I170A.053
	1	KEYBOARD 104KEYS NSK-ALA0J AC7T JV50 INTERNAL 17 STANDARD BLACK TEXTURE PORTUGAL	KB.I170A.047
	1	KEYBOARD 103KEYS NSK-ALA0J AC7T JV50 INTERNAL 17 STANDARD BLACK TEXTURE ARABIC	KB.I170A.032
	1	KEYBOARD 104KEYS NSK-ALA0J AC7T JV50 INTERNAL 17 STANDARD BLACK TEXTURE DANISH	KB.I170A.037
	1	KEYBOARD 104KEYS NSK-ALA0J AC7T JV50 INTERNAL 17 STANDARD BLACK TEXTURE ITALIAN	KB.I170A.043
	1	KEYBOARD 104KEYS NSK-ALA0J AC7T JV50 INTERNAL 17 STANDARD BLACK TEXTURE FRENCH	KB.I170A.039
	1	KEYBOARD 103KEYS NSK-ALA0J AC7T JV50 INTERNAL 17 STANDARD BLACK TEXTURE HEBREW	KB.I170A.057
	1	KEYBOARD 107KEYS NSK-ALA0J AC7T JV50 INTERNAL 17 STANDARD BLACK TEXTURE JAPANESE	KB.I170A.044
	1	KEYBOARD 103KEYS NSK-ALA0J AC7T JV50 INTERNAL 17 STANDARD BLACK TEXTURE GREEK	KB.I170A.041
	1	KEYBOARD 104KEYS NSK-ALA0J AC7T JV50 INTERNAL 17 STANDARD BLACK TEXTURE NORWEGIAN	KB.I170A.046
	1	KEYBOARD 104KEYS NSK-ALA0J AC7T JV50 INTERNAL 17 STANDARD BLACK TEXTURE HUNGARIAN	KB.I170A.042
	1	KEYBOARD 103KEYS NSK-ALA0J AC7T JV50 INTERNAL 17 STANDARD BLACK TEXTURE RUSSIAN	KB.I170A.048
	1	KEYBOARD 104KEYS NSK-ALA0J AC7T JV50 INTERNAL 17 STANDARD BLACK TEXTURE SPANISH	KB.I170A.050
	1	KEYBOARD 104KEYS NSK-ALA0J AC7T JV50 INTERNAL 17 STANDARD BLACK TEXTURE TURKISH	KB.I170A.054
	1	KEYBOARD 104KEYS NSK-ALA0J AC7T JV50 INTERNAL 17 STANDARD BLACK TEXTURE SWEDISH	KB.I170A.051
	1	KEYBOARD 104KEYS NSK-ALA0J AC7T JV50 INTERNAL 17 STANDARD BLACK TEXTURE CZECH/SLOVAK	KB.I170A.035
	1	KEYBOARD 104KEYS NSK-ALA0J AC7T JV50 INTERNAL 17 STANDARD BLACK TEXTURE BELGIAN	KB.I170A.033
	1	KEYBOARD 104KEYS NSK-ALA0J AC7T JV50 INTERNAL 17 STANDARD BLACK TEXTURE BRAZILIAN PORTUGUESE	KB.I170A.034
	1	KEYBOARD 103KEYS NSK-ALA0J AC7T JV50 INTERNAL 17 STANDARD BLACK TEXTURE US-INTERNATIONAL	KB.I170A.056
	1	KEYBOARD 104KEYS NSK-ALA0J AC7T JV50 INTERNAL 17 STANDARD BLACK TEXTURE SLOVE	KB.I170A.049

Category	No.	Part Name & Description	Acer Part No.
<b>KEYBOARD</b>	1	KEYBOARD 104KEYS NSK-ALAOJ AC7T JV50 INTERNAL 17 STANDARD BLACK TEXTURE NORDIC	KB.I170A.045
	1	KEYBOARD 104KEYS NSK-ALAOJ AC7T JV50 INTERNAL 17 STANDARD BLACK TEXTURE FRENCH ARABIC	KB.I170A.038
	1	KEYBOARD 104KEYS NSK-ALAOJ AC7T JV50 INTERNAL 17 STANDARD BLACK TEXTURE FRENCH CANADIAN	KB.I170A.058
<b>LCD</b> 	1	CCFL LCD MODULE 15.6" WXGA GLARE BLUE W/ ANTENNA*2 W/O CAMERA (NONE 3G)	
	2	LCD AUO 15.6" WXGA GLARE LG LP156WH1-TLA1 LF 220NIT 8MS 400:1	LK.15608.001
	2	LCD AUO 15.6" WXGA GLARE CMO N156B3-L02 LF 220NIT 8MS	LK.1560D.001
	2	LCD AUO 15.6" WXGA GLARE AUO B156XW01 V0 LF 220NIT 8MS	LK.15605.001
	2	LCD SAMSUNG 15.6" W WXGA GLARE LTN156AT01-A01 LF 220NIT 8MS 600:1	LK.15606.001
	1	LED LCD MODULE 15.6" BLUE WXGA GLARE W/ ANTENNA*2 W/O CAMERA (NONE 3G)	
	2	LED LCD 15.6" WXGA GLARE AUO B156XW02 V0 LF 220NIT 8MS 500:1	LK.15605.003
	2	LED LCD 15.6" WXGA GLARE SAMSUNG LTN156AT02-A01 LF 220NIT 8MS 500:1	LK.15606.003
	2	LED LCD 15.6" WXGA GLARE LG LP156WH2-TLE1 LF 220NIT 8MS 400:1	LK.15608.002
	2	LED LCD CMO 15.6" W WXGA GLARE N156B6-L06 LF 220NIT 8MS 500:1	LK.1560D.007
	2	LED LCD INNOLUX 15.6" W WXGA GLARE BT156GW01 V2 LF 220NIT 8MS 600:1	LK.1560N.001
<b>MAINBOARD</b> 	1	MAINBOARD JV50_PU UMA RS880M SB710 LF W/RTC BATTERY&MODEM BOARD	55.4FN01.001G
<b>MEMORY</b> 	1	SODIMM 1GB DDRII667 SAMSUNG M470T2864QZ3-CE6 LF	KN.1GB0B.016
	1	SODIMM 1GB DDRII667 HYNIX HYMP112S64CP6-Y5 LF	KN.1GB0G.012
	1	SODIMM 1GB DDRII 800 NANYA NT1GT64UH8D0FN-AD LF 64*16 0.07UM	KN.1GB03.025
	1	SODIMM 1GB DDRII 800 SAMSUNG M470T2864EH3-CF7 LF 64*16 0.055UM	KN.1GB0B.033
	1	SODIMM 2GB DDRII667 HYNIX HYMP125S64CP8-Y5 LF	KN.2GB0G.004
	1	SODIMM 2GB DDRII667 SAMSUNG M470T5663QZ3-CE6 LF	KN.2GB0B.003
	1	SODIMM 2GB DDRII 800 NANYA NT2GT64U8HD0BN-AD LF 128*8 0.07UM	KN.2GB03.010
	1	SODIMM 2GB DDRII 800 ELPIDA EBE21UE8AFSA-8G-F LF 128*8 0.065UM	KN.2GB09.005
	1	SODIMM 2GB DDRII 800 SAMSUNG M470T5663EH3-CF7 LF 128*8 0.055UM	KN.2GB0B.018
<b>MICROPHONE</b>	2	MICROPHONE	23.42231.001
	2	MICROPHONE	23.40544.001
	2	MICROPHONE	23.42238.001
	2	MICROPHONE	23.42239.001
<b>MISCELLANEOUS</b>	2	LCD COVER SPONGE LEFT	47.PAT01.001

Category	No.	Part Name & Description	Acer Part No.
<b>MISCELLANEOUS</b>	2	LCD COVER SPONGE RIGHT	47.PAT01.002
	1	NAME PLATE AS5542	40.4FN07.001
	1	LCD SCREW RUBBER	47.AU401.001
<b>SCREWS</b>	1	SCREW M2.5X6 H=0.7~0.8MM	86.00E12.536
	1	SCREW M2X4	86.00E13.524
	1	SCREW M2.5*L8 NYLOK CR3+	86.00E34.738
	1	SCREW M2.5X10	86.1Z533.100
	1	SCREW M2X3	86.9A522.3R0
	1	SCREW M2*4 WAFER NI	86.9A552.4R0
	1	SCREW MACH WAFER M3*L4 NI	86.9A554.4R0
<b>SPEAKER</b>	2	SPEAKER ON LOWER CASE	23.PAW01.001
	2	SPEAKER ON UPPER CASE	23.PAW01.002

5. ACER\_ASPIRE 5542 UMACBB\_JV50\_TR (NO: LX.PHA02.002/3/17 )

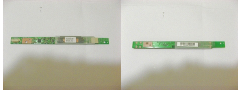

Category	No.	Part Name & Description	Acer Part No.	
<b>ADAPTER</b> 	1	ADAPTER 65W 19V 3PIN DELTA ADP-65JH DB A LV5 LED LF YELLOW	AP.06501.026	
	1	ADAPTER 65W 19V 3PIN LITEON PA-1650-22AC LV5 LED LF YELLOW	AP.06503.024	
	1	ADAPTER 65W 19V 3PIN HIPRO HP-A0652R3B 1LF LV5 LED LF YELLOW	AP.0650A.012	
<b>BATTERY</b> 	1	BATTERY SANYO AS-2007A LI-ION 3S2P SANYO 6 CELL 4400MAH MAIN COMMON NORMAL TYPE	BT.00603.041	
	1	BATTERY SONY AS-2007A LI-ION 3S2P SONY 6 CELL 4400MAH MAIN COMMON NORMAL TYPE	BT.00604.024	
	1	BATTERY PANASONIC AS-2007A LI-ION 3S2P PANASONIC 6 CELL 4400MAH MAIN COMMON PSS	BT.00605.020	
	1	BATTERY SIMPLO AS-2007A LI-ION 3S2P PANASONIC 6 CELL 4400MAH MAIN COMMON PSS	BT.00607.015	
	1	BATTERY SIMPLO AS-2007A LI-ION 3S2P LGC 6 CELL 4400MAH 2ND COMMON	BT.00607.019	
	1	BATTERY SIMPLO AS-2007A LI-ION 3S2P SAMSUNG 6 CELL 4400MAH MAIN COMMON SDI 2.2MAH F TYPE	BT.00607.034	
<b>BOARDS</b> 	1	BLUETOOTH BOARD FOXCONN BRM 2046 BT2.1 T60H928.33 F/W:861	BH.21100.004	
		2	INVERTER BOARD FOXCONN T62I240.03 V.00	19.AR501.002
		2	INVERTER BOARD YEC YNV-W15	19.AR501.001





Category	No.	Part Name & Description	Acer Part No.
<b>BOARDS</b> 	1	LED BUTTON BOARD	55.4FN03.001G
	2	MODEM BOARD LITEON CONEXANT -UNIZION 1.5_3.3V AUS B85247600G	FX.22500.021
	1	TOUCHPAD BOARD SYNAPTICS TM00540-005	56.ATR01.001
	1	TOUCHPAD BOARD ALPS KGDF0038A	56.PAW01.001
	1	TOUCH PAD BUTTON BOARD	55.PAW01.003
	1	USB BOARD	55.4FN02.001G
	1	WIRELESS LAN BOARD FOXCONN ATHEROS XB63 MINICARD B/G	NI.23600.046
	1	WIRELESS LAN BOARD QMI ATHEROS HB93 1X2 BGN HM EM306	NI.23600.054
	1	WIRELESS LAN BOARD 802.11BG FOXCONN T77H121.01 ATHEROS AR9285(HB95)	NI.23600.047
<b>CABLES</b>	1	BLUETOOTH BOARD CABLE	50.PAW01.004
	1	BLUETOOTH BOARD CALBE	50.ATR01.002
	2	CCFL LCD/CAMERA CABLE	50.PAT01.001
	1	FINGER PRINT / TP BUTTON BOARD CABLE	50.PAW01.003
	2	LED BUTTON BOARD CABLE	50.4CG02.001
	2	LED BUTTON BOARD CABLE	50.4CG02.011
	2	LED LCD/CAMERA CABLE	50.PAW01.005
	2	MODEM CABLE	50.4CG04.011
	2	MODEM CABLE	50.4CG04.001
	1	POWER CORD 10A 125V US	27.T30V1.001
	1	POWER CORD 10A 125V 3PIN US BK	27.01518.641
	1	POWER CORD 10A 250V ARGENTINE	27.01518.0U1
	1	POWER CORD 7A 250V 2PIN KOREAN	27.01518.531
	1	POWER CORD 3A 250V 3PIN UK	27.01518.541

Category	No.	Part Name & Description	Acer Part No.
<b>CABLES</b>	1	POWER CORD 5A 250V 3PIN UK BK	27.03118.001
	1	POWER CORD 7A 125V 2PIN JAPAN	27.01518.551
	1	POWER CORD 10A 3PIN BK DENMARK	27.01518.561
	1	POWER CORD 10A 250V 3PIN DENMARK BK	27.01518.671
	1	POWER CORD 10A 250V 3PIN BK SOUTH AFRICA	27.01518.571
	1	POWER CORD 16A 250V SOUTH AFRICA BK	27.01518.681
	1	POWER CORD 10A 250V SWISS	27.01518.581
	1	POWER CORD 10A 250V 3PIN SWISS BK	27.01518.691
	1	POWER CORD 10A 250V 3PIN CHINA	27.01518.591
	1	POWER CORD 10A 250V 3PIN CHINA BK	27.01518.701
	1	POWER CORD 250V 3PIN EUR BK	27.T30V1.004
	1	POWER CABLE 16A 250V 3PIN EUR BK	27.01518.731
	1	POWER CORD 10A 250V 3PIN ITALY	27.01518.611
	1	POWER CORD 10A 250V 3PIN ITALY BK	27.01518.711
	1	POWER CORD 2.5A 250V AUSTRALIA	27.01518.621
	1	POWER CORD 2.5A 250V SOUTH AFRICA BK (INDIA)	27.01518.631
	1	POWER CORD 10A 250V SOUTH AFRICA BK (INDIA)	27.01518.721
	1	POWER CORD 7A 125V 2PIN JAPAN BK	27.01518.661
	1	POWER CORD 250V 10A 3PIN ISRAEL	27.01518.761
	1	POWER CORD 2.5A 125V USA	27.01518.781
	1	POWER CORD 2.5A 125V 1.8M BLACK TAIWANESE	27.01518.A11
	1	POWER CORD 10A 250V 1.8M BRAZIL BLK	27.01518.A41
	1	POWER CORD ACA / ACNZ	27.03218.021
	1	POWER CORD 7.5A 250V 3P AUSTRALIA BK	27.03218.051
	1	POWER CODE 7A 125V 2PIN JAPAN	27.03518.161
	1	TOUCHPAD CABLE	50.PAW01.001
	1	TOUCHPAD CABLE	50.PAW01.001
	1	USB BOARD CABLE	50.PAW01.002
	1	USB BOARD CABLE	50.PAW01.002
	1	USB BOARD CABLE	50.PAW01.002
<b>CAMERA</b> 	2	CAMERA 0.3M SUYIN CN0314-SN30-OV03-5	57.N4401.001
	2	CAMERA 0.3M CHICONY CNF701721004973L	57.W9401.001
<b>CASE/COVER/ BRACKET ASSEMBLY</b> 	2	BLUE-RAY COMBO BEZEL	42.PAW01.005
	2	DVD-RW SUPER-MULTI BEZEL	42.PAW01.004

Category	No.	Part Name & Description	Acer Part No.
<b>CASE/COVER/ BRACKET ASSEMBLY</b> 	2	HDD BRACKET	33.PAW01.003
	2	LCD BEZEL 15.6" W/CAMERA HOLE	60.PAW01.004
	2	LCD BRACKET W/HINGE LEFT	33.PAW01.006
	2	LCD BRACKET W/HINGE RIGHT	33.ATR01.004
	2	LCD COVER IMR 15.6" BLUE W/ANTENNA*2 & LOGO	60.PEZ01.001
	2	LED LCD BRACKET LEFT W/HINGE	33.PAW01.004
	2	LED LCD BRACKET RIGHT W/HINGE	33.PAW01.005
	1	LOWER CASE W/MODEM CABLE&SPEAKER	60.PAW01.001
	1	MIDDLE COVER W/BLUETOOTH BUTTON WITH BLUE LIGHT NONE 3G BUTTON	42.PAW01.001
	2	OPTICAL BRACKET	33.PAW01.002
	1	SD DUMMY CARD	42.TKJ01.001
	1	TOUCHPAD BRACKET	33.PAW01.001
	1	UNITLOAD COVER	42.PAW01.002
	1	UPPER CASE BLUE W/LED BUTTON BOARD CABLE&MICROPHONE&SPEAKER W/O FINGER PRINT HOLE	60.PAW01.002



Category	No.	Part Name & Description	Acer Part No.
<b>CASE/COVER/ BRACKET ASSEMBLY</b> 	1	WIRELESS LAN COVER	42.PAW01.003
	1	BLU-RAY COMBO MODULE 4X SATA FOR WINDOWS7	
<b>COMBO MODULE</b>	2	ODD PIONEER BD COMBO 12.7MM TRAY DL 4X SATA BDC-TD01RS LF W/O BEZEL FOR WINDOWS7	KO.00405.003
	2	ODD PLDS BD COMBO 12.7MM TRAY DL 4X DS-4E1S LF W/O BEZEL SATA FOR WINDOWS7	KO.0040F.003
	1	CPU AMD ATHLONII M300 2.0G 1M 35W CASPIAN	KC.AM002.300
<b>CPU/PROCESSOR</b> 	1	CPU AMD ATHLONII M320 2.1G 1M 35W CASPIAN	KC.AM002.320
	1	CPU AMD SEMPRONM M100 2.0G 512K 25W CASPIAN	KC.SM002.100
	1	CPU AMD TURIONII M500 2.2G 1M 35W	KC.TM002.500
	1	CPU AMD TURIONII M520 2.3G 1M 35W	KC.TM002.520
	1	CPU AMD TURION M600 2.4G 2M 35W CASPIAN	KC.TM002.600
	1	CPU AMD TURION M620 2.5G 2M 35W CASPIAN	KC.TM002.620
	1	CPU AMD TURION M640 2.6G 2M 35W CASPIAN	KC.TM002.640
	1	DVD-RW SUPER-MULTI MODULE 8X SATA FOR WINDOWS7	
<b>DVD-RW DRIVE</b>	2	ODD HLDS SUPER-MULTI DRIVE 12.7MM TRAY DL 8X GT30N LF W/O BEZEL SATA FOR HF+WINDOWS7	KU.0080D.048
	2	ODD TOSHIBA SUPER-MULTI DRIVE 12.7MM TRAY DL 8X TS-L633C LF W/O BEZEL SATA FOR HF+WINDOWS7	KU.00801.035
	2	ODD PANASONIC SUPER-MULTI DRIVE 12.7MM TRAY DL 8X UJ890A LF W/O BEZEL SATA HF+WINDOWS 7	KU.00807.070
	1	HDD MODULE 160GB 5400RPM SATA	
<b>HDD/HARD DISK DRIVE</b> 	2	HDD 160GB 5400RPM 2.5" SATA WYATT SEAGATE ST9160314AS F/W:0001SDM1	KH.16001.042
	2	HDD 160GB 5400RPM SATA TOSHIBA LIBRA-BS MK1655GSX F/W:FG0101J 5.4	KH.16004.006
	2	HDD 160GB 5400RPM SATA HGST PANTHER-B PANTHER-B HTS545016B9A300 F/W:C60F	KH.16007.024
	2	HDD 160GB 5400RPM 2.5" SATA WD WD1600BEVT-22ZCT0 FW:11.01A11	KH.16008.022
	1	HDD MODULE 250GB 5400RPM SATA	
	2	HDD 2.5" 5400RPM 250GB SEAGATE ST9250315AS WYATT SATA LF F/W:0001SDM1	KH.25001.016
	2	HDD 250GB 5400RPM SATA TOSHIBA LIBRA-BS MK2555GSX F/W:FG000J 5.4K	KH.25004.003
	2	HDD 250GB 5400RPM SATA HGST HTS545025B9A300 PANTHER-B LF	KH.25007.015
	2	HDD 250GB 5400RPM SATA WD WD2500BEVT-22ZCT0 F/W:11.01A11	KH.25008.021
	1	HDD MODULE 320GB 5400RPM SATA	
	2	HDD 320GB 5400RPM SATA SEAGATE WYATT ST9320325AS FW:0001SDM1	KH.32001.017
	2	HDD 320GB 5400RPM SATA TOSHIBA MK3255GSX LIBRA LF F/W:FG010J	KH.32004.002
	2	HDD 320GB 5400RPM SATA HGST HTS545032B9A300 PANTHER B LF	KH.32007.007

Category	No.	Part Name & Description	Acer Part No.
<b>HDD/HARD DISK DRIVE</b>	2	HDD 320GB 5400RPM SATA WD WD3200BEVT-22ZCT0 ML125 F/W:01.01A01	KH.32008.013
	1	HDD MODULE 500GB 5400RPM SATA	
	2	HDD 500GB 5400RPM HGST SATA HTS545050B9A300 PANTHER B LF	KH.50007.009
	2	HDD 500GB 5400RPM SEAGATE ST9500325AS SATA LF F/W:0001SDM1	KH.50001.011
	2	HDD 2.5" 5400RPM 500GB TOSHIBA MK5055GSX LIBRA SATA LF F/W:FG001J	KH.50004.001
	2	HDD 500GB 5400RPM WD SATA WD5000BEVT-22ZAT0 F/W:01.01A01	KH.50008.013
<b>HEATSINK</b> 	1	CPU HEATSINK UMA W/FAN	60.4FN03.001
	1	CPU HEATSINK UMA W/FAN	60.4FN05.001
	1	CPU HEATSINK UMA W/FAN	60.4FN07.001
<b>KEYBOARD</b> 	1	KEYBOARD 104KEYS NSK-ALA0J AC7T JV50 INTERNAL 17 STANDARD BLACK TEXTURE UK	KB.1170A.055
	1	KEYBOARD 104KEYS NSK-ALA0J AC7T JV50 INTERNAL 17 STANDARD BLACK TEXTURE SWISS	KB.1170A.052
	1	KEYBOARD 103KEYS NSK-ALA0J AC7T JV50 INTERNAL 17 STANDARD BLACK TEXTURE TAIWAN	KB.1170A.036
	1	KEYBOARD 103KEYS NSK-ALA0J AC7T JV50 INTERNAL 17 STANDARD BLACK TEXTURE THAILAND	KB.1170A.053
	1	KEYBOARD 104KEYS NSK-ALA0J AC7T JV50 INTERNAL 17 STANDARD BLACK TEXTURE PORTUGAL	KB.1170A.047
	1	KEYBOARD 103KEYS NSK-ALA0J AC7T JV50 INTERNAL 17 STANDARD BLACK TEXTURE ARABIC	KB.1170A.032
	1	KEYBOARD 104KEYS NSK-ALA0J AC7T JV50 INTERNAL 17 STANDARD BLACK TEXTURE DANISH	KB.1170A.037
	1	KEYBOARD 104KEYS NSK-ALA0J AC7T JV50 INTERNAL 17 STANDARD BLACK TEXTURE ITALIAN	KB.1170A.043
	1	KEYBOARD 104KEYS NSK-ALA0J AC7T JV50 INTERNAL 17 STANDARD BLACK TEXTURE FRENCH	KB.1170A.039
	1	KEYBOARD 104KEYS NSK-ALA0J AC7T JV50 INTERNAL 17 STANDARD BLACK TEXTURE GERMAN	KB.1170A.040
	1	KEYBOARD 103KEYS NSK-ALA0J AC7T JV50 INTERNAL 17 STANDARD BLACK TEXTURE HEBREW	KB.1170A.057
	1	KEYBOARD 107KEYS NSK-ALA0J AC7T JV50 INTERNAL 17 STANDARD BLACK TEXTURE JAPANESE	KB.1170A.044
	1	KEYBOARD 103KEYS NSK-ALA0J AC7T JV50 INTERNAL 17 STANDARD BLACK TEXTURE GREEK	KB.1170A.041
	1	KEYBOARD 104KEYS NSK-ALA0J AC7T JV50 INTERNAL 17 STANDARD BLACK TEXTURE NORWEGIAN	KB.1170A.046
	1	KEYBOARD 104KEYS NSK-ALA0J AC7T JV50 INTERNAL 17 STANDARD BLACK TEXTURE HUNGARIAN	KB.1170A.042
	1	KEYBOARD 103KEYS NSK-ALA0J AC7T JV50 INTERNAL 17 STANDARD BLACK TEXTURE RUSSIAN	KB.1170A.048
	1	KEYBOARD 104KEYS NSK-ALA0J AC7T JV50 INTERNAL 17 STANDARD BLACK TEXTURE SPANISH	KB.1170A.050
	1	KEYBOARD 104KEYS NSK-ALA0J AC7T JV50 INTERNAL 17 STANDARD BLACK TEXTURE SPANISH	KB.1170A.050
	1	KEYBOARD 104KEYS NSK-ALA0J AC7T JV50 INTERNAL 17 STANDARD BLACK TEXTURE TURKISH	KB.1170A.054

Category	No.	Part Name & Description	Acer Part No.	
<b>KEYBOARD</b>	1	KEYBOARD 104KEYS NSK-ALA0J AC7T JV50 INTERNAL 17 STANDARD BLACK TEXTURE SWEDISH	KB.I170A.051	
	1	KEYBOARD 104KEYS NSK-ALA0J AC7T JV50 INTERNAL 17 STANDARD BLACK TEXTURE CZECH/SLOVAK	KB.I170A.035	
	1	KEYBOARD 104KEYS NSK-ALA0J AC7T JV50 INTERNAL 17 STANDARD BLACK TEXTURE BELGIAN	KB.I170A.033	
	1	KEYBOARD 104KEYS NSK-ALA0J AC7T JV50 INTERNAL 17 STANDARD BLACK TEXTURE BRAZILIAN PORTUGUESE	KB.I170A.034	
	1	KEYBOARD 103KEYS NSK-ALA0J AC7T JV50 INTERNAL 17 STANDARD BLACK TEXTURE US-INTERNATIONAL	KB.I170A.056	
	1	KEYBOARD 104KEYS NSK-ALA0J AC7T JV50 INTERNAL 17 STANDARD BLACK TEXTURE SLOVE	KB.I170A.049	
	1	KEYBOARD 104KEYS NSK-ALA0J AC7T JV50 INTERNAL 17 STANDARD BLACK TEXTURE NORDIC	KB.I170A.045	
	1	KEYBOARD 104KEYS NSK-ALA0J AC7T JV50 INTERNAL 17 STANDARD BLACK TEXTURE FRENCH ARABIC	KB.I170A.038	
	1	KEYBOARD 104KEYS NSK-ALA0J AC7T JV50 INTERNAL 17 STANDARD BLACK TEXTURE FRENCH CANADIAN	KB.I170A.058	
	<b>LCD</b> 	1	LED LCD MODULE 15.6" BLUE WXGA GLARE W/ ANTENNA*2&CAMERA (NONE 3G)	
2		LED LCD 15.6" WXGA GLARE AUO B156XW02 V0 LF 220NIT 8MS 500:1	LK.15605.003	
2		LED LCD 15.6" WXGA GLARE SAMSUNG LTN156AT02-A01 LF 220NIT 8MS 500:1	LK.15606.003	
2		LED LCD 15.6" WXGA GLARE LG LP156WH2-TLE1 LF 220NIT 8MS 400:1	LK.15608.002	
2		LED LCD CMO 15.6" W WXGA GLARE N156B6-L06 LF 220NIT 8MS 500:1	LK.1560D.007	
2		LED LCD INNOLUX 15.6" W WXGA GLARE BT156GW01 V2 LF 220NIT 8MS 600:1	LK.1560N.001	
1		CCFL LCD MODULE 15.6" WXGA GLARE BLUE W/ ANTENNA*2&CAMERA (NONE 3G)		
2		LCD AUO 15.6" WXGA GLARE AUO B156XW01 V0 LF 220NIT 8MS	LK.15605.001	
2		LCD SAMSUNG 15.6" W WXGA GLARE LTN156AT01-A01 LF 220NIT 8MS 600:1	LK.15606.001	
2		LCD AUO 15.6" WXGA GLARE LG LP156WH1-TLA1 LF 220NIT 8MS 400:1	LK.15608.001	
2		LCD AUO 15.6" WXGA GLARE CMO N156B3-L02 LF 220NIT 8MS	LK.1560D.001	
<b>MAINBOARD</b> 		1	MAINBOARD JV50_PU UMA RS880M SB710 LF W/RTC BATTERY&MODEM BOARD	55.4FN01.001G
<b>MEMORY</b> 		1	SODIMM 1GB DDRII667 SAMSUNG M470T2864QZ3-CE6 LF	KN.1GB0B.016
	1	SODIMM 1GB DDRII667 HYNIX HYMP112S64CP6-Y5 LF	KN.1GB0G.012	
	1	SODIMM 1GB DDRII 800 NANYA NT1GT64UH8D0FN-AD LF 64*16 0.07UM	KN.1GB03.025	
	1	SODIMM 1GB DDRII 800 SAMSUNG M470T2864EH3-CF7 LF 64*16 0.055UM	KN.1GB0B.033	
	1	SODIMM 2GB DDRII667 HYNIX HYMP125S64CP8-Y5 LF	KN.2GB0G.004	



Category	No.	Part Name & Description	Acer Part No.
<b>MEMORY</b>	1	SODIMM 2GB DDRII667 SAMSUNG M470T5663QZ3-CE6 LF	KN.2GB0B.003
	1	SODIMM 2GB DDRII 800 NANYA NT2GT64U8HD0BN-AD LF 128*8 0.07UM	KN.2GB03.010
	1	SODIMM 2GB DDRII 800 ELPIDA EBE21UE8AFSA-8G-F LF 128*8 0.065UM	KN.2GB09.005
	1	SODIMM 2GB DDRII 800 SAMSUNG M470T5663EH3-CF7 LF 128*8 0.055UM	KN.2GB0B.018
<b>MICROPHONE</b>	2	MICROPHONE	23.42231.001
	2	MICROPHONE	23.40544.001
	2	MICROPHONE	23.42238.001
	2	MICROPHONE	23.42239.001
<b>MISCELLANEOUS</b>	2	LCD COVER SPONGE LEFT	47.PAT01.001
	2	LCD COVER SPONGE RIGHT	47.PAT01.002
	1	LCD SCREW RUBBER	47.AU401.001
	1	NAME PLATE AS5542	40.4FN07.001
<b>SCREWS</b>	1	SCREW M2.5X6	86.00E12.536
	1	SCREW M2X4	86.00E13.524
	1	SCREW M2.5*L8 NYLOK CR3+	86.00E34.738
	1	SCREW M2.5X10	86.1Z533.100
	1	SCREW M2X3	86.9A522.3R0
	1	SCREW M2*4 WAFER NI	86.9A552.4R0
	1	SCREW MACH WAFER M3*L4 NI	86.9A554.4R0
<b>SPEAKER</b>	2	SPEAKER ON LOWER CASE	23.PAW01.001
	2	SPEAKER ON UPPER CASE	23.PAW01.002

6. ACER\_ASPIRE 5542G M92XT512Cbb V3\_JV50\_TR(NO: LX.PHP02.018/48 )

Category	No.	Part Name & Description	Acer Part No.
<b>ADAPTER</b> 	1	ADAPTER 90W 19V 3PIN DELTA ADP-90CD DB A LV5 LED LF BLUE	AP.09001.027
	1	ADPAPTER 90W 19V 3PIN LITEON PA-1900-34AR LV5 LED LF BLUE	AP.09003.021
	1	ADPAPTER 90W 19V 3PIN HIPRO HP-A0904A3 B1LF LV5 LED LF BLUE	AP.0900A.005
<b>BATTERY</b> 	1	BATTERY SANYO AS-2007A LI-ION 3S2P SANYO 6 CELL 4400MAH MAIN COMMON NORMAL TYPE	BT.00603.041
	1	BATTERY SONY AS-2007A LI-ION 3S2P SONY 6 CELL 4400MAH MAIN COMMON NORMAL TYPE	BT.00604.024
	1	BATTERY PANASONIC AS-2007A LI-ION 3S2P PANASONIC 6 CELL 4400MAH MAIN COMMON PSS	BT.00605.020
	1	BATTERY SIMPLO AS-2007A LI-ION 3S2P PANASONIC 6 CELL 4400MAH MAIN COMMON PSS	BT.00607.015
	1	BATTERY SIMPLO AS-2007A LI-ION 3S2P LGC 6 CELL 4400MAH 2ND COMMON	BT.00607.019
	1	BATTERY SIMPLO AS-2007A LI-ION 3S2P SAMSUNG 6 CELL 4400MAH MAIN COMMON SDI 2.2MAH F TYPE	BT.00607.034

Category	No.	Part Name & Description	Acer Part No.
<b>BOARDS</b> 	1	BLUETOOTH BOARD FOXCONN BRM 2046 BT2.1 T60H928.33 F/W:861	BH.21100.004
		2	INVERTER BOARD FOXCONN T62I240.03 V.00
	2	INVERTER BOARD YEC YNV-W15	19.AR501.001
	1	LED BUTTON BOARD	55.4FN03.001G
	2	MODEM BOARD LITEON CONEXANT -UNIZION 1.5_3.3V AUS B85247600G	FX.22500.021
	1	TOUCH PAD BUTTON BOARD	55.PAW01.003
	1	TOUCHPAD BOARD SYNAPTICS TM00540-005	56.ATR01.001
	1	TOUCHPAD BOARD ALPS KGDF0038A	56.PAW01.001
	1	USB BOARD	55.4FN02.001G
	1	WIRELESS LAN BOARD FOXCONN ATHEROS XB63 MINICARD B/G	NI.23600.046
	1	WIRELESS LAN BOARD QMI ATHEROS HB93 1X2 BGN HM EM306	NI.23600.054
	1	WIRELESS LAN BOARD 802.11BG FOXCONN T77H121.01 ATHEROS AR9285(HB95)	NI.23600.047
<b>CABLES</b>	1	BLUETOOTH BOARD CABLE	50.ATR01.002
	1	BLUETOOTH BOARD CABLE	50.PAW01.004
	2	CCFL LCD/CAMERA CABLE	50.PAT01.001
	1	FINGER PRINT / TP BUTTON BOARD CABLE	50.PAW01.003
	2	LED BUTTON BOARD CABLE	50.4CG02.001
	2	LED BUTTON BOARD CABLE	50.4CG02.011
	2	LED LCD/CAMERA CABLE	50.PAW01.005

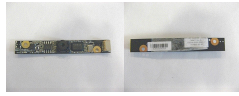
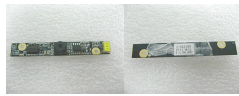

Category	No.	Part Name & Description	Acer Part No.
<b>CABLES</b>	2	MODEM CABLE	50.4CG04.011
	2	MODEM CABLE	50.4CG04.001
	1	POWER CORD 3A 250V 3PIN UK	27.01518.541
	1	POWER CORD 5A 250V 3PIN UK BK	27.03118.001
	1	POWER CORD 10A 125V US	27.T30V1.001
	1	POWER CORD 10A 125V 3PIN US BK	27.01518.641
	1	POWER CORD 10A 250V ARGENTINE	27.01518.0U1
	1	POWER CORD 7A 250V 2PIN KOREAN	27.01518.531
	1	POWER CORD 7A 125V 2PIN JAPAN	27.01518.551
	1	POWER CORD 10A 3PIN BK DENMARK	27.01518.561
	1	POWER CORD 10A 250V 3PIN DENMARK BK	27.01518.671
	1	POWER CORD 10A 250V 3PIN BK SOUTH AFRICA	27.01518.571
	1	POWER CORD 16A 250V SOUTH AFRICA BK	27.01518.681
	1	POWER CORD 10A 250V SWISS	27.01518.581
	1	POWER CORD 10A 250V 3PIN SWISS BK	27.01518.691
	1	POWER CORD 10A 250V 3PIN CHINA	27.01518.591
	1	POWER CORD 10A 250V 3PIN CHINA BK	27.01518.701
	1	POWER CORD 250V 3PIN EUR BK	27.T30V1.004
	1	POWER CABLE 16A 250V 3PIN EUR BK	27.01518.731
	1	POWER CORD 10A 250V 3PIN ITALY	27.01518.611
	1	POWER CORD 10A 250V 3PIN ITALY BK	27.01518.711
	1	POWER CORD 2.5A 250V AUSTRALIA	27.01518.621
	1	POWER CORD 2.5A 250V SOUTH AFRICA BK (INDIA)	27.01518.631
	1	POWER CORD 10A 250V SOUTH AFRICA BK (INDIA)	27.01518.721
	1	POWER CORD 7A 125V 2PIN JAPAN BK	27.01518.661
	1	POWER CORD 250V 10A 3PIN ISRAEL	27.01518.761
	1	POWER CORD 2.5A 125V USA	27.01518.781
	1	POWER CORD 2.5A 125V 1.8M BLACK TAIWANESE	27.01518.A11
	1	POWER CORD 10A 250V 1.8M BRAZIL BLK	27.01518.A41
	1	POWER CORD ACA / ACNZ	27.03218.021
	1	POWER CORD 7.5A 250V 3P AUSTRALIA BK	27.03218.051
	1	POWER CODE 7A 125V 2PIN JAPAN	27.03518.161
	1	TOUCHPAD CABLE	50.PAW01.001
1	USB BOARD CABLE	50.PAW01.002	
<b>CAMERA</b>	2	CAMERA 0.3M SUYIN CN0314-SN30-OV03-5	57.N4401.001
	2	CAMERA 0.3M CHICONY CNF701721004973L	57.W9401.001
			
<b>CASE/COVER/ BRACKET ASSEMBLY</b>	2	BLUE-RAY COMBO BEZEL	42.PAW01.005
			

Category	No.	Part Name & Description	Acer Part No.
<b>CASE/COVER/ BRACKET ASSEMBLY</b>	2	DVD-RW SUPER-MULTI BEZEL	42.PAW01.004
	2	HDD BRACKET	33.PAW01.003
	2	LCD BEZEL 15.6" W/CAMERA HOLE	60.PAW01.004
	2	LCD BRACKET W/HINGE LEFT	33.PAW01.006
	2	LCD BRACKET W/HINGE RIGHT	33.ATR01.004
	2	LCD COVER IMR 15.6" BLUE W/ANTENNA*2 & LOGO	60.PEZ01.001
	2	LED LCD BRACKET RIGHT W/HINGE	33.PAW01.005
	2	LED LCD BRACKET LEFT W/HINGE	33.PAW01.004
	1	LOWER CASE W/MODEM CABLE&SPEAKER	60.PAW01.001
	1	MIDDLE COVER W/BLUETOOTH BUTTON WITH BLUE LIGHT NONE 3G BUTTON	42.PAW01.001
	2	OPTICAL BRACKET	33.PAW01.002
	1	SD DUMMY CARD	42.TKJ01.001
	1	TOUCHPAD BRACKET	33.PAW01.001
	1	UNITLOAD COVER	42.PAW01.002
	1	UPPER CASE BLUE W/LED BUTTON BOARD CABLE&MICROPHONE&SPEAKER W/O FINGER PRINT HOLE	60.PAW01.002

Category	No.	Part Name & Description	Acer Part No.
<b>CASE/COVER/ BRACKET ASSEMBLY</b> 	1	WIRELESS LAN COVER	42.PAW01.003
	1	BLU-RAY COMBO MODULE 4X SATA FOR WINDOWS7	
<b>COMBO MODULE</b> 	2	ODD PIONEER BD COMBO 12.7MM TRAY DL 4X SATA BDC-TD01RS LF W/O BEZEL FOR WINDOWS7	KO.00405.003
	2	ODD PLDS BD COMBO 12.7MM TRAY DL 4X DS-4E1S LF W/O BEZEL SATA FOR WINDOWS7	KO.0040F.003
<b>CPU/PROCESSOR</b> 	1	CPU AMD ATHLONII M300 2.0G 1M 35W CASPIAN	KC.AM002.300
	1	CPU AMD ATHLONII M320 2.1G 1M 35W CASPIAN	KC.AM002.320
	1	CPU AMD SEMPRONM M100 2.0G 512K 25W CASPIAN	KC.SM002.100
	1	CPU AMD TURIONII M500 2.2G 1M 35W	KC.TM002.500
	1	CPU AMD TURIONII M520 2.3G 1M 35W	KC.TM002.520
	1	CPU AMD TURION M600 2.4G 2M 35W CASPIAN	KC.TM002.600
	1	CPU AMD TURION M620 2.5G 2M 35W CASPIAN	KC.TM002.620
	1	CPU AMD TURION M640 2.6G 2M 35W CASPIAN	KC.TM002.640
<b>DVD-RW DRIVE</b>	1	DVD-RW SUPER-MULTI MODULE 8X SATA FOR WINDOWS7	
	2	ODD HLDS SUPER-MULTI DRIVE 12.7MM TRAY DL 8X GT30N LF W/O BEZEL SATA FOR HF+WINDOWS7	KU.0080D.048
	2	ODD TOSHIBA SUPER-MULTI DRIVE 12.7MM TRAY DL 8X TS-L633C LF W/O BEZEL SATA FOR HF+WINDOWS7	KU.00801.035
	2	ODD PANASONIC SUPER-MULTI DRIVE 12.7MM TRAY DL 8X UJ890A LF W/O BEZEL SATA HF+WINDOWS 7	KU.00807.070
<b>HDD/HARD DISK DRIVE</b> 	1	HDD MODULE 160GB 5400RPM SATA	
	2	HDD 160GB 5400RPM 2.5" SATA WYATT SEAGATE ST9160314AS F/W:0001SDM1	KH.16001.042
	2	HDD 160GB 5400RPM SATA TOSHIBA LIBRA-BS MK1655GSX F/W:FG0101J 5.4	KH.16004.006
	2	HDD 160GB 5400RPM SATA HGST PANTHER-B PANTHER-B HTS545016B9A300 F/W:C60F	KH.16007.024
	2	HDD 160GB 5400RPM 2.5" SATA WD WD1600BEVT-22ZCT0 FW:11.01A11	KH.16008.022
	1	HDD MODULE 250GB 5400RPM SATA	
	2	HDD 2.5" 5400RPM 250GB SEAGATE ST9250315AS WYATT SATA LF F/W:0001SDM1	KH.25001.016
	2	HDD 250GB 5400RPM SATA TOSHIBA LIBRA-BS MK2555GSX F/W:FG000J 5.4K	KH.25004.003
	2	HDD 250GB 5400RPM SATA HGST HTS545025B9A300 PANTHER-B LF	KH.25007.015
	2	HDD 250GB 5400RPM SATA WD WD2500BEVT-22ZCT0 F/W:11.01A11	KH.25008.021
	1	HDD MODULE 320GB 5400RPM SATA	
	2	HDD 320GB 5400RPM SATA HGST HTS545032B9A300 PANTHER B LF	KH.32007.007
	2	HDD 320GB 5400RPM SATA SEAGATE WYATT ST9320325AS FW:0001SDM1	KH.32001.017
	2	HDD 320GB 5400RPM SATA TOSHIBA MK3255GSX LIBRA LF F/W:FG010J	KH.32004.002

Category	No.	Part Name & Description	Acer Part No.
<b>HDD/HARD DISK DRIVE</b>	2	HDD 320GB 5400RPM SATA WD WD3200BEVT-22ZCT0 ML125 F/W:01.01A01	KH.32008.013
	2	HDD 500GB 5400RPM HGST SATA HTS545050B9A300 PANTHER B LF	KH.50007.009
	2	HDD 500GB 5400RPM SEAGATE ST9500325AS SATA LF F/W:0001SDM1	KH.50001.011
	2	HDD 2.5" 5400RPM 500GB TOSHIBA MK5055GSX LIBRA SATA LF F/W:FG001J	KH.50004.001
	2	HDD 500GB 5400RPM WD SATA WD5000BEVT-22ZAT0 F/W:01.01A01	KH.50008.013
<b>HEATSINK</b> 	1	CPU HEATSINK DISCRETE W/FAN	60.4FN02.001
	1	CPU HEATSINK DISCRETE W/FAN	60.4FN04.001
	1	CPU HEATSINK DISCRETE W/FAN	60.4FN06.001
<b>KEYBOARD</b> 	1	KEYBOARD 104KEYS NSK-ALA0J AC7T JV50 INTERNAL 17 STANDARD BLACK TEXTURE UK	KB.I170A.055
	1	KEYBOARD 104KEYS NSK-ALA0J AC7T JV50 INTERNAL 17 STANDARD BLACK TEXTURE SWISS	KB.I170A.052
	1	KEYBOARD 103KEYS NSK-ALA0J AC7T JV50 INTERNAL 17 STANDARD BLACK TEXTURE TAIWAN	KB.I170A.036
	1	KEYBOARD 103KEYS NSK-ALA0J AC7T JV50 INTERNAL 17 STANDARD BLACK TEXTURE THAILAND	KB.I170A.053
	1	KEYBOARD 104KEYS NSK-ALA0J AC7T JV50 INTERNAL 17 STANDARD BLACK TEXTURE PORTUGAL	KB.I170A.047
	1	KEYBOARD 103KEYS NSK-ALA0J AC7T JV50 INTERNAL 17 STANDARD BLACK TEXTURE ARABIC	KB.I170A.032
	1	KEYBOARD 104KEYS NSK-ALA0J AC7T JV50 INTERNAL 17 STANDARD BLACK TEXTURE DANISH	KB.I170A.037
	1	KEYBOARD 104KEYS NSK-ALA0J AC7T JV50 INTERNAL 17 STANDARD BLACK TEXTURE ITALIAN	KB.I170A.043
	1	KEYBOARD 104KEYS NSK-ALA0J AC7T JV50 INTERNAL 17 STANDARD BLACK TEXTURE FRENCH	KB.I170A.039
	1	KEYBOARD 104KEYS NSK-ALA0J AC7T JV50 INTERNAL 17 STANDARD BLACK TEXTURE GERMAN	KB.I170A.040
	1	KEYBOARD 103KEYS NSK-ALA0J AC7T JV50 INTERNAL 17 STANDARD BLACK TEXTURE HEBREW	KB.I170A.057
	1	KEYBOARD 103KEYS NSK-ALA0J AC7T JV50 INTERNAL 17 STANDARD BLACK TEXTURE HEBREW	KB.I170A.057
	1	KEYBOARD 107KEYS NSK-ALA0J AC7T JV50 INTERNAL 17 STANDARD BLACK TEXTURE JAPANESE	KB.I170A.044
	1	KEYBOARD 107KEYS NSK-ALA0J AC7T JV50 INTERNAL 17 STANDARD BLACK TEXTURE JAPANESE	KB.I170A.044
	1	KEYBOARD 103KEYS NSK-ALA0J AC7T JV50 INTERNAL 17 STANDARD BLACK TEXTURE GREEK	KB.I170A.041
	1	KEYBOARD 103KEYS NSK-ALA0J AC7T JV50 INTERNAL 17 STANDARD BLACK TEXTURE GREEK	KB.I170A.041
	1	KEYBOARD 104KEYS NSK-ALA0J AC7T JV50 INTERNAL 17 STANDARD BLACK TEXTURE NORWEGIAN	KB.I170A.046
	1	KEYBOARD 104KEYS NSK-ALA0J AC7T JV50 INTERNAL 17 STANDARD BLACK TEXTURE NORWEGIAN	KB.I170A.046

Category	No.	Part Name & Description	Acer Part No.
<b>KEYBOARD</b>	1	KEYBOARD 104KEYS NSK-ALA0J AC7T JV50 INTERNAL 17 STANDARD BLACK TEXTURE HUNGARIAN	KB.I170A.042
	1	KEYBOARD 103KEYS NSK-ALA0J AC7T JV50 INTERNAL 17 STANDARD BLACK TEXTURE RUSSIAN	KB.I170A.048
	1	KEYBOARD 104KEYS NSK-ALA0J AC7T JV50 INTERNAL 17 STANDARD BLACK TEXTURE SPANISH	KB.I170A.050
	1	KEYBOARD 104KEYS NSK-ALA0J AC7T JV50 INTERNAL 17 STANDARD BLACK TEXTURE TURKISH	KB.I170A.054
	1	KEYBOARD 104KEYS NSK-ALA0J AC7T JV50 INTERNAL 17 STANDARD BLACK TEXTURE SWEDISH	KB.I170A.051
	1	KEYBOARD 104KEYS NSK-ALA0J AC7T JV50 INTERNAL 17 STANDARD BLACK TEXTURE CZECH/ SLOVAK	KB.I170A.035
	1	KEYBOARD 104KEYS NSK-ALA0J AC7T JV50 INTERNAL 17 STANDARD BLACK TEXTURE BELGIAN	KB.I170A.033
	1	KEYBOARD 104KEYS NSK-ALA0J AC7T JV50 INTERNAL 17 STANDARD BLACK TEXTURE BRAZILIAN PORTUGUESE	KB.I170A.034
	1	KEYBOARD 103KEYS NSK-ALA0J AC7T JV50 INTERNAL 17 STANDARD BLACK TEXTURE US- INTERNATIONAL	KB.I170A.056
	1	KEYBOARD 104KEYS NSK-ALA0J AC7T JV50 INTERNAL 17 STANDARD BLACK TEXTURE SLOVE	KB.I170A.049
	1	KEYBOARD 104KEYS NSK-ALA0J AC7T JV50 INTERNAL 17 STANDARD BLACK TEXTURE NORDIC	KB.I170A.045
	1	KEYBOARD 104KEYS NSK-ALA0J AC7T JV50 INTERNAL 17 STANDARD BLACK TEXTURE FRENCH ARABIC	KB.I170A.038
	1	KEYBOARD 104KEYS NSK-ALA0J AC7T JV50 INTERNAL 17 STANDARD BLACK TEXTURE FRENCH CANADIAN	KB.I170A.058
<b>LCD</b> 	1	LED LCD MODULE 15.6" BLUE WXGA GLARE W/ ANTENNA*2&CAMERA (NONE 3G)	
	2	LED LCD 15.6" WXGA GLARE AUO B156XW02 V0 LF 220NIT 8MS 500:1	LK.15605.003
	2	LED LCD 15.6" WXGA GLARE SAMSUNG LTN156AT02- A01 LF 220NIT 8MS 500:1	LK.15606.003
	2	LED LCD 15.6" WXGA GLARE LG LP156WH2-TLE1 LF 220NIT 8MS 400:1	LK.15608.002
	2	LED LCD CMO 15.6" W WXGA GLARE N156B6-L06 LF 220NIT 8MS 500:1	LK.1560D.007
	2	LED LCD INNOLUX 15.6" W WXGA GLARE BT156GW01 V2 LF 220NIT 8MS 600:1	LK.1560N.001
	1	CCFL LCD MODULE 15.6" WXGA GLARE BLUE W/ ANTENNA*2&CAMERA (NONE 3G)	
	2	LCD AUO 15.6" WXGA GLARE AUO B156XW01 V0 LF 220NIT 8MS	
	2	LCD SAMSUNG 15.6" W WXGA GLARE LTN156AT01-A01 LF 220NIT 8MS 600:1	LK.15606.001
	2	LCD AUO 15.6" WXGA GLARE LG LP156WH1-TLA1 LF 220NIT 8MS 400:1	LK.15608.001
	2	LCD AUO 15.6" WXGA GLARE CMO N156B3-L02 LF 220NIT 8MS	LK.1560D.001

Category	No.	Part Name & Description	Acer Part No.
<b>MAINBOARD</b> 	1	MAINBOARD AS5542G ATI RS880MN SB710 M92M-XT 512MB LF W/RTC BATTERY&MODEM BOARD	55.4FN01.011G
	1	MAINBOARD AS5542G ATI RS880MN SB710 M92M-XT 512MB LF W/RTC BATTERY&MODEM BOARD	55.4FN01.021G
<b>MEMORY</b> 	1	SODIMM 1GB DDRII667 SAMSUNG M470T2864QZ3-CE6 LF	KN.1GB0B.016
	1	SODIMM 1GB DDRII667 HYNIX HYMP112S64CP6-Y5 LF	KN.1GB0G.012
	1	SODIMM 1GB DDRII 800 NANYA NT1GT64UH8D0FN-AD LF 64*16 0.07UM	KN.1GB03.025
	1	SODIMM 1GB DDRII 800 SAMSUNG M470T2864EH3-CF7 LF 64*16 0.055UM	KN.1GB0B.033
	1	SODIMM 2GB DDRII667 HYNIX HYMP125S64CP8-Y5 LF	KN.2GB0G.004
	1	SODIMM 2GB DDRII667 SAMSUNG M470T5663QZ3-CE6 LF	KN.2GB0B.003
	1	SODIMM 2GB DDRII 800 NANYA NT2GT64U8HD0BN-AD LF 128*8 0.07UM	KN.2GB03.010
	1	SODIMM 2GB DDRII 800 ELPIDA EBE21UE8AFSA-8G-F LF 128*8 0.065UM	KN.2GB09.005
	1	SODIMM 2GB DDRII 800 SAMSUNG M470T5663EH3-CF7 LF 128*8 0.055UM	KN.2GB0B.018
<b>MICROPHONE</b>	2	MICROPHONE	23.42231.001
	2	MICROPHONE	23.40544.001
	2	MICROPHONE	23.42238.001
	2	MICROPHONE	23.42239.001
<b>MISCELLANEOUS</b>	2	LCD COVER SPONGE LEFT	47.PAT01.001
	2	LCD COVER SPONGE RIGHT	47.PAT01.002
	1	LCD SCREW RUBBER	47.AU401.001
	1	NAME PLATE AS5542	40.4FN07.001
<b>SCREWS</b>	1	SCREW M2.5X6	86.00E12.536
	1	SCREW M2X4	86.00E13.524
	1	SCREW M2.5*L8 NYLOK CR3+	86.00E34.738
	1	SCREW M2.5X10	86.1Z533.100
	1	SCREW M2X3	86.9A522.3R0
	1	SCREW M2X4 WAFER NI	86.9A552.4R0
	1	SCREW MACH WAFER M3XL4 NI	86.9A554.4R0
<b>SPEAKER</b>	2	SPEAKER ON LOWER CASE	23.PAW01.001
	2	SPEAKER ON UPPER CASE	23.PAW01.002

7. ACER\_ASPIRE 5738Z UMA\_JV50\_MV (NO:91.4CG01.001G)



Category	No.	Part Name and Description	Acer Part No.	
<b>ADAPTER</b> 	1	ADAPTER 65W 19V 3PIN HIPRO HP-A0652R3B 1LF LV5 LED LF YELLOW	AP.06503.024	
	1	ADAPTER 65W 19V 3PIN DELTA ADP-65JH DB A LV5 LED LF YELLOW	AP.0650A.012	
	1	ADAPTER 65W 19V 3PIN LITEON PA-1650-22AC LV5 LED LF YELLOW	AP.06501.026	
<b>BATTERY</b> 	1	BATTERY PANASONIC AS-2007A LI-ION 3S2P PANASONIC 6 CELL 4400MAH MAIN COMMON PSS	BT.00607.034	
	1	BATTERY SANYO AS-2007A LI-ION 3S2P SANYO 6 CELL 4400MAH MAIN COMMON NORMAL TYPE	BT.00605.020	
	1	BATTERY SONY AS-2007A LI-ION 3S2P SONY 6 CELL 4400MAH MAIN COMMON NORMAL TYPE	BT.00603.041	
	1	BATTERY SIMPLO AS-2007A LI-ION 3S2P PANASONIC 6 CELL 4400MAH MAIN COMMON PSS	BT.00604.024	
	1	BATTERY SIMPLO AS-2007A LI-ION 3S2P LGC 6 CELL 2150MAH 2ND COMMON	BT.00607.015	
	1	BATTERY SIMPLO AS-2007A LI-ION 3S2P SAMSUNG 6 CELL 4400MAH MAIN COMMON SDI 2.2MAH F TYPE	BT.00607.019	
<b>BOARDS</b> 	1	BLUETOOTH BOARD FOXCONN BCM2045 V2 T60H928.11	BT.21100.005	
		1	FINGER PRINT BASE BOARD	55.PAX01.001
		1	FINGER PRINT SENSOR BOARD	55.PAX01.002
		2	INVERTER BOARD 17" DARFON VK.21189.408	19.21072.081
		2	INVERTER BOARD YEC YNV-W15	19.21066.041
		1	LED BUTTON BOARD	55.PAT01.001
		1	MINI WLAN/B FOXCONN 802.11BGN Atheros XB63 BG T60H976.00 FW:V06 MINICARD	NI.23600.007
		2	MODEM BOARD FOXCONN DELPHI-AM5 V2H 1.5_3.3V AUS T60M951.36	FX.22500.023
		1	SD DUMMY CARD	42.TKJ01.001
		1	TOUCHPAD BOARD SYNAPTICS TM00540-005	56.17010.181



Category	No.	Part Name and Description	Acer Part No.
	1	TOUCHPAD BOARD ALPS KGDF0038A	56.17024.051
	1	USB BOARD	55.PAT01.002
	1	WIRELESS LAN BOARD 802.11BGN FOXCONN T77H053.00 ATHEROS AR5B91 1X2	NI.23600.030
	1	WIRELESS LAN BOARD 802.11BGN FOXCONN T77H028.00 RALINK RT2700E 1X2	NI.23600.031
	1	WIRELESS LAN BOARD 802.11BGN QMI EM303-AR ATHEROS AR5B91 1X2 MINICARD	NI.23600.033
	1	WIRELESS LAN COVER	42.PAW01.003
<b>CABLES</b>	1	BLUETOOTH BOARD CABLE	50.4CG06.021
	1	BLUETOOTH BOARD CABLE	50.4CG06.001
	1	BLUETOOTH BOARD CABLE	50.4CG06.011
	2	CCFL LCD CABLE W/O CAMERA	50.PAQ01.002
	1	FINGER PRINT / TP BUTTON BAORD CABLE	50.4CG01.011
	1	FINGER PRINT / TP BUTTON BAORD CABLE	50.4CG01.001
	2	LED BUTTON BOARD CABLE	50.4CG02.011
	2	LED BUTTON BOARD CABLE	50.4CG02.001
	2	LED CABLE W/O CAMERA	50.4CG08.001
	2	LED CABLE W/O CAMERA	50.4CG08.011
	2	LED CABLE W/O CAMERA	50.4CG08.021
	2	MODEM CABLE	50.4CG04.001
	2	MODEM CABLE	50.4CG04.011
	1	POWER CORD 2.5A 125V USA	27.01518.A11
	1	POWER CORD 2.5A 125V 1.8M BLACK TAIWANESE	27.01518.781
	1	POWER CORD 10A 250V SWISS	27.01518.691
	1	POWER CORD 10A 250V 3PIN SWISS BK	27.01518.581
	1	POWER CORD 10A 250V ARGENTINE	27.01518.0U1
	1	POWER CORD 10A 125V US	27.01518.641
	1	POWER CORD 10A 125V 3PIN US BK	27.01518.521
	1	POWER CORD 7A 250V 2PIN KOREAN	27.01518.531
	1	POWER CORD 3A 250V 3PIN UK	27.03118.001
	1	POWER CORD 5A 250V 3PIN UK BK	27.01518.541
	1	POWER CORD 7A 125V 2PIN JAPAN	27.01518.551
	1	POWER CORD 10A 3PIN BK DENMARK	27.01518.671
	1	POWER CORD 10A 250V 3PIN DENMARK BK	27.01518.561
1	POWER CORD 10A 250V 3PIN BK SOUTH AFRICA	27.01518.681	



Category	No.	Part Name and Description	Acer Part No.
<b>CABLES</b>	1	POWER CORD 16A 250V SOUTH AFRICA BK	27.01518.571
	1	POWER CORD 10A 250V 3PIN CHINA	27.01518.701
	1	POWER CORD 10A 250V 3PIN CHINA BK	27.01518.591
	1	POWER CORD 250V 3PIN EUR BK	27.01518.731
	1	POWER CABLE 16A 250V 3PIN EUR BK	27.01518.601
	1	POWER CORD 10A 250V 3PIN ITALY	27.01518.711
	1	POWER CORD 10A 250V 3PIN ITALY BK	27.01518.611
	1	POWER CORD 2.5A 250V AUSTRALIA	27.01518.621
	1	POWER CORD 2.5A 250V SOUTH AFRICA BK (INDIA)	27.01518.721
	1	POWER CORD 10A 250V SOUTH AFRICA BK (INDIA)	27.01518.631
	1	POWER CORD 7A 125V 2PIN JAPAN BK	27.01518.661
	1	POWER CORD 250V 10A 3PIN ISRAEL	27.01518.761
	1	POWER CORD 10A 250V 1.8M BRAZIL BLK	27.01518.A41
	1	POWER CORD ACA / ACNZ	27.03218.051
	1	POWER CORD 7.5A 250V 3P AUSTRALIA BK	27.03218.021
	1	POWER CODE 7A 125V 2PIN JAPAN	27.03518.161
	1	TOUCHPAD CABLE	50.4CG03.011
	1	TOUCHPAD CABLE	50.4CG03.001
	1	USB BOARD CABLE	50.4CG05.021
	1	USB BOARD CABLE	50.4CG05.001
1	USB BOARD CABLE	50.4CG05.011	
<b>CASE/COVER/BRACKET ASSEMBLY</b>	2	BLUE-RAY COMBO BEZEL	42.PAW01.005
			
	2	HDD BRACKET	33.PAW01.003
	2	LCD BEZEL 15.6" W/O CAMERA HOLE	60.PAQ01.001
	2	LCD BRACKET W/HINGE RIGHT	34.4K808.001
	2	LCD BRACKET W/HINGE RIGHT	34.4K808.011
	2	LCD BRACKET W/HINGE LEFT	34.4K809.021
	2	LCD BRACKET W/HINGE LEFT	34.4K809.001
	2	LCD BRACKET W/HINGE LEFT	34.4K809.011
	2	LCD COVER IMR 15.6" W/ANTENNA*2 & LOGO NONE 3G	60.PAT01.002
	2	LCD COVER IMR 15.6" W/ANTENNA*3 & LOGO NONE 3G	60.PAQ01.002
	2	LED LCD BRACKET RIGHT W/HINGE	34.4CG12.001
	2	LED LCD BRACKET RIGHT W/HINGE	34.4CG12.011
	2	LED LCD BRACKET RIGHT W/HINGE	34.4CG12.021
	2	LED LCD BRACKET LEFT W/HINGE	34.4CG13.001
	2	LED LCD BRACKET LEFT W/HINGE	34.4CG13.011
	2	LED LCD BRACKET LEFT W/HINGE	34.4CG13.021
	1	MIDDLE COVER W/BLUETOOTH BUTTON WITH BLUE LIGHT NONE 3G	42.PAT01.001

Category	No.	Part Name and Description	Acer Part No.
<b>CASE/COVER/BRACKET ASSEMBLY</b> 	2	OPTICAL BRACKET	33.PAW01.002
	1	LOWER CASE W/MODEM CABLE&SPEAKER	60.PAW01.001
	2	OPTICAL BRACKET	33.PAW01.002
	1	TOUCHPAD BRACKET	33.PAW01.001
	1	UNITLOAD COVER	42.PAW01.002
	1	UPPER CASE W/LED BUTTON BOARD CABLE&MICROPHONE&SPEAKER&FINGER PRINT HOLE	60.PAX01.001
	1	CPU INTEL MEROM PENTIUM DUAL-CORE T3400 2.16G 1M 667 MV	KC.34001.DTP
	1	CPU INTEL PENTIUM DUAL-CORE T4200 PGA 2.0G 1M 800 35W R-0	KC.42001.DTP
<b>HDD/HARD DISK DRIVE</b> 	1	HDD MODULE 160GB 5400RPM SATA	
	2	HDD 160GB 5400RPM SATA WD WD1600BEVT-22ZCT0 FW:11.01A11	KH.16007.019
	2	HDD 160GB 5400RPM SATA SEAGATE ST9160310AS F/W:2010	KH.16008.022
	2	HDD 160GB 5400RPM SATA TOSHIBA LIBRA-BS MK1655GSX F/W:FG0101J 5.4	KH.16001.034
	2	HDD 160GB 5400RPM SATA HGST HTS543216L9A300 F/W:C30C	KH.16004.006
	1	HDD MODULE 250GB 5400RPM SATA	
	2	HDD 250GB 5400RPM SATA SEAGATE ST9250315AS LF F/W:0001SDM1	KH.25008.021
	2	HDD 250GB 5400RPM SATA TOSHIBA LIBRA-BS MK2555GSX F/W:FG000J 5.4K	KH.25001.016
	2	HDD 250GB 5400RPM SATA HGST HTS545025B9A300 PANTHER-B LF F/W:C50K	KH.25004.003
	2	HDD 250GB 5400RPM SATA WD WD2500BEVT-22ZCT0 F/W:11.01A11	KH.25007.015
	1	HDD MODULE 320GB 5400RPM SATA	
	2	HDD 320GB 5400RPM SATA SEAGATE ST9320320AS F/W:2010	KH.32008.013
	2	HDD 320GB 5400RPM SATA TOSHIBA MK3255GSX LIBRA LF F/W:FG010J	KH.32001.008
	2	HDD 320GB 5400RPM SATA HGST HTS545032B9A300 PANTHER B LF	KH.32004.002

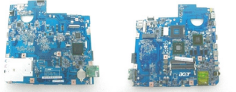
Category	No.	Part Name and Description	Acer Part No.
<b>HDD/HARD DISK DRIVE</b>	2	HDD 320GB 5400RPM SATA WD WD3200BEVT-22ZCT0 ML125 F/ W:01.01A01	KH.32007.007
	1	HDD MODULE 500GB 5400RPM SATA	
	2	HDD SEAGATE 2.5" 5400RPM 500GB ST9500325AS SATA LF F/ W:0001SDM1	KH.50008.013
	2	HDD 500GB 5400RPM SATA TOSHIBA MK5055GSX LIBRA-BS F/ W:FG000J LF	KH.50001.011
	2	HDD 500GB 5400RPM HGST SATA HTS545050B9A300 PANTHER B LF	KH.50004.001
	2	HDD WD 2.5" 500GB 5400RPM SATA WD5000BEVT-22ZAT0 F/ W:01.01A01	KH.50007.009
<b>HEATSINK</b> 	1	CPU HEATSINK W/FAN	60.4CG31.001
	1	CPU HEATSINK W/FAN	60.4CG24.001
	1	CPU HEATSINK W/FAN	60.4CG19.001
<b>KEYBOARD</b> 	1	KEYBOARD 107KEYS NSK-ALA0J AC7T JV50 INTERNAL 17 STANDARD BLACK TEXTURE JAPANESE	KB.I170A.044
	1	KEYBOARD 103KEYS NSK-ALA0J AC7T JV50 INTERNAL 17 STANDARD BLACK TEXTURE GREEK	KB.I170A.041
	1	KEYBOARD 103KEYS NSK-ALA0J AC7T JV50 INTERNAL 17 STANDARD BLACK TEXTURE TAIWAN	KB.I170A.036
	1	KEYBOARD 103KEYS NSK-ALA0J AC7T JV50 INTERNAL 17 STANDARD BLACK TEXTURE THAILAND	KB.I170A.053
	1	KEYBOARD 103KEYS NSK-ALA0J AC7T JV50 INTERNAL 17 STANDARD BLACK TEXTURE HEBREW	KB.I170A.057
	1	KEYBOARD 103KEYS NSK-ALA0J AC7T JV50 INTERNAL 17 STANDARD BLACK TEXTURE ARABIC	KB.I170A.032
	1	KEYBOARD 103KEYS NSK-ALA0J AC7T JV50 INTERNAL 17 STANDARD BLACK TEXTURE US-INTERNATIONAL	KB.I170A.056
	1	KEYBOARD 103KEYS NSK-ALA0J AC7T JV50 INTERNAL 17 STANDARD BLACK TEXTURE RUSSIAN	KB.I170A.048
	1	KEYBOARD 103KEYS NSK-ALA0J AC7T JV50 INTERNAL 17 STANDARD BLACK TEXTURE KOREA	TBD
	1	KEYBOARD 103KEYS NSK-ALA0J AC7T JV50 INTERNAL 17 STANDARD BLACK TEXTURE BLANK	TBD
	1	KEYBOARD 104KEYS NSK-ALA0J AC7T JV50 INTERNAL 17 STANDARD BLACK TEXTURE UK	KB.I170A.055
	1	KEYBOARD 104KEYS NSK-ALA0J AC7T JV50 INTERNAL 17 STANDARD BLACK TEXTURE SWEDISH	KB.I170A.051
	1	KEYBOARD 104KEYS NSK-ALA0J AC7T JV50 INTERNAL 17 STANDARD BLACK TEXTURE FRENCH	KB.I170A.039
	1	KEYBOARD 104KEYS NSK-ALA0J AC7T JV50 INTERNAL 17 STANDARD BLACK TEXTURE PORTUGAL	KB.I170A.047
	1	KEYBOARD 104KEYS NSK-ALA0J AC7T JV50 INTERNAL 17 STANDARD BLACK TEXTURE SLOVE	KB.I170A.049
	1	KEYBOARD 104KEYS NSK-ALA0J AC7T JV50 INTERNAL 17 STANDARD BLACK TEXTURE BRAZILIAN PORTUGUESE	KB.I170A.034
	1	KEYBOARD 104KEYS NSK-ALA0J AC7T JV50 INTERNAL 17 STANDARD BLACK TEXTURE SWISS	KB.I170A.052
	1	KEYBOARD 104KEYS NSK-ALA0J AC7T JV50 INTERNAL 17 STANDARD BLACK TEXTURE DANISH	KB.I170A.037
	1	KEYBOARD 104KEYS NSK-ALA0J AC7T JV50 INTERNAL 17 STANDARD BLACK TEXTURE ITALIAN	KB.I170A.043
	1	KEYBOARD 104KEYS NSK-ALA0J AC7T JV50 INTERNAL 17 STANDARD BLACK TEXTURE BELGIAN	KB.I170A.033
1	KEYBOARD 104KEYS NSK-ALA0J AC7T JV50 INTERNAL 17 STANDARD BLACK TEXTURE GERMAN	KB.I170A.040	

Category	No.	Part Name and Description	Acer Part No.
<b>KEYBOARD</b>	1	KEYBOARD 104KEYS NSK-ALA0J AC7T JV50 INTERNAL 17 STANDARD BLACK TEXTURE CZECH	TBD
	1	KEYBOARD 104KEYS NSK-ALA0J AC7T JV50 INTERNAL 17 STANDARD BLACK TEXTURE FRENCH CANADIAN	TBD
	1	KEYBOARD 104KEYS NSK-ALA0J AC7T JV50 INTERNAL 17 STANDARD BLACK TEXTURE NORWEGIAN	KB.I170A.046
	1	KEYBOARD 104KEYS NSK-ALA0J AC7T JV50 INTERNAL 17 STANDARD BLACK TEXTURE HUNGARIAN	KB.I170A.042
	1	KEYBOARD 104KEYS NSK-ALA0J AC7T JV50 INTERNAL 17 STANDARD BLACK TEXTURE SPANISH	KB.I170A.050
	1	KEYBOARD 104KEYS NSK-ALA0J AC7T JV50 INTERNAL 17 STANDARD BLACK TEXTURE TURKISH	KB.I170A.054
	1	KEYBOARD 104KEYS NSK-ALA0J AC7T JV50 INTERNAL 17 STANDARD BLACK TEXTURE NORDIC	KB.I170A.045
	1	KEYBOARD 104KEYS NSK-ALA0J AC7T JV50 INTERNAL 17 STANDARD BLACK TEXTURE FRENCH ARABIC	KB.I170A.038
	1	KEYBOARD 104KEYS NSK-ALA0J AC7T JV50 INTERNAL 17 STANDARD BLACK TEXTURE FRENCH CANADIAN	KB.I170A.058
	1	KEYBOARD 104KEYS NSK-ALA0J AC7T JV50 INTERNAL 17 STANDARD BLACK TEXTURE CZECH/SLOVAK	KB.I170A.035
	1	KEYBOARD 104KEYS NSK-ALA0J AC7T JV50 INTERNAL 17 STANDARD BLACK TEXTURE SLOVAK	TBD
	1	KEYBOARD 104KEYS NSK-ALA0J AC7T JV50 INTERNAL 17 STANDARD BLACK TEXTURE BLANK	TBD
<b>LCD</b> 	2	LCD AUO 15.6" WXGA GLARE AUO B156XW01 V0 LF 220NIT 8MS	LK.1560D.001
	2	LCD AUO 15.6" WXGA GLARE LG LP156WH1-TLA1 LF 220NIT 8MS 400:1	LK.15605.001
	2	LCD AUO 15.6" WXGA GLARE CMO N156B3-L02 LF 220NIT 8MS	LK.15608.001
	1	CCFL LCD MODULE 15.6" WXGA GLARE W/ANTENNA*3 W/O CAMERA (NONE 3G)	6M.PAQ01.004
	1	CCFL LCD MODULE 15.6" WXGA GLARE W/ANTENNA*2 W/O CAMERA (NONE 3G)	6M.PAQ01.003
	1	LED LCD MODULE 15.6" WXGA GLARE W/ANTENNA*2 W/O CAMERA (NONE 3G)	6M.PAQ01.001
	2	LED LCD 15.6" WXGA GLARE CMO N156B6-L04 LF 220NIT 8MS 500:1	LK.15608.002
	2	LED LCD 15.6" WXGA GLARE SAMSUNG LTN156AT02-A01 LF 220NIT 8MS 500:1	LK.1560D.005
	2	LED LCD 15.6" WXGA GLARE AUO B156XW02 V0 LF 220NIT 8MS 500:1	LK.15606.003
	2	LED LCD 15.6" WXGA GLARE LG LP156WH2-TLE1 LF 220NIT 8MS 400:1	LK.15605.003
	1	LED LCD MODULE 15.6" WXGA GLARE W/ANTENNA*3 W/O CAMERA (NONE 3G)	6M.PAQ01.002
	<b>MAINBOARD</b> 	1	MAINBOARD JV50_MV UMA GL40 ICH9M LF W/RTC BATTERY&MODEM BOARD NONE 3G
<b>MEMORY</b> 	1	SODIMM 1GB DDRIII 1066MHZ MICRON MT8JSF12864HY-1G1D1	KN.1GB0G.019
	1	SODIMM 1GB DDRLLL 1066MHZ ELPIDA EBJ11UE6BBS0-AE-F	KN.1GB04.003
	1	SODIMM 1GB DDRIII 1066MHZ SAMSUNG M471B2874DZ1-CF8	KN.1GB09.011
	1	SODIMM 1GB DDRLLL 1066MHZ SAMSUNG M471B2873EH1-CF8	KN.1GB0B.019
	1	SODIMM 1GB DDRLLL 1066MHZ HYNIX HMT112S6AFP6C-G7N0	KN.1GB0B.028
	1	SODIMM 2GB DDRIII 1066MHZ MICRON MT16JSF25664HY-1G1D1	KN.2GB0G.009
	1	SODIMM 2GB DDRLLL 1066MHZ ELPIDA EBJ21UE8BBS0-AE-F	KN.2GB04.004

Category	No.	Part Name and Description	Acer Part No.
MEMORY	1	SODIMM 2GB DDRIII 1066MHZ SAMSUNG M471B5673DZ1-CF8	KN.2GB09.004
	1	SODIMM 2GB DDRLLL 1066MHZ SAMSUNG M471B5673EH1-CF8	KN.2GB0B.005
	1	SODIMM 2GB DDRLLL 1066MHZ HYNIX HMT125S6AFP8C-G7N0	KN.2GB0B.012
MICROPHONE	2	MICROPHONE	23.42239.001
	2	MICROPHONE	23.42231.001
	2	MICROPHONE	23.40544.001
	2	MICROPHONE	23.42238.001
MISCELLANEOUS	1	LCD SCREW RUBBER	47.AU401.001
			
	1	LCD COVER SPONGE LEFT	47.PAT01.001
	1	LCD COVER SPONGE RIGHT	47.PAT01.002
	1	NAME PLATE AS5738Z	40.PAT01.001
ODD MODULE	1	BLU-RAY COMBO MODULE 4X SATA	6M.PAW01.001
	2	ODD PLDS BD COMBO 12.7MM TRAY DL 4X DS-4E1S LF W/O BEZEL SATA	KO.0040D.002
	2	ODD PIONEER BD COMBO 12.7 SATA DL 4X BDC-TD01RS LF W/O BEZEL SATA	KO.0040F.001
	2	ODD HLDS BD COMBO 12.7MM TRAY DL 4X CT10 LF W/O BEZEL SATA	KO.00405.002
	1	DVD-RW SUPER-MULTI MODULE 8X SATA	6M.PAW01.002
	2	DVD-RW SUPER-MULTI BEZEL	42.PAW01.004
	2	ODD SONY SUPER-MULTI DRIVE 12.7MM TRAY DL 8X AD-7590S LF W/O BEZEL SATA	KU.0080F.004
	2	ODD TOSHIBA SUPER-MULTI DRIVE 12.7MM TRAY DL 8X SATA TS-L633B LF W/O BEZEL	KU.0080E.025
	2	ODD HLDS SUPER-MULTI DRIVE 12.7MM TRAY DL 8X GT20N LF W/O BEZEL SATA	KU.00801.030
	2	ODD SONY SUPER-MULTI DRIVE 12.7MM TRAY DL 8X AD-7580S LF W/O BEZEL SATA	KU.0080D.040
	2	ODD PLDS SUPER-MULTI DRIVE 12.7MM TRAY DL 8X SATA DS-8A3S LF W/O BEZEL	KU.0080E.017
SPEAKER	2	SPEAKER ON UPPER CASE	23.40543.001
	2	SPEAKER ON UPPER CASE	23.40535.001
	2	SPEAKER ON UPPER CASE	23.40542.001
	2	SPEAKER ON LOWER CASE	23.40536.001
	2	SPEAKER ON LOWER CASE	23.40539.001
SCREWS	1	ISO M2.5XL6(H=0.7~0.8MM)	86.00E12.536
	1	SCREW M2.5XL8 NYLOK CR3+	86.00E34.738
	1	SCREW M2.5XL10	86.1Z533.100
	1	SCREW M2XL3	86.9A522.3R0
	1	SCREW M2XL4 WAFER NI	86.9A552.4R0
	1	SCREW MACH WAFER M3XL4 NI	86.9A554.4R0

8. ACER AS5738ZG\_N10



Category	No.	Part Name and Description	Acer Part No.
<b>ADAPTER</b> 	1	ADAPTER 65W 19V 3PIN HIPRO HP-A0652R3B 1LF LV5 LED LF YELLOW	AP.06503.024
	1	ADAPTER 65W 19V 3PIN DELTA ADP-65JH DB A LV5 LED LF YELLOW	AP.0650A.012
	1	ADAPTER 65W 19V 3PIN LITEON PA-1650-22AC LV5 LED LF YELLOW	AP.06501.026
<b>BATTERY</b> 	1	BATTERY PANASONIC AS-2007A LI-ION 3S2P PANASONIC 6 CELL 4400MAH MAIN COMMON PSS	BT.00607.034
	1	BATTERY SONY AS-2007A LI-ION 3S2P SONY 6 CELL 4400MAH MAIN COMMON NORMAL TYPE	BT.00605.020
	1	BATTERY SANYO AS-2007A LI-ION 3S2P SANYO 6 CELL 4400MAH MAIN COMMON NORMAL TYPE	BT.00604.024
	1	BATTERY SIMPLO AS-2007A LI-ION 3S2P PANASONIC 6 CELL 4400MAH MAIN COMMON PSS	BT.00603.041
	1	BATTERY SIMPLO AS-2007A LI-ION 3S2P LGC 6 CELL 2150MAH 2ND COMMON	BT.00607.015
	1	BATTERY SIMPLO AS-2007A LI-ION 3S2P SAMSUNG 6 CELL 4400MAH MAIN COMMON SDI 2.2MAH F TYPE	BT.00607.019
<b>BOARDS</b> 	1	BLUETOOTH BOARD FOXCONN BCM2045 V2 T60H928.11	BT.21100.005
	2	INVERTER BOARD YEC YNV-W15	19.21066.041
	2	INVERTER BOARD 17" DARFON VK.21189.408	19.21072.081
	1	LED BUTTON BOARD	55.PAT01.001
	1	MINI WLAN/B FOXCONN 802.11BGN Atheros XB63 BG T60H976.00 FW:V06 MINICARD	NI.23600.007
	2	MODEM BOARD FOXCONN DELPHI-AM5 V2H 1.5_3.3V AUS T60M951.36	FX.22500.023
	1	TOUCHPAD BOARD SYNAPTICS TM00540-005	56.17010.181
	1	TOUCHPAD BOARD ALPS KGDF0038A	56.17024.051
<b>BOARDS</b> 	1	TOUCH PAD BUTTON BOARD	55.PAW01.003
	1	USB BOARD	55.PAT01.002
	1		



Category	No.	Part Name and Description	Acer Part No.
<b>BOARDS</b> 	1	WIRELESS LAN BOARD 802.11BGN FOXCONN T77H028.00 RALINK RT2700E 1X2	NI.23600.031
	1	WIRELESS LAN BOARD 802.11BGN FOXCONN T77H053.00 Atheros AR5B91 1X2	NI.23600.030
	1	WIRELESS LAN BOARD 802.11BGN QMI EM303-AR Atheros AR5B91 1X2 MINICARD	NI.23600.033
<b>CABLES</b>	1	BLUETOOTH BOARD CABLE	50.4CG06.021
	1	BLUETOOTH BOARD CABLE	50.4CG06.001
	1	BLUETOOTH BOARD CABLE	50.4CG06.011
	1	FINGER PRINT / TP BUTTON BAORD CABLE	50.4CG01.011
	1	FINGER PRINT / TP BUTTON BAORD CABLE	50.4CG01.001
	2	CCFL LCD/CAMERA CABLE	50.4CG13.021
	2	CCFL LCD/CAMERA CABLE	50.4CG13.001
	2	CCFL LCD/CAMERA CABLE	50.4CG13.011
	2	LED BUTTON BOARD CABLE	50.4CG02.011
	2	LED BUTTON BOARD CABLE	50.4CG02.001
	2	LED LCD/CAMERA CABLE	50.4CG14.001
	2	LED LCD/CAMERA CABLE	50.4CG14.021
	2	LED LCD/CAMERA CABLE	50.4CG14.031
	2	MODEM CABLE	50.4CG04.001
	2	MODEM CABLE	50.4CG04.011
	1	POWER CORD 3A 250V 3PIN UK	27.03118.001
	1	POWER CORD 5A 250V 3PIN UK BK	27.01518.541
	1	POWER CORD 2.5A 125V USA	27.01518.A11
	1	POWER CORD 2.5A 125V 1.8M BLACK TAIWANESE	27.01518.781
	1	POWER CORD 10A 250V SWISS	27.01518.691
	1	POWER CORD 10A 250V 3PIN SWISS BK	27.01518.581
	1	POWER CORD 10A 250V ARGENTINE	27.01518.0U1
	1	POWER CORD 10A 125V US	27.01518.641
	1	POWER CORD 10A 125V 3PIN US BK	27.01518.521
	1	POWER CORD 7A 250V 2PIN KOREAN	27.01518.531
	1	POWER CORD 7A 125V 2PIN JAPAN	27.01518.551
	1	POWER CORD 10A 3PIN BK DENMARK	27.01518.671
	1	POWER CORD 10A 250V 3PIN DENMARK BK	27.01518.561
	1	POWER CORD 10A 250V 3PIN BK SOUTH AFRICA	27.01518.681
	1	POWER CORD 16A 250V SOUTH AFRICA BK	27.01518.571
	1	POWER CORD 10A 250V 3PIN CHINA	27.01518.701
	1	POWER CORD 10A 250V 3PIN CHINA BK	27.01518.591
	1	POWER CORD 250V 3PIN EUR BK	27.01518.731
	1	POWER CABLE 16A 250V 3PIN EUR BK	27.01518.601
	1	POWER CORD 10A 250V 3PIN ITALY	27.01518.711
	1	POWER CORD 10A 250V 3PIN ITALY BK	27.01518.611
	1	POWER CORD 2.5A 250V AUSTRALIA	27.01518.621
	1	POWER CORD 2.5A 250V SOUTH AFRICA BK (INDIA)	27.01518.721
	1	POWER CORD 10A 250V SOUTH AFRICA BK (INDIA)	27.01518.631
	1	POWER CORD 7A 125V 2PIN JAPAN BK	27.01518.661
	1	POWER CORD 250V 10A 3PIN ISRAEL	27.01518.761
	1	POWER CORD 10A 250V 1.8M BRAZIL BLK	27.01518.A41
1	POWER CORD ACA / ACNZ	27.03218.051	
1	POWER CORD 7.5A 250V 3P AUSTRALIA BK	27.03218.021	

Category	No.	Part Name and Description	Acer Part No.
<b>CABLES</b>	1	POWER CODE 7A 125V 2PIN JAPAN	27.03518.161
	1	TOUCHPAD CABLE	50.4CG03.011
	1	TOUCHPAD CABLE	50.4CG03.001
	1	USB BOARD CABLE	50.4CG05.021
	1	USB BOARD CABLE	50.4CG05.001
	1	USB BOARD CABLE	50.4CG05.011
<b>CAMERA</b> 	2	CAMERA 0.3M CHICONY CNF701721004973L	56.18012.094
		2	CAMERA 0.3M SUYIN CN0314-SN30-OV03-5
<b>CASE/COVER/BRAKET ASSEMBLY</b> 	2	BLUE-RAY COMBO BEZEL	42.PAW01.005
	2	DVD-RW SUPER-MULTI BEZEL	42.PAW01.004
	2	HDD BRACKET	33.PAW01.003
	2	LCD BEZEL 15.6" W/CAMERA HOLE	60.PAW01.004
	2	LCD BRACKET W/HINGE RIGHT	34.4K808.001
	2	LCD BRACKET W/HINGE RIGHT	34.4K808.011
	2	LCD BRACKET W/HINGE RIGHT	34.4K808.021
	2	LCD BRACKET W/HINGE LEFT	34.4K809.001
	2	LCD BRACKET W/HINGE LEFT	34.4K809.011
	2	LCD BRACKET W/HINGE LEFT	34.4K809.021
	2	LCD COVER IMR 15.6" W/ANTENNA*3 & LOGO NONE 3G	60.PAQ01.002
	2	LCD COVER IMR 15.6" W/ANTENNA*2 & LOGO NONE 3G	60.PAT01.002
	2	LED LCD BRACKET RIGHT W/HINGE	34.4CG12.001
	2	LED LCD BRACKET RIGHT W/HINGE	34.4CG12.011
	2	LED LCD BRACKET RIGHT W/HINGE	34.4CG12.021
	2	LED LCD BRACKET LEFT W/HINGE	34.4CG13.001
	2	LED LCD BRACKET LEFT W/HINGE	34.4CG13.011
	2	LED LCD BRACKET LEFT W/HINGE	34.4CG13.021
	1	LOWER CASE W/MODEM CABLE&SPEAKER	60.PAW01.001
	1	MIDDLE COVER W/BLUETOOTH BUTTON WITH BLUE LIGHT NONE 3G	42.PAT01.001



Category	No.	Part Name and Description	Acer Part No.
<b>CASE/COVER/BRACKET ASSEMBLY</b> 	2	OPTICAL BRACKET	33.PAW01.002
	1	SD DUMMY CARD	42.TKJ01.001
	1	TOUCHPAD BRACKET	33.PAW01.001
	1	UPPER CASE W/LED BUTTON BOARD CABLE&MICROPHONE&SPEAKER W/O FINGER PRINT HOLE	60.PAW01.002
	1	UNITLOAD COVER	42.PAW01.002
	1	WIRELESS LAN COVER	42.PAW01.003
<b>CPU/PROCESSOR</b> 	1	CPU INTEL PENTIUM DUAL-CORE T4200 PGA 2.0G 1M 800 35W R-0	KC.42001.DTP
	1	CPU INTEL MEROM PENTIUM DUAL-CORE T3400 2.16G 1M 667 MV	KC.34001.DTP
<b>HDD/HARD DISK DRIVE</b> 	1	HDD MODULE 160GB 5400RPM SATA	
	2	HDD 160GB 5400RPM SATA WD WD1600BEVT-22ZCT0 F/W:11.01A11	KH.16007.019
	2	HDD 160GB 5400RPM SATA SEAGATE ST9160310AS F/W:2010	KH.16008.022
	2	HDD 160GB 5400RPM SATA TOSHIBA LIBRA-BS MK1655GSX F/W:FG0101J 5.4	KH.16001.034
	2	HDD 160GB 5400RPM SATA HGST HTS543216L9A300 F/W:C30C	KH.16004.006
	1	HDD MODULE 250GB 5400RPM SATA	
	2	HDD 250GB 5400RPM SATA WD WD2500BEVT-22ZCT0 F/W:11.01A11	KH.25004.003
	2	HDD 250GB 5400RPM SATA HGST HTS545025B9A300 PANTHER-B LF F/W:C50K	KH.25008.021
	2	HDD 250GB 5400RPM SATA SEAGATE ST9250315AS LF F/W:0001SDM1	KH.25007.015
	2	HDD 250GB 5400RPM SATA TOSHIBA LIBRA-BS MK2555GSX F/W:FG000J 5.4K	KH.25001.016
	1	HDD MODULE 320GB 5400RPM SATA	
	2	HDD 320GB 5400RPM SATA HGST HTS545032B9A300 PANTHER B LF	KH.32008.013
	2	HDD 320GB 5400RPM SATA SEAGATE ST9320320AS F/W:2010	KH.32007.007
	2	HDD 320GB 5400RPM SATA TOSHIBA MK3255GSX LIBRA LF F/W:FG010J	KH.32001.008
	2	HDD 320GB 5400RPM SATA WD WD3200BEVT-22ZCT0 ML125 F/W:01.01A01	KH.32004.002
1	HDD MODULE 500GB 5400RPM SATA		

Category	No.	Part Name and Description	Acer Part No.
<b>HDD/HARD DISK DRIVE</b>	2	HDD SEAGATE 2.5" 5400RPM 500GB ST9500325AS SATA LF F/ W:0001SDM1	KH.50008.013
	2	HDD 500GB 5400RPM SATA TOSHIBA MK5055GSX LIBRA-BS F/ W:FG000J LF	KH.50001.011
	2	HDD 500GB 5400RPM HGST SATA HTS545050B9A300 PANTHER B LF	KH.50004.001
	2	HDD WD 2.5" 500GB 5400RPM SATA WD5000BEVT-22ZAT0 F/ W:01.01A01	KH.50007.009
<b>HEATSINK</b> 	1	CPU HEATSINK W/FAN	60.4CG22.001
	1	CPU HEATSINK W/FAN	60.4CG27.001
	1	CPU HEATSINK W/FAN	60.4CG15.001
<b>KEYBOARD</b> 	1	KEYBOARD 104KEYS NSK-ALA0J AC7T JV50 INTERNAL 17 STANDARD BLACK TEXTURE UK	KB.I170A.055
	1	KEYBOARD 103KEYS NSK-ALA0J AC7T JV50 INTERNAL 17 STANDARD BLACK TEXTURE US-INTERNATIONAL	KB.I170A.056
	1	KEYBOARD 107KEYS NSK-ALA0J AC7T JV50 INTERNAL 17 STANDARD BLACK TEXTURE JAPANESE	KB.I170A.044
	1	KEYBOARD 103KEYS NSK-ALA0J AC7T JV50 INTERNAL 17 STANDARD BLACK TEXTURE GREEK	KB.I170A.041
	1	KEYBOARD 103KEYS NSK-ALA0J AC7T JV50 INTERNAL 17 STANDARD BLACK TEXTURE TAIWAN	KB.I170A.036
	1	KEYBOARD 103KEYS NSK-ALA0J AC7T JV50 INTERNAL 17 STANDARD BLACK TEXTURE THAILAND	KB.I170A.053
	1	KEYBOARD 103KEYS NSK-ALA0J AC7T JV50 INTERNAL 17 STANDARD BLACK TEXTURE HEBREW	KB.I170A.057
	1	KEYBOARD 103KEYS NSK-ALA0J AC7T JV50 INTERNAL 17 STANDARD BLACK TEXTURE ARABIC	KB.I170A.032
	1	KEYBOARD 103KEYS NSK-ALA0J AC7T JV50 INTERNAL 17 STANDARD BLACK TEXTURE RUSSIAN	KB.I170A.048
	1	KEYBOARD 103KEYS NSK-ALA0J AC7T JV50 INTERNAL 17 STANDARD BLACK TEXTURE KOREA	TBD
	1	KEYBOARD 103KEYS NSK-ALA0J AC7T JV50 INTERNAL 17 STANDARD BLACK TEXTURE BLANK	TBD
	1	KEYBOARD 104KEYS NSK-ALA0J AC7T JV50 INTERNAL 17 STANDARD BLACK TEXTURE SWEDISH	KB.I170A.051
	1	KEYBOARD 104KEYS NSK-ALA0J AC7T JV50 INTERNAL 17 STANDARD BLACK TEXTURE FRENCH	KB.I170A.039
	1	KEYBOARD 104KEYS NSK-ALA0J AC7T JV50 INTERNAL 17 STANDARD BLACK TEXTURE PORTUGAL	KB.I170A.047
	1	KEYBOARD 104KEYS NSK-ALA0J AC7T JV50 INTERNAL 17 STANDARD BLACK TEXTURE SLOVE	KB.I170A.049
	1	KEYBOARD 104KEYS NSK-ALA0J AC7T JV50 INTERNAL 17 STANDARD BLACK TEXTURE BRAZILIAN PORTUGUESE	KB.I170A.034
	1	KEYBOARD 104KEYS NSK-ALA0J AC7T JV50 INTERNAL 17 STANDARD BLACK TEXTURE SWISS	KB.I170A.052
	1	KEYBOARD 104KEYS NSK-ALA0J AC7T JV50 INTERNAL 17 STANDARD BLACK TEXTURE DANISH	KB.I170A.037
	1	KEYBOARD 104KEYS NSK-ALA0J AC7T JV50 INTERNAL 17 STANDARD BLACK TEXTURE ITALIAN	KB.I170A.043
	1	KEYBOARD 104KEYS NSK-ALA0J AC7T JV50 INTERNAL 17 STANDARD BLACK TEXTURE BELGIAN	KB.I170A.033
	1	KEYBOARD 104KEYS NSK-ALA0J AC7T JV50 INTERNAL 17 STANDARD BLACK TEXTURE GERMAN	KB.I170A.040
1	KEYBOARD 104KEYS NSK-ALA0J AC7T JV50 INTERNAL 17 STANDARD BLACK TEXTURE CZECH	TBD	
1	KEYBOARD 104KEYS NSK-ALA0J AC7T JV50 INTERNAL 17 STANDARD BLACK TEXTURE FRENCH CANADIAN	TBD	

Category	No.	Part Name and Description	Acer Part No.
<b>KEYBOARD</b>	1	KEYBOARD 104KEYS NSK-ALA0J AC7T JV50 INTERNAL 17 STANDARD BLACK TEXTURE NORWEGIAN	KB.I170A.046
	1	KEYBOARD 104KEYS NSK-ALA0J AC7T JV50 INTERNAL 17 STANDARD BLACK TEXTURE HUNGARIAN	KB.I170A.042
	1	KEYBOARD 104KEYS NSK-ALA0J AC7T JV50 INTERNAL 17 STANDARD BLACK TEXTURE SPANISH	KB.I170A.050
	1	KEYBOARD 104KEYS NSK-ALA0J AC7T JV50 INTERNAL 17 STANDARD BLACK TEXTURE TURKISH	KB.I170A.054
	1	KEYBOARD 104KEYS NSK-ALA0J AC7T JV50 INTERNAL 17 STANDARD BLACK TEXTURE NORDIC	KB.I170A.045
	1	KEYBOARD 104KEYS NSK-ALA0J AC7T JV50 INTERNAL 17 STANDARD BLACK TEXTURE FRENCH ARABIC	KB.I170A.038
	1	KEYBOARD 104KEYS NSK-ALA0J AC7T JV50 INTERNAL 17 STANDARD BLACK TEXTURE FRENCH CANADIAN	KB.I170A.058
	1	KEYBOARD 104KEYS NSK-ALA0J AC7T JV50 INTERNAL 17 STANDARD BLACK TEXTURE CZECH/SLOVAK	KB.I170A.035
	1	KEYBOARD 104KEYS NSK-ALA0J AC7T JV50 INTERNAL 17 STANDARD BLACK TEXTURE SLOVAK	TBD
	1	KEYBOARD 104KEYS NSK-ALA0J AC7T JV50 INTERNAL 17 STANDARD BLACK TEXTURE BLANK	TBD
<b>LCD</b> 	1	LED LCD MODULE 15.6" WXGA GLARE W/ ANTENNA*2&CAMERA (NONE 3G)	6M.PAT01.001
	2	LED LCD 15.6" WXGA GLARE CMO N156B6-L04 LF 220NIT 8MS 500:1	LK.15608.002
	2	LED LCD 15.6" WXGA GLARE SAMSUNG LTN156AT02-A01 LF 220NIT 8MS 500:1	LK.1560D.005
	2	LED LCD 15.6" WXGA GLARE AUO B156XW02 V0 LF 220NIT 8MS 500:1	LK.15606.003
	2	LED LCD 15.6" WXGA GLARE LG LP156WH2-TLE1 LF 220NIT 8MS 400:1	LK.15605.003
	1	CCFL LCD MODULE 15.6" WXGA GLARE W/ ANTENNA*2&CAMERA (NONE 3G)	6M.PAT01.002
	1	LED LCD MODULE 15.6" WXGA GLARE W/ ANTENNA*3&CAMERA (NONE 3G)	6M.PAN01.001
	2	LCD AUO 15.6" WXGA GLARE AUO B156XW01 V0 LF 220NIT 8MS	LK.1560D.001
	2	LCD AUO 15.6" WXGA GLARE LG LP156WH1-TLA1 LF 220NIT 8MS 400:1	LK.15605.001
	2	LCD AUO 15.6" WXGA GLARE CMO N156B3-L02 LF 220NIT 8MS	LK.15608.001
	1	CCFL LCD MODULE 15.6" WXGA GLARE W/ ANTENNA*3&CAMERA (NONE 3G)	6M.PAN01.002
	<b>MAINBOARD</b> 	1	MAINBOARD JV50_MV DIS GM45 ICH9M NVIDIA N10MGE1 VRAM SAMSUNG DDRII500 1GB LF W/RTC BATTERY&MODEM BOARD NONE 3G
<b>MEMORY</b> 	1	SODIMM 1GB DDRLLL 1066MHZ HYNIX HMT112S6AFP6C-G7N0	KN.1GB0B.028
	1	SODIMM 1GB DDRIII 1066MHZ SAMSUNG M471B2874DZ1-CF8	KN.1GB0G.019
	1	SODIMM 1GB DDRIII 1066MHZ MICRON MT8JSF12864HY-1G1D1	KN.1GB0B.019
	1	SODIMM 1GB DDRLLL 1066MHZ ELPIDA EBJ11UE6BBS0-AE-F	KN.1GB04.003
	1	SODIMM 1GB DDRLLL 1066MHZ SAMSUNG M471B2873EH1-CF8	KN.1GB09.011
	1	SODIMM 2GB DDRLLL 1066MHZ HYNIX HMT125S6AFP8C-G7N0	KN.2GB0B.012
	1	SODIMM 2GB DDRIII 1066MHZ SAMSUNG M471B5673DZ1-CF8	KN.2GB0G.009
	1	SODIMM 2GB DDRIII 1066MHZ MICRON MT16JSF25664HY-1G1D1	KN.2GB0B.005
	1	SODIMM 2GB DDRLLL 1066MHZ ELPIDA EBJ21UE8BBS0-AE-F	KN.2GB04.004
	1	SODIMM 2GB DDRLLL 1066MHZ SAMSUNG M471B5673EH1-CF8	KN.2GB09.004

Category	No.	Part Name and Description	Acer Part No.
<b>MICROPHONE</b>	2	MICROPHONE	23.42239.001
	2	MICROPHONE	23.42231.001
	2	MICROPHONE	23.40544.001
	2	MICROPHONE	23.42238.001
<b>MISCELLANEOUS</b>	1	LCD SCREW RUBBER	47.AU401.001
	1	NAME PLATE AS5738Z	40.PAT01.001
	1	LCD COVER SPONGE LEFT	47.PAT01.001
	1	LCD COVER SPONGE RIGHT	47.PAT01.002
<b>ODD MODULE</b> 	1	BLU-RAY COMBO MODULE 4X SATA	6M.PAW01.001
	2	ODD PLDS BD COMBO 12.7MM TRAY DL 4X DS-4E1S LF W/O BEZEL SATA	KO.0040D.002
	2	ODD PIONEER BD COMBO 12.7 SATA DL 4X BDC-TD01RS LF W/O BEZEL SATA	KO.0040F.001
	2	ODD HLDS BD COMBO 12.7MM TRAY DL 4X CT10 LF W/O BEZEL SATA	KO.00405.002
	1	DVD-RW SUPER-MULTI MODULE 8X SATA	6M.PAW01.002
	2	ODD SONY SUPER-MULTI DRIVE 12.7MM TRAY DL 8X AD-7580S LF W/O BEZEL SATA	KU.0080D.040
	2	ODD TOSHIBA SUPER-MULTI DRIVE 12.7MM TRAY DL 8X SATA TS-L633B LF W/O BEZEL	KU.0080F.004
	2	ODD SONY SUPER-MULTI DRIVE 12.7MM TRAY DL 8X AD-7590S LF W/O BEZEL SATA	KU.00801.030
	2	ODD HLDS SUPER-MULTI DRIVE 12.7MM TRAY DL 8X GT20N LF W/O BEZEL SATA	KU.0080E.025
	2	ODD PLDS SUPER-MULTI DRIVE 12.7MM TRAY DL 8X SATA DS-8A3S LF W/O BEZEL	KU.0080D.040
<b>SCREWS</b>	1	ISO M2.5X6(H=0.7~0.8MM)	86.00E12.536
	1	SCREW M2.5*L8 NYLOK CR3+	86.00E34.738
	1	SCREW 2.5X10 0.8	86.1Z533.100
	1	SCREW M2-3	86.9A522.3R0
	1	SCREW M2*4 WAFER NI	86.9A552.4R0
	1	SCREW MACH WAFER M3*L4 NI	86.9A554.4R0
<b>SPEAKER</b>	2	SPEAKER ON UPPER CASE	23.40543.001
	2	SPEAKER ON UPPER CASE	23.40535.001
	2	SPEAKER ON UPPER CASE	23.40542.001
	2	SPEAKER ON LOWER CASE	23.40536.001
	2	SPEAKER ON LOWER CASE	23.40539.001



9. ACER\_ASPIRE 5738 UMA\_JV50\_MV(NO:91.4CG01.002G)

Category	No.	Part Name	Acer Part No.
<b>CASE/COVER/BRACKET ASSEMBLY</b>	2	LCD COVER 15.6" IMR W/ANTENNA*3 & LOGO (FOR 3G)	TBD
	2	LCD COVER 15.6" IMR W/ANTENNA*3 & LOGO (FOR 3G)	TBD
	1	LOWER CASE W/MODEM CABLE&SPEAKER WITH 3G	TBD
	1	MIDDLE COVER W/3G BUTTON WITH GREEN LIGHT	TBD

10. ACER\_ASPIRE 5738G DIS\_JV50\_MV(NO:91.4CG01.004G)

Category	No.	Part Name	Acer Part No.
<b>CASE/COVER/BRACKET ASSEMBLY</b>	2	LCD COVER 15.6" W/ANTENNA*3 & LOGO (FOR 3G)	TBD
	1	LOWER CASE W/MODEM CABLE&SPEAKER WITH 3G	TBD
	1	MIDDLE COVER W/3G BUTTON WITH GREEN LIGHT	TBD
<b>KEYBOARD</b> 	1	KEYBOARD 103KEYS NSK-ALA0J AC7T JV50 INTERNAL 17 STANDARD BLACK TEXTURE KOREA	TBD
	1	KEYBOARD 103KEYS NSK-ALA0J AC7T JV50 INTERNAL 17 STANDARD BLACK TEXTURE BLANK	TBD
	1	KEYBOARD 104KEYS NSK-ALA0J AC7T JV50 INTERNAL 17 STANDARD BLACK TEXTURE CZECH	TBD
	1	KEYBOARD 104KEYS NSK-ALA0J AC7T JV50 INTERNAL 17 STANDARD BLACK TEXTURE FRENCH CANADIAN	TBD
	1	KEYBOARD 104KEYS NSK-ALA0J AC7T JV50 INTERNAL 17 STANDARD BLACK TEXTURE SLOVAK	TBD
	1	KEYBOARD 104KEYS NSK-ALA0J AC7T JV50 INTERNAL 17 STANDARD BLACK TEXTURE BLANK	TBD
<b>LCD</b>	1	LED LCD MODULE 15.6" WXGA GLARE W/ ANTENNA*3&CAMERA (FOR 3G)	TBD
	1	CCFL LCD MODULE 15.6" WXGA GLARE W/ ANTENNA*3&CAMERA WITH 3G	TBD
	1	LED LCD MODULE 15.6" WXGA GLARE W/ ANTENNA*3&CAMERA (FOR 3G)	TBD
	1	CCFL LCD MODULE 15.6" WXGA GLARE W/ ANTENNA*3&CAMERA (FOR 3G)	TBD

11. ACER\_ASPIRE 5738ZG N10MGE1512CBBM\_JV50\_MV(NO:LX.PAT0X.001)

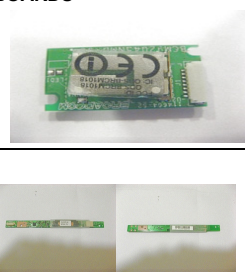

Category	No.	Part Name	Acer Part No.
<b>ADAPTER</b> 	1	ADAPTER 65W 19V 3PIN HIPRO HP-A0652R3B 1LF LV5 LED LF YELLOW	AP.06503.024
	1	ADAPTER 65W 19V 3PIN DELTA ADP-65JH DB A LV5 LED LF YELLOW	AP.0650A.012
	1	ADAPTER 65W 19V 3PIN LITEON PA-1650-22AC LV5 LED LF YELLOW	AP.06501.026
<b>BATTERY</b> 	1	BATTERY PANASONIC AS-2007A LI-ION 3S2P PANASONIC 6 CELL 4400MAH MAIN COMMON PSS	BT.00607.034
	1	BATTERY SONY AS-2007A LI-ION 3S2P SONY 6 CELL 4400MAH MAIN COMMON NORMAL TYPE	BT.00605.020
	1	BATTERY SANYO AS-2007A LI-ION 3S2P SANYO 6 CELL 4400MAH MAIN COMMON NORMAL TYPE	BT.00604.024
	1	BATTERY SIMPLO AS-2007A LI-ION 3S2P PANASONIC 6 CELL 4400MAH MAIN COMMON PSS	BT.00603.041
	1	BATTERY SIMPLO AS-2007A LI-ION 3S2P LGC 6 CELL 2150MAH 2ND COMMON	BT.00607.015
	1	BATTERY SIMPLO AS-2007A LI-ION 3S2P SAMSUNG 6 CELL 4400MAH MAIN COMMON SDI 2.2MAH F TYPE	BT.00607.019
<b>BOARDS</b> 	1	BLUETOOTH BOARD FOXCONN BCM2045 V2 T60H928.11	BT.21100.005
	2	INVERTER BOARD 17" DARFON VK.21189.408	19.21072.081
	2	INVERTER BOARD YEC YNV-W15	19.21066.041

Category	No.	Part Name	Acer Part No.	
<b>BOARDS</b> 	1	LED BUTTON BOARD	TBD	
	1	MINI WLAN/B FOXCONN 802.11BGN ATHEROS XB63 BG T60H976.00 FW:V06 MINICARD	NI.23600.007	
	2	MODEM BOARD FOXCONN DELPHI-AM5 V2H 1.5_3.3V AUS T60M951.36	FX.22500.023	
		1	TOUCHPAD BOARD SYNAPTICS TM00540-005	56.17010.181
		1	TOUCHPAD BOARD ALPS KGDF0038A	56.17024.051
		1	TOUCH PAD BUTTON BOARD	55.PAW01.003
		1	USB BOARD	TBD
		1	WIRELESS LAN BOARD 802.11BGN FOXCONN T77H028.00 RALINK RT2700E 1X2	NI.23600.031
		1	WIRELESS LAN BOARD 802.11BGN QMI EM303-AR ATHEROS AR5B91 1X2 MINICARD	NI.23600.033
		1	WIRELESS LAN BOARD 802.11BGN FOXCONN T77H053.00 ATHEROS AR5B91 1X2	NI.23600.030
<b>CABLES</b>	1	BLUETOOTH BOARD CABLE	50.4CG06.021	
	1	BLUETOOTH BOARD CABLE	50.4CG06.001	
	1	BLUETOOTH BOARD CABLE	50.4CG06.011	
	1	FINGER PRINT / TP BUTTON BAORD CABLE	50.4CG01.001	
	1	FINGER PRINT / TP BUTTON BAORD CABLE	50.4CG01.011	
	2	LCD/CAMERA CABLE	50.4CG13.001	
	2	LCD/CAMERA CABLE	50.4CG13.011	
	2	LCD/CAMERA CABLE	50.4CG13.021	
	2	LCD COVER 15.6" W/ANTENNA*3 & LOGO NONE 3G	TBD	
	2	LED BUTTON BOARD CABLE	50.4CG02.001	
	2	LED BUTTON BOARD CABLE	50.4CG02.011	
	2	LED LCD/CAMERA CABLE	50.4CG14.001	
	2	LED LCD/CAMERA CABLE	50.4CG14.021	
	2	LED LCD/CAMERA CABLE	50.4CG14.031	
	2	MODEM CABLE	50.4CG04.001	
	2	MODEM CABLE	50.4CG04.011	
		1	POWER CORD 3A 250V 3PIN UK	27.03118.001
		1	POWER CORD 5A 250V 3PIN UK BK	27.01518.541
		1	POWER CORD 2.5A 125V USA	27.01518.A11
1		POWER CORD 2.5A 125V 1.8M BLACK TAIWANESE	27.01518.781	
1		POWER CORD 10A 250V SWISS	27.01518.691	

Category	No.	Part Name	Acer Part No.
<b>CABLES</b>	1	POWER CORD 10A 250V 3PIN SWISS BK	27.01518.581
	1	POWER CORD 10A 250V ARGENTINE	27.01518.0U1
	1	POWER CORD 10A 125V US	27.01518.641
	1	POWER CORD 10A 125V 3PIN US BK	27.01518.521
	1	POWER CORD 7A 250V 2PIN KOREAN	27.01518.531
	1	POWER CORD 7A 125V 2PIN JAPAN	27.01518.551
	1	POWER CORD 10A 3PIN BK DENMARK	27.01518.671
	1	POWER CORD 10A 250V 3PIN DENMARK BK	27.01518.561
	1	POWER CORD 10A 250V 3PIN BK SOUTH AFRICA	27.01518.681
	1	POWER CORD 16A 250V SOUTH AFRICA BK	27.01518.571
	1	POWER CORD 10A 250V 3PIN CHINA	27.01518.701
	1	POWER CORD 10A 250V 3PIN CHINA BK	27.01518.591
	1	POWER CORD 250V 3PIN EUR BK	27.01518.731
	1	POWER CABLE 16A 250V 3PIN EUR BK	27.01518.601
	1	POWER CORD 10A 250V 3PIN ITALY	27.01518.711
	1	POWER CORD 10A 250V 3PIN ITALY BK	27.01518.611
	1	POWER CORD 2.5A 250V AUSTRALIA	27.01518.621
	1	POWER CORD 2.5A 250V SOUTH AFRICA BK (INDIA)	27.01518.721
	1	POWER CORD 10A 250V SOUTH AFRICA BK (INDIA)	27.01518.631
	1	POWER CORD 7A 125V 2PIN JAPAN BK	27.01518.661
	1	POWER CORD 250V 10A 3PIN ISRAEL	27.01518.761
	1	POWER CORD 10A 250V 1.8M BRAZIL BLK	27.01518.A41
	1	POWER CORD ACA / ACNZ	27.03218.051
	1	POWER CORD 7.5A 250V 3P AUSTRALIA BK	27.03218.021
	1	POWER CODE 7A 125V 2PIN JAPAN	27.03518.161
	1	TOUCHPAD CABLE	50.4CG03.011
	1	TOUCHPAD CABLE	50.4CG03.001
	1	USB BOARD CABLE	50.4CG05.021
	1	USB BOARD CABLE	50.4CG05.001
	1	USB BOARD CABLE	50.4CG05.011
<b>CAMERA</b> 	2	CAMERA 0.3M CHICONY CNF701721004973L	56.18012.094
		2	CAMERA 0.3M SUYIN CN0314-SN30-OV03-5
<b>CASE/COVER/BRACKET ASSEMBLY</b> 	2	BLUE-RAY COMBO BEZEL	42.PAW01.005
	2	DVD-RW SUPER-MULTI BEZEL	42.PAW01.004
	2	LCD BEZEL 15.6" W/CAMERA HOLE	60.PAW01.004
	2	LCD BRACKET W/HINGE RIGHT	34.4K808.021
	2	LCD BRACKET W/HINGE RIGHT	34.4K808.001
	2	LCD BRACKET W/HINGE RIGHT	34.4K808.011

Category	No.	Part Name	Acer Part No.
<b>CASE/COVER/BRACKET ASSEMBLY</b>	2	LCD BRACKET W/HINGE LEFT	34.4K809.021
	2	LCD BRACKET W/HINGE LEFT	34.4K809.001
	2	LCD BRACKET W/HINGE LEFT	34.4K809.011
	2	LCD COVER 15.6" W/ANTENNA*3 & LOGO NONE 3G	TBD
	2	LCD COVER 15.6" W/ANTENNA*2 & LOGO NONE 3G	TBD
	2	LED LCD BRACKET RIGHT W/HINGE	34.4CG12.001
	2	LED LCD BRACKET RIGHT W/HINGE	34.4CG12.011
	2	LED LCD BRACKET RIGHT W/HINGE	34.4CG12.021
	2	LED LCD BRACKET LEFT W/HINGE	34.4CG13.001
	2	LED LCD BRACKET LEFT W/HINGE	34.4CG13.011
	2	LED LCD BRACKET LEFT W/HINGE	34.4CG13.021
	1	LOWER CASE W/MODEM CABLE&SPEAKER NONE 3G	60.PAW01.001
	1	MIDDLE COVER W/BLUETOOTH BUTTON WITH BLUE LIGHT NONE 3G	TBD
	2	OPTICAL BRACKET	33.PAW01.002
	1	SD DUMMY CARD	42.TKJ01.001
	1	TOUCHPAD BRACKET	33.PAW01.001
	1	UPPER CASE W/LED BUTTON BOARD CABLE&MICROPHONE&SPEAKER W/O FINGER PRINT HOLE	60.PAW01.002
	1	UNITLOAD COVER	42.PAW01.002
	1	WIRELESS LAN COVER	42.PAW01.003
	1	CPU INTEL PENTIUM DUAL-CORE T4200 PGA 2.0G 1M 800 35W R-0	KC.42001.DTP
	1	CPU INTEL MEROM PENTIUM DUAL-CORE T3400 2.16G 1M 667 MV	KC.34001.DTP



Category	No.	Part Name	Acer Part No.
<b>HDD/HARD DISK DRIVE</b> 	2	HDD 160GB 5400RPM SATA WD WD1600BEVT-22ZCT0 FW:11.01A11	KH.16007.019
	2	HDD 160GB 5400RPM SATA SEAGATE ST9160310AS F/W:2010	KH.16008.022
	2	HDD 160GB 5400RPM SATA TOSHIBA LIBRA-BS MK1655GSX F/W:FG0101J 5.4	KH.16001.034
	2	HDD 160GB 5400RPM SATA HGST HTS543216L9A300 F/W:C30C	KH.16004.006
	1	HDD MODULE 250GB 5400RPM SATA	
	2	HDD 250GB 5400RPM SATA WD WD2500BEVT-22ZCT0 F/W:11.01A11	KH.25004.003
	2	HDD 250GB 5400RPM SATA HGST HTS545025B9A300 PANTHER-B LF F/W:C50K	KH.25008.021
	2	HDD 250GB 5400RPM SATA SEAGATE ST9250315AS LF F/W:0001SDM1	KH.25007.015
	2	HDD 250GB 5400RPM SATA TOSHIBA LIBRA-BS MK2555GSX F/W:FG000J 5.4K	KH.25001.016
	1	HDD MODULE 320GB 5400RPM SATA	
	2	HDD 320GB 5400RPM SATA HGST HTS545032B9A300 PANTHER B LF	KH.32008.013
	2	HDD 320GB 5400RPM SATA SEAGATE ST9320320AS F/W:2010	KH.32007.007
	2	HDD 320GB 5400RPM SATA TOSHIBA MK3255GSX LIBRA LF F/W:FG010J	KH.32001.008
	2	HDD 320GB 5400RPM SATA WD WD3200BEVT-22ZCT0 ML125 F/W:01.01A01	KH.32004.002
	1	HDD MODULE 500GB 5400RPM SATA	
	2	HDD SEAGATE 2.5" 5400RPM 500GB ST9500325AS SATA LF F/W:0001SDM1	KH.50008.013
	2	HDD 500GB 5400RPM SATA TOSHIBA MK5055GSX LIBRA-BS F/W:FG000J LF	KH.50001.011
	2	HDD 500GB 5400RPM HGST SATA HTS545050B9A300 PANTHER B LF	KH.50004.001
	2	HDD WD 2.5" 500GB 5400RPM SATA WD5000BEVT-22ZAT0 F/W:01.01A01	KH.50007.009
	<b>HEATSINK</b> 	1	CPU HEATSINK W/FAN
1		CPU HEATSINK W/FAN	60.4CG27.001
1		CPU HEATSINK W/FAN	60.4CG15.001
<b>KEYBOARD</b> 	1	KEYBOARD 104KEYS NSK-ALA0J AC7T JV50 INTERNAL 17 STANDARD BLACK TEXTURE UK	KB.1170A.055
	1	KEYBOARD 103KEYS NSK-ALA0J AC7T JV50 INTERNAL 17 STANDARD BLACK TEXTURE US-INTERNATIONAL	KB.1170A.056
	1	KEYBOARD 107KEYS NSK-ALA0J AC7T JV50 INTERNAL 17 STANDARD BLACK TEXTURE JAPANESE	KB.1170A.044
	1	KEYBOARD 103KEYS NSK-ALA0J AC7T JV50 INTERNAL 17 STANDARD BLACK TEXTURE GREEK	KB.1170A.041
	1	KEYBOARD 103KEYS NSK-ALA0J AC7T JV50 INTERNAL 17 STANDARD BLACK TEXTURE TAIWAN	KB.1170A.036
	1	KEYBOARD 103KEYS NSK-ALA0J AC7T JV50 INTERNAL 17 STANDARD BLACK TEXTURE THAILAND	KB.1170A.053
	1	KEYBOARD 103KEYS NSK-ALA0J AC7T JV50 INTERNAL 17 STANDARD BLACK TEXTURE HEBREW	KB.1170A.057
	1	KEYBOARD 103KEYS NSK-ALA0J AC7T JV50 INTERNAL 17 STANDARD BLACK TEXTURE ARABIC	KB.1170A.032
	1	KEYBOARD 103KEYS NSK-ALA0J AC7T JV50 INTERNAL 17 STANDARD BLACK TEXTURE RUSSIAN	KB.1170A.048
	1	KEYBOARD 103KEYS NSK-ALA0J AC7T JV50 INTERNAL 17 STANDARD BLACK TEXTURE KOREA	TBD

Category	No.	Part Name	Acer Part No.
<b>KEYBOARD</b>	1	KEYBOARD 103KEYS NSK-ALA0J AC7T JV50 INTERNAL 17 STANDARD BLACK TEXTURE BLANK	TBD
	1	KEYBOARD 104KEYS NSK-ALA0J AC7T JV50 INTERNAL 17 STANDARD BLACK TEXTURE SWEDISH	KB.I170A.051
	1	KEYBOARD 104KEYS NSK-ALA0J AC7T JV50 INTERNAL 17 STANDARD BLACK TEXTURE FRENCH	KB.I170A.039
	1	KEYBOARD 104KEYS NSK-ALA0J AC7T JV50 INTERNAL 17 STANDARD BLACK TEXTURE PORTUGAL	KB.I170A.047
	1	KEYBOARD 104KEYS NSK-ALA0J AC7T JV50 INTERNAL 17 STANDARD BLACK TEXTURE SLOVE	KB.I170A.049
	1	KEYBOARD 104KEYS NSK-ALA0J AC7T JV50 INTERNAL 17 STANDARD BLACK TEXTURE BRAZILIAN PORTUGUESE	KB.I170A.034
	1	KEYBOARD 104KEYS NSK-ALA0J AC7T JV50 INTERNAL 17 STANDARD BLACK TEXTURE SWISS	KB.I170A.052
	1	KEYBOARD 104KEYS NSK-ALA0J AC7T JV50 INTERNAL 17 STANDARD BLACK TEXTURE DANISH	KB.I170A.037
	1	KEYBOARD 104KEYS NSK-ALA0J AC7T JV50 INTERNAL 17 STANDARD BLACK TEXTURE ITALIAN	KB.I170A.043
	1	KEYBOARD 104KEYS NSK-ALA0J AC7T JV50 INTERNAL 17 STANDARD BLACK TEXTURE BELGIAN	KB.I170A.033
	1	KEYBOARD 104KEYS NSK-ALA0J AC7T JV50 INTERNAL 17 STANDARD BLACK TEXTURE GERMAN	KB.I170A.040
	1	KEYBOARD 104KEYS NSK-ALA0J AC7T JV50 INTERNAL 17 STANDARD BLACK TEXTURE CZECH	TBD
	1	KEYBOARD 104KEYS NSK-ALA0J AC7T JV50 INTERNAL 17 STANDARD BLACK TEXTURE FRENCH CANADIAN	TBD
	1	KEYBOARD 104KEYS NSK-ALA0J AC7T JV50 INTERNAL 17 STANDARD BLACK TEXTURE NORWEGIAN	KB.I170A.046
	1	KEYBOARD 104KEYS NSK-ALA0J AC7T JV50 INTERNAL 17 STANDARD BLACK TEXTURE HUNGARIAN	KB.I170A.042
	1	KEYBOARD 104KEYS NSK-ALA0J AC7T JV50 INTERNAL 17 STANDARD BLACK TEXTURE SPANISH	KB.I170A.050
	1	KEYBOARD 104KEYS NSK-ALA0J AC7T JV50 INTERNAL 17 STANDARD BLACK TEXTURE TURKISH	KB.I170A.054
	1	KEYBOARD 104KEYS NSK-ALA0J AC7T JV50 INTERNAL 17 STANDARD BLACK TEXTURE NORDIC	KB.I170A.045
	1	KEYBOARD 104KEYS NSK-ALA0J AC7T JV50 INTERNAL 17 STANDARD BLACK TEXTURE FRENCH ARABIC	KB.I170A.038
	1	KEYBOARD 104KEYS NSK-ALA0J AC7T JV50 INTERNAL 17 STANDARD BLACK TEXTURE FRENCH CANADIAN	KB.I170A.058
1	KEYBOARD 104KEYS NSK-ALA0J AC7T JV50 INTERNAL 17 STANDARD BLACK TEXTURE CZECH/SLOVAK	KB.I170A.035	
1	KEYBOARD 104KEYS NSK-ALA0J AC7T JV50 INTERNAL 17 STANDARD BLACK TEXTURE SLOVAK	TBD	
1	KEYBOARD 104KEYS NSK-ALA0J AC7T JV50 INTERNAL 17 STANDARD BLACK TEXTURE BLANK	TBD	
<b>LCD</b> 	2	LCD AUO 15.6" WXGA GLARE AUO B156XW01 V0 LF 220NIT 8MS	LK.1560D.001
	2	LCD AUO 15.6" WXGA GLARE LG LP156WH1-TLA1 LF 220NIT 8MS 400:1	LK.15605.001
	2	LCD AUO 15.6" WXGA GLARE CMO N156B3-L02 LF 220NIT 8MS	LK.15608.001
	1	LCD MODULE 15.6" WXGA GLARE W/ANTENNA*2&CAMERA (NONE 3G)	
	1	LCD MODULE 15.6" WXGA GLARE W/ANTENNA*3&CAMERA (NONE 3G)	
	2	LED LCD 15.6" WXGA GLARE CMO N156B6-L04 LF 220NIT 8MS 500:1	LK.15608.002
	2	LED LCD 15.6" WXGA GLARE AUO B156XW02 V0 LF 220NIT 8MS 500:1	LK.15606.003
	2	LED LCD 15.6" WXGA GLARE SAMSUNG LTN156AT02-A01 LF 220NIT 8MS 500:1	LK.1560D.005

Category	No.	Part Name	Acer Part No.
<b>LCD</b>	2	LED LCD 15.6" WXGA GLARE LG LP156WH2-TLE1 LF 220NIT 8MS 400:1	LK.15605.003
	1	LED MODULE 15.6" WXGA GLARE W/ANTENNA*2&CAMERA (NONE 3G)	
	1	LED MODULE 15.6" WXGA GLARE W/ANTENNA*3&CAMERA (NONE 3G)	
<b>MAINBOARD</b> 	1	MAINBOARD JV50_MV DIS GM45 ICH9M NVIDIA N10MGE1 VRAM SAMSUNG DDRII500 1GB LF W/RTC BATTERY&MODEM BOARD NONE 3G	TBD
<b>MEMORY</b> 	1	SODIMM 1GB DDRLLL 1066MHZ HYNIX HMT112S6AFP6C-G7N0	KN.1GB0B.028
	1	SODIMM 1GB DDRIII 1066MHZ SAMSUNG M471B2874DZ1-CF8	KN.1GB0G.019
	1	SODIMM 1GB DDRIII 1066MHZ MICRON MT8JSF12864HY-1G1D1	KN.1GB0B.019
	1	SODIMM 1GB DDRLLL 1066MHZ ELPIDA EBJ11UE6BBS0-AE-F	KN.1GB04.003
	1	SODIMM 1GB DDRLLL 1066MHZ SAMSUNG M471B2873EH1-CF8	KN.1GB09.011
	1	SODIMM 2GB DDRLLL 1066MHZ HYNIX HMT125S6AFP8C-G7N0	KN.2GB0B.012
	1	SODIMM 2GB DDRIII 1066MHZ SAMSUNG M471B5673DZ1-CF8	KN.2GB0G.009
	1	SODIMM 2GB DDRIII 1066MHZ MICRON MT16JSF25664HY-1G1D1	KN.2GB0B.005
	1	SODIMM 2GB DDRLLL 1066MHZ ELPIDA EBJ21UE8BBS0-AE-F	KN.2GB04.004
	1	SODIMM 2GB DDRLLL 1066MHZ SAMSUNG M471B5673EH1-CF8	KN.2GB09.004
<b>MICROPHONE</b>	2	MICROPHONE	23.42239.001
	2	MICROPHONE	23.42231.001
	2	MICROPHONE	23.40544.001
	2	MICROPHONE	23.42238.001
<b>MISCELLANEOUS</b> 	1	LCD SCREW RUBBER	47.AU401.001
	1	NAME PLATE AS5738Z	TBD
	1	LCD COVER SPONGE LEFT	TBD
	1	LCD COVER SPONGE RIGHT	TBD
<b>ODD MODULE</b> 	1	BLU-RAY COMBO MODULE 4X SATA	
	1	DVD-RW SUPER-MULTI MODULE 8X SATA	
	2	ODD PLDS BD COMBO 12.7MM TRAY DL 4X DS-4E1S LF W/O BEZEL SATA	KO.0040D.002
	2	ODD PIONEER BD COMBO 12.7 SATA DL 4X BDC-TD01RS LF W/O BEZEL SATA	KO.0040F.001
	2	ODD HLDS BD COMBO 12.7MM TRAY DL 4X CT10 LF W/O BEZEL SATA	KO.00405.002
	2	ODD SONY SUPER-MULTI DRIVE 12.7MM TRAY DL 8X AD-7580S LF W/O BEZEL SATA	KU.0080D.040
	2	ODD TOSHIBA SUPER-MULTI DRIVE 12.7MM TRAY DL 8X SATA TS-L633B LF W/O BEZEL	KU.0080F.004
	2	ODD SONY SUPER-MULTI DRIVE 12.7MM TRAY DL 8X AD-7590S LF W/O BEZEL SATA	KU.00801.030
	2	ODD HLDS SUPER-MULTI DRIVE 12.7MM TRAY DL 8X GT20N LF W/O BEZEL SATA	KU.0080E.025
	2	ODD PLDS SUPER-MULTI DRIVE 12.7MM TRAY DL 8X SATA DS-8A3S LF W/O BEZEL	KU.0080D.040



Category	No.	Part Name	Acer Part No.
<b>SCREWS</b>	1	ISO M2.5X6(H=0.7~0.8MM)	86.00E12.536
	1	SCREW M2.5*L8 NYLOK CR3+	86.00E34.738
	1	SCREW 2.5X10 0.8	86.1Z533.100
	1	SCREW M2-3	86.9A522.3R0
	1	SCREW M2*4 WAFER NI	86.9A552.4R0
	1	SCREW MACH WAFER M3*L4 NI	86.9A554.4R0
<b>SPEAKER</b>	2	SPEAKER ON UPPER CASE	23.40543.001
	2	SPEAKER ON UPPER CASE	23.40535.001
	2	SPEAKER ON UPPER CASE	23.40542.001
	2	SPEAKER ON LOWER CASE	23.40536.001
	2	SPEAKER ON LOWER CASE	23.40539.001



12. ACER\_ASPIRE 5536 UMACBDBM\_JV50\_PU(NO:91.4CH01.004G)

Category	No.	Part Name	Acer Part No.	
<b>ADAPTER</b> 	1	ADAPTER 65W 19V 3PIN HIPRO HP-A0652R3B 1LF LV5 LED LF YELLOW	AP.06503.024	
	1	ADAPTER 65W 19V 3PIN DELTA ADP-65JH DB A LV5 LED LF YELLOW	AP.0650A.012	
	1	ADAPTER 65W 19V 3PIN LITEON PA-1650-22AC LV5 LED LF YELLOW	AP.06501.026	
<b>BATTERY</b> 	1	BATTERY SIMPLO AS-2007A LI-ION 3S2P LGC 6 CELL 2150MAH 2ND COMMON	BT.00607.034	
	1	BATTERY SONY AS-2007A LI-ION 3S2P SONY 6 CELL 4400MAH MAIN COMMON NORMAL TYPE	BT.00607.019	
	1	BATTERY SANYO AS-2007A LI-ION 3S2P SANYO 6 CELL 4400MAH MAIN COMMON NORMAL TYPE	BT.00604.024	
	1	BATTERY PANASONIC AS-2007A LI-ION 3S2P PANASONIC 6 CELL 4400MAH MAIN COMMON PSS	BT.00603.041	
	1	BATTERY SIMPLO AS-2007A LI-ION 3S2P PANASONIC 6 CELL 4400MAH MAIN COMMON PSS	BT.00605.020	
	1	BATTERY SIMPLO AS-2007A LI-ION 3S2P SAMSUNG 6 CELL 4400MAH MAIN COMMON SDI 2.2MAH F TYPE	BT.00607.015	
<b>BOARDS</b> 	1	BLUETOOTH BOARD FOXCONN BCM2045 V2 T60H928.11	BT.21100.005	
		1	LED BUTTON BOARD	55.PAW01.001
		1	MINI WLAN/B FOXCONN 802.11BGN ATHEROS XB63 BG T60H976.00 FW:V06 MINICARD	NI.23600.007
		2	MODEM BOARD LITEON CONEXANT -UNIZION 1.5_3.3V AUS B85247600G	
		1	TOUCHPAD BOARD SYNAPTICS TM00540-005	56.17010.181

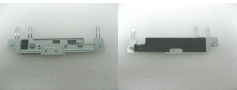
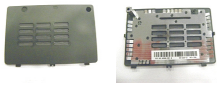
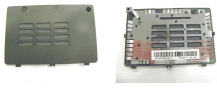

Category	No.	Part Name	Acer Part No.
<b>BOARDS</b> 	1	TOUCHPAD BOARD ALPS KGDF0038A	56.17024.051
	1	TOUCH PAD BUTTON BOARD	55.PAW01.003
	1	USB BOARD	55.PAW01.002
	1	WIRELESS LAN BOARD 802.11BGN QMI EM303-AR Atheros AR5B91 1X2 MINICARD	NI.23600.033
	1	WIRELESS LAN BOARD 802.11BGN FOXCONN T77H053.00 Atheros AR5B91 1X2	NI.23600.030
<b>CABLES</b>	1	BLUETOOTH BOARD CABLE	50.4CG06.021
	1	BLUETOOTH BOARD CABLE	50.4CG06.001
	1	BLUETOOTH BOARD CABLE	50.4CG06.011
	1	FINGER PRINT / TP BUTTON BAORD CABLE	50.4CG01.011
	1	FINGER PRINT / TP BUTTON BAORD CABLE	50.4CG01.001
	2	LED BUTTON BOARD CABLE	50.4CG02.001
	2	LED BUTTON BOARD CABLE	50.4CG02.011
	2	LED LCD/CAMERA CABLE	50.4CG14.001
	2	LED LCD/CAMERA CABLE	50.4CG14.021
	2	LED LCD/CAMERA CABLE	50.4CG14.031
	2	MODEM CABLE	50.4CG04.001
	2	MODEM CABLE	50.4CG04.011
	1	POWER CORD 2.5A 125V USA	27.01518.A11
	1	POWER CORD 2.5A 125V 1.8M BLACK TAIWANESE	27.01518.781
	1	POWER CORD 10A 250V SWISS	27.01518.691
	1	POWER CORD 10A 250V 3PIN SWISS BK	27.01518.581
	1	POWER CORD 10A 250V ARGENTINE	27.01518.0U1
	1	POWER CORD 10A 125V US	27.01518.641
	1	POWER CORD 10A 125V 3PIN US BK	27.01518.521
	1	POWER CORD 7A 250V 2PIN KOREAN	27.01518.531
	1	POWER CORD 3A 250V 3PIN UK	27.03118.001
	1	POWER CORD 5A 250V 3PIN UK BK	27.01518.541
	1	POWER CORD 7A 125V 2PIN JAPAN	27.01518.551
	1	POWER CORD 10A 3PIN BK DENMARK	27.01518.671
	1	POWER CORD 10A 250V 3PIN DENMARK BK	27.01518.561
	1	POWER CORD 10A 250V 3PIN BK SOUTH AFRICA	27.01518.681
	1	POWER CORD 16A 250V SOUTH AFRICA BK	27.01518.571
	1	POWER CORD 10A 250V 3PIN CHINA	27.01518.701
	1	POWER CORD 10A 250V 3PIN CHINA BK	27.01518.591
	1	POWER CORD 250V 3PIN EUR BK	27.01518.731
	1	POWER CABLE 16A 250V 3PIN EUR BK	27.01518.601
	1	POWER CORD 10A 250V 3PIN ITALY	27.01518.711
1	POWER CORD 10A 250V 3PIN ITALY BK	27.01518.611	
1	POWER CORD 2.5A 250V AUSTRALIA	27.01518.621	

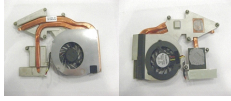
Category	No.	Part Name	Acer Part No.
<b>CABLES</b>	1	POWER CORD 2.5A 250V SOUTH AFRICA BK (INDIA)	27.01518.721
	1	POWER CORD 10A 250V SOUTH AFRICA BK (INDIA)	27.01518.631
	1	POWER CORD 7A 125V 2PIN JAPAN BK	27.01518.661
	1	POWER CORD 250V 10A 3PIN ISRAEL	27.01518.761
	1	POWER CORD 10A 250V 1.8M BRAZIL BLK	27.01518.A41
	1	POWER CORD ACA / ACNZ	27.03218.051
	1	POWER CORD 7.5A 250V 3P AUSTRALIA BK	27.03218.021
	1	POWER CORD 7A 125V 2PIN JAPAN	27.03518.161
	1	TOUCHPAD CABLE	50.4CG03.001
	1	TOUCHPAD CABLE	50.4CG03.011
	1	USB BOARD CABLE	50.4CG05.001
	1	USB BOARD CABLE	50.4CG05.011
	1	USB BOARD CABLE	50.4CG05.021
<b>CAMERA</b> 	2	CAMERA 0.3M CHICONY CNF701721004973L	56.18012.094
	2	CAMERA 0.3M SUYIN CN0314-SN30-OV03-5	56.18007.094
<b>CASE/COVER/BRACKET ASSEMBLY</b> 	2	BLUE-RAY COMBO BEZEL	42.PAW01.005
	2	DVD-RW SUPER-MULTI BEZEL	42.PAW01.004
	2	HDD BRACKET	33.PAW01.003
	2	LCD BEZEL 15.6" W/CAMERA HOLE	60.PAW01.004
	2	LED LCD BRACKET RIGHT W/HINGE	34.4CG12.001
	2	LED LCD BRACKET RIGHT W/HINGE	34.4CG12.011
	2	LED LCD BRACKET RIGHT W/HINGE	34.4CG12.021
	2	LED LCD BRACKET LEFT W/HINGE	34.4CG13.001
	2	LED LCD BRACKET LEFT W/HINGE	34.4CG13.011
	2	LED LCD BRACKET LEFT W/HINGE	34.4CG13.021
	2	LED LCD COVER IMR 15.6" W/ANTENNA*2 & LOGO NONE 3G	60.PAW01.005
	2	LED LCD COVER IMR 15.6" W/LOGO W/O ANTENNA&3G	60.PAW01.006
	1	LOWER CASE W/MODEM CABLE&SPEAKER	60.PAW01.001
	1	MIDDLE COVER W/BLUETOOTH BUTTON WITH BLUE LIGHT NONE 3G BUTTON	42.PAW01.001
			

Category	No.	Part Name	Acer Part No.
<b>CASE/COVER/BRACKET ASSEMBLY</b> 	2	OPTICAL BRACKET	33.PAW01.002
	1	SD DUMMY CARD	42.TKJ01.001
	1	TOUCHPAD BRACKET	33.PAW01.001
	1	UNITLOAD COVER	42.PAW01.002
	1	UPPER CASE W/LED BUTTON BOARD CABLE&MICROPHONE&SPEAKER W/O FINGER PRINT HOLE	60.PAW01.002
	1	WIRELESS LAN COVER	42.PAW01.003
<b>CPU/PROCESSOR</b> 	1	CPU AMD ATHLON64X2 QL62 PGA 2.0G 1M 638 35W GRIFFIN B1	KC.AQL02.620
	1	CPU AMD ATHLON64X2 QL-64 2.1G 638 35W GRIFFIN B1	KC.AQL02.640
	1	CPU AMD ATHLON QL65 PGA 2.1G 1M 638 35W GRIFFIN B1	KC.AQL02.650
	1	CPU AMD TURION RM72 PGA 2.1G 1M 638 35W GRIFFIN B1	KC.TRM02.720
	1	CPU AMD TURION RM-74 2.2G 1M 638 35W GRIFFIN B1	KC.TRM02.740
	1	CPU AMD TURION RM75 PGA 2.2G 1M 638 35W GRIFFIN B1	KC.TRM02.750
<b>HDD/HARD DISK DRIVE</b> 	1	HDD MODULE 160GB 5400RPM SATA	
	2	HDD 160GB 5400RPM SATA WD WD1600BEVT-22ZCT0 FW:11.01A11	KH.16007.019
	2	HDD 160GB 5400RPM SATA SEAGATE ST9160310AS F/W:2010	KH.16008.022
	2	HDD 160GB 5400RPM SATA TOSHIBA LIBRA-BS MK1655GSX F/ W:FG0101J 5.4	KH.16001.034
	2	HDD 160GB 5400RPM SATA HGST HTS543216L9A300 F/ W:C30C	KH.16004.006
	1	HDD MODULE 250GB 5400RPM SATA	
	2	HDD 250GB 5400RPM SATA HGST HTS545025B9A300 PANTHER-B LF F/W:C50K	KH.25008.021
	2	HDD 250GB 5400RPM SATA SEAGATE ST9250315AS LF F/ W:0001SDM1	KH.25007.015
	2	HDD 250GB 5400RPM SATA TOSHIBA LIBRA-BS MK2555GSX F/ W:FG000J 5.4K	KH.25001.016
	2	HDD 250GB 5400RPM SATA WD WD2500BEVT-22ZCT0 F/ W:11.01A11	KH.25004.003
	1	HDD MODULE 320GB 5400RPM SATA	
	2	HDD 320GB 5400RPM SATA HGST HTS545032B9A300 PANTHER B LF	KH.32008.013
	2	HDD 320GB 5400RPM SATA SEAGATE ST9320320AS F/W:2010	KH.32007.007
	2	HDD 320GB 5400RPM SATA TOSHIBA MK3255GSX LIBRA LF F/ W:FG010J	KH.32001.008

Category	No.	Part Name	Acer Part No.
<b>HDD/HARD DISK DRIVE</b>	2	HDD 320GB 5400RPM SATA WD WD3200BEVT-22ZCT0 ML125 F/W:01.01A01	KH.32004.002
	1	HDD MODULE 500GB 5400RPM SATA	
	2	HDD 500GB 5400RPM HGST SATA HTS545050B9A300 PANTHER B LF	KH.50008.013
	2	HDD SEAGATE 2.5" 5400RPM 500GB ST9500325AS SATA LF F/ W:0001SDM1	KH.50007.009
	2	HDD 500GB 5400RPM SATA TOSHIBA MK5055GSX LIBRA-BS F/ W:FG000J LF	KH.50001.011
	2	HDD WD 2.5" 500GB 5400RPM SATA WD5000BEVT-22ZAT0 F/ W:01.01A01	KH.50004.001
<b>HEATSINK</b> 	1	CPU HEATSINK UMA W/FAN	60.4CH17.001
	1	CPU HEATSINK UMA W/FAN	60.4CH11.001
	1	CPU HEATSINK UMA W/FAN	60.4CH04.001
<b>KEYBOARD</b> 	1	KEYBOARD 107KEYS NSK-ALA0J AC7T JV50 INTERNAL 17 STANDARD BLACK TEXTURE JAPANESE	KB.1170A.044
	1	KEYBOARD 104KEYS NSK-ALA0J AC7T JV50 INTERNAL 17 STANDARD BLACK TEXTURE UK	KB.1170A.055
	1	KEYBOARD 103KEYS NSK-ALA0J AC7T JV50 INTERNAL 17 STANDARD BLACK TEXTURE US-INTERNATIONAL	KB.1170A.056
	1	KEYBOARD 103KEYS NSK-ALA0J AC7T JV50 INTERNAL 17 STANDARD BLACK TEXTURE GREEK	KB.1170A.041
	1	KEYBOARD 103KEYS NSK-ALA0J AC7T JV50 INTERNAL 17 STANDARD BLACK TEXTURE TAIWAN	KB.1170A.036
	1	KEYBOARD 103KEYS NSK-ALA0J AC7T JV50 INTERNAL 17 STANDARD BLACK TEXTURE THAILAND	KB.1170A.053
	1	KEYBOARD 103KEYS NSK-ALA0J AC7T JV50 INTERNAL 17 STANDARD BLACK TEXTURE HEBREW	KB.1170A.057
	1	KEYBOARD 103KEYS NSK-ALA0J AC7T JV50 INTERNAL 17 STANDARD BLACK TEXTURE ARABIC	KB.1170A.032
	1	KEYBOARD 103KEYS NSK-ALA0J AC7T JV50 INTERNAL 17 STANDARD BLACK TEXTURE RUSSIAN	KB.1170A.048
	1	KEYBOARD 103KEYS NSK-ALA0J AC7T JV50 INTERNAL 17 STANDARD BLACK TEXTURE KOREA	TBD
	1	KEYBOARD 103KEYS NSK-ALA0J AC7T JV50 INTERNAL 17 STANDARD BLACK TEXTURE BLANK	TBD
	1	KEYBOARD 104KEYS NSK-ALA0J AC7T JV50 INTERNAL 17 STANDARD BLACK TEXTURE SWEDISH	KB.1170A.051
	1	KEYBOARD 104KEYS NSK-ALA0J AC7T JV50 INTERNAL 17 STANDARD BLACK TEXTURE FRENCH	KB.1170A.039
	1	KEYBOARD 104KEYS NSK-ALA0J AC7T JV50 INTERNAL 17 STANDARD BLACK TEXTURE PORTUGAL	KB.1170A.047
	1	KEYBOARD 104KEYS NSK-ALA0J AC7T JV50 INTERNAL 17 STANDARD BLACK TEXTURE SLOVE	KB.1170A.049
	1	KEYBOARD 104KEYS NSK-ALA0J AC7T JV50 INTERNAL 17 STANDARD BLACK TEXTURE BRAZILIAN PORTUGUESE	KB.1170A.034
	1	KEYBOARD 104KEYS NSK-ALA0J AC7T JV50 INTERNAL 17 STANDARD BLACK TEXTURE SWISS	KB.1170A.052
	1	KEYBOARD 104KEYS NSK-ALA0J AC7T JV50 INTERNAL 17 STANDARD BLACK TEXTURE DANISH	KB.1170A.037
	1	KEYBOARD 104KEYS NSK-ALA0J AC7T JV50 INTERNAL 17 STANDARD BLACK TEXTURE ITALIAN	KB.1170A.043
	1	KEYBOARD 104KEYS NSK-ALA0J AC7T JV50 INTERNAL 17 STANDARD BLACK TEXTURE BELGIAN	KB.1170A.033
	1	KEYBOARD 104KEYS NSK-ALA0J AC7T JV50 INTERNAL 17 STANDARD BLACK TEXTURE GERMAN	KB.1170A.040
1	KEYBOARD 104KEYS NSK-ALA0J AC7T JV50 INTERNAL 17 STANDARD BLACK TEXTURE CZECH	TBD	





Category	No.	Part Name	Acer Part No.
<b>KEYBOARD</b>	1	KEYBOARD 104KEYS NSK-ALA0J AC7T JV50 INTERNAL 17 STANDARD BLACK TEXTURE FRENCH CANADIAN	TBD
	1	KEYBOARD 104KEYS NSK-ALA0J AC7T JV50 INTERNAL 17 STANDARD BLACK TEXTURE NORWEGIAN	KB.I170A.046
	1	KEYBOARD 104KEYS NSK-ALA0J AC7T JV50 INTERNAL 17 STANDARD BLACK TEXTURE HUNGARIAN	KB.I170A.042
	1	KEYBOARD 104KEYS NSK-ALA0J AC7T JV50 INTERNAL 17 STANDARD BLACK TEXTURE SPANISH	KB.I170A.050
	1	KEYBOARD 104KEYS NSK-ALA0J AC7T JV50 INTERNAL 17 STANDARD BLACK TEXTURE TURKISH	KB.I170A.054
	1	KEYBOARD 104KEYS NSK-ALA0J AC7T JV50 INTERNAL 17 STANDARD BLACK TEXTURE NORDIC	KB.I170A.045
	1	KEYBOARD 104KEYS NSK-ALA0J AC7T JV50 INTERNAL 17 STANDARD BLACK TEXTURE FRENCH ARABIC	KB.I170A.038
	1	KEYBOARD 104KEYS NSK-ALA0J AC7T JV50 INTERNAL 17 STANDARD BLACK TEXTURE FRENCH CANADIAN	KB.I170A.058
	1	KEYBOARD 104KEYS NSK-ALA0J AC7T JV50 INTERNAL 17 STANDARD BLACK TEXTURE CZECH/SLOVAK	KB.I170A.035
	1	KEYBOARD 104KEYS NSK-ALA0J AC7T JV50 INTERNAL 17 STANDARD BLACK TEXTURE SLOVAK	TBD
	1	KEYBOARD 104KEYS NSK-ALA0J AC7T JV50 INTERNAL 17 STANDARD BLACK TEXTURE BLANK	TBD
	<b>LCD</b> 	1	LED LCD MODULE 15.6" WXGA GLARE W/ ANTENNA*2&CAMERA (NONE 3G)
2		LED LCD 15.6" WXGA GLARE LG LP156WH2-TLE1 LF 220NIT 8MS 400:1	LK.15606.003
2		LED LCD 15.6" WXGA GLARE AUO B156XW02 V0 LF 220NIT 8MS 500:1	LK.15608.002
2		LED LCD 15.6" WXGA GLARE CMO N156B6-L04 LF 220NIT 8MS 500:1	LK.15605.003
2		LED LCD 15.6" WXGA GLARE SAMSUNG LTN156AT02-A01 LF 220NIT 8MS 500:1	LK.1560D.005
1		LED LCD MODULE 15.6" WXGA GLARE W/CAMERA W/O ANTENNA (NONE 3G)	6M.PAW01.004
2		LED LCD 15.6" WXGA GLARE CMO N156B6-L04 LF 220NIT 8MS 500:1	LK.15608.002
2		LED LCD 15.6" WXGA GLARE SAMSUNG LTN156AT02-A01 LF 220NIT 8MS 500:1	LK.1560D.005
2		LED LCD 15.6" WXGA GLARE AUO B156XW02 V0 LF 220NIT 8MS 500:1	LK.15606.003
<b>MAINBOARD</b> 		1	MAINBOARD JV50_PU UMA RS780MN SB700 LF W/RTC BATTERY&MODEM BOARD
<b>MEMORY</b> 	1	SODIMM 1GB DDRII667 MICRON MT8HTF12864HDY-667G1 LF	KN.1GB0G.022
	1	SODIMM 1GB DDRII667 SAMSUNG M470T2864EH3-CE6 LF	KN.1GB04.010
	1	SODIMM 1GB DDRII667 NANYA NT1GT64UH8D0FN-3C LF (0.07U)	KN.1GB0B.027
	1	SODIMM 1GB DDRII667 HYNIX HMP112S6EFR6C-Y5 LF	KN.1GB03.026
	1	SODIMM 2GB DDRII667 SAMSUNG M470T5663EH3-CE6 LF	KN.2GB0G.012
	1	SODIMM 2GB DDRII667 NANYA NT2GT64U8HD0BN-3C LF (0.07U)	KN.2GB0B.011
	1	SODIMM 2GB DDRII667 MICRON MT16HTF25664HY-667G1 LF	KN.2GB03.011
	1	SODIMM 2GB DDRII667 HYNIX HMP125S6EFR8C-Y5 LF	KN.2GB04.010



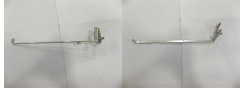
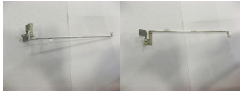
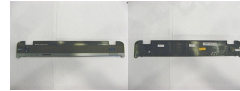

Category	No.	Part Name	Acer Part No.
<b>MISCELLANEOUS</b> 	1	LCD SCREW RUBBER	47.AU401.001
	1	NAME PLATE AS5536	40.PAW01.001
<b>MICROPHONE</b>	2	MICROPHONE	23.42239.001
	2	MICROPHONE	23.42231.001
	2	MICROPHONE	23.40544.001
	2	MICROPHONE	23.42238.001
<b>ODD</b> 	1	BLU-RAY COMBO MODULE 4X SATA	6M.PAW01.001
	2	ODD HLDS BD COMBO 12.7MM TRAY DL 4X CT10 LF W/O BEZEL SATA	KO.00405.002
	2	ODD PLDS BD COMBO 12.7MM TRAY DL 4X DS-4E1S LF W/O BEZEL SATA	KO.0040D.002
	2	ODD PIONEER BD COMBO 12.7 SATA DL 4X BDC-TD01RS LF W/O BEZEL SATA	KO.0040F.001
	1	DVD-RW SUPER-MULTI MODULE 8X SATA	6M.PAW01.002
	2	ODD PLDS SUPER-MULTI DRIVE 12.7MM TRAY DL 8X SATA DS-8A3S LF W/O BEZEL	KU.0080D.040
	2	ODD SONY SUPER-MULTI DRIVE 12.7MM TRAY DL 8X AD-7580S LF W/O BEZEL SATA	KU.0080F.004
	2	ODD TOSHIBA SUPER-MULTI DRIVE 12.7MM TRAY DL 8X SATA TS-L633B LF W/O BEZEL	KU.0080E.017
	2	ODD SONY SUPER-MULTI DRIVE 12.7MM TRAY DL 8X AD-7590S LF W/O BEZEL SATA	KU.00801.030
2	ODD HLDS SUPER-MULTI DRIVE 12.7MM TRAY DL 8X GT20N LF W/O BEZEL SATA	KU.0080E.025	
<b>SCREWS</b>	1	SCREW	86.00E12.536
	1	SCREW	86.00E34.738
	1	SCREW	86.1Z533.100
	1	SCREW	86.9A522.3R0
	1	SCREW	86.9A552.4R0
	1	SCREW	86.9A554.4R0
<b>SPEAKER</b>	2	SPEAKER ON LOWER CASE	23.40536.001
	2	SPEAKER ON LOWER CASE	23.40539.001
	2	SPEAKER ON UPPER CASE	23.40543.001
	2	SPEAKER ON UPPER CASE	23.40535.001
	2	SPEAKER ON UPPER CASE	23.40542.001

13. ACER\_ASPIRE 5536 UMACFBDBM\_JV50\_PU (NO:91.4CH01.003G)

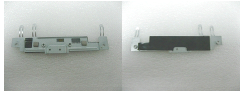
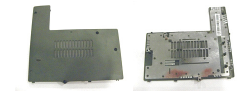



Category	No.	Part Name	Acer Part No.
<b>ADAPTER</b> 	1	ADAPTER 65W 19V 3PIN DELTA ADP-65JH DB A LV5 LED LF YELLOW	AP.06503.024
	1	ADAPTER 65W 19V 3PIN HIPRO HP-A0652R3B 1LF LV5 LED LF YELLOW	AP.06501.026
	1	ADAPTER 65W 19V 3PIN LITEON PA-1650-22AC LV5 LED LF YELLOW	AP.0650A.012
<b>BATTERY</b> 	1	BATTERY SONY AS-2007A LI-ION 3S2P SONY 6 CELL 4400MAH MAIN COMMON NORMAL TYPE	BT.00607.034
	1	BATTERY SANYO AS-2007A LI-ION 3S2P SANYO 6 CELL 4400MAH MAIN COMMON NORMAL TYPE	BT.00604.024
	1	BATTERY PANASONIC AS-2007A LI-ION 3S2P PANASONIC 6 CELL 4400MAH MAIN COMMON PSS	BT.00603.041
	1	BATTERY SIMPLO AS-2007A LI-ION 3S2P PANASONIC 6 CELL 4400MAH MAIN COMMON PSS	BT.00605.020
	1	BATTERY SIMPLO AS-2007A LI-ION 3S2P LGC 6 CELL 2150MAH 2ND COMMON	BT.00607.015
	1	BATTERY SIMPLO AS-2007A LI-ION 3S2P SAMSUNG 6 CELL 4400MAH MAIN COMMON SDI 2.2MAH F TYPE	BT.00607.019
<b>BOARDS</b> 	1	BLUETOOTH BOARD FOXCONN BCM2045 V2 T60H928.11	BT.21100.005
	1	FINGER PRINT BASE BOARD	55.PAX01.001
	1	FINGER PRINT SENSOR BOARD	55.PAX01.002
	1	LED BUTTON BOARD	55.PAW01.001
	1	MINI WLAN/B FOXCONN 802.11BGN Atheros XB63 BG T60H976.00 FW:V06 MINICARD	NI.23600.007
	2	MODEM BOARD LITEON CONEXANT -UNIZION 1.5_3.3V AUS B85247600G	FX.22500.021
	1	TOUCHPAD BOARD ALPS KGDF0038A	56.17024.051
	1	TOUCHPAD BOARD SYNAPTICS TM00540-005	56.17010.181

Category	No.	Part Name	Acer Part No.
<b>BOARDS</b> 	1	USB BOARD	55.PAW01.002
	1	WIRELESS LAN BOARD 802.11BGN FOXCONN T77H053.00 ATHEROS AR5B91 1X2	NI.23600.030
	1	WIRELESS LAN BOARD 802.11BGN QMI EM303-AR Atheros AR5B91 1X2 MINICARD	NI.23600.033
<b>CABLES</b> 	1	BLUETOOTH BOARD CABLE	50.4CG06.001
	1	BLUETOOTH BOARD CABLE	50.4CG06.011
	1	BLUETOOTH BOARD CABLE	50.4CG06.021
	1	FINGER PRINT / TP BUTTON BAORD CABLE	50.4CG01.001
	1	FINGER PRINT / TP BUTTON BAORD CABLE	50.4CG01.011
	2	LED BUTTON BOARD CABLE	50.4CG02.011
	2	LED LCD/CAMERA CABLE	50.4CG14.001
	2	LED LCD/CAMERA CABLE	50.4CG14.021
	2	LED LCD/CAMERA CABLE	50.4CG14.031
	2	MODEM CABLE	50.4CG04.001
	2	MODEM CABLE	50.4CG04.011
	1	POWER CORD 2.5A 125V USA	27.01518.A11
	1	POWER CORD 2.5A 125V 1.8M BLACK TAIWANESE	27.01518.781
	1	POWER CORD 10A 250V SWISS	27.01518.691
	1	POWER CORD 10A 250V 3PIN SWISS BK	27.01518.581
	1	POWER CORD 10A 250V ARGENTINE	27.01518.0U1
	1	POWER CORD 10A 125V US	27.01518.641
	1	POWER CORD 10A 125V 3PIN US BK	27.01518.521
	1	POWER CORD 7A 250V 2PIN KOREAN	27.01518.531
	1	POWER CORD 3A 250V 3PIN UK	27.03118.001
	1	POWER CORD 5A 250V 3PIN UK BK	27.01518.541
	1	POWER CORD 7A 125V 2PIN JAPAN	27.01518.551
	1	POWER CORD 10A 3PIN BK DENMARK	27.01518.671
	1	POWER CORD 10A 250V 3PIN DENMARK BK	27.01518.561
	1	POWER CORD 10A 250V 3PIN BK SOUTH AFRICA	27.01518.681
	1	POWER CORD 16A 250V SOUTH AFRICA BK	27.01518.571
	1	POWER CORD 10A 250V 3PIN CHINA	27.01518.701
	1	POWER CORD 10A 250V 3PIN CHINA BK	27.01518.591
	1	POWER CORD 250V 3PIN EUR BK	27.01518.731
	1	POWER CABLE 16A 250V 3PIN EUR BK	27.01518.601
	1	POWER CORD 10A 250V 3PIN ITALY	27.01518.711
	1	POWER CORD 10A 250V 3PIN ITALY BK	27.01518.611
	1	POWER CORD 2.5A 250V AUSTRALIA	27.01518.621
	1	POWER CORD 2.5A 250V SOUTH AFRICA BK (INDIA)	27.01518.721
	1	POWER CORD 10A 250V SOUTH AFRICA BK (INDIA)	27.01518.631
	1	POWER CORD 7A 125V 2PIN JAPAN BK	27.01518.661
	1	POWER CORD 250V 10A 3PIN ISRAEL	27.01518.761
	1	POWER CORD 10A 250V 1.8M BRAZIL BLK	27.01518.A41
1	POWER CORD ACA / ACNZ	27.03218.051	
1	POWER CORD 7.5A 250V 3P AUSTRALIA BK	27.03218.021	

Category	No.	Part Name	Acer Part No.	
CABLES	1	POWER CODE 7A 125V 2PIN JAPAN	27.03518.161	
	1	TOUCHPAD CABLE	50.4CG03.011	
	1	TOUCHPAD CABLE	50.4CG03.001	
	1	USB BOARD CABLE	50.4CG05.021	
	1	USB BOARD CABLE	50.4CG05.001	
	1	USB BOARD CABLE	50.4CG05.011	
CAMERA	2	CAMERA 0.3M SUYIN CN0314-SN30-OV03-5	56.18007.094	
	2	CAMERA 0.3M CHICONY CNF701721004973L	56.18012.094	
CASE/COVER/BRACKET ASSEMBLY 	2	BLUE-RAY COMBO BEZEL	42.PAW01.005	
	2	DVD-RW SUPER-MULTI BEZEL	42.PAW01.004	
	2	HDD BRACKET	33.PAW01.003	
		2	LED LCD BRACKET RIGHT W/HINGE	34.4CG12.001
		2	LED LCD BRACKET RIGHT W/HINGE	34.4CG12.011
		2	LED LCD BRACKET RIGHT W/HINGE	34.4CG12.021
		2	LED LCD BRACKET LEFT W/HINGE	34.4CG13.001
		2	LED LCD BRACKET LEFT W/HINGE	34.4CG13.011
		2	LED LCD BRACKET LEFT W/HINGE	34.4CG13.021
	2	LED LCD COVER IMR 15.6" W/ANTENNA*2 & LOGO NONE 3G	60.PAW01.005	
	2	LCD BEZEL 15.6" W/CAMERA HOLE	60.PAW01.004	
	2	LED LCD COVER IMR 15.6" W/LOGO W/O ANTENNA&3G	60.PAW01.006	
	2	LCD BEZEL 15.6" W/CAMERA HOLE	60.PAW01.004	
	1	LOWER CASE W/MODEM CABLE&SPEAKER	60.PAW01.001	
		1	MIDDLE COVER W/BLUETOOTH BUTTON WITH BLUE LIGHT NONE 3G BUTTON	42.PAW01.001
2		OPTICAL BRACKET	33.PAW01.002	
	1	SD DUMMY CARD	42.TKJ01.001	
	1	TOUCHPAD BRACKET	33.PAW01.001	
	1	UNITLOAD COVER	42.PAW01.002	
	1	UPPER CASE W/LED BUTTON BOARD CABLE&MICROPHONE&SPEAKER&FINGER PRINT HOLE	60.PAX01.001	

Category	No.	Part Name	Acer Part No.
<b>CASE/COVER/BRACKET ASSEMBLY</b> 	1	WIRELESS LAN COVER	42.PAW01.003
<b>CPU/PROCESSOR</b> 	1	CPU AMD TURION RM72 PGA 2.1G 1M 638 35W GRIFFIN B1	KC.TRM02.720
	1	CPU AMD TURION RM-74 2.2G 1M 638 35W GRIFFIN B1	KC.TRM02.740
	1	CPU AMD TURION RM75 PGA 2.2G 1M 638 35W GRIFFIN B1	KC.TRM02.750
	1	CPU AMD ATHLON64X2 QL62 PGA 2.0G 1M 638 35W GRIFFIN B1	KC.AQL02.620
	1	CPU AMD ATHLON64X2 QL-64 2.1G 638 35W GRIFFIN B1	KC.AQL02.640
	1	CPU AMD ATHLON QL65 PGA 2.1G 1M 638 35W GRIFFIN B1	KC.AQL02.650
<b>HDD/HARD DISK DRIVE</b> 	1	HDD MODULE 160GB 5400RPM SATA	
	2	HDD 160GB 5400RPM SATA WD WD1600BEVT-22ZCT0 F/W:11.01A11	KH.16007.019
	2	HDD 160GB 5400RPM SATA SEAGATE ST9160310AS F/W:2010	KH.16008.022
	2	HDD 160GB 5400RPM SATA TOSHIBA LIBRA-BS MK1655GSX F/W:FG0101J 5.4	KH.16001.034
	2	HDD 160GB 5400RPM SATA HGST HTS543216L9A300 F/W:C30C	KH.16004.006
	1	HDD MODULE 250GB 5400RPM SATA	
	2	HDD 250GB 5400RPM SATA HGST HTS545025B9A300 PANTHER-B LF F/W:C50K	KH.25008.021
	2	HDD 250GB 5400RPM SATA SEAGATE ST9250315AS LF F/W:0001SDM1	KH.25007.015
	2	HDD 250GB 5400RPM SATA TOSHIBA LIBRA-BS MK2555GSX F/W:FG000J 5.4K	KH.25001.016
	2	HDD 250GB 5400RPM SATA WD WD2500BEVT-22ZCT0 F/W:11.01A11	KH.25004.003
	1	HDD MODULE 320GB 5400RPM SATA	
	2	HDD 320GB 5400RPM SATA HGST HTS545032B9A300 PANTHER B LF	KH.32008.013
	2	HDD 320GB 5400RPM SATA SEAGATE ST9320320AS F/W:2010	KH.32007.007
	2	HDD 320GB 5400RPM SATA TOSHIBA MK3255GSX LIBRA LF F/W:FG010J	KH.32001.008
	2	HDD 320GB 5400RPM SATA WD WD3200BEVT-22ZCT0 ML125 F/W:01.01A01	KH.32004.002
	1	HDD MODULE 500GB 5400RPM SATA	
	2	HDD 500GB 5400RPM HGST SATA HTS545050B9A300 PANTHER B LF	KH.50008.013
	2	HDD SEAGATE 2.5" 5400RPM 500GB ST9500325AS SATA LF F/W:0001SDM1	KH.50007.009
	2	HDD 500GB 5400RPM SATA TOSHIBA MK5055GSX LIBRA-BS F/W:FG000J LF	KH.50001.011
	2	HDD WD 2.5" 500GB 5400RPM SATA WD5000BEVT-22ZAT0 F/W:01.01A01	KH.50004.001
<b>HEATSINK</b> 	1	CPU HEATSINK UMA W/FAN	60.4CH17.001
	1	CPU HEATSINK UMA W/FAN	60.4CH11.001
	1	CPU HEATSINK UMA W/FAN	60.4CH04.001
<b>KEYBOARD</b> 	1	KEYBOARD 104KEYS NSK-ALA0J AC7T JV50 INTERNAL 17 STANDARD BLACK TEXTURE UK	KB.1170A.055

Category	No.	Part Name	Acer Part No.
KEYBOARD	1	KEYBOARD 103KEYS NSK-ALA0J AC7T JV50 INTERNAL 17 STANDARD BLACK TEXTURE US-INTERNATIONAL	KB.1170A.056
	1	KEYBOARD 107KEYS NSK-ALA0J AC7T JV50 INTERNAL 17 STANDARD BLACK TEXTURE JAPANESE	KB.1170A.044
	1	KEYBOARD 103KEYS NSK-ALA0J AC7T JV50 INTERNAL 17 STANDARD BLACK TEXTURE GREEK	KB.1170A.041
	1	KEYBOARD 103KEYS NSK-ALA0J AC7T JV50 INTERNAL 17 STANDARD BLACK TEXTURE TAIWAN	KB.1170A.036
	1	KEYBOARD 103KEYS NSK-ALA0J AC7T JV50 INTERNAL 17 STANDARD BLACK TEXTURE THAILAND	KB.1170A.053
	1	KEYBOARD 103KEYS NSK-ALA0J AC7T JV50 INTERNAL 17 STANDARD BLACK TEXTURE HEBREW	KB.1170A.057
	1	KEYBOARD 103KEYS NSK-ALA0J AC7T JV50 INTERNAL 17 STANDARD BLACK TEXTURE ARABIC	KB.1170A.032
	1	KEYBOARD 103KEYS NSK-ALA0J AC7T JV50 INTERNAL 17 STANDARD BLACK TEXTURE RUSSIAN	KB.1170A.048
	1	KEYBOARD 103KEYS NSK-ALA0J AC7T JV50 INTERNAL 17 STANDARD BLACK TEXTURE KOREA	TBD
	1	KEYBOARD 103KEYS NSK-ALA0J AC7T JV50 INTERNAL 17 STANDARD BLACK TEXTURE BLANK	TBD
	1	KEYBOARD 104KEYS NSK-ALA0J AC7T JV50 INTERNAL 17 STANDARD BLACK TEXTURE SWEDISH	KB.1170A.051
	1	KEYBOARD 104KEYS NSK-ALA0J AC7T JV50 INTERNAL 17 STANDARD BLACK TEXTURE FRENCH	KB.1170A.039
	1	KEYBOARD 104KEYS NSK-ALA0J AC7T JV50 INTERNAL 17 STANDARD BLACK TEXTURE PORTUGAL	KB.1170A.047
	1	KEYBOARD 104KEYS NSK-ALA0J AC7T JV50 INTERNAL 17 STANDARD BLACK TEXTURE SLOVE	KB.1170A.049
	1	KEYBOARD 104KEYS NSK-ALA0J AC7T JV50 INTERNAL 17 STANDARD BLACK TEXTURE BRAZILIAN PORTUGUESE	KB.1170A.034
	1	KEYBOARD 104KEYS NSK-ALA0J AC7T JV50 INTERNAL 17 STANDARD BLACK TEXTURE SWISS	KB.1170A.052
	1	KEYBOARD 104KEYS NSK-ALA0J AC7T JV50 INTERNAL 17 STANDARD BLACK TEXTURE DANISH	KB.1170A.037
	1	KEYBOARD 104KEYS NSK-ALA0J AC7T JV50 INTERNAL 17 STANDARD BLACK TEXTURE ITALIAN	KB.1170A.043
	1	KEYBOARD 104KEYS NSK-ALA0J AC7T JV50 INTERNAL 17 STANDARD BLACK TEXTURE BELGIAN	KB.1170A.033
	1	KEYBOARD 104KEYS NSK-ALA0J AC7T JV50 INTERNAL 17 STANDARD BLACK TEXTURE GERMAN	KB.1170A.040
	1	KEYBOARD 104KEYS NSK-ALA0J AC7T JV50 INTERNAL 17 STANDARD BLACK TEXTURE CZECH	TBD
	1	KEYBOARD 104KEYS NSK-ALA0J AC7T JV50 INTERNAL 17 STANDARD BLACK TEXTURE FRENCH CANADIAN	TBD
	1	KEYBOARD 104KEYS NSK-ALA0J AC7T JV50 INTERNAL 17 STANDARD BLACK TEXTURE NORWEGIAN	KB.1170A.046
	1	KEYBOARD 104KEYS NSK-ALA0J AC7T JV50 INTERNAL 17 STANDARD BLACK TEXTURE HUNGARIAN	KB.1170A.042
	1	KEYBOARD 104KEYS NSK-ALA0J AC7T JV50 INTERNAL 17 STANDARD BLACK TEXTURE SPANISH	KB.1170A.050
	1	KEYBOARD 104KEYS NSK-ALA0J AC7T JV50 INTERNAL 17 STANDARD BLACK TEXTURE TURKISH	KB.1170A.054
	1	KEYBOARD 104KEYS NSK-ALA0J AC7T JV50 INTERNAL 17 STANDARD BLACK TEXTURE NORDIC	KB.1170A.045
	1	KEYBOARD 104KEYS NSK-ALA0J AC7T JV50 INTERNAL 17 STANDARD BLACK TEXTURE FRENCH ARABIC	KB.1170A.038
	1	KEYBOARD 104KEYS NSK-ALA0J AC7T JV50 INTERNAL 17 STANDARD BLACK TEXTURE FRENCH CANADIAN	KB.1170A.058
	1	KEYBOARD 104KEYS NSK-ALA0J AC7T JV50 INTERNAL 17 STANDARD BLACK TEXTURE CZECH/SLOVAK	KB.1170A.035
	1	KEYBOARD 104KEYS NSK-ALA0J AC7T JV50 INTERNAL 17 STANDARD BLACK TEXTURE SLOVAK	TBD

Category	No.	Part Name	Acer Part No.
<b>KEYBOARD</b>	1	KEYBOARD 104KEYS NSK-ALA0J AC7T JV50 INTERNAL 17 STANDARD BLACK TEXTURE BLANK	TBD
<b>LCD</b> 	1	LED LCD MODULE 15.6" WXGA GLARE W/ ANTENNA*2&CAMERA (NONE 3G)	6M.PAW01.003
	2	LED LCD 15.6" WXGA GLARE AUO B156XW02 V0 LF 220NIT 8MS 500:1	LK.15608.002
	2	LED LCD 15.6" WXGA GLARE CMO N156B6-L04 LF 220NIT 8MS 500:1	LK.15605.003
	2	LED LCD 15.6" WXGA GLARE SAMSUNG LTN156AT02-A01 LF 220NIT 8MS 500:1	LK.1560D.005
	2	LED LCD 15.6" WXGA GLARE LG LP156WH2-TLE1 LF 220NIT 8MS 400:1	LK.15606.003
	1	LED LCD MODULE 15.6" WXGA GLARE W/CAMERA W/O ANTENNA (NONE 3G)	6M.PAW01.004
<b>MICROPHONE</b>	2	MICROPHONE	23.42239.001
	2	MICROPHONE	23.42231.001
	2	MICROPHONE	23.40544.001
	2	MICROPHONE	23.42238.001
<b>ODD</b> 	1	BLU-RAY COMBO MODULE 4X SATA	6M.PAW01.001
	2	ODD HLDS BD COMBO 12.7MM TRAY DL 4X CT10 LF W/O BEZEL SATA	KO.00405.002
	2	ODD PLDS BD COMBO 12.7MM TRAY DL 4X DS-4E1S LF W/O BEZEL SATA	KO.0040D.002
	2	ODD PIONEER BD COMBO 12.7 SATA DL 4X BDC-TD01RS LF W/O BEZEL SATA	KO.0040F.001
	1	DVD-RW SUPER-MULTI MODULE 8X SATA	6M.PAW01.002
	2	ODD SONY SUPER-MULTI DRIVE 12.7MM TRAY DL 8X AD-7580S LF W/O BEZEL SATA	KU.0080F.004
	2	ODD TOSHIBA SUPER-MULTI DRIVE 12.7MM TRAY DL 8X SATA TS-L633B LF W/O BEZEL	KU.0080E.017
	2	ODD SONY SUPER-MULTI DRIVE 12.7MM TRAY DL 8X AD-7590S LF W/O BEZEL SATA	KU.00801.030
	2	ODD HLDS SUPER-MULTI DRIVE 12.7MM TRAY DL 8X GT20N LF W/O BEZEL SATA	KU.0080E.025
	2	ODD PLDS SUPER-MULTI DRIVE 12.7MM TRAY DL 8X SATA DS-8A3S LF W/O BEZEL	KU.0080D.040
<b>MAINBOARD</b> 	1	MAINBOARD JV50_PU UMA RS780MN SB700 LF W/RTC BATTERY&MODEM BOARD	MB.P4201.001
<b>MEMORY</b> 	1	SODIMM 1GB DDRII667 SAMSUNG M470T2864EH3-CE6 LF	KN.1GB0G.022
	1	SODIMM 1GB DDRII667 NANYA NT1GT64UH8D0FN-3C LF (0.07U)	KN.1GB0B.027
	1	SODIMM 1GB DDRII667 MICRON MT8HTF12864HDY-667G1 LF	KN.1GB03.026
	1	SODIMM 1GB DDRII667 HYNIX HMP112S6EFR6C-Y5 LF	KN.1GB04.010
	1	SODIMM 2GB DDRII667 SAMSUNG M470T5663EH3-CE6 LF	KN.2GB0G.012
	1	SODIMM 2GB DDRII667 NANYA NT2GT64U8HD0BN-3C LF (0.07U)	KN.2GB0B.011
	1	SODIMM 2GB DDRII667 MICRON MT16HTF25664HY-667G1 LF	KN.2GB03.011
	1	SODIMM 2GB DDRII667 HYNIX HMP125S6EFR8C-Y5 LF	KN.2GB04.010
<b>MISCELLANEOUS</b>	1	LCD SCREW RUBBER	47.AU401.001
	1	NAME PLATE AS5536	40.PAW01.001





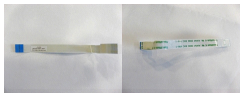
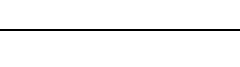

Category	No.	Part Name	Acer Part No.
<b>SCREWS</b>	1	SCREW	86.00E12.536
	1	SCREW	86.00E34.738
	1	SCREW	86.1Z533.100
	1	SCREW	86.9A522.3R0
	1	SCREW	86.9A552.4R0
	1	SCREW	86.9A554.4R0
<b>SPEAKER</b>	2	SPEAKER ON LOWER CASE	23.40536.001
	2	SPEAKER ON LOWER CASE	23.40539.001
	2	SPEAKER ON UPPER CASE	23.40543.001
	2	SPEAKER ON UPPER CASE	23.40535.001
	2	SPEAKER ON UPPER CASE	23.40542.001

14. ACER\_ASPIRE 5536G M92XT512CBDBM\_JV50\_PU (NO:91.4CH01.002G)

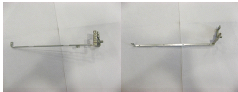
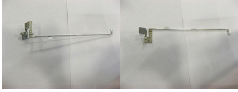
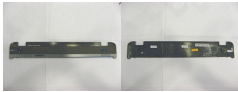

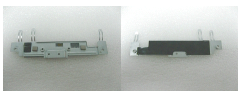
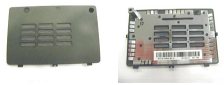

Category	No.	Part Name	Acer Part No.
<b>ADAPTER</b> 	1	ADPAPTER 90W 19V 3PIN LITEON PA-1900-34AR LV5 LED LF BLUE	AP.0900A.005
	1	ADAPTER 90W 19V 3PIN DELTA ADP-90CD DB A LV5 LED LF BLUE	AP.09003.021
	1	ADPAPTER 90W 19V 3PIN HIPRO HP-A0904A3 B1LF LV5 LED LF BLUE	AP.09001.027
<b>BATTERY</b> 	1	BATTERY SIMPLO AS-2007A LI-ION 3S2P PANASONIC 6 CELL 4400MAH MAIN COMMON PSS	BT.00607.034
	1	BATTERY SANYO AS-2007A LI-ION 3S2P SANYO 6 CELL 4400MAH MAIN COMMON NORMAL TYPE	BT.00607.015
	1	BATTERY SONY AS-2007A LI-ION 3S2P SONY 6 CELL 4400MAH MAIN COMMON NORMAL TYPE	BT.00603.041
	1	BATTERY PANASONIC AS-2007A LI-ION 3S2P PANASONIC 6 CELL 4400MAH MAIN COMMON PSS	BT.00604.024
	1	BATTERY SIMPLO AS-2007A LI-ION 3S2P LGC 6 CELL 2150MAH 2ND COMMON	BT.00605.020
	1	BATTERY SIMPLO AS-2007A LI-ION 3S2P SAMSUNG 6 CELL 4400MAH MAIN COMMON SDI 2.2MAH F TYPE	BT.00607.019
<b>BOARDS</b> 	1	MINI WLAN/B FOXCONN 802.11BGN ATHEROS XB63 BG T60H976.00 FW:V06 MINICARD	NI.23600.007
	1	BLUETOOTH BOARD FOXCONN BCM2045 V2 T60H928.11	BT.21100.005
	1	LED BUTTON BOARD	55.PAW01.001
	2	MODEM BOARD LITEON CONEXANT -UNIZION 1.5_3.3V AUS B85247600G	FX.22500.021
	1	TOUCHPAD BOARD SYNAPTICS TM00540-005	56.17010.181
	1	TOUCHPAD BOARD ALPS KGDF0038A	56.17024.051

Category	No.	Part Name	Acer Part No.	
<b>BOARDS</b>	1	TOUCH PAD BUTTON BOARD	55.PAW01.003	
		1	USB BOARD	55.PAW01.002
		1	WIRELESS LAN BOARD 802.11BGN FOXCONN T77H053.00 ATHEROS AR5B91 1X2	NI.23600.030
	1	WIRELESS LAN BOARD 802.11BGN QMI EM303-AR Atheros AR5B91 1X2 MINICARD	NI.23600.033	
<b>CABLES</b>	1	BLUETOOTH BOARD CABLE	50.4CG06.021	
	1	BLUETOOTH BOARD CABLE	50.4CG06.001	
	1	BLUETOOTH BOARD CABLE	50.4CG06.011	
	1	FINGER PRINT / TP BUTTON BOARD CABLE	50.4CG01.001	
	1	FINGER PRINT / TP BUTTON BOARD CABLE	50.4CG01.011	
	2	LED BUTTON BOARD CABLE	50.4CG02.001	
	2	LED BUTTON BOARD CABLE	50.4CG02.011	
	2	LED LCD/CAMERA CABLE	50.4CG14.031	
	2	LED LCD/CAMERA CABLE	50.4CG14.001	
	2	LED LCD/CAMERA CABLE	50.4CG14.021	
	2	MODEM CABLE	50.4CG04.001	
	2	MODEM CABLE	50.4CG04.011	
	1	POWER CORD 2.5A 125V USA	27.01518.A11	
	1	POWER CORD 2.5A 125V 1.8M BLACK TAIWANESE	27.01518.781	
	1	POWER CORD 10A 250V SWISS	27.01518.691	
	1	POWER CORD 10A 250V 3PIN SWISS BK	27.01518.581	
	1	POWER CORD 10A 250V ARGENTINE	27.01518.0U1	
	1	POWER CORD 10A 125V US	27.01518.641	
	1	POWER CORD 10A 125V 3PIN US BK	27.01518.521	
	1	POWER CORD 7A 250V 2PIN KOREAN	27.01518.531	
	1	POWER CORD 3A 250V 3PIN UK	27.03118.001	
	1	POWER CORD 5A 250V 3PIN UK BK	27.01518.541	
	1	POWER CORD 7A 125V 2PIN JAPAN	27.01518.551	
	1	POWER CORD 10A 3PIN BK DENMARK	27.01518.671	
	1	POWER CORD 10A 250V 3PIN DENMARK BK	27.01518.561	
	1	POWER CORD 10A 250V 3PIN BK SOUTH AFRICA	27.01518.681	
	1	POWER CORD 16A 250V SOUTH AFRICA BK	27.01518.571	
	1	POWER CORD 10A 250V 3PIN CHINA	27.01518.701	
	1	POWER CORD 10A 250V 3PIN CHINA BK	27.01518.591	
	1	POWER CORD 250V 3PIN EUR BK	27.01518.731	
	1	POWER CABLE 16A 250V 3PIN EUR BK	27.01518.601	
	1	POWER CORD 10A 250V 3PIN ITALY	27.01518.711	
	1	POWER CORD 10A 250V 3PIN ITALY BK	27.01518.611	
	1	POWER CORD 2.5A 250V AUSTRALIA	27.01518.621	
	1	POWER CORD 2.5A 250V SOUTH AFRICA BK (INDIA)	27.01518.721	
	1	POWER CORD 10A 250V SOUTH AFRICA BK (INDIA)	27.01518.631	
1	POWER CORD 7A 125V 2PIN JAPAN BK	27.01518.661		
1	POWER CORD 250V 10A 3PIN ISRAEL	27.01518.761		

Category	No.	Part Name	Acer Part No.	
<b>CABLES</b>	1	POWER CORD 10A 250V 1.8M BRAZIL BLK	27.01518.A41	
	1	POWER CORD ACA / ACNZ	27.03218.051	
	1	POWER CORD 7.5A 250V 3P AUSTRALIA BK	27.03218.021	
	1	POWER CODE 7A 125V 2PIN JAPAN	27.03518.161	
	1	USB BOARD CABLE	50.4CG05.021	
	1	USB BOARD CABLE	50.4CG05.001	
	1	USB BOARD CABLE	50.4CG05.011	
	1	TOUCHPAD CABLE	50.4CG03.011	
	1	TOUCHPAD CABLE	50.4CG03.001	
<b>CAMERA</b>	2	CAMERA 0.3M CHICONY CNF701721004973L	56.18012.094	
	2	CAMERA 0.3M SUYIN CN0314-SN30-OV03-5	56.18007.094	
<b>CASE/COVER/BRACKET ASSEMBLY</b> 	2	BLUE-RAY COMBO BEZEL	42.PAW01.005	
	2	DVD-RW SUPER-MULTI BEZEL	42.PAW01.004	
	2	HDD BRACKET	33.PAW01.003	
	2	LCD BEZEL 15.6" W/CAMERA HOLE	60.PAW01.004	
		2	LED LCD BRACKET RIGHT W/HINGE	34.4CG12.001
		2	LED LCD BRACKET RIGHT W/HINGE	34.4CG12.011
		2	LED LCD BRACKET RIGHT W/HINGE	34.4CG12.021
		2	LED LCD BRACKET LEFT W/HINGE	34.4CG13.001
		2	LED LCD BRACKET LEFT W/HINGE	34.4CG13.011
		2	LED LCD BRACKET LEFT W/HINGE	34.4CG13.021
		2	LED LCD COVER IMR 15.6" W/ANTENNA*2 & LOGO NONE 3G	60.PAW01.005
		2	LED LCD COVER IMR 15.6" W/LOGO W/O ANTENNA&3G	60.PAW01.006
		1	LOWER CASE W/MODEM CABLE&SPEAKER	60.PAW01.001
		1	MIDDLE COVER W/BLUETOOTH BUTTON WITH BLUE LIGHT NONE 3G BUTTON	42.PAW01.001
		2	OPTICAL BRACKET	33.PAW01.002
	1	SD DUMMY CARD	42.TKJ01.001	
	1	TOUCHPAD BRACKET	33.PAW01.001	
	1	WIRELESS LAN COVER	42.PAW01.003	

Category	No.	Part Name	Acer Part No.
<b>CASE/COVER/BRACKET ASSEMBLY</b> 	1	UNITLOAD COVER	42.PAW01.002
	1	UPPER CASE W/LED BUTTON BOARD CABLE&MICROPHONE&SPEAKER W/O FINGER PRINT HOLE	60.PAW01.002
<b>CPU/PROCESSOR</b> 	1	CPU AMD ATHLON64X2 QL-64 2.1G 638 35W GRIFFIN B1	KC.AQL02.640
	1	CPU AMD ATHLON64X2 QL62 PGA 2.0G 1M 638 35W GRIFFIN B1	KC.AQL02.620
	1	CPU AMD ATHLON QL65 PGA 2.1G 1M 638 35W GRIFFIN B1	KC.AQL02.650
	1	CPU AMD TURION RM-74 2.2G 1M 638 35W GRIFFIN B1	KC.TRM02.740
	1	CPU AMD TURION RM72 PGA 2.1G 1M 638 35W GRIFFIN B1	KC.TRM02.720
	1	CPU AMD TURION RM75 PGA 2.2G 1M 638 35W GRIFFIN B1	KC.TRM02.750
<b>HDD/HARD DISK DRIVE</b> 	1	HDD MODULE 160GB 5400RPM SATA	
	2	HDD 160GB 5400RPM SATA WD WD1600BEVT-22ZCT0 F/W:11.01A11	KH.16007.019
	2	HDD 160GB 5400RPM SATA SEAGATE ST9160310AS F/W:2010	KH.16008.022
	2	HDD 160GB 5400RPM SATA TOSHIBA LIBRA-BS MK1655GSX F/W:FG0101J 5.4	KH.16001.034
	2	HDD 160GB 5400RPM SATA HGST HTS543216L9A300 F/W:C30C	KH.16004.006
	1	HDD MODULE 250GB 5400RPM SATA	
	2	HDD 250GB 5400RPM SATA HGST HTS545025B9A300 PANTHER-B LF F/W:C50K	KH.25008.021
	2	HDD 250GB 5400RPM SATA SEAGATE ST9250315AS LF F/W:0001SDM1	KH.25007.015
	2	HDD 250GB 5400RPM SATA TOSHIBA LIBRA-BS MK2555GSX F/W:FG000J 5.4K	KH.25001.016
	2	HDD 250GB 5400RPM SATA WD WD2500BEVT-22ZCT0 F/W:11.01A11	KH.25004.003
	1	HDD MODULE 320GB 5400RPM SATA	
	2	HDD 320GB 5400RPM SATA WD WD3200BEVT-22ZCT0 ML125 F/W:01.01A01	KH.32004.002
	2	HDD 320GB 5400RPM SATA HGST HTS545032B9A300 PANTHER B LF	KH.32008.013
	2	HDD 320GB 5400RPM SATA SEAGATE ST9320320AS F/W:2010	KH.32007.007
	2	HDD 320GB 5400RPM SATA TOSHIBA MK3255GSX LIBRA LF F/W:FG010J	KH.32001.008
	1	HDD MODULE 500GB 5400RPM SATA	
	2	HDD 500GB 5400RPM HGST SATA HTS545050B9A300 PANTHER B LF	KH.50008.013
	2	HDD SEAGATE 2.5" 5400RPM 500GB ST9500325AS SATA LF F/W:0001SDM1	KH.50007.009
	2	HDD 500GB 5400RPM SATA TOSHIBA MK5055GSX LIBRA-BS F/W:FG000J LF	KH.50001.011
	2	HDD WD 2.5" 500GB 5400RPM SATA WD5000BEVT-22ZAT0 F/W:01.01A01	KH.50004.001
<b>HEATSINK</b> 	1	CPU HEATSINK DISCRETE W/FAN	60.4CH13.001
	1	CPU HEATSINK DISCRETE W/FAN	60.4CH07.001
	1	CPU HEATSINK DISCRETE W/FAN	60.4CH02.001

Category	No.	Part Name	Acer Part No.
<b>KEYBOARD</b> 	1	KEYBOARD 103KEYS NSK-ALA0J AC7T JV50 INTERNAL 17 STANDARD BLACK TEXTURE US-INTERNATIONAL	KB.I170A.056
	1	KEYBOARD 104KEYS NSK-ALA0J AC7T JV50 INTERNAL 17 STANDARD BLACK TEXTURE UK	KB.I170A.055
	1	KEYBOARD 107KEYS NSK-ALA0J AC7T JV50 INTERNAL 17 STANDARD BLACK TEXTURE JAPANESE	KB.I170A.044
	1	KEYBOARD 103KEYS NSK-ALA0J AC7T JV50 INTERNAL 17 STANDARD BLACK TEXTURE GREEK	KB.I170A.041
	1	KEYBOARD 103KEYS NSK-ALA0J AC7T JV50 INTERNAL 17 STANDARD BLACK TEXTURE TAIWAN	KB.I170A.036
	1	KEYBOARD 103KEYS NSK-ALA0J AC7T JV50 INTERNAL 17 STANDARD BLACK TEXTURE THAILAND	KB.I170A.053
	1	KEYBOARD 103KEYS NSK-ALA0J AC7T JV50 INTERNAL 17 STANDARD BLACK TEXTURE HEBREW	KB.I170A.057
	1	KEYBOARD 103KEYS NSK-ALA0J AC7T JV50 INTERNAL 17 STANDARD BLACK TEXTURE ARABIC	KB.I170A.032
	1	KEYBOARD 103KEYS NSK-ALA0J AC7T JV50 INTERNAL 17 STANDARD BLACK TEXTURE RUSSIAN	KB.I170A.048
	1	KEYBOARD 103KEYS NSK-ALA0J AC7T JV50 INTERNAL 17 STANDARD BLACK TEXTURE KOREA	TBD
	1	KEYBOARD 103KEYS NSK-ALA0J AC7T JV50 INTERNAL 17 STANDARD BLACK TEXTURE BLANK	TBD
	1	KEYBOARD 104KEYS NSK-ALA0J AC7T JV50 INTERNAL 17 STANDARD BLACK TEXTURE SWEDISH	KB.I170A.051
	1	KEYBOARD 104KEYS NSK-ALA0J AC7T JV50 INTERNAL 17 STANDARD BLACK TEXTURE FRENCH	KB.I170A.039
	1	KEYBOARD 104KEYS NSK-ALA0J AC7T JV50 INTERNAL 17 STANDARD BLACK TEXTURE PORTUGAL	KB.I170A.047
	1	KEYBOARD 104KEYS NSK-ALA0J AC7T JV50 INTERNAL 17 STANDARD BLACK TEXTURE SLOVE	KB.I170A.049
	1	KEYBOARD 104KEYS NSK-ALA0J AC7T JV50 INTERNAL 17 STANDARD BLACK TEXTURE BRAZILIAN PORTUGUESE	KB.I170A.034
	1	KEYBOARD 104KEYS NSK-ALA0J AC7T JV50 INTERNAL 17 STANDARD BLACK TEXTURE SWISS	KB.I170A.052
	1	KEYBOARD 104KEYS NSK-ALA0J AC7T JV50 INTERNAL 17 STANDARD BLACK TEXTURE DANISH	KB.I170A.037
	1	KEYBOARD 104KEYS NSK-ALA0J AC7T JV50 INTERNAL 17 STANDARD BLACK TEXTURE ITALIAN	KB.I170A.043
	1	KEYBOARD 104KEYS NSK-ALA0J AC7T JV50 INTERNAL 17 STANDARD BLACK TEXTURE BELGIAN	KB.I170A.033
	1	KEYBOARD 104KEYS NSK-ALA0J AC7T JV50 INTERNAL 17 STANDARD BLACK TEXTURE GERMAN	KB.I170A.040
	1	KEYBOARD 104KEYS NSK-ALA0J AC7T JV50 INTERNAL 17 STANDARD BLACK TEXTURE CZECH	TBD
	1	KEYBOARD 104KEYS NSK-ALA0J AC7T JV50 INTERNAL 17 STANDARD BLACK TEXTURE FRENCH CANADIAN	TBD
	1	KEYBOARD 104KEYS NSK-ALA0J AC7T JV50 INTERNAL 17 STANDARD BLACK TEXTURE NORWEGIAN	KB.I170A.046
	1	KEYBOARD 104KEYS NSK-ALA0J AC7T JV50 INTERNAL 17 STANDARD BLACK TEXTURE HUNGARIAN	KB.I170A.042
	1	KEYBOARD 104KEYS NSK-ALA0J AC7T JV50 INTERNAL 17 STANDARD BLACK TEXTURE SPANISH	KB.I170A.050
	1	KEYBOARD 104KEYS NSK-ALA0J AC7T JV50 INTERNAL 17 STANDARD BLACK TEXTURE TURKISH	KB.I170A.054
	1	KEYBOARD 104KEYS NSK-ALA0J AC7T JV50 INTERNAL 17 STANDARD BLACK TEXTURE NORDIC	KB.I170A.045
	1	KEYBOARD 104KEYS NSK-ALA0J AC7T JV50 INTERNAL 17 STANDARD BLACK TEXTURE FRENCH ARABIC	KB.I170A.038
	1	KEYBOARD 104KEYS NSK-ALA0J AC7T JV50 INTERNAL 17 STANDARD BLACK TEXTURE FRENCH CANADIAN	KB.I170A.058
1	KEYBOARD 104KEYS NSK-ALA0J AC7T JV50 INTERNAL 17 STANDARD BLACK TEXTURE CZECH/SLOVAK	KB.I170A.035	

Category	No.	Part Name	Acer Part No.
<b>KEYBOARD</b>	1	KEYBOARD 104KEYS NSK-ALA0J AC7T JV50 INTERNAL 17 STANDARD BLACK TEXTURE SLOVAK	TBD
	1	KEYBOARD 104KEYS NSK-ALA0J AC7T JV50 INTERNAL 17 STANDARD BLACK TEXTURE BLANK	TBD
<b>LCD</b> 	1	LED LCD MODULE 15.6" WXGA GLARE W/ ANTENNA*2&CAMERA (NONE 3G)	6M.PAW01.003
	2	LED LCD 15.6" WXGA GLARE SAMSUNG LTN156AT02-A01 LF 220NIT 8MS 500:1	LK.1560D.005
	2	LED LCD 15.6" WXGA GLARE CMO N156B6-L04 LF 220NIT 8MS 500:1	LK.15608.002
	2	LED LCD 15.6" WXGA GLARE AUO B156XW02 V0 LF 220NIT 8MS 500:1	LK.15606.003
	2	LED LCD 15.6" WXGA GLARE LG LP156WH2-TLE1 LF 220NIT 8MS 400:1	LK.15605.003
	1	LED LCD MODULE 15.6" WXGA GLARE W/CAMERA W/O ANTENNA (NONE 3G)	6M.PAW01.004
	2	LED LCD 15.6" WXGA GLARE SAMSUNG LTN156AT02-A01 LF 220NIT 8MS 500:1	LK.1560D.005
	<b>MAINBOARD</b> 	1	MAINBOARD AS5536G ATI RS780 SB700 M92M-XT 512MB LF W/RTC BATTERY&MODEM BOARD
<b>MEMORY</b> 	1	SODIMM 1GB DDRII667 NANYA NT1GT64UH8D0FN-3C LF (0.07U)	KN.1GB0G.022
	1	SODIMM 1GB DDRII667 MICRON MT8HTF12864HDY-667G1 LF	KN.1GB03.026
	1	SODIMM 1GB DDRII667 SAMSUNG M470T2864EH3-CE6 LF	KN.1GB04.010
	1	SODIMM 1GB DDRII667 HYNIX HMP112S6EFR6C-Y5 LF	KN.1GB0B.027
	1	SODIMM 2GB DDRII667 MICRON MT16HTF25664HY-667G1 LF	KN.2GB0G.012
	1	SODIMM 2GB DDRII667 SAMSUNG M470T5663EH3-CE6 LF	KN.2GB04.010
	1	SODIMM 2GB DDRII667 NANYA NT2GT64U8HD0BN-3C LF (0.07U)	KN.2GB0B.011
	1	SODIMM 2GB DDRII667 HYNIX HMP125S6EFR8C-Y5 LF	KN.2GB03.011
<b>MICROPHONE</b>	2	MICROPHONE	23.42239.001
	2	MICROPHONE	23.42231.001
	2	MICROPHONE	23.40544.001
	2	MICROPHONE	23.42238.001
<b>MISCELLANEOUS</b>	1	LCD SCREW RUBBER	47.AU401.001
	1	NAME PLATE AS5536G	40.PB101.001
<b>ODD</b> 	1	BLU-RAY COMBO MODULE 4X SATA	6M.PAW01.001
	2	OPTICAL BRACKET	33.PAW01.002
	2	ODD PLDS BD COMBO 12.7MM TRAY DL 4X DS-4E1S LF W/O BEZEL SATA	KO.00405.002
	2	ODD HLDS BD COMBO 12.7MM TRAY DL 4X CT10 LF W/O BEZEL SATA	KO.0040F.001
	2	ODD PIONEER BD COMBO 12.7 SATA DL 4X BDC-TD01RS LF W/O BEZEL SATA	KO.0040D.002
	1	DVD-RW SUPER-MULTI MODULE 8X SATA	6M.PAW01.002
	2	ODD SONY SUPER-MULTI DRIVE 12.7MM TRAY DL 8X AD-7580S LF W/O BEZEL SATA	KU.0080F.004
	2	ODD TOSHIBA SUPER-MULTI DRIVE 12.7MM TRAY DL 8X SATA TS-L633B LF W/O BEZEL	KU.0080E.017
	2	ODD SONY SUPER-MULTI DRIVE 12.7MM TRAY DL 8X AD-7590S LF W/O BEZEL SATA	KU.00801.030
	2	ODD HLDS SUPER-MULTI DRIVE 12.7MM TRAY DL 8X GT20N LF W/O BEZEL SATA	KU.0080E.025





Category	No.	Part Name	Acer Part No.
ODD	2	ODD PLDS SUPER-MULTI DRIVE 12.7MM TRAY DL 8X SATA DS-8A3S LF W/O BEZEL	KU.0080D.040
SCREWS	1	SCREW	86.00E12.536
	1	SCREW	86.00E34.738
	1	SCREW	86.1Z533.100
	1	SCREW	86.9A522.3R0
	1	SCREW	86.9A552.4R0
	1	SCREW	86.9A554.4R0
SPEAKER	2	SPEAKER ON UPPER CASE	23.40543.001
	2	SPEAKER ON UPPER CASE	23.40535.001
	2	SPEAKER ON UPPER CASE	23.40542.001
	2	SPEAKER ON LOWER CASE	23.40536.001
	2	SPEAKER ON LOWER CASE	23.40539.001

15. ACER\_ASPIRE 5536G M92XT512CFBDBM\_JV50\_PU (NO:S2.PB10X.002)

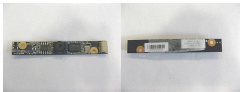

Category	No.	Part Name	Acer Part No.
 ADAPTER	1	ADAPTER 90W 19V 3PIN DELTA ADP-90CD DB A LV5 LED LF BLUE	AP.0900A.005
	1	ADPAPTER 90W 19V 3PIN LITEON PA-1900-34AR LV5 LED LF BLUE	AP.09001.027
	1	ADPAPTER 90W 19V 3PIN HIPRO HP-A0904A3 B1LF LV5 LED LF BLUE	AP.09003.021
 BATTERY	1	BATTERY SANYO AS-2007A LI-ION 3S2P SANYO 6 CELL 4400MAH MAIN COMMON NORMAL TYPE	BT.00607.034
	1	BATTERY SONY AS-2007A LI-ION 3S2P SONY 6 CELL 4400MAH MAIN COMMON NORMAL TYPE	BT.00603.041
	1	BATTERY PANASONIC AS-2007A LI-ION 3S2P PANASONIC 6 CELL 4400MAH MAIN COMMON PSS	BT.00604.024
	1	BATTERY SIMPLO AS-2007A LI-ION 3S2P PANASONIC 6 CELL 4400MAH MAIN COMMON PSS	BT.00605.020
	1	BATTERY SIMPLO AS-2007A LI-ION 3S2P LGC 6 CELL 2150MAH 2ND COMMON	BT.00607.015
	1	BATTERY SIMPLO AS-2007A LI-ION 3S2P SAMSUNG 6 CELL 4400MAH MAIN COMMON SDI 2.2MAH F TYPE	BT.00607.019
 BOARDS	1	BLUETOOTH BOARD FOXCONN BCM2045 V2 T60H928.11	BT.21100.005
	1	FINGER PRINT BASE BOARD	55.PAX01.001
	1	FINGER PRINT SENSOR BOARD	55.PAX01.002
	1	LED BUTTON BOARD	55.PAW01.001
	2	MODEM BOARD LITEON CONEXANT -UNIZION 1.5_3.3V AUS B85247600G	FX.22500.021

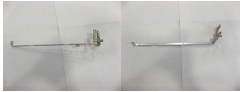
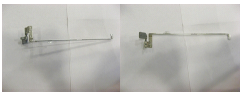

Category	No.	Part Name	Acer Part No.
<b>BOARDS</b>	1	MINI WLAN/B FOXCONN 802.11BGN ATHEROS XB63 BG T60H976.00 FW:V06 MINICARD	NI.23600.007
	1	TOUCHPAD BOARD ALPS KGDF0038A	56.17024.051
	1	TOUCHPAD BOARD SYNAPTICS TM00540-005	56.17010.181
	1	USB BOARD	55.PAW01.002
	1	WIRELESS LAN BOARD 802.11BGN FOXCONN T77H053.00 ATHEROS AR5B91 1X2	NI.23600.030
	1	WIRELESS LAN BOARD 802.11BGN QMI EM303-AR ATHEROS AR5B91 1X2 MINICARD	NI.23600.033
<b>CABLES</b>	1	BLUETOOTH BOARD CABLE	50.4CG06.021
	1	BLUETOOTH BOARD CABLE	50.4CG06.001
	1	BLUETOOTH BOARD CABLE	50.4CG06.011
	1	FINGER PRINT / TP BUTTON BOARD CABLE	50.4CG01.001
	1	FINGER PRINT / TP BUTTON BOARD CABLE	50.4CG01.011
	2	LED BUTTON BOARD CABLE	50.4CG02.011
	2	LED BUTTON BOARD CABLE	50.4CG02.001
	2	LED LCD/CAMERA CABLE	50.4CG14.001
	2	LED LCD/CAMERA CABLE	50.4CG14.021
	2	LED LCD/CAMERA CABLE	50.4CG14.031
	2	MODEM CABLE	50.4CG04.001
	2	MODEM CABLE	50.4CG04.011
	1	POWER CORD 2.5A 125V USA	27.01518.A11
	1	POWER CORD 2.5A 125V 1.8M BLACK TAIWANESE	27.01518.781
	1	POWER CORD 10A 250V SWISS	27.01518.691
	1	POWER CORD 10A 250V 3PIN SWISS BK	27.01518.581
	1	POWER CORD 10A 250V ARGENTINE	27.01518.0U1
	1	POWER CORD 10A 125V US	27.01518.641
	1	POWER CORD 10A 125V 3PIN US BK	27.01518.521
	1	POWER CORD 7A 250V 2PIN KOREAN	27.01518.531
	1	POWER CORD 3A 250V 3PIN UK	27.03118.001
	1	POWER CORD 5A 250V 3PIN UK BK	27.01518.541
	1	POWER CORD 7A 125V 2PIN JAPAN	27.01518.551
	1	POWER CORD 10A 3PIN BK DENMARK	27.01518.671
	1	POWER CORD 10A 250V 3PIN DENMARK BK	27.01518.561
	1	POWER CORD 10A 250V 3PIN BK SOUTH AFRICA	27.01518.681
	1	POWER CORD 16A 250V SOUTH AFRICA BK	27.01518.571
1	POWER CORD 10A 250V 3PIN CHINA	27.01518.701	

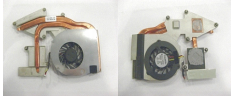

Category	No.	Part Name	Acer Part No.	
<b>CABLES</b>	1	POWER CORD 10A 250V 3PIN CHINA BK	27.01518.591	
	1	POWER CORD 250V 3PIN EUR BK	27.01518.731	
	1	POWER CABLE 16A 250V 3PIN EUR BK	27.01518.601	
	1	POWER CORD 10A 250V 3PIN ITALY	27.01518.711	
	1	POWER CORD 10A 250V 3PIN ITALY BK	27.01518.611	
	1	POWER CORD 2.5A 250V AUSTRALIA	27.01518.621	
	1	POWER CORD 2.5A 250V SOUTH AFRICA BK (INDIA)	27.01518.721	
	1	POWER CORD 10A 250V SOUTH AFRICA BK (INDIA)	27.01518.631	
	1	POWER CORD 7A 125V 2PIN JAPAN BK	27.01518.661	
	1	POWER CORD 250V 10A 3PIN ISRAEL	27.01518.761	
	1	POWER CORD 10A 250V 1.8M BRAZIL BLK	27.01518.A41	
	1	POWER CORD ACA / ACNZ	27.03218.051	
	1	POWER CORD 7.5A 250V 3P AUSTRALIA BK	27.03218.021	
	1	POWER CODE 7A 125V 2PIN JAPAN	27.03518.161	
	1	USB BOARD CABLE	50.4CG05.021	
	1	USB BOARD CABLE	50.4CG05.001	
	1	USB BOARD CABLE	50.4CG05.011	
	1	TOUCHPAD CABLE	50.4CG03.011	
1	TOUCHPAD CABLE	50.4CG03.001		
<b>CAMERA</b> 	2	CAMERA 0.3M SUYIN CN0314-SN30-OV03-5	56.18007.094	
		2	CAMERA 0.3M CHICONY CNF701721004973L	56.18012.094
<b>CASE/COVER/BRACKET ASSEMBLY</b> 	2	BLUE-RAY COMBO BEZEL	42.PAW01.005	
	2	DVD-RW SUPER-MULTI BEZEL	42.PAW01.004	
	2	LCD BEZEL 15.6" W/CAMERA HOLE	60.PAW01.004	
		2	LED LCD BRACKET RIGHT W/HINGE	34.4CG12.001
		2	LED LCD BRACKET RIGHT W/HINGE	34.4CG12.011
		2	LED LCD BRACKET RIGHT W/HINGE	34.4CG12.021
		2	LED LCD BRACKET LEFT W/HINGE	34.4CG13.001
		2	LED LCD BRACKET LEFT W/HINGE	34.4CG13.011
		2	LED LCD BRACKET LEFT W/HINGE	34.4CG13.021
	2	LED LCD COVER IMR 15.6" W/LOGO W/O ANTENNA&3G	60.PAW01.006	
	1	LOWER CASE W/MODEM CABLE&SPEAKER	60.PAW01.001	

Category	No.	Part Name	Acer Part No.
<b>CASE/COVER/BRACKET ASSEMBLY</b> 	1	MIDDLE COVER W/BLUETOOTH BUTTON WITH BLUE LIGHT NONE 3G BUTTON	42.PAW01.001
		2	OPTICAL BRACKET
	1	SD DUMMY CARD	42.TKJ01.001
	1	TOUCHPAD BRACKET	33.PAW01.001
	1	UNITLOAD COVER	42.PAW01.002
	1	UPPER CASE W/LED BUTTON BOARD CABLE&MICROPHONE&SPEAKER&FINGER PRINT HOLE	60.PAX01.001
	1	WIRELESS LAN COVER	42.PAW01.003
<b>CPU/PROCESSOR</b> 	1	CPU AMD TURION RM-74 2.2G 1M 638 35W GRIFFIN B1	KC.TRM02.740
	1	CPU AMD TURION RM72 PGA 2.1G 1M 638 35W GRIFFIN B1	KC.TRM02.720
	1	CPU AMD TURION RM75 PGA 2.2G 1M 638 35W GRIFFIN B1	KC.TRM02.750
	1	CPU AMD ATHLON64X2 QL62 PGA 2.0G 1M 638 35W GRIFFIN B1	KC.AQL02.620
	1	CPU AMD ATHLON64X2 QL-64 2.1G 638 35W GRIFFIN B1	KC.AQL02.640
	1	CPU AMD ATHLON QL65 PGA 2.1G 1M 638 35W GRIFFIN B1	KC.AQL02.650
<b>HDD/HARD DISK DRIVE</b> 	1	HDD MODULE 160GB 5400RPM SATA	
	2	HDD 160GB 5400RPM SATA WD WD1600BEVT-22ZCT0 FW:11.01A11	KH.16007.019
	2	HDD 160GB 5400RPM SATA SEAGATE ST9160310AS F/W:2010	KH.16008.022
	2	HDD 160GB 5400RPM SATA TOSHIBA LIBRA-BS MK1655GSX F/W:FG0101J 5.4	KH.16001.034
	2	HDD 160GB 5400RPM SATA HGST HTS543216L9A300 F/W:C30C	KH.16004.006
	1	HDD MODULE 250GB 5400RPM SATA	
	2	HDD 250GB 5400RPM SATA HGST HTS545025B9A300 PANTHER-B LF F/W:C50K	KH.25008.021
	2	HDD 250GB 5400RPM SATA SEAGATE ST9250315AS LF F/W:0001SDM1	KH.25007.015
	2	HDD 250GB 5400RPM SATA TOSHIBA LIBRA-BS MK2555GSX F/W:FG000J 5.4K	KH.25001.016
	2	HDD 250GB 5400RPM SATA WD WD2500BEVT-22ZCT0 F/W:11.01A11	KH.25004.003
	1	HDD MODULE 320GB 5400RPM SATA	

Category	No.	Part Name	Acer Part No.
HDD/HARD DISK DRIVE	2	HDD 320GB 5400RPM SATA HGST HTS545032B9A300 PANTHER B LF	KH.32008.013
	2	HDD 320GB 5400RPM SATA SEAGATE ST9320320AS F/W:2010	KH.32007.007
	2	HDD 320GB 5400RPM SATA TOSHIBA MK3255GSX LIBRA LF F/W:FG010J	KH.32001.008
	2	HDD 320GB 5400RPM SATA WD WD3200BEVT-22ZCT0 ML125 F/W:01.01A01	KH.32004.002
	1	HDD MODULE 500GB 5400RPM SATA	
	2	HDD 500GB 5400RPM HGST SATA HTS545050B9A300 PANTHER B LF	KH.50008.013
	2	HDD SEAGATE 2.5" 5400RPM 500GB ST9500325AS SATA LF F/W:0001SDM1	KH.50007.009
	2	HDD 500GB 5400RPM SATA TOSHIBA MK5055GSX LIBRA-BS F/W:FG000J LF	KH.50001.011
	2	HDD WD 2.5" 500GB 5400RPM SATA WD5000BEVT-22ZAT0 F/W:01.01A01	KH.50004.001
<b>HEATSINK</b> 	1	CPU HEATSINK DISCRETE W/FAN	60.4CH13.001
	1	CPU HEATSINK DISCRETE W/FAN	60.4CH07.001
	1	CPU HEATSINK DISCRETE W/FAN	60.4CH02.001
<b>KEYBOARD</b> 	1	KEYBOARD 103KEYS NSK-ALA0J AC7T JV50 INTERNAL 17 STANDARD BLACK TEXTURE US-INTERNATIONAL	KB.1170A.056
	1	KEYBOARD 104KEYS NSK-ALA0J AC7T JV50 INTERNAL 17 STANDARD BLACK TEXTURE UK	KB.1170A.055
	1	KEYBOARD 107KEYS NSK-ALA0J AC7T JV50 INTERNAL 17 STANDARD BLACK TEXTURE JAPANESE	KB.1170A.044
	1	KEYBOARD 103KEYS NSK-ALA0J AC7T JV50 INTERNAL 17 STANDARD BLACK TEXTURE GREEK	KB.1170A.041
	1	KEYBOARD 103KEYS NSK-ALA0J AC7T JV50 INTERNAL 17 STANDARD BLACK TEXTURE TAIWAN	KB.1170A.036
	1	KEYBOARD 103KEYS NSK-ALA0J AC7T JV50 INTERNAL 17 STANDARD BLACK TEXTURE THAILAND	KB.1170A.053
	1	KEYBOARD 103KEYS NSK-ALA0J AC7T JV50 INTERNAL 17 STANDARD BLACK TEXTURE HEBREW	KB.1170A.057
	1	KEYBOARD 103KEYS NSK-ALA0J AC7T JV50 INTERNAL 17 STANDARD BLACK TEXTURE ARABIC	KB.1170A.032
	1	KEYBOARD 103KEYS NSK-ALA0J AC7T JV50 INTERNAL 17 STANDARD BLACK TEXTURE RUSSIAN	KB.1170A.048
	1	KEYBOARD 103KEYS NSK-ALA0J AC7T JV50 INTERNAL 17 STANDARD BLACK TEXTURE KOREA	TBD
	1	KEYBOARD 103KEYS NSK-ALA0J AC7T JV50 INTERNAL 17 STANDARD BLACK TEXTURE BLANK	TBD
	1	KEYBOARD 104KEYS NSK-ALA0J AC7T JV50 INTERNAL 17 STANDARD BLACK TEXTURE SWEDISH	KB.1170A.051
	1	KEYBOARD 104KEYS NSK-ALA0J AC7T JV50 INTERNAL 17 STANDARD BLACK TEXTURE FRENCH	KB.1170A.039
	1	KEYBOARD 104KEYS NSK-ALA0J AC7T JV50 INTERNAL 17 STANDARD BLACK TEXTURE PORTUGAL	KB.1170A.047
	1	KEYBOARD 104KEYS NSK-ALA0J AC7T JV50 INTERNAL 17 STANDARD BLACK TEXTURE SLOVE	KB.1170A.049
	1	KEYBOARD 104KEYS NSK-ALA0J AC7T JV50 INTERNAL 17 STANDARD BLACK TEXTURE BRAZILIAN PORTUGUESE	KB.1170A.034
	1	KEYBOARD 104KEYS NSK-ALA0J AC7T JV50 INTERNAL 17 STANDARD BLACK TEXTURE SWISS	KB.1170A.052
	1	KEYBOARD 104KEYS NSK-ALA0J AC7T JV50 INTERNAL 17 STANDARD BLACK TEXTURE DANISH	KB.1170A.037
	1	KEYBOARD 104KEYS NSK-ALA0J AC7T JV50 INTERNAL 17 STANDARD BLACK TEXTURE ITALIAN	KB.1170A.043

Category	No.	Part Name	Acer Part No.
<b>KEYBOARD</b>	1	KEYBOARD 104KEYS NSK-ALA0J AC7T JV50 INTERNAL 17 STANDARD BLACK TEXTURE BELGIAN	KB.I170A.033
	1	KEYBOARD 104KEYS NSK-ALA0J AC7T JV50 INTERNAL 17 STANDARD BLACK TEXTURE GERMAN	KB.I170A.040
	1	KEYBOARD 104KEYS NSK-ALA0J AC7T JV50 INTERNAL 17 STANDARD BLACK TEXTURE CZECH	TBD
	1	KEYBOARD 104KEYS NSK-ALA0J AC7T JV50 INTERNAL 17 STANDARD BLACK TEXTURE FRENCH CANADIAN	TBD
	1	KEYBOARD 104KEYS NSK-ALA0J AC7T JV50 INTERNAL 17 STANDARD BLACK TEXTURE NORWEGIAN	KB.I170A.046
	1	KEYBOARD 104KEYS NSK-ALA0J AC7T JV50 INTERNAL 17 STANDARD BLACK TEXTURE HUNGARIAN	KB.I170A.042
	1	KEYBOARD 104KEYS NSK-ALA0J AC7T JV50 INTERNAL 17 STANDARD BLACK TEXTURE SPANISH	KB.I170A.050
	1	KEYBOARD 104KEYS NSK-ALA0J AC7T JV50 INTERNAL 17 STANDARD BLACK TEXTURE TURKISH	KB.I170A.054
	1	KEYBOARD 104KEYS NSK-ALA0J AC7T JV50 INTERNAL 17 STANDARD BLACK TEXTURE NORDIC	KB.I170A.045
	1	KEYBOARD 104KEYS NSK-ALA0J AC7T JV50 INTERNAL 17 STANDARD BLACK TEXTURE FRENCH ARABIC	KB.I170A.038
	1	KEYBOARD 104KEYS NSK-ALA0J AC7T JV50 INTERNAL 17 STANDARD BLACK TEXTURE FRENCH CANADIAN	KB.I170A.058
	1	KEYBOARD 104KEYS NSK-ALA0J AC7T JV50 INTERNAL 17 STANDARD BLACK TEXTURE CZECH/SLOVAK	KB.I170A.035
	1	KEYBOARD 104KEYS NSK-ALA0J AC7T JV50 INTERNAL 17 STANDARD BLACK TEXTURE SLOVAK	TBD
	1	KEYBOARD 104KEYS NSK-ALA0J AC7T JV50 INTERNAL 17 STANDARD BLACK TEXTURE BLANK	TBD
<b>LCD</b> 	1	LED LCD MODULE 15.6" WXGA GLARE W/ ANTENNA*2&CAMERA (NONE 3G)	6M.PAW01.003
	2	LED LCD 15.6" WXGA GLARE CMO N156B6-L04 LF 220NIT 8MS 500:1	LK.15608.002
	2	LED LCD 15.6" WXGA GLARE SAMSUNG LTN156AT02-A01 LF 220NIT 8MS 500:1	LK.1560D.005
	2	LED LCD 15.6" WXGA GLARE AUO B156XW02 V0 LF 220NIT 8MS 500:1	LK.15606.003
	2	LED LCD 15.6" WXGA GLARE LG LP156WH2-TLE1 LF 220NIT 8MS 400:1	LK.15605.003
	1	LED LCD MODULE 15.6" WXGA GLARE W/CAMERA W/O ANTENNA (NONE 3G)	6M.PAW01.004
	<b>MICROPHONE</b>	2	MICROPHONE
2		MICROPHONE	23.42231.001
2		MICROPHONE	23.40544.001
2		MICROPHONE	23.42238.001
<b>MAINBOARD</b> 	1	MAINBOARD AS5536G ATI RS780 SB700 M92M-XT 512MB LF W/RTC BATTERY&MODEM BOARD	MB.P4201.002
<b>ODD</b> 	1	BLU-RAY COMBO MODULE 4X SATA	6M.PAW01.001
	2	ODD HLDS BD COMBO 12.7MM TRAY DL 4X CT10 LF W/O BEZEL SATA	KO.00405.002
	2	ODD PLDS BD COMBO 12.7MM TRAY DL 4X DS-4E1S LF W/O BEZEL SATA	KO.0040D.002
	2	ODD PIONEER BD COMBO 12.7 SATA DL 4X BDC-TD01RS LF W/O BEZEL SATA	KO.0040F.001
	1	DVD-RW SUPER-MULTI MODULE 8X SATA	6M.PAW01.002

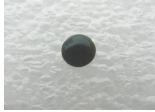
Category	No.	Part Name	Acer Part No.
<b>ODD</b>	2	ODD SONY SUPER-MULTI DRIVE 12.7MM TRAY DL 8X AD-7580S LF W/O BEZEL SATA	KU.0080F.004
	2	ODD TOSHIBA SUPER-MULTI DRIVE 12.7MM TRAY DL 8X SATA TS-L633B LF W/O BEZEL	KU.0080E.017
	2	ODD SONY SUPER-MULTI DRIVE 12.7MM TRAY DL 8X AD-7590S LF W/O BEZEL SATA	KU.00801.030
	2	ODD HLDS SUPER-MULTI DRIVE 12.7MM TRAY DL 8X GT20N LF W/O BEZEL SATA	KU.0080E.025
	2	ODD PLDS SUPER-MULTI DRIVE 12.7MM TRAY DL 8X SATA DS-8A3S LF W/O BEZEL	KU.0080D.040
<b>MEMORY</b> 	1	SODIMM 1GB DDRII667 NANYA NT1GT64UH8D0FN-3C LF (0.07U)	KN.1GB0G.022
	1	SODIMM 1GB DDRII667 MICRON MT8HTF12864HDY-667G1 LF	KN.1GB03.026
	1	SODIMM 1GB DDRII667 SAMSUNG M470T2864EH3-CE6 LF	KN.1GB04.010
	1	SODIMM 1GB DDRII667 HYNIX HMP112S6EFR6C-Y5 LF	KN.1GB0B.027
	1	SODIMM 2GB DDRII667 SAMSUNG M470T5663EH3-CE6 LF	KN.2GB0G.012
	1	SODIMM 2GB DDRII667 NANYA NT2GT64U8HD0BN-3C LF (0.07U)	KN.2GB0B.011
	1	SODIMM 2GB DDRII667 MICRON MT16HTF25664HY-667G1 LF	KN.2GB03.011
	1	SODIMM 2GB DDRII667 HYNIX HMP125S6EFR8C-Y5 LF	KN.2GB04.010
<b>MISCELLANEOUS</b> 	1	LCD SCREW RUBBER	47.AU401.001
	1	NAME PLATE AS5536G	40.PB101.001
<b>SCREWS</b>	1	SCREW	86.00E12.536
	1	SCREW	86.00E34.738
	1	SCREW	86.1Z533.100
	1	SCREW	86.9A522.3R0
	1	SCREW	86.9A552.4R0
	1	SCREW	86.9A554.4R0
<b>SPEAKER</b>	2	SPEAKER ON LOWER CASE	23.40536.001
	2	SPEAKER ON LOWER CASE	23.40539.001
	2	SPEAKER ON UPPER CASE	23.40543.001
	2	SPEAKER ON UPPER CASE	23.40535.001
	2	SPEAKER ON UPPER CASE	23.40542.001

# Model Definition and Configuration

---

# Aspire 5738G/5738ZG/5738Z/5738/5338 Series

**NOTE:** All models have following common specifications: Card reader (5-in-1), Battery (6CELL2.2), Adapter (65W)

Model	RO	Country	Acer Part No	Description	CPU	LCD	VGA Chip	VRAM 1	Memory 1/ Memory 2	HDD 1(GB)	ODD	WLAN	WLAN1	Bluetooth	Finger- print	Camera
AS5338-161G16Mn	PA	ACLA-Portuguese	LX.PCU0C.003	AS5338-161G16Mn LINPUSAXC2 UMACbb 1*1G/160/6L/5R/CB_bgn_0.3D_EN62	CMT1600	NLED15.6WXGAG	UMA	N	SO1GBIII10/N	N160GB5.4KS	NSM8XS	3rd WiFi 1x2 BGN	3rd WiFi 1x2 BGN	N	N	0.3M DV
AS5338-161G16Mn	PA	USA	LX.PCU0C.004	AS5338-161G16Mn LINPUS AUS1 UMACbb 1*1G/160/6L/5R/CB_bgn_0.3D_EN31	CMT1600	NLED15.6WXGAG	UMA	N	SO1GBIII10/N	N160GB5.4KS	NSM8XS	3rd WiFi 1x2 BGN	3rd WiFi 1x2 BGN	N	N	0.3M DV
AS5338-161G16Mn	PA	ACLA-Spanish	LX.PCU0C.001	AS5338-161G16Mn LINPUSAEA3 UMACbb 1*1G/160/6L/5R/CB_bgn_0.3D_EN61	CMT1600	NLED15.6WXGAG	UMA	N	SO1GBIII10/N	N160GB5.4KS	NSM8XS	3rd WiFi 1x2 BGN	3rd WiFi 1x2 BGN	N	N	0.3M DV
AS5338-161G16Mn	PA	ACLA-Spanish	LX.PCU0C.002	AS5338-161G16Mn LINPUSAEA1 UMACbb 1*1G/160/6L/5R/CB_bgn_0.3D_EN61	CMT1600	NLED15.6WXGAG	UMA	N	SO1GBIII10/N	N160GB5.4KS	NSM8XS	3rd WiFi 1x2 BGN	3rd WiFi 1x2 BGN	N	N	0.3M DV
AS5338-162G25Mn	PA	ACLA-Portuguese	LX.PCU0X.003	AS5338-162G25Mn EM VHP32ATXC2 MC UMACbb 2*1G/250/6L/5R/CB_bgn_0.3D_XC21	CMT1600	NLED15.6WXGAG	UMA	N	SO1GBIII10	N250GB5.4KS	NSM8XS	3rd WiFi 1x2 BGN	3rd WiFi 1x2 BGN	N	N	0.3M DV
AS5338-162G25Mn	PA	ACLA-Portuguese	LX.PCU0Y.006	AS5338-162G25Mn EM VHB32ATXC1 MC UMACbb 2*1G/250/6L/5R/CB_bgn_0.3D_XC22	CMT1600	NLED15.6WXGAG	UMA	N	SO1GBIII10	N250GB5.4KS	NSM8XS	3rd WiFi 1x2 BGN	3rd WiFi 1x2 BGN	N	N	0.3M DV
AS5338-162G16Mn	PA	ACLA-Portuguese	LX.PCU0Y.003	AS5338-162G16Mn EM VHB32ATXC2 MC UMACbb 2*1G/160/6L/5R/CB_bgn_0.3D_XC21	CMT1600	NLED15.6WXGAG	UMA	N	SO1GBIII10	N160GB5.4KS	NSM8XS	3rd WiFi 1x2 BGN	3rd WiFi 1x2 BGN	N	N	0.3M DV
AS5338-162G25Mn	PA	ACLA-Spanish	LX.PCU0Y.004	AS5338-162G25Mn EM VHB32ATEA1 MC UMACbb 2*1G/250/6L/5R/CB_bgn_0.3D_ES22	CMT1600	NLED15.6WXGAG	UMA	N	SO1GBIII10	N250GB5.4KS	NSM8XS	3rd WiFi 1x2 BGN	3rd WiFi 1x2 BGN	N	N	0.3M DV
AS5338-162G25Mn	PA	ACLA-Spanish	LX.PCU0X.001	AS5338-162G25Mn EM VHP32ATEA1 MC UMACbb 2*1G/250/6L/5R/CB_bgn_0.3D_ES22	CMT1600	NLED15.6WXGAG	UMA	N	SO1GBIII10	N250GB5.4KS	NSM8XS	3rd WiFi 1x2 BGN	3rd WiFi 1x2 BGN	N	N	0.3M DV
AS5338-162G25Mn	PA	ACLA-Spanish	LX.PCU0X.002	AS5338-162G25Mn EM VHP32ATEA3 MC UMACbb 2*1G/250/6L/5R/CB_bgn_0.3D_ES22	CMT1600	NLED15.6WXGAG	UMA	N	SO1GBIII10	N250GB5.4KS	NSM8XS	3rd WiFi 1x2 BGN	3rd WiFi 1x2 BGN	N	N	0.3M DV
AS5338-162G16Mn	PA	ACLA-Spanish	LX.PCU0Y.001	AS5338-162G16Mn EM VHB32ATEA1 MC UMACbb 2*1G/160/6L/5R/CB_bgn_0.3D_ES22	CMT1600	NLED15.6WXGAG	UMA	N	SO1GBIII10	N160GB5.4KS	NSM8XS	3rd WiFi 1x2 BGN	3rd WiFi 1x2 BGN	N	N	0.3M DV
AS5338-162G16Mn	PA	ACLA-Spanish	LX.PCU0Y.002	AS5338-162G16Mn EM VHB32ATEA3 MC UMACbb 2*1G/160/6L/5R/CB_bgn_0.3D_ES22	CMT1600	NLED15.6WXGAG	UMA	N	SO1GBIII10	N160GB5.4KS	NSM8XS	3rd WiFi 1x2 BGN	3rd WiFi 1x2 BGN	N	N	0.3M DV
AS5338-162G25Mn	PA	ACLA-Spanish	LX.PCU0Y.005	AS5338-162G25Mn EM VHB32ATEA3 MC UMACbb 2*1G/250/6L/5R/CB_bgn_0.3D_ES22	CMT1600	NLED15.6WXGAG	UMA	N	SO1GBIII10	N250GB5.4KS	NSM8XS	3rd WiFi 1x2 BGN	3rd WiFi 1x2 BGN	N	N	0.3M DV
AS5338-162G16Mn	AAP	Australia/ New Zealand	LX.PCU0Y.010	AS5338-162G16Mn VHB32ATAU1 MC UMACbb 1*2G/160/6L/5R/CB_bgn_0.3D_EN12	CMT1600	NLED15.6WXGAG	UMA	N	SO2GBIII10/N	N160GB5.4KS	NSM8XS	3rd WiFi 1x2 BGN	3rd WiFi 1x2 BGN	N	N	0.3M DV
AS5338-161G16Mn	AAP	Australia/ New Zealand	LX.PCU0Y.009	AS5338-161G16Mn VHB32ATAU1 MC UMACbb 1*1G/160/6L/5R/CB_bgn_0.3D_EN12	CMT1600	NLED15.6WXGAG	UMA	N	SO1GBIII10/N	N160GB5.4KS	NSM8XS	3rd WiFi 1x2 BGN	3rd WiFi 1x2 BGN	N	N	0.3M DV
AS5338-162G25Mn	AAP	Australia/ New Zealand	LX.PCU0Y.008	AS5338-162G25Mn VHB32ATAU1 MC UMACbb 1*2G/250/6L/5R/CB_bgn_0.3D_EN12	CMT1600	NLED15.6WXGAG	UMA	N	SO2GBIII10/N	N250GB5.4KS	NSM8XS	3rd WiFi 1x2 BGN	3rd WiFi 1x2 BGN	N	N	0.3M DV
AS5338-161G25Mn	AAP	Australia/ New Zealand	LX.PCU0Y.007	AS5338-161G25Mn VHB32ATAU1 MC UMACbb 1*1G/250/6L/5R/CB_bgn_0.3D_EN12	CMT1600	NLED15.6WXGAG	UMA	N	SO1GBIII10/N	N250GB5.4KS	NSM8XS	3rd WiFi 1x2 BGN	3rd WiFi 1x2 BGN	N	N	0.3M DV
AS5736G-664G32Mn	WW	WW	S2.P400X.001	AS5736G-664G32Mn VHP32AWW1 MC N10MGE1512C 2*2G/320/6L/CB_n3_0.3D_EN11	C2DT6600	N15.6WXGAG	N10MG E1	512M-DDR2(64*16*4)	SO2GBIII10	N320GB5.4KS	NSM8XS	SP3x3MM W	SP3x3MM W	N	AES1610	0.3M DV
AS5738G-644G32Mn	AAP	Australia/ New Zealand	LX.PAN0X.012	AS5738G-644G32Mn VHP32ATAU1 MC N10MGE1512CFbb 2*2G/320/6L/5R/CB_n2_FP_0.3D_EN12	C2DT6400	NLED15.6WXGAG	N10MG E1	512M-DDR2(64*16*4)	SO2GBIII10	N320GB5.4KS	NSM8XS	SP1x2MM W	SP1x2MM W	BT 2.0	AES1610	0.3M DV

Model	RO	Country	Acer Part No	Description	CPU	LCD	VGA Chip	VRAM 1	Memory 1/ Memory 2	HDD 1(GB)	ODD	WLAN	WLAN1	Bluetooth	Finger- print	Camera
AS5738G-664G50Bn	AAP	Australia/ New Zealand	LX.PAN0X.002	AS5738G-664G50Bn VHP32ATAU1 MC N10MGE1512CFbbM 2*2G/500_L/BT/6L/5R/CB_n2_FP_0.3D_EN12	C2DT6600	NLED15.6WXGAG	N10MG E1	512M-DDR2(6 4*16*4)	SO2GBIII10	N500GB5.4KS	NBDCB4 XS	SP1x2MM W	SP1x2MM W	BT 2.0	AES161 0	0.3M DV
AS5738G-642G32Mn	AAP	Australia/ New Zealand	LX.PAN0X.011	AS5738G-642G32Mn VHP32ATAU1 MC N10MGE1512CFbbM 1*2G/320/BT/6L/5R/CB_n2_FP_0.3D_EN12	C2DT6400	NLED15.6WXGAG	N10MG E1	512M-DDR2(6 4*16*4)	SO2GBIII10/N	N320GB5.4KS	NSM8XS	SP1x2MM W	SP1x2MM W	BT 2.0	AES161 0	0.3M DV
AS5738G-642G50Mn	AAP	Australia/ New Zealand	LX.PAN0X.010	AS5738G-642G50Mn VHP32ATAU1 MC N10MGE1512CFbbM 1*2G/500_L/BT/6L/5R/CB_n2_FP_0.3D_EN12	C2DT6400	NLED15.6WXGAG	N10MG E1	512M-DDR2(6 4*16*4)	SO2GBIII10/N	N500GB5.4KS	NSM8XS	SP1x2MM W	SP1x2MM W	BT 2.0	AES161 0	0.3M DV
AS5738G-744G50Mn	AAP	Australia/ New Zealand	LX.PAN0X.008	AS5738G-744G50Mn VHP32ATAU1 MC N10MGE1512CFbbM 2*2G/500_L/BT/6L/5R/CB_n2_FP_0.3D_EN12	C2DP7450	NLED15.6WXGAG	N10MG E1	512M-DDR2(6 4*16*4)	SO2GBIII10	N500GB5.4KS	NSM8XS	SP1x2MM W	SP1x2MM W	BT 2.0	AES161 0	0.3M DV
AS5738G-663G50Mn	AAP	Australia/ New Zealand	LX.PAN0X.006	AS5738G-663G50Mn VHP32ATAU1 MC N10MGE1512CFbbM 2G+1G/500_L/BT/6L/5R/CB_n2_FP_0.3D_EN12	C2DT6600	NLED15.6WXGAG	N10MG E1	512M-DDR2(6 4*16*4)	SO2GBIII10	N500GB5.4KS	NSM8XS	SP1x2MM W	SP1x2MM W	BT 2.0	AES161 0	0.3M DV
AS5738G-643G50Mn	AAP	Australia/ New Zealand	LX.PAN0X.004	AS5738G-643G50Mn VHP32ATAU1 MC N10MGE1512CFbbM 2G+1G/500_L/BT/6L/5R/CB_n2_FP_0.3D_EN12	C2DT6400	NLED15.6WXGAG	N10MG E1	512M-DDR2(6 4*16*4)	SO2GBIII10	N500GB5.4KS	NSM8XS	SP1x2MM W	SP1x2MM W	BT 2.0	AES161 0	0.3M DV
AS5738G-744G50Bn	AAP	Australia/ New Zealand	LX.PAN0X.003	AS5738G-744G50Bn VHP32ATAU1 MC N10MGE1512CFbbM 2*2G/500_L/BT/6L/5R/CB_n2_FP_0.3D_EN12	C2DP7450	NLED15.6WXGAG	N10MG E1	512M-DDR2(6 4*16*4)	SO2GBIII10	N500GB5.4KS	NBDCB4 XS	SP1x2MM W	SP1x2MM W	BT 2.0	AES161 0	0.3M DV
AS5738G-643G32Mn	AAP	Australia/ New Zealand	LX.PAN0X.005	AS5738G-643G32Mn VHP32ATAU1 MC N10MGE1512CFbbM 2G+1G/320/BT/6L/5R/CB_n2_FP_0.3D_EN12	C2DT6400	NLED15.6WXGAG	N10MG E1	512M-DDR2(6 4*16*4)	SO2GBIII10	N320GB5.4KS	NSM8XS	SP1x2MM W	SP1x2MM W	BT 2.0	AES161 0	0.3M DV
AS5738G-664G50Mn	AAP	Australia/ New Zealand	LX.PAN0X.007	AS5738G-664G50Mn VHP32ATAU1 MC N10MGE1512CFbbM 2*2G/500_L/BT/6L/5R/CB_n2_FP_0.3D_EN12	C2DT6600	NLED15.6WXGAG	N10MG E1	512M-DDR2(6 4*16*4)	SO2GBIII10	N500GB5.4KS	NSM8XS	SP1x2MM W	SP1x2MM W	BT 2.0	AES161 0	0.3M DV
AS5738G-644G50Mn	AAP	Australia/ New Zealand	LX.PAN0X.009	AS5738G-644G50Mn VHP32ATAU1 MC N10MGE1512CFbbM 2*2G/500_L/BT/6L/5R/CB_n2_FP_0.3D_EN12	C2DT6400	NLED15.6WXGAG	N10MG E1	512M-DDR2(6 4*16*4)	SO2GBIII10	N500GB5.4KS	NSM8XS	SP1x2MM W	SP1x2MM W	BT 2.0	AES161 0	0.3M DV
AS5738G-642G32Mn	TW N	GCTWN	LX.PAN0X.001	AS5738G-642G32Mn VHP32ATTW1 MC N10MGE1512CFbbM 1*2G/320/BT/6L/5R/CB_n2_FP_0.3D_TC11	C2DT6400	NLED15.6WXGAG	N10MG E1	512M-DDR2(6 4*16*4)	SO2GBIII10	N320GB5.4KS	NSM8XS	SP1x2MM W	SP1x2MM W	BT 2.0	AES161 0	0.3M DV
AS5738G-644G32Mi	EME A	Russia	LX.PAM0X.051	AS5738G-644G32Mi VHP32ATRU1 MC N10MGE1512Cbb 2*2G/320/BT/6L/5R/CB_abg_0.3D_RU11	C2DT6400	NLED15.6WXGAG	N10MG E1	512M-DDR2(6 4*16*4)	SO2GBIII10	N320GB5.4KS	NSM8XS	SP1x2MM W	SP1x2MA BG	BT 2.0	N	0.3M DV
AS5738G-642G25Mn	EME A	Poland	LX.PAM0C.005	AS5738G-642G25Mn LINPUSAPL1 N10MGE1512Cbb 1*2G/250/BT/6L/5R/CB_n2_0.3D_EN41	C2DT6400	NLED15.6WXGAG	N10MG E1	512M-DDR2(6 4*16*4)	SO2GBIII10/N	N250GB5.4KS	NSM8XS	SP1x2MM W	SP1x2MM W	BT 2.0	N	0.3M DV
AS5738G-643G32Mn	EME A	Poland	LX.PAM0C.004	AS5738G-643G32Mn LINPUSAPL1 N10MGE1512Cbb 2G+1G/320/BT/6L/5R/CB_n2_0.3D_EN41	C2DT6400	NLED15.6WXGAG	N10MG E1	512M-DDR2(6 4*16*4)	SO2GBIII10	N320GB5.4KS	NSM8XS	SP1x2MM W	SP1x2MM W	BT 2.0	N	0.3M DV
AS5738G-643G32Mn	EME A	Middle East	LX.PAM0C.003	AS5738G-643G32Mn LINPUSAME4 N10MGE1512Cbb 2G+1G/320/BT/6L/5R/CB_n2_0.3D_EN72	C2DT6400	NLED15.6WXGAG	N10MG E1	512M-DDR2(6 4*16*4)	SO2GBIII10	N320GB5.4KS	NSM8XS	SP1x2MM W	SP1x2MM W	BT 2.0	N	0.3M DV
AS5738G-744G50Mn	EME A	Spain	LX.PAM0X.050	AS5738G-744G50Mn VHP32ATES1 MC N10MGE1512Cbb 2*2G/500_L/6L/5R/CB_n2_0.3D_ES22	C2DP7450	NLED15.6WXGAG	N10MG E1	512M-DDR2(6 4*16*4)	SO2GBIII10	N500GB5.4KS	NSM8XS	SP1x2MM W	SP1x2MM W	N	N	0.3M DV
AS5738G-644G32Mn	EME A	Eastern Europe	LX.PAM0X.030	AS5738G-644G32Mn VHP32ATEU5 MC N10MGE1512CbbM 2*2G/320/6L/5R/CB_n2_0.3D_RO12	C2DT6400	NLED15.6WXGAG	N10MG E1	512M-DDR2(6 4*16*4)	SO2GBIII10	N320GB5.4KS	NSM8XS	SP1x2MM W	SP1x2MM W	N	N	0.3M DV
AS5738G-642G32Mn	AAP	Australia/ New Zealand	LX.PAM0X.049	AS5738G-642G32Mn VHP32ATAU1 MC N10MGE1512CbbM 1*2G/320/6L/5R/CB_n2_0.3D_EN12	C2DT6400	NLED15.6WXGAG	N10MG E1	512M-DDR2(6 4*16*4)	SO2GBIII10/N	N320GB5.4KS	NSM8XS	SP1x2MM W	SP1x2MM W	N	N	0.3M DV



Model	RO	Country	Acer Part No	Description	CPU	LCD	VGA Chip	VRAM 1	Memory 1/ Memory 2	HDD 1(GB)	ODD	WLAN	WLAN1	Bluetooth	Finger- print	Camera
AS5738G-643G32Mn	EME A	Middle East	LX.PAM0C.001	AS5738G-643G32Mn LINPUSAME7 N10MGE1512CbbM 2G+1G/320/6L/5R/ CB_n2_0.3D_EN12	C2DT6400	NLED15.6WXGAG	N10MG E1	512M-DDR2(6 4*16*4)	SO2GBIII10	N320GB5.4KS	NSM8XS	SP1x2MM W	SP1x2MM W	BT 2.0	N	0.3M DV
AS5738G-643G32Mn	EME A	Middle East	LX.PAM0C.002	AS5738G-643G32Mn LINPUSAME2 N10MGE1512CbbM 2G+1G/320/6L/5R/ CB_n2_0.3D_EN13	C2DT6400	NLED15.6WXGAG	N10MG E1	512M-DDR2(6 4*16*4)	SO2GBIII10	N320GB5.4KS	NSM8XS	SP1x2MM W	SP1x2MM W	BT 2.0	N	0.3M DV
AS5738G-644G32Mn	EME A	Russia	LX.PAM0X.025	AS5738G-644G32Mn VHP32ATRU1 MC N10MGE1512CbbM 2*2G/320/6L/5R/ CB_n2_0.3D_RU11	C2DT6400	NLED15.6WXGAG	N10MG E1	512M-DDR2(6 4*16*4)	SO2GBIII10	N320GB5.4KS	NSM8XS	SP1x2MM W	SP1x2MM W	N	N	0.3M DV
AS5738G-644G32Mn	EME A	Belgium	LX.PAM0X.036	AS5738G-644G32Mn VHP32ATBE1 MC N10MGE1512CbbM 2*2G/320/6L/5R/ CB_n2_0.3D_NL13	C2DT6400	NLED15.6WXGAG	N10MG E1	512M-DDR2(6 4*16*4)	SO2GBIII10	N320GB5.4KS	NSM8XS	SP1x2MM W	SP1x2MM W	N	N	0.3M DV
AS5738G-644G32Mn	EME A	Middle East	LX.PAM0X.018	AS5738G-644G32Mn EM VHP32ATME4 MC N10MGE1512CbbM 2*2G/320/6L/5R/ CB_n2_0.3D_EN11	C2DT6400	NLED15.6WXGAG	N10MG E1	512M-DDR2(6 4*16*4)	SO2GBIII10	N320GB5.4KS	NSM8XS	SP1x2MM W	SP1x2MM W	N	N	0.3M DV
AS5738G-644G32Mn	EME A	Austria	LX.PAM0X.026	AS5738G-644G32Mn VHP32ATAT1 MC N10MGE1512CbbM 2*2G/320/6L/5R/ CB_n2_0.3D_DE11	C2DT6400	NLED15.6WXGAG	N10MG E1	512M-DDR2(6 4*16*4)	SO2GBIII10	N320GB5.4KS	NSM8XS	SP1x2MM W	SP1x2MM W	N	N	0.3M DV
AS5738G-644G32Mn	EME A	Germany	LX.PAM0X.035	AS5738G-644G32Mn VHP32ATDE1 MC N10MGE1512CbbM 2*2G/320/6L/5R/ CB_n2_0.3D_DE13	C2DT6400	NLED15.6WXGAG	N10MG E1	512M-DDR2(6 4*16*4)	SO2GBIII10	N320GB5.4KS	NSM8XS	SP1x2MM W	SP1x2MM W	N	N	0.3M DV
AS5738G-644G32Mn	EME A	Eastern Europe	LX.PAM0X.031	AS5738G-644G32Mn VHP32ATEU7 MC N10MGE1512CbbM 2*2G/320/6L/5R/ CB_n2_0.3D_ENR2	C2DT6400	NLED15.6WXGAG	N10MG E1	512M-DDR2(6 4*16*4)	SO2GBIII10	N320GB5.4KS	NSM8XS	SP1x2MM W	SP1x2MM W	N	N	0.3M DV
AS5738G-644G32Mn	EME A	Eastern Europe	LX.PAM0X.029	AS5738G-644G32Mn VHP32ATEU7 MC N10MGE1512CbbM 2*2G/320/6L/5R/ CB_n2_0.3D_SL11	C2DT6400	NLED15.6WXGAG	N10MG E1	512M-DDR2(6 4*16*4)	SO2GBIII10	N320GB5.4KS	NSM8XS	SP1x2MM W	SP1x2MM W	N	N	0.3M DV
AS5738G-644G32Mn	EME A	Greece	LX.PAM0X.020	AS5738G-644G32Mn VHP32ATGR1 MC N10MGE1512CbbM 2*2G/320/6L/5R/ CB_n2_0.3D_EL32	C2DT6400	NLED15.6WXGAG	N10MG E1	512M-DDR2(6 4*16*4)	SO2GBIII10	N320GB5.4KS	NSM8XS	SP1x2MM W	SP1x2MM W	N	N	0.3M DV
AS5738G-644G32Mn	EME A	Middle East	LX.PAM0X.016	AS5738G-644G32Mn EM VHP32ATME3 MC N10MGE1512CbbM 2*2G/320/6L/5R/ CB_n2_0.3D_FR23	C2DT6400	NLED15.6WXGAG	N10MG E1	512M-DDR2(6 4*16*4)	SO2GBIII10	N320GB5.4KS	NSM8XS	SP1x2MM W	SP1x2MM W	N	N	0.3M DV
AS5738G-644G32Mn	EME A	South Africa	LX.PAM0X.047	AS5738G-644G32Mn EM VHP32ATZA1 MC N10MGE1512CbbM 2*2G/320/6L/5R/ CB_n2_0.3D_FR23	C2DT6400	NLED15.6WXGAG	N10MG E1	512M-DDR2(6 4*16*4)	SO2GBIII10	N320GB5.4KS	NSM8XS	SP1x2MM W	SP1x2MM W	N	N	0.3M DV
AS5738G-644G32Mn	EME A	Hungary	LX.PAM0X.041	AS5738G-644G32Mn VHP32ATHU1 MC N10MGE1512CbbM 2*2G/320/6L/5R/ CB_n2_0.3D_HU13	C2DT6400	NLED15.6WXGAG	N10MG E1	512M-DDR2(6 4*16*4)	SO2GBIII10	N320GB5.4KS	NSM8XS	SP1x2MM W	SP1x2MM W	N	N	0.3M DV
AS5738G-644G32Mn	EME A	Italy	LX.PAM0X.019	AS5738G-644G32Mn VHP32ATIT1 MC N10MGE1512CbbM 2*2G/320/6L/5R/ CB_n2_0.3D_IT12	C2DT6400	NLED15.6WXGAG	N10MG E1	512M-DDR2(6 4*16*4)	SO2GBIII10	N320GB5.4KS	NSM8XS	SP1x2MM W	SP1x2MM W	N	N	0.3M DV
AS5738G-644G32Mn	EME A	Norway	LX.PAM0X.039	AS5738G-644G32Mn VHP32ATNO1 MC N10MGE1512CbbM 2*2G/320/6L/5R/ CB_n2_0.3D_NO12	C2DT6400	NLED15.6WXGAG	N10MG E1	512M-DDR2(6 4*16*4)	SO2GBIII10	N320GB5.4KS	NSM8XS	SP1x2MM W	SP1x2MM W	N	N	0.3M DV
AS5738G-644G32Mn	EME A	Spain	LX.PAM0X.042	AS5738G-644G32Mn VHP32ATES1 MC N10MGE1512CbbM 2*2G/320/6L/5R/ CB_n2_0.3D_ES22	C2DT6400	NLED15.6WXGAG	N10MG E1	512M-DDR2(6 4*16*4)	SO2GBIII10	N320GB5.4KS	NSM8XS	SP1x2MM W	SP1x2MM W	N	N	0.3M DV
AS5738G-644G32Mn	EME A	Middle East	LX.PAM0X.015	AS5738G-644G32Mn EM VHP32ATME2 MC N10MGE1512CbbM 2*2G/320/6L/5R/ CB_n2_0.3D_AR23	C2DT6400	NLED15.6WXGAG	N10MG E1	512M-DDR2(6 4*16*4)	SO2GBIII10	N320GB5.4KS	NSM8XS	SP1x2MM W	SP1x2MM W	N	N	0.3M DV
AS5738G-644G32Mn	EME A	Middle East	LX.PAM0X.017	AS5738G-644G32Mn EM VHP32ATME2 MC N10MGE1512CbbM 2*2G/320/6L/5R/ CB_n2_0.3D_AR13	C2DT6400	NLED15.6WXGAG	N10MG E1	512M-DDR2(6 4*16*4)	SO2GBIII10	N320GB5.4KS	NSM8XS	SP1x2MM W	SP1x2MM W	N	N	0.3M DV

Model	RO	Country	Acer Part No	Description	CPU	LCD	VGA Chip	VRAM 1	Memory 1/ Memory 2	HDD 1(GB)	ODD	WLAN	WLAN1	Bluetooth	Finger- print	Camera
AS5738G-644G32Mn	EME A	Middle East	LX.PAM0X.046	AS5738G-644G32Mn EM VHP32ATME2 MC N10MGE1512CbbM 2*2G/320/6L/5R/ CB_n2_0.3D_EN15	C2DT6400	NLED15.6WXGAG	N10MG E1	512M-DDR2(6 4*16*4)	SO2GBIII10	N320GB5.4KS	NSM8XS	SP1x2MM W	SP1x2MM W	N	N	0.3M DV
AS5738G-644G32Mn	EME A	Middle East	LX.PAM0X.044	AS5738G-644G32Mn EM VHP32ATME9 MC N10MGE1512CbbM 2*2G/320/6L/5R/ CB_n2_0.3D_FR22	C2DT6400	NLED15.6WXGAG	N10MG E1	512M-DDR2(6 4*16*4)	SO2GBIII10	N320GB5.4KS	NSM8XS	SP1x2MM W	SP1x2MM W	N	N	0.3M DV
AS5738G-644G32Mn	EME A	Denmark	LX.PAM0X.033	AS5738G-644G32Mn VHP32ATDK1 MC N10MGE1512CbbM 2*2G/320/6L/5R/ CB_n2_0.3D_NO13	C2DT6400	NLED15.6WXGAG	N10MG E1	512M-DDR2(6 4*16*4)	SO2GBIII10	N320GB5.4KS	NSM8XS	SP1x2MM W	SP1x2MM W	N	N	0.3M DV
AS5738G-644G32Mn	EME A	Luxembourg	LX.PAM0X.038	AS5738G-644G32Mn VHP32ATLU3 MC N10MGE1512CbbM 2*2G/320/6L/5R/ CB_n2_0.3D_IT41	C2DT6400	NLED15.6WXGAG	N10MG E1	512M-DDR2(6 4*16*4)	SO2GBIII10	N320GB5.4KS	NSM8XS	SP1x2MM W	SP1x2MM W	N	N	0.3M DV
AS5738G-644G32Mn	EME A	Israel	LX.PAM0X.043	AS5738G-644G32Mn VHP32ATIL1 MC N10MGE1512CbbM 2*2G/320/6L/5R/ CB_n2_0.3D_HE12	C2DT6400	NLED15.6WXGAG	N10MG E1	512M-DDR2(6 4*16*4)	SO2GBIII10	N320GB5.4KS	NSM8XS	SP1x2MM W	SP1x2MM W	N	N	0.3M DV
AS5738G-644G32Mn	EME A	Czech	LX.PAM0X.028	AS5738G-644G32Mn VHP32ATCZ2 MC N10MGE1512CbbM 2*2G/320/6L/5R/ CB_n2_0.3D_SK12	C2DT6400	NLED15.6WXGAG	N10MG E1	512M-DDR2(6 4*16*4)	SO2GBIII10	N320GB5.4KS	NSM8XS	SP1x2MM W	SP1x2MM W	N	N	0.3M DV
AS5738G-644G32Mn	EME A	Portugal	LX.PAM0X.021	AS5738G-644G32Mn VHP32ATPT1 MC N10MGE1512CbbM 2*2G/320/6L/5R/ CB_n2_0.3D_PT12	C2DT6400	NLED15.6WXGAG	N10MG E1	512M-DDR2(6 4*16*4)	SO2GBIII10	N320GB5.4KS	NSM8XS	SP1x2MM W	SP1x2MM W	N	N	0.3M DV
AS5738G-644G32Mn	EME A	Norway	LX.PAM0X.024	AS5738G-644G32Mn VHP32ATNO3 MC N10MGE1512CbbM 2*2G/320/6L/5R/ CB_n2_0.3D_ENS3	C2DT6400	NLED15.6WXGAG	N10MG E1	512M-DDR2(6 4*16*4)	SO2GBIII10	N320GB5.4KS	NSM8XS	SP1x2MM W	SP1x2MM W	N	N	0.3M DV
AS5738G-644G32Mn	EME A	Denmark	LX.PAM0X.034	AS5738G-644G32Mn VHP32ATDK2 MC N10MGE1512CbbM 2*2G/320/6L/5R/ CB_n2_0.3D_ENS3	C2DT6400	NLED15.6WXGAG	N10MG E1	512M-DDR2(6 4*16*4)	SO2GBIII10	N320GB5.4KS	NSM8XS	SP1x2MM W	SP1x2MM W	N	N	0.3M DV
AS5738G-644G32Mn	EME A	Finland	LX.PAM0X.022	AS5738G-644G32Mn VHP32ATFI2 MC N10MGE1512CbbM 2*2G/320/6L/5R/ CB_n2_0.3D_FI11	C2DT6400	NLED15.6WXGAG	N10MG E1	512M-DDR2(6 4*16*4)	SO2GBIII10	N320GB5.4KS	NSM8XS	SP1x2MM W	SP1x2MM W	N	N	0.3M DV
AS5738G-644G32Mn	EME A	Eastern Europe	LX.PAM0X.040	AS5738G-644G32Mn VHP32ATEU4 MC N10MGE1512CbbM 2*2G/320/6L/5R/ CB_n2_0.3D_SV22	C2DT6400	NLED15.6WXGAG	N10MG E1	512M-DDR2(6 4*16*4)	SO2GBIII10	N320GB5.4KS	NSM8XS	SP1x2MM W	SP1x2MM W	N	N	0.3M DV
AS5738G-644G32Mn	EME A	Sweden	LX.PAM0X.027	AS5738G-644G32Mn VHP32ATSE1 MC N10MGE1512CbbM 2*2G/320/6L/5R/ CB_n2_0.3D_FI13	C2DT6400	NLED15.6WXGAG	N10MG E1	512M-DDR2(6 4*16*4)	SO2GBIII10	N320GB5.4KS	NSM8XS	SP1x2MM W	SP1x2MM W	N	N	0.3M DV
AS5738G-644G32Mn	EME A	Middle East	LX.PAM0X.045	AS5738G-644G32Mn EM VHP32ATME6 MC N10MGE1512CbbM 2*2G/320/6L/5R/ CB_n2_0.3D_EN15	C2DT6400	NLED15.6WXGAG	N10MG E1	512M-DDR2(6 4*16*4)	SO2GBIII10	N320GB5.4KS	NSM8XS	SP1x2MM W	SP1x2MM W	N	N	0.3M DV
AS5738G-644G32Mn	EME A	Eastern Europe	LX.PAM0X.032	AS5738G-644G32Mn VHP32ATEU5 MC N10MGE1512CbbM 2*2G/320/6L/5R/ CB_n2_0.3D_PL13	C2DT6400	NLED15.6WXGAG	N10MG E1	512M-DDR2(6 4*16*4)	SO2GBIII10	N320GB5.4KS	NSM8XS	SP1x2MM W	SP1x2MM W	N	N	0.3M DV
AS5738G-644G32Mn	EME A	Holland	LX.PAM0X.037	AS5738G-644G32Mn VHP32ATNL1 MC N10MGE1512CbbM 2*2G/320/6L/5R/ CB_n2_0.3D_NL12	C2DT6400	NLED15.6WXGAG	N10MG E1	512M-DDR2(6 4*16*4)	SO2GBIII10	N320GB5.4KS	NSM8XS	SP1x2MM W	SP1x2MM W	N	N	0.3M DV
AS5738G-644G32Mn	EME A	South Africa	LX.PAM0X.048	AS5738G-644G32Mn EM VHP32ATZA2 MC N10MGE1512CbbM 2*2G/320/6L/5R/ CB_n2_0.3D_EN16	C2DT6400	NLED15.6WXGAG	N10MG E1	512M-DDR2(6 4*16*4)	SO2GBIII10	N320GB5.4KS	NSM8XS	SP1x2MM W	SP1x2MM W	N	N	0.3M DV
AS5738G-644G32Mn	EME A	Eastern Europe	LX.PAM0X.023	AS5738G-644G32Mn VHP32ATEU3 MC N10MGE1512CbbM 2*2G/320/6L/5R/ CB_n2_0.3D_RU23	C2DT6400	NLED15.6WXGAG	N10MG E1	512M-DDR2(6 4*16*4)	SO2GBIII10	N320GB5.4KS	NSM8XS	SP1x2MM W	SP1x2MM W	N	N	0.3M DV
AS5738G-644G32Mn	EME A	Ukraine	LX.PAM0X.014	AS5738G-644G32Mn VHP32ATUK1 MC N10MGE1512CbbM 2*2G/320/6L/5R/ CB_n2_0.3D_RU11	C2DT6400	NLED15.6WXGAG	N10MG E1	512M-DDR2(6 4*16*4)	SO2GBIII10	N320GB5.4KS	NSM8XS	SP1x2MM W	SP1x2MM W	N	N	0.3M DV

Model	RO	Country	Acer Part No	Description	CPU	LCD	VGA Chip	VRAM 1	Memory 1/ Memory 2	HDD 1(GB)	ODD	WLAN	WLAN1	Bluetooth	Finger- print	Camera
AS5738G-644G32Mn	EME A	Turkey	LX.PAM0X.011	AS5738G-644G32Mn EM VHP32ATTR1 MC N10MGE1512CbbM 2*2G/320/6L/5R/ CB_n2_0.3D_TR33	C2DT6400	NLED15.6WXGAG	N10MG E1	512M-DDR2(6 4*16*4)	SO2GBIII10	N320GB5.4KS	NSM8XS	SP1x2MM W	SP1x2MM W	N	N	0.3M DV
AS5738G-644G32Mn	EME A	UK	LX.PAM0X.010	AS5738G-644G32Mn VHP32ATGB1 MC N10MGE1512CbbM 2*2G/320/6L/5R/ CB_n2_0.3D_EN14	C2DT6400	NLED15.6WXGAG	N10MG E1	512M-DDR2(6 4*16*4)	SO2GBIII10	N320GB5.4KS	NSM8XS	SP1x2MM W	SP1x2MM W	N	N	0.3M DV
AS5738G-644G32Mn	EME A	Poland	LX.PAM0X.012	AS5738G-644G32Mn VHP32ATPL1 MC N10MGE1512CbbM 2*2G/320/6L/5R/ CB_n2_0.3D_PL11	C2DT6400	NLED15.6WXGAG	N10MG E1	512M-DDR2(6 4*16*4)	SO2GBIII10	N320GB5.4KS	NSM8XS	SP1x2MM W	SP1x2MM W	N	N	0.3M DV
AS5738G-644G32Mn	EME A	Switzerland	LX.PAM0X.013	AS5738G-644G32Mn VHP32ATCH1 MC N10MGE1512CbbM 2*2G/320/6L/5R/ CB_n2_0.3D_IT42	C2DT6400	NLED15.6WXGAG	N10MG E1	512M-DDR2(6 4*16*4)	SO2GBIII10	N320GB5.4KS	NSM8XS	SP1x2MM W	SP1x2MM W	N	N	0.3M DV
AS5738G-644G32Mn	EME A	France	LX.PAM0X.008	AS5738G-644G32Mn VHP32ATFR1 MC N10MGE1512CbbM 2*2G/320/6L/5R/ CB_n2_0.3D_FR23	C2DT6400	NLED15.6WXGAG	N10MG E1	512M-DDR2(6 4*16*4)	SO2GBIII10	N320GB5.4KS	NSM8XS	SP1x2MM W	SP1x2MM W	N	N	0.3M DV
AS5738G-643G32Mn	EME A	UK	LX.PAM0X.007	AS5738G-643G32Mn VHP32ATGB1 MC N10MGE1512CbbM 2G+1G/320/6L/5R/ CB_n2_0.3D_EN14	C2DT6400	NLED15.6WXGAG	N10MG E1	512M-DDR2(6 4*16*4)	SO2GBIII10	N320GB5.4KS	NSM8XS	SP1x2MM W	SP1x2MM W	N	N	0.3M DV
AS5738G-643G32Mn	EME A	Middle East	LX.PAM0X.009	AS5738G-643G32Mn EM VHP32ATME2 MC N10MGE1512CbbM 2G+1G/320/6L/5R/ CB_n2_0.3D_AR23	C2DT6400	NLED15.6WXGAG	N10MG E1	512M-DDR2(6 4*16*4)	SO2GBIII10	N320GB5.4KS	NSM8XS	SP1x2MM W	SP1x2MM W	BT 2.0	N	0.3M DV
AS5738G-644G32Bn	EME A	UK	LX.PAM0X.006	AS5738G-644G32Bn VHP32ATGB1 MC N10MGE1512CbbM 2*2G/320/6L/5R/ CB_n2_0.3D_EN14	C2DT6400	NLED15.6WXGAG	N10MG E1	512M-DDR2(6 4*16*4)	SO2GBIII10	N320GB5.4KS	NBDCB4 XS	SP1x2MM W	SP1x2MM W	N	N	0.3M DV
AS5738G-644G32Bn	PA	USA	LX.PAM0X.004	AS5738G-644G32Bn VHP32ATUS1 MC N10MGE1512CbbM 2*2G/320/6L/ CB_n2_0.3D_EN33	C2DT6400	NLED15.6WXGAG	N10MG E1	512M-DDR2(6 4*16*4)	SO2GBIII10	N320GB5.4KS	NBDCB4 XS	SP1x2MM W	SP1x2MM W	N	N	0.3M DV
AS5738G-644G32Bn	PA	USA	LX.PAM0X.001	AS5738G-644G32Bn VHP32ATUS1 MC N10MGE1512CbbM 2*2G/320/6L/ CB_n2_0.3D_EN35	C2DT6400	NLED15.6WXGAG	N10MG E1	512M-DDR2(6 4*16*4)	SO2GBIII10	N320GB5.4KS	NBDCB4 XS	SP1x2MM W	SP1x2MM W	N	N	0.3M DV
AS5738G-644G32Bn	PA	USA	LX.PAM0X.002	AS5738G-644G32Bn VHP32ATUS1 MC N10MGE1512CbbM 2*2G/320/6L/ CB_n2_0.3D_EN34	C2DT6400	NLED15.6WXGAG	N10MG E1	512M-DDR2(6 4*16*4)	SO2GBIII10	N320GB5.4KS	NBDCB4 XS	SP1x2MM W	SP1x2MM W	N	N	0.3M DV
AS5738G-644G32Bn	PA	Canada	LX.PAM0X.003	AS5738G-644G32Bn VHP32ATCA2 MC N10MGE1512CbbM 2*2G/320/6L/ CB_n2_0.3D_FR34	C2DT6400	NLED15.6WXGAG	N10MG E1	512M-DDR2(6 4*16*4)	SO2GBIII10	N320GB5.4KS	NBDCB4 XS	SP1x2MM W	SP1x2MM W	N	N	0.3M DV
AS5738G-644G50B	WW	WW	S2.PB20Y.002	AS5738G-644G50B/VHB32AWW1 MC N10MGE1512GCF 2*2G/500_L/6L/ CB_FP_0.3D_3G_GG7_EN11	C2DT6400	N15.6WXGAG	N10MG E1	512M-DDR2(6 4*16*4)	SO2GBIII10	N500GB5.4KS	NBDCB4 XS	N	N	N	AES1610	0.3M DV
AS5738G-644G50B	WW	GCTWN	S2.PB20Y.001	AS5738G-644G50B/VHB32AWW1 MC N10MGE1512GCF 2*2G/500_L/6L/ CB_FP_0.3D_3G_GG7_ENX1	C2DT6400	N15.6WXGAG	N10MG E1	512M-DDR2(6 4*16*4)	SO2GBIII10	N500GB5.4KS	NBDCB4 XS	N	N	N	AES1610	0.3M DV
AS5738G-664G32Mn	EME A	UK	LX.PAL0X.001	AS5738G-664G32Mn VHP32ATGB1 MC N10MGE1512bbM 2*2G/320/6L/5R/ CB_n2_EN14	C2DT6600	NLED15.6WXGAG	N10MG E1	512M-DDR2(6 4*16*4)	SO2GBIII10	N320GB5.4KS	NSM8XS	SP1x2MM W	SP1x2MM W	N	N	N
AS5738G-643G32Mn	EME A	UK	LX.PAL0X.002	AS5738G-643G32Mn VHP32ATGB1 MC N10MGE1512bbM 2G+1G/320/6L/5R/ CB_n2_EN14	C2DT6400	NLED15.6WXGAG	N10MG E1	512M-DDR2(6 4*16*4)	SO2GBIII10	N320GB5.4KS	NSM8XS	SP1x2MM W	SP1x2MM W	N	N	N
AS5738ZG-424G50Mi	EME A	Ukraine	LX.PAU0C.002	AS5738ZG-424G50Mi LINPUSAUK1 N10MGE1512CFbb 2*2G/500_L/6L/5R/ CB_bg_FP_0.3D_EN71	PMDT4200	NLED15.6WXGAG	N10MG E1	512M-DDR2(6 4*16*4)	SO2GBIII10	N500GB5.4KS	NSM8XS	3rd WiFi 1x2 BGN	3rd WiFi BG	BT 2.0	AES1610	0.3M DV
AS5738ZG-422G32Mn	AAP	Vietnam	LX.PAU0C.001	AS5738ZG-422G32Mn LINPUSAVN1 N10MGE1512CFbb 1*2G/320/6L/5R/ CB_bgn_FP_0.3D_EN11	PMDT4200	NLED15.6WXGAG	N10MG E1	512M-DDR2(6 4*16*4)	SO2GBIII10/N	N320GB5.4KS	NSM8XS	3rd WiFi 1x2 BGN	3rd WiFi 1x2 BGN	BT 2.0	AES1610	0.3M DV

Model	RO	Country	Acer Part No	Description	CPU	LCD	VGA Chip	VRAM 1	Memory 1/ Memory 2	HDD 1(GB)	ODD	WLAN	WLAN1	Bluetooth	Finger- print	Camera
AS5738ZG - 423G32Mn	AAP	Australia/ New Zealand	LX.PAU0X.003	AS5738ZG-423G32Mn VHP32ATAU1 MC N10MGE1512CFbb 2G+1G/320/BT/6L/ CB_bgn_FP_0.3D_EN12	PMDT420 0	NLED15.6WXGAG	N10MG E1	512M- DDR2(6 4*16*4)	SO2GBIII10	N320GB5.4KS	NSM8XS	3rd WiFi 1x2 BGN	3rd WiFi 1x2 BGN	BT 2.0	AES161 0	0.3M DV
AS5738ZG - 424G50Mn	AAP	Australia/ New Zealand	LX.PAU0X.001	AS5738ZG-424G50Mn VHP32ATAU1 MC N10MGE1512CFbb 2*2G/500_L/BT/6L/ CB_bgn_FP_0.3D_EN12	PMDT420 0	NLED15.6WXGAG	N10MG E1	512M- DDR2(6 4*16*4)	SO2GBIII10	N500GB5.4KS	NSM8XS	3rd WiFi 1x2 BGN	3rd WiFi 1x2 BGN	BT 2.0	AES161 0	0.3M DV
AS5738ZG - 423G50Mn	AAP	Australia/ New Zealand	LX.PAU0X.002	AS5738ZG-423G50Mn VHP32ATAU1 MC N10MGE1512CFbb 2G+1G/500_L/BT/6L/ CB_bgn_FP_0.3D_EN12	PMDT420 0	NLED15.6WXGAG	N10MG E1	512M- DDR2(6 4*16*4)	SO2GBIII10	N500GB5.4KS	NSM8XS	3rd WiFi 1x2 BGN	3rd WiFi 1x2 BGN	BT 2.0	AES161 0	0.3M DV
AS5738ZG - 422G32Mn	TW N	GCTWN	LX.PAU0Y.001	AS5738ZG-422G32Mn VHB32ATTW1 MC N10MGE1512CFbb 1*2G/320/BT/6L/ CB_bgn_FP_0.3D_TC11	PMDT420 0	NLED15.6WXGAG	N10MG E1	512M- DDR2(6 4*16*4)	SO2GBIII10/N	N320GB5.4KS	NSM8XS	3rd WiFi 1x2 BGN	3rd WiFi 1x2 BGN	BT 2.0	AES161 0	0.3M DV
AS5738ZG - 422G32Mn	AAP	Australia/ New Zealand	LX.PAU0X.004	AS5738ZG-422G32Mn VHP32ATAU1 MC N10MGE1512CFbb 1*2G/320/BT/6L/ CB_bgn_FP_0.3D_EN12	PMDT420 0	NLED15.6WXGAG	N10MG E1	512M- DDR2(6 4*16*4)	SO2GBIII10/N	N320GB5.4KS	NSM8XS	3rd WiFi 1x2 BGN	3rd WiFi 1x2 BGN	BT 2.0	AES161 0	0.3M DV
AS5738ZG - 423G32Mn	WW	GCTWN	S2.PAU0X.001	AS5738ZG-423G32Mn VHP32AWW1 MC N10MGE1512CFbb 2G+1G/320/BT/6L/ CB_bgn_FP_0.3D_ENX1	PMDT420 0	N15.6WXGAG	N10MG E1	512M- DDR2(6 4*16*4)	SO2GBIII10	N320GB5.4KS	NSM8XS	3rd WiFi 1x2 BGN	3rd WiFi 1x2 BGN	BT 2.0	AES161 0	0.3M DV
AS5738ZG - 423G32Mn	WW	WW	S2.PAU0X.002	AS5738ZG-423G32Mn VHP32AWW1 MC N10MGE1512CFbb 2G+1G/320/BT/6L/ CB_bgn_FP_0.3D_EN11	PMDT420 0	N15.6WXGAG	N10MG E1	512M- DDR2(6 4*16*4)	SO2GBIII10	N320GB5.4KS	NSM8XS	3rd WiFi 1x2 BGN	3rd WiFi 1x2 BGN	BT 2.0	AES161 0	0.3M DV
AS5738ZG - 422G25Mn	AAP	Australia/ New Zealand	LX.PAU0X.005	AS5738ZG-422G25Mn VHP32ATAU1 MC N10MGE1512CFbb 1*2G/250/BT/6L/ CB_bgn_FP_0.3D_EN12	PMDT420 0	NLED15.6WXGAG	N10MG E1	512M- DDR2(6 4*16*4)	SO2GBIII10/N	N250GB5.4KS	NSM8XS	3rd WiFi 1x2 BGN	3rd WiFi 1x2 BGN	BT 2.0	AES161 0	0.3M DV
AS5738ZG - 422G16Mn	EME A	Poland	LX.PAT0X.088	AS5738ZG-422G16Mn VHP32ATPL1 MC N10MGE1512Cbb 1*2G/160/6L/5R/ CB_bgn_0.3D_PL11	PMDT420 0	NLED15.6WXGAG	N10MG E1	512M- DDR2(6 4*16*4)	SO2GBIII10/N	N160GB5.4KS	NSM8XS	3rd WiFi 1x2 BGN	3rd WiFi 1x2 BGN	N	N	0.3M DV
AS5738ZG - 423G32Mn	EME A	Poland	LX.PAT0X.086	AS5738ZG-423G32Mn VHP32ATPL1 MC N10MGE1512Cbb 2G+1G/320/6L/5R/ CB_bgn_0.3D_PL11	PMDT420 0	NLED15.6WXGAG	N10MG E1	512M- DDR2(6 4*16*4)	SO2GBIII10	N320GB5.4KS	NSM8XS	3rd WiFi 1x2 BGN	3rd WiFi 1x2 BGN	N	N	0.3M DV
AS5738ZG - 424G50Mn	EME A	Denmark	LX.PAT0X.089	AS5738ZG-424G50Mn VHP32ATDK2 MC N10MGE1512Cbb 2G+1G/500_L/BT/6L/5R/ CB_bgn_0.3D_ENS3	PMDT420 0	NLED15.6WXGAG	N10MG E1	512M- DDR2(6 4*16*4)	SO2GBIII10	N500GB5.4KS	NSM8XS	3rd WiFi 1x2 BGN	3rd WiFi 1x2 BGN	BT 2.0	N	0.3M DV
AS5738ZG - 422G25Mn	EME A	Poland	LX.PAT0X.087	AS5738ZG-422G25Mn VHP32ATPL1 MC N10MGE1512Cbb 1*2G/250/6L/5R/ CB_bgn_0.3D_PL11	PMDT420 0	NLED15.6WXGAG	N10MG E1	512M- DDR2(6 4*16*4)	SO2GBIII10/N	N250GB5.4KS	NSM8XS	3rd WiFi 1x2 BGN	3rd WiFi 1x2 BGN	N	N	0.3M DV
AS5738ZG - 422G25Mn	AAP	Vietnam	LX.PAT0C.005	AS5738ZG-422G25Mn LINPUSAVN1 N10MGE1512Cbb 1*2G/250/BT/6L/5R/ CB_bgn_0.3D_EN11	PMDT420 0	NLED15.6WXGAG	N10MG E1	512M- DDR2(6 4*16*4)	SO2GBIII10/N	N250GB5.4KS	NSM8XS	3rd WiFi 1x2 BGN	3rd WiFi 1x2 BGN	BT 2.0	N	0.3M DV
AS5738ZG - 424G32Mn	EME A	Denmark	LX.PAT0X.085	AS5738ZG-424G32Mn VHP32ATDK2 MC N10MGE1512Cbb 2*2G/320/BT/6L/5R/ CB_bgn_0.3D_ENS3	PMDT420 0	NLED15.6WXGAG	N10MG E1	512M- DDR2(6 4*16*4)	SO2GBIII10	N320GB5.4KS	NSM8XS	3rd WiFi 1x2 BGN	3rd WiFi 1x2 BGN	BT 2.0	N	0.3M DV
AS5738ZG - 423G32Mn	EME A	Middle East	LX.PAT0C.003	AS5738ZG-423G32Mn LINPUSAME4 N10MGE1512Cbb 2G+1G/320/BT/6L/5R/ CB_bgn_0.3D_EN72	PMDT420 0	NLED15.6WXGAG	N10MG E1	512M- DDR2(6 4*16*4)	SO2GBIII10	N320GB5.4KS	NSM8XS	3rd WiFi 1x2 BGN	3rd WiFi 1x2 BGN	BT 2.0	N	0.3M DV
AS5738ZG - 423G25Mn	EME A	Eastern Europe	LX.PAT0C.004	AS5738ZG-423G25Mn LINPUSAEU7 N10MGE1512Cbb 2G+1G/250/BT/6L/5R/ CB_bgn_0.3D_EN11	PMDT420 0	NLED15.6WXGAG	N10MG E1	512M- DDR2(6 4*16*4)	SO2GBIII10	N250GB5.4KS	NSM8XS	3rd WiFi 1x2 BGN	3rd WiFi 1x2 BGN	BT 2.0	N	0.3M DV
AS5738ZG - 424G25Mn	EME A	France	LX.PAT0X.084	AS5738ZG-424G25Mn VHP32ATFR1 MC N10MGE1512Cbb 2*2G/250/6L/5R/ CB_bgn_0.3D_FR23	PMDT420 0	NLED15.6WXGAG	N10MG E1	512M- DDR2(6 4*16*4)	SO2GBIII10	N250GB5.4KS	NSM8XS	3rd WiFi 1x2 BGN	3rd WiFi 1x2 BGN	N	N	0.3M DV
AS5738ZG - 423G25Bn	EME A	UK	LX.PAT0X.083	AS5738ZG-423G25Bn VHP32ATGB1 MC N10MGE1512Cbb 2G+1G/250/6L/5R/ CB_bgn_0.3D_EN14	PMDT420 0	NLED15.6WXGAG	N10MG E1	512M- DDR2(6 4*16*4)	SO2GBIII10	N250GB5.4KS	NBDCB4 XS	3rd WiFi 1x2 BGN	3rd WiFi 1x2 BGN	N	N	0.3M DV

Model	RO	Country	Acer Part No	Description	CPU	LCD	VGA Chip	VRAM 1	Memory 1/ Memory 2	HDD 1(GB)	ODD	WLAN	WLAN1	Bluetooth	Finger- print	Camera
AS5738ZG - 424G32Mn	EME A	Poland	LX.PAT0X.059	AS5738ZG-424G32Mn VHP32ATPL1 MC N10MGE1512Cbb 2*2G/320/6L/ CB_bgn_0.3D_PL11	PMDT420 0	NLED15.6WXGAG	N10MG E1	512M- DDR2(6 4*16*4)	SO2GBIII10	N320GB5.4KS	NSM8XS	3rd WiFi 1x2 BGN	3rd WiFi 1x2 BGN	N	N	0.3M DV
AS5738ZG - 424G32Mn	EME A	Turkey	LX.PAT0X.058	AS5738ZG-424G32Mn EM VHP32ATTR1 MC N10MGE1512Cbb 2*2G/320/6L/ CB_bgn_0.3D_TR33	PMDT420 0	NLED15.6WXGAG	N10MG E1	512M- DDR2(6 4*16*4)	SO2GBIII10	N320GB5.4KS	NSM8XS	3rd WiFi 1x2 BGN	3rd WiFi 1x2 BGN	N	N	0.3M DV
AS5738ZG - 424G32Mn	EME A	Middle East	LX.PAT0X.051	AS5738ZG-424G32Mn EM VHP32ATME9 MC N10MGE1512Cbb 2*2G/320/6L/ CB_bgn_0.3D_FR22	PMDT420 0	NLED15.6WXGAG	N10MG E1	512M- DDR2(6 4*16*4)	SO2GBIII10	N320GB5.4KS	NSM8XS	3rd WiFi 1x2 BGN	3rd WiFi 1x2 BGN	N	N	0.3M DV
AS5738ZG - 424G32Mn	EME A	Israel	LX.PAT0X.067	AS5738ZG-424G32Mn VHP32ATIL1 MC N10MGE1512Cbb 2*2G/320/6L/ CB_bgn_0.3D_HE12	PMDT420 0	NLED15.6WXGAG	N10MG E1	512M- DDR2(6 4*16*4)	SO2GBIII10	N320GB5.4KS	NSM8XS	3rd WiFi 1x2 BGN	3rd WiFi 1x2 BGN	N	N	0.3M DV
AS5738ZG - 424G32Mn	EME A	Middle East	LX.PAT0X.055	AS5738ZG-424G32Mn EM VHP32ATME2 MC N10MGE1512Cbb 2*2G/320/6L/ CB_bgn_0.3D_AR13	PMDT420 0	NLED15.6WXGAG	N10MG E1	512M- DDR2(6 4*16*4)	SO2GBIII10	N320GB5.4KS	NSM8XS	3rd WiFi 1x2 BGN	3rd WiFi 1x2 BGN	N	N	0.3M DV
AS5738ZG - 424G32Mn	EME A	Germany	LX.PAT0X.066	AS5738ZG-424G32Mn VHP32ATDE1 MC N10MGE1512Cbb 2*2G/320/6L/ CB_bgn_0.3D_DE13	PMDT420 0	NLED15.6WXGAG	N10MG E1	512M- DDR2(6 4*16*4)	SO2GBIII10	N320GB5.4KS	NSM8XS	3rd WiFi 1x2 BGN	3rd WiFi 1x2 BGN	N	N	0.3M DV
AS5738ZG - 424G32Mn	EME A	Middle East	LX.PAT0X.056	AS5738ZG-424G32Mn EM VHP32ATME3 MC N10MGE1512Cbb 2*2G/320/6L/ CB_bgn_0.3D_FR23	PMDT420 0	NLED15.6WXGAG	N10MG E1	512M- DDR2(6 4*16*4)	SO2GBIII10	N320GB5.4KS	NSM8XS	3rd WiFi 1x2 BGN	3rd WiFi 1x2 BGN	N	N	0.3M DV
AS5738ZG - 424G32Mn	EME A	Italy	LX.PAT0X.072	AS5738ZG-424G32Mn VHP32ATIT1 MC N10MGE1512Cbb 2*2G/320/6L/ CB_bgn_0.3D_IT12	PMDT420 0	NLED15.6WXGAG	N10MG E1	512M- DDR2(6 4*16*4)	SO2GBIII10	N320GB5.4KS	NSM8XS	3rd WiFi 1x2 BGN	3rd WiFi 1x2 BGN	N	N	0.3M DV
AS5738ZG - 424G32Mn	EME A	France	LX.PAT0X.065	AS5738ZG-424G32Mn VHP32ATFR1 MC N10MGE1512Cbb 2*2G/320/6L/ CB_bgn_0.3D_FR23	PMDT420 0	NLED15.6WXGAG	N10MG E1	512M- DDR2(6 4*16*4)	SO2GBIII10	N320GB5.4KS	NSM8XS	3rd WiFi 1x2 BGN	3rd WiFi 1x2 BGN	N	N	0.3M DV
AS5738ZG - 424G32Mn	EME A	Middle East	LX.PAT0X.054	AS5738ZG-424G32Mn EM VHP32ATME4 MC N10MGE1512Cbb 2*2G/320/6L/ CB_bgn_0.3D_EN11	PMDT420 0	NLED15.6WXGAG	N10MG E1	512M- DDR2(6 4*16*4)	SO2GBIII10	N320GB5.4KS	NSM8XS	3rd WiFi 1x2 BGN	3rd WiFi 1x2 BGN	N	N	0.3M DV
AS5738ZG - 424G32Mn	EME A	Middle East	LX.PAT0X.057	AS5738ZG-424G32Mn EM VHP32ATME2 MC N10MGE1512Cbb 2*2G/320/6L/ CB_bgn_0.3D_AR23	PMDT420 0	NLED15.6WXGAG	N10MG E1	512M- DDR2(6 4*16*4)	SO2GBIII10	N320GB5.4KS	NSM8XS	3rd WiFi 1x2 BGN	3rd WiFi 1x2 BGN	N	N	0.3M DV
AS5738ZG - 424G32Mn	EME A	Middle East	LX.PAT0X.053	AS5738ZG-424G32Mn EM VHP32ATME2 MC N10MGE1512Cbb 2*2G/320/6L/ CB_bgn_0.3D_EN15	PMDT420 0	NLED15.6WXGAG	N10MG E1	512M- DDR2(6 4*16*4)	SO2GBIII10	N320GB5.4KS	NSM8XS	3rd WiFi 1x2 BGN	3rd WiFi 1x2 BGN	N	N	0.3M DV
AS5738ZG - 424G32Mn	EME A	Middle East	LX.PAT0X.052	AS5738ZG-424G32Mn EM VHP32ATME6 MC N10MGE1512Cbb 2*2G/320/6L/ CB_bgn_0.3D_EN15	PMDT420 0	NLED15.6WXGAG	N10MG E1	512M- DDR2(6 4*16*4)	SO2GBIII10	N320GB5.4KS	NSM8XS	3rd WiFi 1x2 BGN	3rd WiFi 1x2 BGN	N	N	0.3M DV
AS5738ZG - 424G32Mn	EME A	South Africa	LX.PAT0X.061	AS5738ZG-424G32Mn EM VHP32ATZA2 MC N10MGE1512Cbb 2*2G/320/6L/ CB_bgn_0.3D_EN16	PMDT420 0	NLED15.6WXGAG	N10MG E1	512M- DDR2(6 4*16*4)	SO2GBIII10	N320GB5.4KS	NSM8XS	3rd WiFi 1x2 BGN	3rd WiFi 1x2 BGN	N	N	0.3M DV
AS5738ZG - 424G32Mn	EME A	Portugal	LX.PAT0X.073	AS5738ZG-424G32Mn VHP32ATPT1 MC N10MGE1512Cbb 2*2G/320/6L/ CB_bgn_0.3D_PT12	PMDT420 0	NLED15.6WXGAG	N10MG E1	512M- DDR2(6 4*16*4)	SO2GBIII10	N320GB5.4KS	NSM8XS	3rd WiFi 1x2 BGN	3rd WiFi 1x2 BGN	N	N	0.3M DV
AS5738ZG - 423G25Mn	EME A	UK	LX.PAT0X.001	AS5738ZG-423G25Mn VHP32ATGB1 MC N10MGE1512Cbb 2G+1G/250/6L/ CB_bgn_0.3D_EN14	PMDT420 0	NLED15.6WXGAG	N10MG E1	512M- DDR2(6 4*16*4)	SO2GBIII10	N250GB5.4KS	NSM8XS	3rd WiFi 1x2 BGN	3rd WiFi 1x2 BGN	N	N	0.3M DV
AS5738ZG - 424G32Mn	EME A	Greece	LX.PAT0X.060	AS5738ZG-424G32Mn VHP32ATGR1 MC N10MGE1512Cbb 2*2G/320/6L/ CB_bgn_0.3D_EL32	PMDT420 0	NLED15.6WXGAG	N10MG E1	512M- DDR2(6 4*16*4)	SO2GBIII10	N320GB5.4KS	NSM8XS	3rd WiFi 1x2 BGN	3rd WiFi 1x2 BGN	N	N	0.3M DV
AS5738ZG - 424G32Mn	EME A	Denmark	LX.PAT0X.064	AS5738ZG-424G32Mn VHP32ATDK2 MC N10MGE1512Cbb 2*2G/320/6L/ CB_bgn_0.3D_ENS3	PMDT420 0	NLED15.6WXGAG	N10MG E1	512M- DDR2(6 4*16*4)	SO2GBIII10	N320GB5.4KS	NSM8XS	3rd WiFi 1x2 BGN	3rd WiFi 1x2 BGN	N	N	0.3M DV

Model	RO	Country	Acer Part No	Description	CPU	LCD	VGA Chip	VRAM 1	Memory 1/ Memory 2	HDD 1(GB)	ODD	WLAN	WLAN1	Bluetooth	Finger- print	Camera
AS5738ZG - 424G32Mn	EME A	South Africa	LX.PAT0X.062	AS5738ZG-424G32Mn EM VHP32ATZA1 MC N10MGE1512Cbb 2*2G/320/6L/ CB_bgn_0.3D_FR23	PMDT420 0	NLED15.6WXGAG	N10MG E1	512M- DDR2(6 4*16*4)	SO2GBIII10	N320GB5.4KS	NSM8XS	3rd WiFi 1x2 BGN	3rd WiFi 1x2 BGN	N	N	0.3M DV
AS5738ZG - 424G32Mn	EME A	Eastern Europe	LX.PAT0X.075	AS5738ZG-424G32Mn VHP32ATEU3 MC N10MGE1512Cbb 2*2G/320/6L/ CB_bgn_0.3D_RU23	PMDT420 0	NLED15.6WXGAG	N10MG E1	512M- DDR2(6 4*16*4)	SO2GBIII10	N320GB5.4KS	NSM8XS	3rd WiFi 1x2 BGN	3rd WiFi 1x2 BGN	N	N	0.3M DV
AS5738ZG - 423G25Mi	EME A	Ukraine	LX.PAT0X.002	AS5738ZG-423G25Mi VHP32ATUK1 MC N10MGE1512Cbb 2G+1G/250/6L/ CB_bg_0.3D_RU11	PMDT420 0	NLED15.6WXGAG	N10MG E1	512M- DDR2(6 4*16*4)	SO2GBIII10	N250GB5.4KS	NSM8XS	3rd WiFi 1x2 BGN	3rd WiFi BG	N	N	0.3M DV
AS5738ZG - 424G32Mn	EME A	Hungary	LX.PAT0X.077	AS5738ZG-424G32Mn VHP32ATHU1 MC N10MGE1512Cbb 2*2G/320/6L/ CB_bgn_0.3D_HU13	PMDT420 0	NLED15.6WXGAG	N10MG E1	512M- DDR2(6 4*16*4)	SO2GBIII10	N320GB5.4KS	NSM8XS	3rd WiFi 1x2 BGN	3rd WiFi 1x2 BGN	N	N	0.3M DV
AS5738ZG - 424G32Mn	EME A	Finland	LX.PAT0X.074	AS5738ZG-424G32Mn VHP32ATFI1 MC N10MGE1512Cbb 2*2G/320/6L/ CB_bgn_0.3D_FI11	PMDT420 0	NLED15.6WXGAG	N10MG E1	512M- DDR2(6 4*16*4)	SO2GBIII10	N320GB5.4KS	NSM8XS	3rd WiFi 1x2 BGN	3rd WiFi 1x2 BGN	N	N	0.3M DV
AS5738ZG - 424G32Mn	EME A	Eastern Europe	LX.PAT0X.076	AS5738ZG-424G32Mn VHP32ATEU4 MC N10MGE1512Cbb 2*2G/320/6L/ CB_bgn_0.3D_SV22	PMDT420 0	NLED15.6WXGAG	N10MG E1	512M- DDR2(6 4*16*4)	SO2GBIII10	N320GB5.4KS	NSM8XS	3rd WiFi 1x2 BGN	3rd WiFi 1x2 BGN	N	N	0.3M DV
AS5738ZG - 424G32Mn	EME A	Denmark	LX.PAT0X.063	AS5738ZG-424G32Mn VHP32ATDK1 MC N10MGE1512Cbb 2*2G/320/6L/ CB_bgn_0.3D_NO13	PMDT420 0	NLED15.6WXGAG	N10MG E1	512M- DDR2(6 4*16*4)	SO2GBIII10	N320GB5.4KS	NSM8XS	3rd WiFi 1x2 BGN	3rd WiFi 1x2 BGN	N	N	0.3M DV
AS5738ZG - 424G32Mn	EME A	Spain	LX.PAT0X.078	AS5738ZG-424G32Mn VHP32ATES1 MC N10MGE1512Cbb 2*2G/320/6L/ CB_bgn_0.3D_ES22	PMDT420 0	NLED15.6WXGAG	N10MG E1	512M- DDR2(6 4*16*4)	SO2GBIII10	N320GB5.4KS	NSM8XS	3rd WiFi 1x2 BGN	3rd WiFi 1x2 BGN	N	N	0.3M DV
AS5738ZG - 423G25Mn	EME A	Middle East	LX.PAT0X.012	AS5738ZG-423G25Mn EM VHP32ATME9 MC N10MGE1512Cbb 2G+1G/250/6L/ CB_bgn_0.3D_FR22	PMDT420 0	NLED15.6WXGAG	N10MG E1	512M- DDR2(6 4*16*4)	SO2GBIII10	N250GB5.4KS	NSM8XS	3rd WiFi 1x2 BGN	3rd WiFi 1x2 BGN	N	N	0.3M DV
AS5738ZG - 423G25Mn	EME A	Italy	LX.PAT0X.013	AS5738ZG-423G25Mn VHP32ATIT1 MC N10MGE1512Cbb 2G+1G/250/6L/ CB_bgn_0.3D_IT12	PMDT420 0	NLED15.6WXGAG	N10MG E1	512M- DDR2(6 4*16*4)	SO2GBIII10	N250GB5.4KS	NSM8XS	3rd WiFi 1x2 BGN	3rd WiFi 1x2 BGN	N	N	0.3M DV
AS5738ZG - 423G25Mn	EME A	Turkey	LX.PAT0X.005	AS5738ZG-423G25Mn EM VHP32ATTR1 MC N10MGE1512Cbb 2G+1G/250/6L/ CB_bgn_0.3D_TR33	PMDT420 0	NLED15.6WXGAG	N10MG E1	512M- DDR2(6 4*16*4)	SO2GBIII10	N250GB5.4KS	NSM8XS	3rd WiFi 1x2 BGN	3rd WiFi 1x2 BGN	N	N	0.3M DV
AS5738ZG - 423G25Mn	EME A	Switzerland	LX.PAT0X.003	AS5738ZG-423G25Mn VHP32ATCH1 MC N10MGE1512Cbb 2G+1G/250/6L/ CB_bgn_0.3D_IT42	PMDT420 0	NLED15.6WXGAG	N10MG E1	512M- DDR2(6 4*16*4)	SO2GBIII10	N250GB5.4KS	NSM8XS	3rd WiFi 1x2 BGN	3rd WiFi 1x2 BGN	N	N	0.3M DV
AS5738ZG - 423G25Mn	EME A	Middle East	LX.PAT0X.007	AS5738ZG-423G25Mn EM VHP32ATME3 MC N10MGE1512Cbb 2G+1G/250/6L/ CB_bgn_0.3D_FR23	PMDT420 0	NLED15.6WXGAG	N10MG E1	512M- DDR2(6 4*16*4)	SO2GBIII10	N250GB5.4KS	NSM8XS	3rd WiFi 1x2 BGN	3rd WiFi 1x2 BGN	N	N	0.3M DV
AS5738ZG - 423G25Mn	EME A	Middle East	LX.PAT0X.009	AS5738ZG-423G25Mn EM VHP32ATME4 MC N10MGE1512Cbb 2G+1G/250/6L/ CB_bgn_0.3D_EN11	PMDT420 0	NLED15.6WXGAG	N10MG E1	512M- DDR2(6 4*16*4)	SO2GBIII10	N250GB5.4KS	NSM8XS	3rd WiFi 1x2 BGN	3rd WiFi 1x2 BGN	N	N	0.3M DV
AS5738ZG - 423G25Mn	EME A	Israel	LX.PAT0X.014	AS5738ZG-423G25Mn VHP32ATIL1 MC N10MGE1512Cbb 2G+1G/250/6L/ CB_bgn_0.3D_HE12	PMDT420 0	NLED15.6WXGAG	N10MG E1	512M- DDR2(6 4*16*4)	SO2GBIII10	N250GB5.4KS	NSM8XS	3rd WiFi 1x2 BGN	3rd WiFi 1x2 BGN	N	N	0.3M DV
AS5738ZG - 423G25Mn	EME A	Middle East	LX.PAT0X.008	AS5738ZG-423G25Mn EM VHP32ATME2 MC N10MGE1512Cbb 2G+1G/250/6L/ CB_bgn_0.3D_AR13	PMDT420 0	NLED15.6WXGAG	N10MG E1	512M- DDR2(6 4*16*4)	SO2GBIII10	N250GB5.4KS	NSM8XS	3rd WiFi 1x2 BGN	3rd WiFi 1x2 BGN	N	N	0.3M DV
AS5738ZG - 423G25Mn	EME A	Middle East	LX.PAT0X.006	AS5738ZG-423G25Mn EM VHP32ATME2 MC N10MGE1512Cbb 2G+1G/250/6L/ CB_bgn_0.3D_AR23	PMDT420 0	NLED15.6WXGAG	N10MG E1	512M- DDR2(6 4*16*4)	SO2GBIII10	N250GB5.4KS	NSM8XS	3rd WiFi 1x2 BGN	3rd WiFi 1x2 BGN	N	N	0.3M DV
AS5738ZG - 423G25Mn	EME A	Middle East	LX.PAT0X.010	AS5738ZG-423G25Mn EM VHP32ATME2 MC N10MGE1512Cbb 2G+1G/250/6L/ CB_bgn_0.3D_EN15	PMDT420 0	NLED15.6WXGAG	N10MG E1	512M- DDR2(6 4*16*4)	SO2GBIII10	N250GB5.4KS	NSM8XS	3rd WiFi 1x2 BGN	3rd WiFi 1x2 BGN	N	N	0.3M DV

Model	RO	Country	Acer Part No	Description	CPU	LCD	VGA Chip	VRAM 1	Memory 1/ Memory 2	HDD 1(GB)	ODD	WLAN	WLAN1	Bluetooth	Finger- print	Camera
AS5738ZG - 423G25Mn	EME A	Poland	LX.PAT0X.004	AS5738ZG-423G25Mn VHP32ATPL1 MC N10MGE1512Cbb 2G+1G/250/6L/ CB_bgn_0.3D_PL11	PMDT420 0	NLED15.6WXGAG	N10MG E1	512M- DDR2(6 4*16*4)	SO2GBIII10	N250GB5.4KS	NSM8XS	3rd WiFi 1x2 BGN	3rd WiFi 1x2 BGN	N	N	0.3M DV
AS5738ZG - 423G25Mn	EME A	Middle East	LX.PAT0X.011	AS5738ZG-423G25Mn EM VHP32ATME6 MC N10MGE1512Cbb 2G+1G/250/6L/ CB_bgn_0.3D_EN15	PMDT420 0	NLED15.6WXGAG	N10MG E1	512M- DDR2(6 4*16*4)	SO2GBIII10	N250GB5.4KS	NSM8XS	3rd WiFi 1x2 BGN	3rd WiFi 1x2 BGN	N	N	0.3M DV
AS5738ZG - 423G25Mn	EME A	Eastern Europe	LX.PAT0X.024	AS5738ZG-423G25Mn VHP32ATEU5 MC N10MGE1512Cbb 2G+1G/250/6L/ CB_bgn_0.3D_RO12	PMDT420 0	NLED15.6WXGAG	N10MG E1	512M- DDR2(6 4*16*4)	SO2GBIII10	N250GB5.4KS	NSM8XS	3rd WiFi 1x2 BGN	3rd WiFi 1x2 BGN	N	N	0.3M DV
AS5738ZG - 423G25Mn	EME A	Greece	LX.PAT0X.015	AS5738ZG-423G25Mn VHP32ATGR1 MC N10MGE1512Cbb 2G+1G/250/6L/ CB_bgn_0.3D_EL32	PMDT420 0	NLED15.6WXGAG	N10MG E1	512M- DDR2(6 4*16*4)	SO2GBIII10	N250GB5.4KS	NSM8XS	3rd WiFi 1x2 BGN	3rd WiFi 1x2 BGN	N	N	0.3M DV
AS5738ZG - 423G25Mn	EME A	Eastern Europe	LX.PAT0X.023	AS5738ZG-423G25Mn VHP32ATEU7 MC N10MGE1512Cbb 2G+1G/250/6L/ CB_bgn_0.3D_ENR2	PMDT420 0	NLED15.6WXGAG	N10MG E1	512M- DDR2(6 4*16*4)	SO2GBIII10	N250GB5.4KS	NSM8XS	3rd WiFi 1x2 BGN	3rd WiFi 1x2 BGN	N	N	0.3M DV
AS5738ZG - 423G25Mn	EME A	Eastern Europe	LX.PAT0X.025	AS5738ZG-423G25Mn VHP32ATEU7 MC N10MGE1512Cbb 2G+1G/250/6L/ CB_bgn_0.3D_SL11	PMDT420 0	NLED15.6WXGAG	N10MG E1	512M- DDR2(6 4*16*4)	SO2GBIII10	N250GB5.4KS	NSM8XS	3rd WiFi 1x2 BGN	3rd WiFi 1x2 BGN	N	N	0.3M DV
AS5738ZG - 423G25Mn	EME A	Eastern Europe	LX.PAT0X.021	AS5738ZG-423G25Mn VHP32ATEU3 MC N10MGE1512Cbb 2G+1G/250/6L/ CB_bgn_0.3D_RU23	PMDT420 0	NLED15.6WXGAG	N10MG E1	512M- DDR2(6 4*16*4)	SO2GBIII10	N250GB5.4KS	NSM8XS	3rd WiFi 1x2 BGN	3rd WiFi 1x2 BGN	N	N	0.3M DV
AS5738ZG - 423G25Mn	EME A	Hungary	LX.PAT0X.018	AS5738ZG-423G25Mn VHP32ATHU1 MC N10MGE1512Cbb 2G+1G/250/6L/ CB_bgn_0.3D_HU13	PMDT420 0	NLED15.6WXGAG	N10MG E1	512M- DDR2(6 4*16*4)	SO2GBIII10	N250GB5.4KS	NSM8XS	3rd WiFi 1x2 BGN	3rd WiFi 1x2 BGN	N	N	0.3M DV
AS5738ZG - 423G25Mn	EME A	Finland	LX.PAT0X.019	AS5738ZG-423G25Mn VHP32ATFI2 MC N10MGE1512Cbb 2G+1G/250/6L/ CB_bgn_0.3D_FI11	PMDT420 0	NLED15.6WXGAG	N10MG E1	512M- DDR2(6 4*16*4)	SO2GBIII10	N250GB5.4KS	NSM8XS	3rd WiFi 1x2 BGN	3rd WiFi 1x2 BGN	N	N	0.3M DV
AS5738ZG - 423G25Mn	EME A	Eastern Europe	LX.PAT0X.020	AS5738ZG-423G25Mn VHP32ATEU4 MC N10MGE1512Cbb 2G+1G/250/6L/ CB_bgn_0.3D_SV22	PMDT420 0	NLED15.6WXGAG	N10MG E1	512M- DDR2(6 4*16*4)	SO2GBIII10	N250GB5.4KS	NSM8XS	3rd WiFi 1x2 BGN	3rd WiFi 1x2 BGN	N	N	0.3M DV
AS5738ZG - 423G25Mn	EME A	Portugal	LX.PAT0X.017	AS5738ZG-423G25Mn VHP32ATPT1 MC N10MGE1512Cbb 2G+1G/250/6L/ CB_bgn_0.3D_PT12	PMDT420 0	NLED15.6WXGAG	N10MG E1	512M- DDR2(6 4*16*4)	SO2GBIII10	N250GB5.4KS	NSM8XS	3rd WiFi 1x2 BGN	3rd WiFi 1x2 BGN	N	N	0.3M DV
AS5738ZG - 423G25Mn	EME A	Spain	LX.PAT0X.016	AS5738ZG-423G25Mn VHP32ATES1 MC N10MGE1512Cbb 2G+1G/250/6L/ CB_bgn_0.3D_ES22	PMDT420 0	NLED15.6WXGAG	N10MG E1	512M- DDR2(6 4*16*4)	SO2GBIII10	N250GB5.4KS	NSM8XS	3rd WiFi 1x2 BGN	3rd WiFi 1x2 BGN	N	N	0.3M DV
AS5738ZG - 423G25Mn	EME A	Czech	LX.PAT0X.026	AS5738ZG-423G25Mn VHP32ATCZ2 MC N10MGE1512Cbb 2G+1G/250/6L/ CB_bgn_0.3D_SK12	PMDT420 0	NLED15.6WXGAG	N10MG E1	512M- DDR2(6 4*16*4)	SO2GBIII10	N250GB5.4KS	NSM8XS	3rd WiFi 1x2 BGN	3rd WiFi 1x2 BGN	N	N	0.3M DV
AS5738ZG - 423G25Mn	EME A	Eastern Europe	LX.PAT0X.022	AS5738ZG-423G25Mn VHP32ATEU5 MC N10MGE1512Cbb 2G+1G/250/6L/ CB_bgn_0.3D_PL13	PMDT420 0	NLED15.6WXGAG	N10MG E1	512M- DDR2(6 4*16*4)	SO2GBIII10	N250GB5.4KS	NSM8XS	3rd WiFi 1x2 BGN	3rd WiFi 1x2 BGN	N	N	0.3M DV
AS5738ZG - 423G25Mn	EME A	Belgium	LX.PAT0X.034	AS5738ZG-423G25Mn VHP32ATBE1 MC N10MGE1512Cbb 2G+1G/250/6L/ CB_bgn_0.3D_NL13	PMDT420 0	NLED15.6WXGAG	N10MG E1	512M- DDR2(6 4*16*4)	SO2GBIII10	N250GB5.4KS	NSM8XS	3rd WiFi 1x2 BGN	3rd WiFi 1x2 BGN	N	N	0.3M DV
AS5738ZG - 423G25Mn	EME A	Norway	LX.PAT0X.031	AS5738ZG-423G25Mn VHP32ATNO1 MC N10MGE1512Cbb 2G+1G/250/6L/ CB_bgn_0.3D_NO12	PMDT420 0	NLED15.6WXGAG	N10MG E1	512M- DDR2(6 4*16*4)	SO2GBIII10	N250GB5.4KS	NSM8XS	3rd WiFi 1x2 BGN	3rd WiFi 1x2 BGN	N	N	0.3M DV
AS5738ZG - 423G25Mn	EME A	Norway	LX.PAT0X.030	AS5738ZG-423G25Mn VHP32ATNO3 MC N10MGE1512Cbb 2G+1G/250/6L/ CB_bgn_0.3D_ENS3	PMDT420 0	NLED15.6WXGAG	N10MG E1	512M- DDR2(6 4*16*4)	SO2GBIII10	N250GB5.4KS	NSM8XS	3rd WiFi 1x2 BGN	3rd WiFi 1x2 BGN	N	N	0.3M DV
AS5738ZG - 423G25Mn	EME A	Denmark	LX.PAT0X.037	AS5738ZG-423G25Mn VHP32ATDK2 MC N10MGE1512Cbb 2G+1G/250/6L/ CB_bgn_0.3D_ENS3	PMDT420 0	NLED15.6WXGAG	N10MG E1	512M- DDR2(6 4*16*4)	SO2GBIII10	N250GB5.4KS	NSM8XS	3rd WiFi 1x2 BGN	3rd WiFi 1x2 BGN	N	N	0.3M DV

Model	RO	Country	Acer Part No	Description	CPU	LCD	VGA Chip	VRAM 1	Memory 1/ Memory 2	HDD 1(GB)	ODD	WLAN	WLAN1	Bluetooth	Finger- print	Camera
AS5738ZG - 423G25Mn	EME A	Luxembour g	LX.PAT0X.032	AS5738ZG-423G25Mn VHP32ATLU3 MC N10MGE1512Cbb 2G+1G/250/6L/ CB_bgn_0.3D_IT41	PMDT420 0	NLED15.6WXGAG	N10MG E1	512M- DDR2(6 4*16*4)	SO2GBIII10	N250GB5.4KS	NSM8XS	3rd WiFi 1x2 BGN	3rd WiFi 1x2 BGN	N	N	0.3M DV
AS5738ZG - 423G25Mn	EME A	France	LX.PAT0X.036	AS5738ZG-423G25Mn VHP32ATFR1 MC N10MGE1512Cbb 2G+1G/250/6L/ CB_bgn_0.3D_FR23	PMDT420 0	NLED15.6WXGAG	N10MG E1	512M- DDR2(6 4*16*4)	SO2GBIII10	N250GB5.4KS	NSM8XS	3rd WiFi 1x2 BGN	3rd WiFi 1x2 BGN	N	N	0.3M DV
AS5738ZG - 423G25Mi	EME A	Russia	LX.PAT0X.029	AS5738ZG-423G25Mi VHP32ATRU1 MC N10MGE1512Cbb 2G+1G/250/6L/ CB_bg_0.3D_RU11	PMDT420 0	NLED15.6WXGAG	N10MG E1	512M- DDR2(6 4*16*4)	SO2GBIII10	N250GB5.4KS	NSM8XS	3rd WiFi 1x2 BGN	3rd WiFi BG	N	N	0.3M DV
AS5738ZG - 423G25Mn	EME A	Austria	LX.PAT0X.028	AS5738ZG-423G25Mn VHP32ATAT1 MC N10MGE1512Cbb 2G+1G/250/6L/ CB_bgn_0.3D_DE11	PMDT420 0	NLED15.6WXGAG	N10MG E1	512M- DDR2(6 4*16*4)	SO2GBIII10	N250GB5.4KS	NSM8XS	3rd WiFi 1x2 BGN	3rd WiFi 1x2 BGN	N	N	0.3M DV
AS5738ZG - 423G25Mn	EME A	Sweden	LX.PAT0X.027	AS5738ZG-423G25Mn VHP32ATSE1 MC N10MGE1512Cbb 2G+1G/250/6L/ CB_bgn_0.3D_F113	PMDT420 0	NLED15.6WXGAG	N10MG E1	512M- DDR2(6 4*16*4)	SO2GBIII10	N250GB5.4KS	NSM8XS	3rd WiFi 1x2 BGN	3rd WiFi 1x2 BGN	N	N	0.3M DV
AS5738ZG - 423G25Mn	EME A	Holland	LX.PAT0X.033	AS5738ZG-423G25Mn VHP32ATNL1 MC N10MGE1512Cbb 2G+1G/250/6L/ CB_bgn_0.3D_NL12	PMDT420 0	NLED15.6WXGAG	N10MG E1	512M- DDR2(6 4*16*4)	SO2GBIII10	N250GB5.4KS	NSM8XS	3rd WiFi 1x2 BGN	3rd WiFi 1x2 BGN	N	N	0.3M DV
AS5738ZG - 423G25Mn	EME A	Denmark	LX.PAT0X.038	AS5738ZG-423G25Mn VHP32ATDK1 MC N10MGE1512Cbb 2G+1G/250/6L/ CB_bgn_0.3D_NO13	PMDT420 0	NLED15.6WXGAG	N10MG E1	512M- DDR2(6 4*16*4)	SO2GBIII10	N250GB5.4KS	NSM8XS	3rd WiFi 1x2 BGN	3rd WiFi 1x2 BGN	N	N	0.3M DV
AS5738ZG - 423G25Mn	EME A	Germany	LX.PAT0X.035	AS5738ZG-423G25Mn VHP32ATDE1 MC N10MGE1512Cbb 2G+1G/250/6L/ CB_bgn_0.3D_DE13	PMDT420 0	NLED15.6WXGAG	N10MG E1	512M- DDR2(6 4*16*4)	SO2GBIII10	N250GB5.4KS	NSM8XS	3rd WiFi 1x2 BGN	3rd WiFi 1x2 BGN	N	N	0.3M DV
AS5738ZG - 423G25Mn	EME A	South Africa	LX.PAT0X.040	AS5738ZG-423G25Mn EM VHP32ATZA2 MC N10MGE1512Cbb 2G+1G/250/6L/ CB_bgn_0.3D_EN16	PMDT420 0	NLED15.6WXGAG	N10MG E1	512M- DDR2(6 4*16*4)	SO2GBIII10	N250GB5.4KS	NSM8XS	3rd WiFi 1x2 BGN	3rd WiFi 1x2 BGN	N	N	0.3M DV
AS5738ZG - 422G32Mn	AAP	Australia/ New Zealand	LX.PAT0X.082	AS5738ZG-422G32Mn VHP32ATAU1 MC N10MGE1512Cbb 1*2G/320/B7/6L/ CB_bgn_0.3D_EN12	PMDT420 0	NLED15.6WXGAG	N10MG E1	512M- DDR2(6 4*16*4)	SO2GBIII10/N	N320GB5.4KS	NSM8XS	3rd WiFi 1x2 BGN	3rd WiFi 1x2 BGN	BT 2.0	N	0.3M DV
AS5738ZG - 424G32Mn	EME A	Eastern Europe	LX.PAT0X.044	AS5738ZG-424G32Mn VHP32ATEU5 MC N10MGE1512Cbb 2*2G/320/6L/ CB_bgn_0.3D_RO12	PMDT420 0	NLED15.6WXGAG	N10MG E1	512M- DDR2(6 4*16*4)	SO2GBIII10	N320GB5.4KS	NSM8XS	3rd WiFi 1x2 BGN	3rd WiFi 1x2 BGN	N	N	0.3M DV
AS5738ZG - 424G32Mn	EME A	Norway	LX.PAT0X.071	AS5738ZG-424G32Mn VHP32ATNO3 MC N10MGE1512Cbb 2*2G/320/6L/ CB_bgn_0.3D_ENS3	PMDT420 0	NLED15.6WXGAG	N10MG E1	512M- DDR2(6 4*16*4)	SO2GBIII10	N320GB5.4KS	NSM8XS	3rd WiFi 1x2 BGN	3rd WiFi 1x2 BGN	N	N	0.3M DV
AS5738ZG - 424G32Mn	EME A	Eastern Europe	LX.PAT0X.043	AS5738ZG-424G32Mn VHP32ATEU7 MC N10MGE1512Cbb 2*2G/320/6L/ CB_bgn_0.3D_ENR2	PMDT420 0	NLED15.6WXGAG	N10MG E1	512M- DDR2(6 4*16*4)	SO2GBIII10	N320GB5.4KS	NSM8XS	3rd WiFi 1x2 BGN	3rd WiFi 1x2 BGN	N	N	0.3M DV
AS5738ZG - 424G32Mn	EME A	Eastern Europe	LX.PAT0X.045	AS5738ZG-424G32Mn VHP32ATEU7 MC N10MGE1512Cbb 2*2G/320/6L/ CB_bgn_0.3D_SL11	PMDT420 0	NLED15.6WXGAG	N10MG E1	512M- DDR2(6 4*16*4)	SO2GBIII10	N320GB5.4KS	NSM8XS	3rd WiFi 1x2 BGN	3rd WiFi 1x2 BGN	N	N	0.3M DV
AS5738ZG - 423G25Mn	EME A	South Africa	LX.PAT0X.039	AS5738ZG-423G25Mn EM VHP32ATZA1 MC N10MGE1512Cbb 2G+1G/250/6L/ CB_bgn_0.3D_FR23	PMDT420 0	NLED15.6WXGAG	N10MG E1	512M- DDR2(6 4*16*4)	SO2GBIII10	N250GB5.4KS	NSM8XS	3rd WiFi 1x2 BGN	3rd WiFi 1x2 BGN	N	N	0.3M DV
AS5738ZG - 424G32Mi	EME A	Russia	LX.PAT0X.046	AS5738ZG-424G32Mi VHP32ATRU1 MC N10MGE1512Cbb 2*2G/320/6L/ CB_bg_0.3D_RU11	PMDT420 0	NLED15.6WXGAG	N10MG E1	512M- DDR2(6 4*16*4)	SO2GBIII10	N320GB5.4KS	NSM8XS	3rd WiFi 1x2 BGN	3rd WiFi BG	N	N	0.3M DV
AS5738ZG - 424G32Mn	EME A	Austria	LX.PAT0X.070	AS5738ZG-424G32Mn VHP32ATAT1 MC N10MGE1512Cbb 2*2G/320/6L/ CB_bgn_0.3D_DE11	PMDT420 0	NLED15.6WXGAG	N10MG E1	512M- DDR2(6 4*16*4)	SO2GBIII10	N320GB5.4KS	NSM8XS	3rd WiFi 1x2 BGN	3rd WiFi 1x2 BGN	N	N	0.3M DV
AS5738ZG - 424G32Mn	EME A	Sweden	LX.PAT0X.069	AS5738ZG-424G32Mn VHP32ATSE1 MC N10MGE1512Cbb 2*2G/320/6L/ CB_bgn_0.3D_F113	PMDT420 0	NLED15.6WXGAG	N10MG E1	512M- DDR2(6 4*16*4)	SO2GBIII10	N320GB5.4KS	NSM8XS	3rd WiFi 1x2 BGN	3rd WiFi 1x2 BGN	N	N	0.3M DV



Model	RO	Country	Acer Part No	Description	CPU	LCD	VGA Chip	VRAM 1	Memory 1/ Memory 2	HDD 1(GB)	ODD	WLAN	WLAN1	Bluetooth	Finger- print	Camera
AS5738ZG-424G32Mn	EME A	Czech	LX.PAT0X.068	AS5738ZG-424G32Mn VHP32ATCZ2 MC N10MGE1512Cbb 2*2G/320/6L/ CB_bgn_0.3D_SK12	PMDT4200	NLED15.6WXGAG	N10MG E1	512M-DDR2(6 4*16*4)	SO2GBIII10	N320GB5.4KS	NSM8XS	3rd WiFi 1x2 BGN	3rd WiFi 1x2 BGN	N	N	0.3M DV
AS5738ZG-424G32Mn	EME A	Eastern Europe	LX.PAT0X.042	AS5738ZG-424G32Mn VHP32ATEU5 MC N10MGE1512Cbb 2*2G/320/6L/ CB_bgn_0.3D_PL13	PMDT4200	NLED15.6WXGAG	N10MG E1	512M-DDR2(6 4*16*4)	SO2GBIII10	N320GB5.4KS	NSM8XS	3rd WiFi 1x2 BGN	3rd WiFi 1x2 BGN	N	N	0.3M DV
AS5738ZG-424G32Mn	EME A	Belgium	LX.PAT0X.080	AS5738ZG-424G32Mn VHP32ATBE1 MC N10MGE1512Cbb 2*2G/320/6L/ CB_bgn_0.3D_NL13	PMDT4200	NLED15.6WXGAG	N10MG E1	512M-DDR2(6 4*16*4)	SO2GBIII10	N320GB5.4KS	NSM8XS	3rd WiFi 1x2 BGN	3rd WiFi 1x2 BGN	N	N	0.3M DV
AS5738ZG-423G32Mn	EME A	Middle East	LX.PAT0C.002	AS5738ZG-423G32Mn LNPUSAME6 N10MGE1512Cbb 2G+1G/320/BT/6L/ CB_bg_0.3D_EN13	PMDT4200	NLED15.6WXGAG	N10MG E1	512M-DDR2(6 4*16*4)	SO2GBIII10	N320GB5.4KS	NSM8XS	3rd WiFi 1x2 BGN	3rd WiFi 1x2 BGN	BT 2.0	N	0.3M DV
AS5738ZG-424G32Mn	EME A	Norway	LX.PAT0X.047	AS5738ZG-424G32Mn VHP32ATNO1 MC N10MGE1512Cbb 2*2G/320/6L/ CB_bgn_0.3D_NO12	PMDT4200	NLED15.6WXGAG	N10MG E1	512M-DDR2(6 4*16*4)	SO2GBIII10	N320GB5.4KS	NSM8XS	3rd WiFi 1x2 BGN	3rd WiFi 1x2 BGN	N	N	0.3M DV
AS5738ZG-424G32Mi	EME A	Ukraine	LX.PAT0X.079	AS5738ZG-424G32Mi VHP32ATUK1 MC N10MGE1512Cbb 2*2G/320/6L/ CB_bg_0.3D_RU11	PMDT4200	NLED15.6WXGAG	N10MG E1	512M-DDR2(6 4*16*4)	SO2GBIII10	N320GB5.4KS	NSM8XS	3rd WiFi 1x2 BGN	3rd WiFi BG	N	N	0.3M DV
AS5738ZG-424G32Mn	EME A	Luxembourg	LX.PAT0X.081	AS5738ZG-424G32Mn VHP32ATLU3 MC N10MGE1512Cbb 2*2G/320/6L/ CB_bgn_0.3D_IT14	PMDT4200	NLED15.6WXGAG	N10MG E1	512M-DDR2(6 4*16*4)	SO2GBIII10	N320GB5.4KS	NSM8XS	3rd WiFi 1x2 BGN	3rd WiFi 1x2 BGN	N	N	0.3M DV
AS5738ZG-424G32Mn	EME A	Switzerland	LX.PAT0X.050	AS5738ZG-424G32Mn VHP32ATCH1 MC N10MGE1512Cbb 2*2G/320/6L/ CB_bgn_0.3D_IT42	PMDT4200	NLED15.6WXGAG	N10MG E1	512M-DDR2(6 4*16*4)	SO2GBIII10	N320GB5.4KS	NSM8XS	3rd WiFi 1x2 BGN	3rd WiFi 1x2 BGN	N	N	0.3M DV
AS5738ZG-423G32Mn	EME A	Middle East	LX.PAT0C.001	AS5738ZG-423G32Mn LNPUSAME2 N10MGE1512Cbb 2G+1G/320/BT/6L/ CB_bg_0.3D_EN13	PMDT4200	NLED15.6WXGAG	N10MG E1	512M-DDR2(6 4*16*4)	SO2GBIII10	N320GB5.4KS	NSM8XS	3rd WiFi 1x2 BGN	3rd WiFi 1x2 BGN	BT 2.0	N	0.3M DV
AS5738ZG-423G32Mn	EME A	Middle East	LX.PAT0X.041	AS5738ZG-423G32Mn EM VHP32ATME2 MC N10MGE1512Cbb 2G+1G/320/BT/6L/ CB_bgn_0.3D_AR23	PMDT4200	NLED15.6WXGAG	N10MG E1	512M-DDR2(6 4*16*4)	SO2GBIII10	N320GB5.4KS	NSM8XS	3rd WiFi 1x2 BGN	3rd WiFi 1x2 BGN	BT 2.0	N	0.3M DV
AS5738ZG-424G32Mn	EME A	UK	LX.PAT0X.049	AS5738ZG-424G32Mn VHP32ATGB1 MC N10MGE1512Cbb 2*2G/320/6L/ CB_bgn_0.3D_EN14	PMDT4200	NLED15.6WXGAG	N10MG E1	512M-DDR2(6 4*16*4)	SO2GBIII10	N320GB5.4KS	NSM8XS	3rd WiFi 1x2 BGN	3rd WiFi 1x2 BGN	N	N	0.3M DV
AS5738ZG-424G32Mn	EME A	Holland	LX.PAT0X.048	AS5738ZG-424G32Mn VHP32ATNL1 MC N10MGE1512Cbb 2*2G/320/6L/ CB_bgn_0.3D_NL12	PMDT4200	NLED15.6WXGAG	N10MG E1	512M-DDR2(6 4*16*4)	SO2GBIII10	N320GB5.4KS	NSM8XS	3rd WiFi 1x2 BGN	3rd WiFi 1x2 BGN	N	N	0.3M DV
AS5738ZG-423G25Bn	EME A	UK	LX.PC50Y.001	AS5738ZG-423G25Bn VHB32ATGB1 MC N10MGE1512bb 2G+1G/250/6L/ CB_bgn_HG_EN14	PMDT4200	NLED15.6WXGAG	N10MG E1	512M-DDR2(6 4*16*4)	SO2GBIII10	N250GB5.4KS	NBDCB4XS	3rd WiFi 1x2 BGN	3rd WiFi 1x2 BGN	N	N	N
AS5738Z-423G25Mn	AAP	Australia/ New Zealand	LX.PAS0X.003	AS5738Z-423G25Mn VHP32ATAU1 MC UMACFbb 2G+1G/250/BT/6L/5R/ CB_bgn_FP_0.3D_EN12	PMDT4200	NLED15.6WXGAG	UMA	N	SO2GBIII10	N250GB5.4KS	NSM8XS	3rd WiFi 1x2 BGN	3rd WiFi 1x2 BGN	BT 2.0	AES1610	0.3M DV
AS5738Z-422G32Mn	TW N	GCTWN	LX.PAS0Y.001	AS5738Z-422G32Mn VHB32ATTW1 MC UMACFbbM 1*2G/320/BT/6L/ CB_bgn_FP_0.3D_TC11	PMDT4200	NLED15.6WXGAG	UMA	N	SO2GBIII10/N	N320GB5.4KS	NSM8XS	3rd WiFi 1x2 BGN	3rd WiFi 1x2 BGN	BT 2.0	AES1610	0.3M DV
AS5738Z-424G32Mn	AAP	Australia/ New Zealand	LX.PAS0X.002	AS5738Z-424G32Mn VHP32ATAU1 MC UMACFbbM 2*2G/320/BT/6L/5R/ CB_bgn_FP_0.3D_EN12	PMDT4200	NLED15.6WXGAG	UMA	N	SO2GBIII10	N320GB5.4KS	NSM8XS	3rd WiFi 1x2 BGN	3rd WiFi 1x2 BGN	BT 2.0	AES1610	0.3M DV
AS5738Z-422G25Mn	AAP	Australia/ New Zealand	LX.PAS0X.001	AS5738Z-422G25Mn VHP32ATAU1 MC UMACFbbM 1*2G/250/BT/6L/5R/ CB_bgn_FP_0.3D_EN12	PMDT4200	NLED15.6WXGAG	UMA	N	SO2GBIII10/N	N250GB5.4KS	NSM8XS	3rd WiFi 1x2 BGN	3rd WiFi 1x2 BGN	BT 2.0	AES1610	0.3M DV
AS5738Z-422G25Mn	AAP	Australia/ New Zealand	LX.PAS0Y.003	AS5738Z-422G25Mn VHB32ATAU1 MC UMACFbbM 1*2G/250/BT/6L/5R/ CB_bg_FP_0.3D_EN12	PMDT4200	NLED15.6WXGAG	UMA	N	SO2GBIII10/N	N250GB5.4KS	NSM8XS	3rd WiFi 1x2 BGN	3rd WiFi 1x2 BGN	BT 2.0	AES1610	0.3M DV

Model	RO	Country	Acer Part No	Description	CPU	LCD	VGA Chip	VRAM 1	Memory 1/ Memory 2	HDD 1(GB)	ODD	WLAN	WLAN1	Bluetooth	Finger- print	Camera
AS5738Z-422G25Mn	TW N	GCTWN	LX.PAS0Y.002	AS5738Z-422G25Mn VHB32ATW1 MC UMACFbbM 1*2G/250/BT/6L/ CB_bgn_FP_0.3D_TC21	PMDT420 0	NLED15.6WXGAG	UMA	N	SO2GBIII10/N	N250GB5.4KS	NSM8XS	3rd WiFi 1x2 BGN	3rd WiFi 1x2 BGN	BT 2.0	AES161 0	0.3M DV
AS5738Z-422G16Mn	EME A	Poland	LX.PAR0X.084	AS5738Z-422G16Mn VHP32ATPL1 MC UMACbb 1*2G/160/6L/5R/CB_bgn_0.3D_PL11	PMDT420 0	NLED15.6WXGAG	UMA	N	SO2GBIII10/N	N160GB5.4KS	NSM8XS	3rd WiFi 1x2 BGN	3rd WiFi 1x2 BGN	N	N	0.3M DV
AS5738Z-424G32Mn	EME A	Denmark	LX.PAR0X.082	AS5738Z-424G32Mn VHP32ATDK2 MC UMACbb 2*2G/320/6L/5R/CB_bgn_0.3D_ENS3	PMDT420 0	NLED15.6WXGAG	UMA	N	SO2GBIII10	N320GB5.4KS	NSM8XS	3rd WiFi 1x2 BGN	3rd WiFi 1x2 BGN	N	N	0.3M DV
AS5738Z-423G16Mn	EME A	Poland	LX.PAR0X.083	AS5738Z-423G16Mn VHP32ATPL1 MC UMACbb 2G+1G/160/6L/5R/ CB_bgn_0.3D_PL11	PMDT420 0	NLED15.6WXGAG	UMA	N	SO2GBIII10	N160GB5.4KS	NSM8XS	3rd WiFi 1x2 BGN	3rd WiFi 1x2 BGN	N	N	0.3M DV
AS5738Z-422G25Mn	AAP	Vietnam	LX.PAR0Y.015	AS5738Z-422G25Mn EM VHB32ATVN1 MC UMACbb 1*2G/250/BT/6L/5R/ CB_bgn_0.3D_EN13	PMDT420 0	NLED15.6WXGAG	UMA	N	SO2GBIII10/N	N250GB5.4KS	NSM8XS	3rd WiFi 1x2 BGN	3rd WiFi 1x2 BGN	BT 2.0	N	0.3M DV
AS5738Z-423G25Mn	EME A	Eastern Europe	LX.PAR0C.010	AS5738Z-423G25Mn LNPUSAEU5 UMACbb 2G+1G/250/6L/5R/CB_bgn_0.3D_EN43	PMDT420 0	NLED15.6WXGAG	UMA	N	SO2GBIII10	N250GB5.4KS	NSM8XS	3rd WiFi 1x2 BGN	3rd WiFi 1x2 BGN	N	N	0.3M DV
AS5738Z-421G25Mn	AAP	Vietnam	LX.PAR0C.013	AS5738Z-421G25Mn LNPUSAVN1 UMACbb 1*1G/250/BT/6L/5R/CB_bgn_0.3D_EN11	PMDT420 0	NLED15.6WXGAG	UMA	N	SO1GBIII10/N	N250GB5.4KS	NSM8XS	3rd WiFi 1x2 BGN	3rd WiFi 1x2 BGN	BT 2.0	N	0.3M DV
AS5738Z-422G32Mn	AAP	Vietnam	LX.PAR0C.011	AS5738Z-422G32Mn LNPUSAVN1 UMACbb 1*2G/320/BT/6L/5R/CB_bgn_0.3D_EN11	PMDT420 0	NLED15.6WXGAG	UMA	N	SO2GBIII10/N	N320GB5.4KS	NSM8XS	3rd WiFi 1x2 BGN	3rd WiFi 1x2 BGN	BT 2.0	N	0.3M DV
AS5738Z-422G25Mn	AAP	Vietnam	LX.PAR0C.012	AS5738Z-422G25Mn LNPUSAVN1 UMACbb 1*2G/250/BT/6L/5R/CB_bgn_0.3D_EN11	PMDT420 0	NLED15.6WXGAG	UMA	N	SO2GBIII10/N	N250GB5.4KS	NSM8XS	3rd WiFi 1x2 BGN	3rd WiFi 1x2 BGN	BT 2.0	N	0.3M DV
AS5738Z-423G32Mn	EME A	Eastern Europe	LX.PAR0C.009	AS5738Z-423G32Mn LNPUSAEU5 UMACbb 2G+1G/320/6L/5R/CB_bgn_0.3D_EN43	PMDT420 0	NLED15.6WXGAG	UMA	N	SO2GBIII10	N320GB5.4KS	NSM8XS	3rd WiFi 1x2 BGN	3rd WiFi 1x2 BGN	N	N	0.3M DV
AS5738Z-423G32Mn	PA	ACLA- Spanish	LX.PAR0X.080	AS5738Z-423G32Mn EM VHP32ATEA3 MC UMACbb 2G+1G/320/BT/6L/5R/ CB_bgn_0.3D_ES22	PMDT420 0	NLED15.6WXGAG	UMA	N	SO2GBIII10	N320GB5.4KS	NSM8XS	3rd WiFi 1x2 BGN	3rd WiFi 1x2 BGN	BT 2.0	N	0.3M DV
AS5738Z-423G32Mn	PA	ACLA- Portuguese	LX.PAR0X.081	AS5738Z-423G32Mn EM VHP32ATXC2 MC UMACbb 2G+1G/320/BT/6L/5R/ CB_bgn_0.3D_XC21	PMDT420 0	NLED15.6WXGAG	UMA	N	SO2GBIII10	N320GB5.4KS	NSM8XS	3rd WiFi 1x2 BGN	3rd WiFi 1x2 BGN	BT 2.0	N	0.3M DV
AS5738Z-423G25Mn	EME A	Eastern Europe	LX.PAR0C.007	AS5738Z-423G25Mn LNPUSAEU7 UMACbb 2G+1G/250/BT/6L/5R/CB_bgn_0.3D_EN11	PMDT420 0	NLED15.6WXGAG	UMA	N	SO2GBIII10	N250GB5.4KS	NSM8XS	3rd WiFi 1x2 BGN	3rd WiFi 1x2 BGN	BT 2.0	N	0.3M DV
AS5738Z-422G25Mn	EME A	Middle East	LX.PAR0C.006	AS5738Z-422G25Mn LNPUSAME4 UMACbb 1*2G/250/BT/6L/5R/CB_bgn_0.3D_EN72	PMDT420 0	NLED15.6WXGAG	UMA	N	SO2GBIII10/N	N250GB5.4KS	NSM8XS	3rd WiFi 1x2 BGN	3rd WiFi 1x2 BGN	BT 2.0	N	0.3M DV
AS5738Z-424G50Mn	EME A	Eastern Europe	LX.PAR0C.008	AS5738Z-424G50Mn LNPUSAEU5 UMACbb 2*2G/500_L/BT/6L/5R/CB_bgn_0.3D_EN43	PMDT420 0	NLED15.6WXGAG	UMA	N	SO2GBIII10	N500GB5.4KS	NSM8XS	3rd WiFi 1x2 BGN	3rd WiFi 1x2 BGN	BT 2.0	N	0.3M DV
AS5738Z-423G32Mn	PA	ACLA- Spanish	LX.PAR0X.079	AS5738Z-423G32Mn EM VHP32ATEA1 MC UMACbb 2G+1G/320/BT/6L/5R/ CB_bgn_0.3D_ES22	PMDT420 0	NLED15.6WXGAG	UMA	N	SO2GBIII10	N320GB5.4KS	NSM8XS	3rd WiFi 1x2 BGN	3rd WiFi 1x2 BGN	BT 2.0	N	0.3M DV
AS5738Z-422G32Mn	EME A	UK	LX.PAR0X.078	AS5738Z-422G32Mn VHP32ATGB1 MC UMACbb 1*2G/320/6L/5R/CB_bgn_0.3D_EN14	PMDT420 0	NLED15.6WXGAG	UMA	N	SO2GBIII10/N	N320GB5.4KS	NSM8XS	3rd WiFi 1x2 BGN	3rd WiFi 1x2 BGN	N	N	0.3M DV
AS5738Z-424G25Mn	EME A	France	LX.PAR0Y.014	AS5738Z-424G25Mn VHB32ATFR1 MC UMACbb 2*2G/250/6L/5R/CB_bgn_0.3D_FR23	PMDT420 0	NLED15.6WXGAG	UMA	N	SO2GBIII10	N250GB5.4KS	NSM8XS	3rd WiFi 1x2 BGN	3rd WiFi 1x2 BGN	N	N	0.3M DV
AS5738Z-424G50Mn	EME A	UK	LX.PAR0X.077	AS5738Z-424G50Mn VHP32ATGB1 MC UMACbb 2*2G/500_L/6L/5R/ CB_bgn_0.3D_EN14	PMDT420 0	NLED15.6WXGAG	UMA	N	SO2GBIII10	N500GB5.4KS	NSM8XS	3rd WiFi 1x2 BGN	3rd WiFi 1x2 BGN	N	N	0.3M DV
AS5738Z-424G32Mn	EME A	UK	LX.PAR0X.076	AS5738Z-424G32Mn VHP32ATGB1 MC UMACbb 2*2G/320/6L/5R/CB_bgn_0.3D_EN14	PMDT420 0	NLED15.6WXGAG	UMA	N	SO2GBIII10	N320GB5.4KS	NSM8XS	3rd WiFi 1x2 BGN	3rd WiFi 1x2 BGN	N	N	0.3M DV
AS5738Z-422G25Mn	PA	USA	LX.PAR0C.005	AS5738Z-422G25Mn LNPUSAU5 UMACbb 2*1G/250/6L/5R/CB_bgn_0.3D_EN31	PMDT420 0	NLED15.6WXGAG	UMA	N	SO1GBIII10	N250GB5.4KS	NSM8XS	3rd WiFi 1x2 BGN	3rd WiFi 1x2 BGN	N	N	0.3M DV
AS5738Z-422G25Mn	PA	ACLA- Portuguese	LX.PAR0C.004	AS5738Z-422G25Mn LNPUSAXC2 UMACbb 2*1G/250/6L/5R/CB_bgn_0.3D_EN62	PMDT420 0	NLED15.6WXGAG	UMA	N	SO1GBIII10	N250GB5.4KS	NSM8XS	3rd WiFi 1x2 BGN	3rd WiFi 1x2 BGN	N	N	0.3M DV
AS5738Z-422G25Mn	PA	ACLA- Spanish	LX.PAR0C.003	AS5738Z-422G25Mn LNPUSAE1 UMACbb 2*1G/250/6L/5R/CB_bgn_0.3D_EN61	PMDT420 0	NLED15.6WXGAG	UMA	N	SO1GBIII10	N250GB5.4KS	NSM8XS	3rd WiFi 1x2 BGN	3rd WiFi 1x2 BGN	N	N	0.3M DV

Model	RO	Country	Acer Part No	Description	CPU	LCD	VGA Chip	VRAM 1	Memory 1/ Memory 2	HDD 1(GB)	ODD	WLAN	WLAN1	Bluetooth	Finger- print	Camera
AS5738Z-422G25Mn	PA	ACLA-Spanish	LX.PAR0C.002	AS5738Z-422G25Mn LINPUSAE3 UMACbb 2*1G/250/6L/5R/CB_bgn_0.3D_EN61	PMDT4200	NLED15.6WXGAG	UMA	N	SO1GBIII10	N250GB5.4KS	NSM8XS	3rd WiFi 1x2 BGN	3rd WiFi 1x2 BGN	N	N	0.3M DV
AS5738Z-424G32Mn	EME A	Switzerland	LX.PAR0X.075	AS5738Z-424G32Mn VHP32ATC1 MC UMACbb 2*2G/320/6L/5R/CB_bgn_0.3D_IT42	PMDT4200	NLED15.6WXGAG	UMA	N	SO2GBIII10	N320GB5.4KS	NSM8XS	3rd WiFi 1x2 BGN	3rd WiFi 1x2 BGN	N	N	0.3M DV
AS5738Z-423G50Mn	PA	ACLA-Spanish	LX.PAR0X.073	AS5738Z-423G50Mn EM VHP32ATEA3 MC UMACbb 2G+1G/500_L/BT/6L/5R/CB_bgn_0.3D_ES22	PMDT4200	NLED15.6WXGAG	UMA	N	SO2GBIII10	N500GB5.4KS	NSM8XS	3rd WiFi 1x2 BGN	3rd WiFi 1x2 BGN	BT 2.0	N	0.3M DV
AS5738Z-423G50Mn	PA	ACLA-Spanish	LX.PAR0X.072	AS5738Z-423G50Mn EM VHP32ATEA1 MC UMACbb 2G+1G/500_L/BT/6L/5R/CB_bgn_0.3D_ES22	PMDT4200	NLED15.6WXGAG	UMA	N	SO2GBIII10	N500GB5.4KS	NSM8XS	3rd WiFi 1x2 BGN	3rd WiFi 1x2 BGN	BT 2.0	N	0.3M DV
AS5738Z-423G50Mn	PA	ACLA-Portuguese	LX.PAR0X.074	AS5738Z-423G50Mn EM VHP32ATXC2 MC UMACbb 2G+1G/500_L/BT/6L/5R/CB_bgn_0.3D_XC21	PMDT4200	NLED15.6WXGAG	UMA	N	SO2GBIII10	N500GB5.4KS	NSM8XS	3rd WiFi 1x2 BGN	3rd WiFi 1x2 BGN	BT 2.0	N	0.3M DV
AS5738Z-423G32Mn	EME A	Switzerland	LX.PAR0X.071	AS5738Z-423G32Mn VHP32ATC1 MC UMACbb 2G+1G/320/6L/5R/CB_bgn_0.3D_IT42	PMDT4200	NLED15.6WXGAG	UMA	N	SO2GBIII10	N320GB5.4KS	NSM8XS	3rd WiFi 1x2 BGN	3rd WiFi 1x2 BGN	N	N	0.3M DV
AS5738Z-422G25Mn	EME A	Middle East	LX.PAR0C.001	AS5738Z-422G25Mn LINPUSAME2 UMACbb 1*2G/250/BT/6L/5R/CB_bgn_0.3D_EN13	PMDT4200	NLED15.6WXGAG	UMA	N	SO2GBIII10/N	N250GB5.4KS	NSM8XS	3rd WiFi 1x2 BGN	3rd WiFi 1x2 BGN	BT 2.0	N	0.3M DV
AS5738Z-422G25Mn	EME A	Middle East	LX.PAR0X.070	AS5738Z-422G25Mn EM VHP32ATME2 MC UMACbb 1*2G/250/BT/6L/5R/CB_bgn_0.3D_AR23	PMDT4200	NLED15.6WXGAG	UMA	N	SO2GBIII10/N	N250GB5.4KS	NSM8XS	3rd WiFi 1x2 BGN	3rd WiFi 1x2 BGN	BT 2.0	N	0.3M DV
AS5738Z-424G50Mn	EME A	Spain	LX.PAR0X.068	AS5738Z-424G50Mn VHP32ATES1 MC UMACbbM 2*2G/500_L/6L/5R/CB_bgn_0.3D_ES22	PMDT4200	NLED15.6WXGAG	UMA	N	SO2GBIII10	N500GB5.4KS	NSM8XS	3rd WiFi 1x2 BGN	3rd WiFi 1x2 BGN	N	N	0.3M DV
AS5738Z-424G32Mn	EME A	Spain	LX.PAR0X.069	AS5738Z-424G32Mn VHP32ATES1 MC UMACbbM 2*2G/320/6L/5R/CB_bgn_0.3D_ES22	PMDT4200	NLED15.6WXGAG	UMA	N	SO2GBIII10	N320GB5.4KS	NSM8XS	3rd WiFi 1x2 BGN	3rd WiFi 1x2 BGN	N	N	0.3M DV
AS5738Z-422G32Mn	PA	ACLA-Spanish	LX.PAR0X.061	AS5738Z-422G32Mn EM VHP32ATEA3 MC UMACbbM 2*1G/320/6L/5R/CB_bgn_0.3D_ES22	PMDT4200	NLED15.6WXGAG	UMA	N	SO1GBIII10	N320GB5.4KS	NSM8XS	3rd WiFi 1x2 BGN	3rd WiFi 1x2 BGN	N	N	0.3M DV
AS5738Z-424G50Mn	EME A	France	LX.PAR0X.004	AS5738Z-424G50Mn VHP32ATFR1 MC UMACbbM 2*2G/500_L/6L/5R/CB_bgn_0.3D_FR23	PMDT4200	NLED15.6WXGAG	UMA	N	SO2GBIII10	N500GB5.4KS	NSM8XS	3rd WiFi 1x2 BGN	3rd WiFi 1x2 BGN	N	N	0.3M DV
AS5738Z-424G50Mn	EME A	Czech	LX.PAR0X.067	AS5738Z-424G50Mn VHP32ATC22 MC UMACbbM 2*2G/500_L/BT/6L/5R/CB_bgn_0.3D_SK12	PMDT4200	NLED15.6WXGAG	UMA	N	SO2GBIII10	N500GB5.4KS	NSM8XS	3rd WiFi 1x2 BGN	3rd WiFi 1x2 BGN	BT 2.0	N	0.3M DV
AS5738Z-424G32Mn	EME A	Czech	LX.PAR0X.066	AS5738Z-424G32Mn VHP32ATC22 MC UMACbbM 2*2G/320/BT/6L/5R/CB_bgn_0.3D_SK12	PMDT4200	NLED15.6WXGAG	UMA	N	SO2GBIII10	N320GB5.4KS	NSM8XS	3rd WiFi 1x2 BGN	3rd WiFi 1x2 BGN	BT 2.0	N	0.3M DV
AS5738Z-423G32Mn	EME A	Czech	LX.PAR0X.065	AS5738Z-423G32Mn VHP32ATC22 MC UMACbbM 2G+1G/320/BT/6L/5R/CB_bgn_0.3D_SK12	PMDT4200	NLED15.6WXGAG	UMA	N	SO2GBIII10	N320GB5.4KS	NSM8XS	3rd WiFi 1x2 BGN	3rd WiFi 1x2 BGN	BT 2.0	N	0.3M DV
AS5738Z-422G32Mn	EME A	Czech	LX.PAR0X.063	AS5738Z-422G32Mn VHP32ATC22 MC UMACbbM 1*2G/320/BT/6L/5R/CB_bgn_0.3D_SK12	PMDT4200	NLED15.6WXGAG	UMA	N	SO2GBIII10/N	N320GB5.4KS	NSM8XS	3rd WiFi 1x2 BGN	3rd WiFi 1x2 BGN	BT 2.0	N	0.3M DV
AS5738Z-423G32Mn	EME A	Czech	LX.PAR0X.064	AS5738Z-423G32Mn VHP32ATC22 MC UMACbbM 2G+1G/320/6L/5R/CB_bgn_0.3D_SK12	PMDT4200	NLED15.6WXGAG	UMA	N	SO2GBIII10	N320GB5.4KS	NSM8XS	3rd WiFi 1x2 BGN	3rd WiFi 1x2 BGN	N	N	0.3M DV
AS5738Z-422G32Mn	PA	ACLA-Spanish	LX.PAR0X.060	AS5738Z-422G32Mn EM VHP32ATEA1 MC UMACbbM 2*1G/320/6L/5R/CB_bgn_0.3D_ES22	PMDT4200	NLED15.6WXGAG	UMA	N	SO1GBIII10	N320GB5.4KS	NSM8XS	3rd WiFi 1x2 BGN	3rd WiFi 1x2 BGN	N	N	0.3M DV
AS5738Z-422G25Mn	PA	ACLA-Spanish	LX.PAR0X.057	AS5738Z-422G25Mn EM VHP32ATEA1 MC UMACbbM 2*1G/250/6L/5R/CB_bgn_0.3D_ES22	PMDT4200	NLED15.6WXGAG	UMA	N	SO1GBIII10	N250GB5.4KS	NSM8XS	3rd WiFi 1x2 BGN	3rd WiFi 1x2 BGN	N	N	0.3M DV

Model	RO	Country	Acer Part No	Description	CPU	LCD	VGA Chip	VRAM 1	Memory 1/ Memory 2	HDD 1(GB)	ODD	WLAN	WLAN1	Bluetooth	Finger- print	Camera
AS5738Z-422G25Mn	PA	ACLA-Spanish	LX.PAR0X.058	AS5738Z-422G25Mn EM VHP32ATEA3 MC UMACbbM 2*1G/250/6L/5R/ CB_bgn_0.3D_ES22	PMDT4200	NLED15.6WGXGAG	UMA	N	SO1GBIII10	N250GB5.4KS	NSM8XS	3rd WiFi 1x2 BGN	3rd WiFi 1x2 BGN	N	N	0.3M DV
AS5738Z-423G25Mn	PA	ACLA-Spanish	LX.PAR0X.055	AS5738Z-423G25Mn EM VHP32ATEA3 MC UMACbbM 2G+1G/250/6L/5R/ CB_bgn_0.3D_ES22	PMDT4200	NLED15.6WGXGAG	UMA	N	SO2GBIII10	N250GB5.4KS	NSM8XS	3rd WiFi 1x2 BGN	3rd WiFi 1x2 BGN	N	N	0.3M DV
AS5738Z-423G32Mn	PA	ACLA-Spanish	LX.PAR0X.052	AS5738Z-423G32Mn EM VHP32ATEA3 MC UMACbbM 2G+1G/320/6L/5R/ CB_bgn_0.3D_ES22	PMDT4200	NLED15.6WGXGAG	UMA	N	SO2GBIII10	N320GB5.4KS	NSM8XS	3rd WiFi 1x2 BGN	3rd WiFi 1x2 BGN	N	N	0.3M DV
AS5738Z-422G32Mn	PA	ACLA-Portuguese	LX.PAR0X.062	AS5738Z-422G32Mn EM VHP32ATXC2 MC UMACbbM 2*1G/320/6L/5R/ CB_bgn_0.3D_XC21	PMDT4200	NLED15.6WGXGAG	UMA	N	SO1GBIII10	N320GB5.4KS	NSM8XS	3rd WiFi 1x2 BGN	3rd WiFi 1x2 BGN	N	N	0.3M DV
AS5738Z-423G25Mn	PA	ACLA-Portuguese	LX.PAR0X.056	AS5738Z-423G25Mn EM VHP32ATXC1 MC UMACbbM 2G+1G/250/6L/5R/ CB_bgn_0.3D_XC22	PMDT4200	NLED15.6WGXGAG	UMA	N	SO2GBIII10	N250GB5.4KS	NSM8XS	3rd WiFi 1x2 BGN	3rd WiFi 1x2 BGN	N	N	0.3M DV
AS5738Z-423G32Mn	PA	ACLA-Portuguese	LX.PAR0X.053	AS5738Z-423G32Mn EM VHP32ATXC2 MC UMACbbM 2G+1G/320/6L/5R/ CB_bgn_0.3D_XC21	PMDT4200	NLED15.6WGXGAG	UMA	N	SO2GBIII10	N320GB5.4KS	NSM8XS	3rd WiFi 1x2 BGN	3rd WiFi 1x2 BGN	N	N	0.3M DV
AS5738Z-422G25Mn	PA	ACLA-Portuguese	LX.PAR0X.059	AS5738Z-422G25Mn EM VHP32ATXC2 MC UMACbbM 2*1G/250/6L/5R/ CB_bgn_0.3D_XC21	PMDT4200	NLED15.6WGXGAG	UMA	N	SO1GBIII10	N250GB5.4KS	NSM8XS	3rd WiFi 1x2 BGN	3rd WiFi 1x2 BGN	N	N	0.3M DV
AS5738Z-423G32Mn	PA	ACLA-Spanish	LX.PAR0X.051	AS5738Z-423G32Mn EM VHP32ATEA1 MC UMACbbM 2G+1G/320/6L/5R/ CB_bgn_0.3D_ES22	PMDT4200	NLED15.6WGXGAG	UMA	N	SO2GBIII10	N320GB5.4KS	NSM8XS	3rd WiFi 1x2 BGN	3rd WiFi 1x2 BGN	N	N	0.3M DV
AS5738Z-423G25Mn	PA	ACLA-Spanish	LX.PAR0X.054	AS5738Z-423G25Mn EM VHP32ATEA1 MC UMACbbM 2G+1G/250/6L/5R/ CB_bgn_0.3D_ES22	PMDT4200	NLED15.6WGXGAG	UMA	N	SO2GBIII10	N250GB5.4KS	NSM8XS	3rd WiFi 1x2 BGN	3rd WiFi 1x2 BGN	N	N	0.3M DV
AS5738Z-423G32Mn	PA	USA	LX.PAR0X.050	AS5738Z-423G32Mn VHP32ATUS1 MC UMACbbM 2G+1G/320/6L/5R/ CB_bgn_0.3D_FRB1	PMDT4200	NLED15.6WGXGAG	UMA	N	SO2GBIII10	N320GB5.4KS	NSM8XS	3rd WiFi 1x2 BGN	3rd WiFi 1x2 BGN	N	N	0.3M DV
AS5738Z-423G25Mn	EME A	Israel	LX.PAR0X.043	AS5738Z-423G25Mn VHP32ATIL1 MC UMACbbM 2G+1G/250/6L/5R/ CB_bgn_0.3D_HE12	PMDT4200	NLED15.6WGXGAG	UMA	N	SO2GBIII10	N250GB5.4KS	NSM8XS	3rd WiFi 1x2 BGN	3rd WiFi 1x2 BGN	N	N	0.3M DV
AS5738Z-421G16Mn	AAP	India	LX.PAR0Y.013	AS5738Z-421G16Mn VHB32ATIN1 MC UMACbbM 1*1G/160/6L/5R/ CB_bg_0.3D_EN12	PMDT4200	NLED15.6WGXGAG	UMA	N	SO1GBIII10/N	N160GB5.4KS	NSM8XS	3rd WiFi 1x2 BGN	3rd WiFi 1x2 BGN	BT 2.0	N	0.3M DV
AS5738Z-422G25Mn	AAP	India	LX.PAR0Y.011	AS5738Z-422G25Mn VHB32ATIN1 MC UMACbbM 1*2G/250/6L/5R/ CB_bg_0.3D_EN12	PMDT4200	NLED15.6WGXGAG	UMA	N	SO2GBIII10/N	N250GB5.4KS	NSM8XS	3rd WiFi 1x2 BGN	3rd WiFi 1x2 BGN	BT 2.0	N	0.3M DV
AS5738Z-423G25Mn	EME A	Italy	LX.PAR0X.044	AS5738Z-423G25Mn VHP32ATIT1 MC UMACbbM 2G+1G/250/6L/5R/ CB_bgn_0.3D_IT12	PMDT4200	NLED15.6WGXGAG	UMA	N	SO2GBIII10	N250GB5.4KS	NSM8XS	3rd WiFi 1x2 BGN	3rd WiFi 1x2 BGN	N	N	0.3M DV
AS5738Z-423G25Mn	EME A	Middle East	LX.PAR0X.042	AS5738Z-423G25Mn EM VHP32ATME9 MC UMACbbM 2G+1G/250/6L/5R/ CB_bgn_0.3D_FR22	PMDT4200	NLED15.6WGXGAG	UMA	N	SO2GBIII10	N250GB5.4KS	NSM8XS	3rd WiFi 1x2 BGN	3rd WiFi 1x2 BGN	N	N	0.3M DV
AS5738Z-423G32Mn	AAP	India	LX.PAR0Y.010	AS5738Z-423G32Mn VHB32ATIN1 MC UMACbbM 2G+1G/320/6L/5R/ CB_bg_0.3D_EN12	PMDT4200	NLED15.6WGXGAG	UMA	N	SO2GBIII10	N320GB5.4KS	NSM8XS	3rd WiFi 1x2 BGN	3rd WiFi 1x2 BGN	BT 2.0	N	0.3M DV
AS5738Z-423G50Mn	AAP	India	LX.PAR0Y.009	AS5738Z-423G50Mn VHB32ATIN1 MC UMACbbM 2G+1G/500_L/BT/6L/5R/ CB_bg_0.3D_EN12	PMDT4200	NLED15.6WGXGAG	UMA	N	SO2GBIII10	N500GB5.4KS	NSM8XS	3rd WiFi 1x2 BGN	3rd WiFi 1x2 BGN	BT 2.0	N	0.3M DV
AS5738Z-422G32Mn	AAP	India	LX.PAR0Y.012	AS5738Z-422G32Mn VHB32ATIN1 MC UMACbbM 1*2G/320/6L/5R/ CB_bg_0.3D_EN12	PMDT4200	NLED15.6WGXGAG	UMA	N	SO2GBIII10/N	N320GB5.4KS	NSM8XS	3rd WiFi 1x2 BGN	3rd WiFi 1x2 BGN	BT 2.0	N	0.3M DV

Model	RO	Country	Acer Part No	Description	CPU	LCD	VGA Chip	VRAM 1	Memory 1/ Memory 2	HDD 1(GB)	ODD	WLAN	WLAN1	Bluetooth	Finger- print	Camera
AS5738Z-423G50Mn	AAP	India	LX.PAR0X.045	AS5738Z-423G50Mn VHP32ATIN1 MC UMACbbM 2G+1G/500_L/6L/5R/ CB_bg_0.3D_EN12	PMDT4200	NLED15.6WGXGAG	UMA	N	SO2GBIII10	N500GB5.4KS	NSM8XS	3rd WiFi 1x2 BGN	3rd WiFi 1x2 BGN	BT 2.0	N	0.3M DV
AS5738Z-423G32Mn	AAP	India	LX.PAR0X.046	AS5738Z-423G32Mn VHP32ATIN1 MC UMACbbM 2G+1G/320/6L/5R/ CB_bg_0.3D_EN12	PMDT4200	NLED15.6WGXGAG	UMA	N	SO2GBIII10	N320GB5.4KS	NSM8XS	3rd WiFi 1x2 BGN	3rd WiFi 1x2 BGN	BT 2.0	N	0.3M DV
AS5738Z-422G25Mn	AAP	India	LX.PAR0X.047	AS5738Z-422G25Mn VHP32ATIN1 MC UMACbbM 1*2G/250/6L/5R/ CB_bg_0.3D_EN12	PMDT4200	NLED15.6WGXGAG	UMA	N	SO2GBIII10/N	N250GB5.4KS	NSM8XS	3rd WiFi 1x2 BGN	3rd WiFi 1x2 BGN	BT 2.0	N	0.3M DV
AS5738Z-423G25Mn	EME A	Middle East	LX.PAR0X.041	AS5738Z-423G25Mn EM VHP32ATME6 MC UMACbbM 2G+1G/250/6L/5R/ CB_bgn_0.3D_EN15	PMDT4200	NLED15.6WGXGAG	UMA	N	SO2GBIII10	N250GB5.4KS	NSM8XS	3rd WiFi 1x2 BGN	3rd WiFi 1x2 BGN	N	N	0.3M DV
AS5738Z-421G16Mn	AAP	India	LX.PAR0X.049	AS5738Z-421G16Mn VHP32ATIN1 MC UMACbbM 1*1G/160/6L/5R/ CB_bg_0.3D_EN12	PMDT4200	NLED15.6WGXGAG	UMA	N	SO1GBIII10/N	N160GB5.4KS	NSM8XS	3rd WiFi 1x2 BGN	3rd WiFi 1x2 BGN	BT 2.0	N	0.3M DV
AS5738Z-422G32Mn	AAP	India	LX.PAR0X.048	AS5738Z-422G32Mn VHP32ATIN1 MC UMACbbM 1*2G/320/6L/5R/ CB_bg_0.3D_EN12	PMDT4200	NLED15.6WGXGAG	UMA	N	SO2GBIII10/N	N320GB5.4KS	NSM8XS	3rd WiFi 1x2 BGN	3rd WiFi 1x2 BGN	BT 2.0	N	0.3M DV
AS5738Z-423G25Mn	EME A	Denmark	LX.PAR0X.020	AS5738Z-423G25Mn VHP32ATDK2 MC UMACbbM 2G+1G/250/6L/5R/ CB_bgn_0.3D_ENS3	PMDT4200	NLED15.6WGXGAG	UMA	N	SO2GBIII10	N250GB5.4KS	NSM8XS	3rd WiFi 1x2 BGN	3rd WiFi 1x2 BGN	N	N	0.3M DV
AS5738Z-423G25Mn	EME A	Austria	LX.PAR0X.010	AS5738Z-423G25Mn VHP32ATAT1 MC UMACbbM 2G+1G/250/6L/5R/ CB_bgn_0.3D_DE11	PMDT4200	NLED15.6WGXGAG	UMA	N	SO2GBIII10	N250GB5.4KS	NSM8XS	3rd WiFi 1x2 BGN	3rd WiFi 1x2 BGN	N	N	0.3M DV
AS5738Z-423G25Mn	EME A	Germany	LX.PAR0X.022	AS5738Z-423G25Mn VHP32ATDE1 MC UMACbbM 2G+1G/250/6L/5R/ CB_bgn_0.3D_DE13	PMDT4200	NLED15.6WGXGAG	UMA	N	SO2GBIII10	N250GB5.4KS	NSM8XS	3rd WiFi 1x2 BGN	3rd WiFi 1x2 BGN	N	N	0.3M DV
AS5738Z-423G25Mn	EME A	France	LX.PAR0X.021	AS5738Z-423G25Mn VHP32ATFR1 MC UMACbbM 2G+1G/250/6L/5R/ CB_bgn_0.3D_FR23	PMDT4200	NLED15.6WGXGAG	UMA	N	SO2GBIII10	N250GB5.4KS	NSM8XS	3rd WiFi 1x2 BGN	3rd WiFi 1x2 BGN	N	N	0.3M DV
AS5738Z-423G25Mn	EME A	Middle East	LX.PAR0X.028	AS5738Z-423G25Mn EM VHP32ATME3 MC UMACbbM 2G+1G/250/6L/5R/ CB_bgn_0.3D_FR23	PMDT4200	NLED15.6WGXGAG	UMA	N	SO2GBIII10	N250GB5.4KS	NSM8XS	3rd WiFi 1x2 BGN	3rd WiFi 1x2 BGN	N	N	0.3M DV
AS5738Z-423G25Mn	EME A	South Africa	LX.PAR0X.026	AS5738Z-423G25Mn EM VHP32ATZA1 MC UMACbbM 2G+1G/250/6L/5R/ CB_bgn_0.3D_FR23	PMDT4200	NLED15.6WGXGAG	UMA	N	SO2GBIII10	N250GB5.4KS	NSM8XS	3rd WiFi 1x2 BGN	3rd WiFi 1x2 BGN	N	N	0.3M DV
AS5738Z-423G25Mn	EME A	UK	LX.PAR0X.030	AS5738Z-423G25Mn VHP32ATGB1 MC UMACbbM 2G+1G/250/6L/5R/ CB_bgn_0.3D_EN14	PMDT4200	NLED15.6WGXGAG	UMA	N	SO2GBIII10	N250GB5.4KS	NSM8XS	3rd WiFi 1x2 BGN	3rd WiFi 1x2 BGN	N	N	0.3M DV
AS5738Z-423G25Mn	EME A	Eastern Europe	LX.PAR0X.005	AS5738Z-423G25Mn VHP32ATEU7 MC UMACbbM 2G+1G/250/6L/5R/ CB_bgn_0.3D_SL11	PMDT4200	NLED15.6WGXGAG	UMA	N	SO2GBIII10	N250GB5.4KS	NSM8XS	3rd WiFi 1x2 BGN	3rd WiFi 1x2 BGN	N	N	0.3M DV
AS5738Z-423G25Mn	EME A	Eastern Europe	LX.PAR0X.032	AS5738Z-423G25Mn VHP32ATEU7 MC UMACbbM 2G+1G/250/6L/5R/ CB_bgn_0.3D_ENR2	PMDT4200	NLED15.6WGXGAG	UMA	N	SO2GBIII10	N250GB5.4KS	NSM8XS	3rd WiFi 1x2 BGN	3rd WiFi 1x2 BGN	N	N	0.3M DV
AS5738Z-423G25Mn	EME A	Norway	LX.PAR0X.011	AS5738Z-423G25Mn VHP32ATNO1 MC UMACbbM 2G+1G/250/6L/5R/ CB_bgn_0.3D_NO12	PMDT4200	NLED15.6WGXGAG	UMA	N	SO2GBIII10	N250GB5.4KS	NSM8XS	3rd WiFi 1x2 BGN	3rd WiFi 1x2 BGN	N	N	0.3M DV
AS5738Z-423G25Mn	EME A	Sweden	LX.PAR0X.007	AS5738Z-423G25Mn VHP32ATSE1 MC UMACbbM 2G+1G/250/6L/5R/ CB_bgn_0.3D_FI13	PMDT4200	NLED15.6WGXGAG	UMA	N	SO2GBIII10	N250GB5.4KS	NSM8XS	3rd WiFi 1x2 BGN	3rd WiFi 1x2 BGN	N	N	0.3M DV
AS5738Z-423G25Mn	EME A	Finland	LX.PAR0X.036	AS5738Z-423G25Mn VHP32ATFI2 MC UMACbbM 2G+1G/250/6L/5R/ CB_bgn_0.3D_FI11	PMDT4200	NLED15.6WGXGAG	UMA	N	SO2GBIII10	N250GB5.4KS	NSM8XS	3rd WiFi 1x2 BGN	3rd WiFi 1x2 BGN	N	N	0.3M DV

Model	RO	Country	Acer Part No	Description	CPU	LCD	VGA Chip	VRAM 1	Memory 1/ Memory 2	HDD 1(GB)	ODD	WLAN	WLAN1	Bluetooth	Finger- print	Camera
AS5738Z-423G25Mn	EME A	Eastern Europe	LX.PAR0X.035	AS5738Z-423G25Mn VHP32ATEU4 MC UMACbbM 2G+1G/250/6L/5R/ CB_bgn_0.3D_SV22	PMDT4200	NLED15.6WGXGAG	UMA	N	SO2GBIII10	N250GB5.4KS	NSM8XS	3rd WiFi 1x2 BGN	3rd WiFi 1x2 BGN	N	N	0.3M DV
AS5738Z-423G25Mn	EME A	Hungary	LX.PAR0X.037	AS5738Z-423G25Mn VHP32ATHU1 MC UMACbbM 2G+1G/250/6L/5R/ CB_bgn_0.3D_HU13	PMDT4200	NLED15.6WGXGAG	UMA	N	SO2GBIII10	N250GB5.4KS	NSM8XS	3rd WiFi 1x2 BGN	3rd WiFi 1x2 BGN	N	N	0.3M DV
AS5738Z-423G25Mn	EME A	Turkey	LX.PAR0X.015	AS5738Z-423G25Mn EM VHP32ATTR1 MC UMACbbM 2G+1G/250/6L/5R/ CB_bgn_0.3D_TR33	PMDT4200	NLED15.6WGXGAG	UMA	N	SO2GBIII10	N250GB5.4KS	NSM8XS	3rd WiFi 1x2 BGN	3rd WiFi 1x2 BGN	N	N	0.3M DV
AS5738Z-423G25Mn	EME A	Greece	LX.PAR0X.040	AS5738Z-423G25Mn VHP32ATGR1 MC UMACbbM 2G+1G/250/6L/5R/ CB_bgn_0.3D_EL32	PMDT4200	NLED15.6WGXGAG	UMA	N	SO2GBIII10	N250GB5.4KS	NSM8XS	3rd WiFi 1x2 BGN	3rd WiFi 1x2 BGN	N	N	0.3M DV
AS5738Z-423G25Mn	EME A	Spain	LX.PAR0X.039	AS5738Z-423G25Mn VHP32ATES1 MC UMACbbM 2G+1G/250/6L/5R/ CB_bgn_0.3D_ES22	PMDT4200	NLED15.6WGXGAG	UMA	N	SO2GBIII10	N250GB5.4KS	NSM8XS	3rd WiFi 1x2 BGN	3rd WiFi 1x2 BGN	N	N	0.3M DV
AS5738Z-423G25Mn	EME A	Czech	LX.PAR0X.006	AS5738Z-423G25Mn VHP32ATCZ2 MC UMACbbM 2G+1G/250/6L/5R/ CB_bgn_0.3D_SK12	PMDT4200	NLED15.6WGXGAG	UMA	N	SO2GBIII10	N250GB5.4KS	NSM8XS	3rd WiFi 1x2 BGN	3rd WiFi 1x2 BGN	N	N	0.3M DV
AS5738Z-423G25Mn	EME A	Middle East	LX.PAR0X.014	AS5738Z-423G25Mn EM VHP32ATME2 MC UMACbbM 2G+1G/250/6L/5R/ CB_bgn_0.3D_AR23	PMDT4200	NLED15.6WGXGAG	UMA	N	SO2GBIII10	N250GB5.4KS	NSM8XS	3rd WiFi 1x2 BGN	3rd WiFi 1x2 BGN	N	N	0.3M DV
AS5738Z-423G25Mn	EME A	Middle East	LX.PAR0X.027	AS5738Z-423G25Mn EM VHP32ATME2 MC UMACbbM 2G+1G/250/6L/5R/ CB_bgn_0.3D_AR13	PMDT4200	NLED15.6WGXGAG	UMA	N	SO2GBIII10	N250GB5.4KS	NSM8XS	3rd WiFi 1x2 BGN	3rd WiFi 1x2 BGN	N	N	0.3M DV
AS5738Z-423G25Mn	EME A	Middle East	LX.PAR0X.023	AS5738Z-423G25Mn EM VHP32ATME2 MC UMACbbM 2G+1G/250/6L/5R/ CB_bgn_0.3D_EN15	PMDT4200	NLED15.6WGXGAG	UMA	N	SO2GBIII10	N250GB5.4KS	NSM8XS	3rd WiFi 1x2 BGN	3rd WiFi 1x2 BGN	N	N	0.3M DV
AS5738Z-423G25Mn	EME A	Luxembourg	LX.PAR0X.012	AS5738Z-423G25Mn VHP32ATLU3 MC UMACbbM 2G+1G/250/6L/5R/ CB_bgn_0.3D_IT41	PMDT4200	NLED15.6WGXGAG	UMA	N	SO2GBIII10	N250GB5.4KS	NSM8XS	3rd WiFi 1x2 BGN	3rd WiFi 1x2 BGN	N	N	0.3M DV
AS5738Z-423G25Mn	EME A	Switzerland	LX.PAR0X.017	AS5738Z-423G25Mn VHP32ATCH1 MC UMACbbM 2G+1G/250/6L/5R/ CB_bgn_0.3D_IT42	PMDT4200	NLED15.6WGXGAG	UMA	N	SO2GBIII10	N250GB5.4KS	NSM8XS	3rd WiFi 1x2 BGN	3rd WiFi 1x2 BGN	N	N	0.3M DV
AS5738Z-423G25Mi	EME A	Russia	LX.PAR0X.009	AS5738Z-423G25Mi VHP32ATRU1 MC UMACbbM 2G+1G/250/6L/5R/ CB_bgn_0.3D_RU11	PMDT4200	NLED15.6WGXGAG	UMA	N	SO2GBIII10	N250GB5.4KS	NSM8XS	3rd WiFi 1x2 BGN	3rd WiFi BG	N	N	0.3M DV
AS5738Z-423G25Mi	EME A	Ukraine	LX.PAR0X.018	AS5738Z-423G25Mi VHP32ATUK1 MC UMACbbM 2G+1G/250/6L/5R/ CB_bgn_0.3D_RU11	PMDT4200	NLED15.6WGXGAG	UMA	N	SO2GBIII10	N250GB5.4KS	NSM8XS	3rd WiFi 1x2 BGN	3rd WiFi BG	N	N	0.3M DV
AS5738Z-423G25Mn	EME A	Middle East	LX.PAR0X.024	AS5738Z-423G25Mn EM VHP32ATME4 MC UMACbbM 2G+1G/250/6L/5R/ CB_bgn_0.3D_EN11	PMDT4200	NLED15.6WGXGAG	UMA	N	SO2GBIII10	N250GB5.4KS	NSM8XS	3rd WiFi 1x2 BGN	3rd WiFi 1x2 BGN	N	N	0.3M DV
AS5738Z-423G25Mn	EME A	Eastern Europe	LX.PAR0X.034	AS5738Z-423G25Mn VHP32ATEU3 MC UMACbbM 2G+1G/250/6L/5R/ CB_bgn_0.3D_RU23	PMDT4200	NLED15.6WGXGAG	UMA	N	SO2GBIII10	N250GB5.4KS	NSM8XS	3rd WiFi 1x2 BGN	3rd WiFi 1x2 BGN	N	N	0.3M DV
AS5738Z-423G25Mn	EME A	Belgium	LX.PAR0X.013	AS5738Z-423G25Mn VHP32ATBE1 MC UMACbbM 2G+1G/250/6L/5R/ CB_bgn_0.3D_NL13	PMDT4200	NLED15.6WGXGAG	UMA	N	SO2GBIII10	N250GB5.4KS	NSM8XS	3rd WiFi 1x2 BGN	3rd WiFi 1x2 BGN	N	N	0.3M DV
AS5738Z-423G25Mn	EME A	Portugal	LX.PAR0X.038	AS5738Z-423G25Mn VHP32ATPT1 MC UMACbbM 2G+1G/250/6L/5R/ CB_bgn_0.3D_PT12	PMDT4200	NLED15.6WGXGAG	UMA	N	SO2GBIII10	N250GB5.4KS	NSM8XS	3rd WiFi 1x2 BGN	3rd WiFi 1x2 BGN	N	N	0.3M DV
AS5738Z-423G25Mn	EME A	Holland	LX.PAR0X.029	AS5738Z-423G25Mn VHP32ATNL1 MC UMACbbM 2G+1G/250/6L/5R/ CB_bgn_0.3D_NL12	PMDT4200	NLED15.6WGXGAG	UMA	N	SO2GBIII10	N250GB5.4KS	NSM8XS	3rd WiFi 1x2 BGN	3rd WiFi 1x2 BGN	N	N	0.3M DV

Model	RO	Country	Acer Part No	Description	CPU	LCD	VGA Chip	VRAM 1	Memory 1/ Memory 2	HDD 1(GB)	ODD	WLAN	WLAN1	Bluetooth	Finger- print	Camera
AS5738Z-423G25Mn	EME A	Poland	LX.PAR0X.016	AS5738Z-423G25Mn VHP32ATPL1 MC UMACbbm 2G+1G/250/6L/5R/ CB_bgn_0.3D_PL11	PMDT420 0	NLED15.6WXGAG	UMA	N	SO2GBIII10	N250GB5.4KS	NSM8XS	3rd WiFi 1x2 BGN	3rd WiFi 1x2 BGN	N	N	0.3M DV
AS5738Z-423G25Mn	EME A	South Africa	LX.PAR0X.025	AS5738Z-423G25Mn EM VHP32ATZA2 MC UMACbbm 2G+1G/250/6L/5R/ CB_bgn_0.3D_EN16	PMDT420 0	NLED15.6WXGAG	UMA	N	SO2GBIII10	N250GB5.4KS	NSM8XS	3rd WiFi 1x2 BGN	3rd WiFi 1x2 BGN	N	N	0.3M DV
AS5738Z-423G25Mn	EME A	Eastern Europe	LX.PAR0X.033	AS5738Z-423G25Mn VHP32ATEU5 MC UMACbbm 2G+1G/250/6L/5R/ CB_bgn_0.3D_PL13	PMDT420 0	NLED15.6WXGAG	UMA	N	SO2GBIII10	N250GB5.4KS	NSM8XS	3rd WiFi 1x2 BGN	3rd WiFi 1x2 BGN	N	N	0.3M DV
AS5738Z-423G25Mn	EME A	Eastern Europe	LX.PAR0X.031	AS5738Z-423G25Mn VHP32ATEU5 MC UMACbbm 2G+1G/250/6L/5R/ CB_bgn_0.3D_RO12	PMDT420 0	NLED15.6WXGAG	UMA	N	SO2GBIII10	N250GB5.4KS	NSM8XS	3rd WiFi 1x2 BGN	3rd WiFi 1x2 BGN	N	N	0.3M DV
AS5738Z-423G25Mn	EME A	Denmark	LX.PAR0X.019	AS5738Z-423G25Mn VHP32ATDK1 MC UMACbbm 2G+1G/250/6L/5R/ CB_bgn_0.3D_NO13	PMDT420 0	NLED15.6WXGAG	UMA	N	SO2GBIII10	N250GB5.4KS	NSM8XS	3rd WiFi 1x2 BGN	3rd WiFi 1x2 BGN	N	N	0.3M DV
AS5738Z-423G25Mn	EME A	Norway	LX.PAR0X.008	AS5738Z-423G25Mn VHP32ATNO3 MC UMACbbm 2G+1G/250/6L/5R/ CB_bgn_0.3D_ENS3	PMDT420 0	NLED15.6WXGAG	UMA	N	SO2GBIII10	N250GB5.4KS	NSM8XS	3rd WiFi 1x2 BGN	3rd WiFi 1x2 BGN	N	N	0.3M DV
AS5738Z-421G16Mn	AAP	Australia/ New Zealand	LX.PAR0Y.006	AS5738Z-421G16Mn VHB32ATAU1 MC UMACbbm 1*1G/160/BT/6L/5R/ CB_bgn_0.3D_EN12	PMDT420 0	NLED15.6WXGAG	UMA	N	SO1GBIII10/N	N160GB5.4KS	NSM8XS	3rd WiFi 1x2 BGN	3rd WiFi 1x2 BGN	BT 2.0	N	0.3M DV
AS5738Z-421G16Mn	AAP	Thailand	LX.PAR0Y.002	AS5738Z-421G16Mn EM VHB32ATTH1 MC UMACbbm 1*1G/160/BT/6L/5R/ CB_bgn_0.3D_TH22	PMDT420 0	NLED15.6WXGAG	UMA	N	SO1GBIII10/N	N160GB5.4KS	NSM8XS	3rd WiFi 1x2 BGN	3rd WiFi 1x2 BGN	BT 2.0	N	0.3M DV
AS5738Z-421G16Mn	AAP	Vietnam	LX.PAR0Y.001	AS5738Z-421G16Mn EM VHB32ATVN1 MC UMACbbm 1*1G/160/BT/6L/5R/ CB_bgn_0.3D_EN13	PMDT420 0	NLED15.6WXGAG	UMA	N	SO1GBIII10/N	N160GB5.4KS	NSM8XS	3rd WiFi 1x2 BGN	3rd WiFi 1x2 BGN	BT 2.0	N	0.3M DV
AS5738Z-421G16Mn	AAP	Malaysia	LX.PAR0Y.004	AS5738Z-421G16Mn EM VHB32ATMY1 MC UMACbbm 1*1G/160/BT/6L/5R/ CB_bgn_0.3D_EN14	PMDT420 0	NLED15.6WXGAG	UMA	N	SO1GBIII10/N	N160GB5.4KS	NSM8XS	3rd WiFi 1x2 BGN	3rd WiFi 1x2 BGN	BT 2.0	N	0.3M DV
AS5738Z-421G16Mn	AAP	Philippines	LX.PAR0Y.003	AS5738Z-421G16Mn EM VHB32ATPH1 MC UMACbbm 1*1G/160/BT/6L/5R/ CB_bgn_0.3D_EN14	PMDT420 0	NLED15.6WXGAG	UMA	N	SO1GBIII10/N	N160GB5.4KS	NSM8XS	3rd WiFi 1x2 BGN	3rd WiFi 1x2 BGN	BT 2.0	N	0.3M DV
AS5738Z-421G16Mn	AAP	Singapore	LX.PAR0Y.007	AS5738Z-421G16Mn VHB32ATSG1 MC UMACbbm 1*1G/160/BT/6L/5R/ CB_bgn_0.3D_EN12	PMDT420 0	NLED15.6WXGAG	UMA	N	SO1GBIII10/N	N160GB5.4KS	NSM8XS	3rd WiFi 1x2 BGN	3rd WiFi 1x2 BGN	BT 2.0	N	0.3M DV
AS5738Z-421G16Mn	AAP	Indonesia	LX.PAR0Y.005	AS5738Z-421G16Mn EM VHB32ATID1 MC UMACbbm 1*1G/160/BT/6L/5R/ CB_bgn_0.3D_ID24	PMDT420 0	NLED15.6WXGAG	UMA	N	SO1GBIII10/N	N160GB5.4KS	NSM8XS	3rd WiFi 1x2 BGN	3rd WiFi 1x2 BGN	BT 2.0	N	0.3M DV
AS5738Z-422G25Mn	PA	ACLA- Spanish	LX.PAR0X.001	AS5738Z-422G25Mn VHP32ATEA3 MC UMACbbm 2*1G/250/6L/CB_bgn_0.3D_ES21	PMDT420 0	NLED15.6WXGAG	UMA	N	SO1GBIII10	N250GB5.4KS	NSM8XS	3rd WiFi 1x2 BGN	3rd WiFi 1x2 BGN	N	N	0.3M DV
AS5738Z-422G25Mn	PA	ACLA- Portuguese	LX.PAR0X.002	AS5738Z-422G25Mn VHP32ATXC2 MC UMACbbm 2*1G/250/6L/CB_bgn_0.3D_XC22	PMDT420 0	NLED15.6WXGAG	UMA	N	SO1GBIII10	N250GB5.4KS	NSM8XS	3rd WiFi 1x2 BGN	3rd WiFi 1x2 BGN	N	N	0.3M DV
AS5738Z-422G25Mn	PA	Canada	LX.PAR0X.003	AS5738Z-422G25Mn VHP32ATCA1 MC UMACbbm 2*1G/250/6L/CB_bgn_0.3D_FR11	PMDT420 0	NLED15.6WXGAG	UMA	N	SO1GBIII10	N250GB5.4KS	NSM8XS	3rd WiFi 1x2 BGN	3rd WiFi 1x2 BGN	N	N	0.3M DV
AS5738Z-423G16Mn	EME A	UK	LX.PAQ0Y.007	AS5738Z-423G16Mn VHB32ATGB1 MC UMAbb 2G+1G/160/6L/5R/CB_bgn_EN14	PMDT420 0	NLED15.6WXGAG	UMA	N	SO2GBIII10	N160GB5.4KS	NSM8XS	3rd WiFi 1x2 BGN	3rd WiFi 1x2 BGN	N	N	N
AS5738Z-424G16Mn	EME A	UK	LX.PAQ0Y.006	AS5738Z-424G16Mn VHB32ATGB1 MC UMAbb 2*2G/160/6L/5R/CB_bgn_EN14	PMDT420 0	NLED15.6WXGAG	UMA	N	SO2GBIII10	N160GB5.4KS	NSM8XS	3rd WiFi 1x2 BGN	3rd WiFi 1x2 BGN	N	N	N
AS5738Z-422G25Mn	PA	USA	LX.PAQ0Y.004	AS5738Z-422G25Mn VHB32ATUS1 MC UMAbbm 2*1G/250/6L/CB_bgn_EN34	PMDT420 0	NLED15.6WXGAG	UMA	N	SO1GBIII10	N250GB5.4KS	NSM8XS	3rd WiFi 1x2 BGN	3rd WiFi 1x2 BGN	N	N	N
AS5738Z-422G25Mn	PA	ACLA- Portuguese	LX.PAQ0Y.005	AS5738Z-422G25Mn EM VHB32ATXC1 MC UMAbbm 2*1G/250/6L/CB_bgn_XC22	PMDT420 0	NLED15.6WXGAG	UMA	N	SO1GBIII10	N250GB5.4KS	NSM8XS	3rd WiFi 1x2 BGN	3rd WiFi 1x2 BGN	N	N	N
AS5738Z-422G25Mn	PA	Canada	LX.PAQ0Y.003	AS5738Z-422G25Mn VHB32ATCA2 MC UMAbbm 2*1G/250/6L/CB_bgn_FR31	PMDT420 0	NLED15.6WXGAG	UMA	N	SO1GBIII10	N250GB5.4KS	NSM8XS	3rd WiFi 1x2 BGN	3rd WiFi 1x2 BGN	N	N	N

Model	RO	Country	Acer Part No	Description	CPU	LCD	VGA Chip	VRAM 1	Memory 1/ Memory 2	HDD 1(GB)	ODD	WLAN	WLAN1	Bluetooth	Finger- print	Camera
AS5738Z-422G25Mn	PA	ACLA-Spanish	LX.PA00Y.001	AS5738Z-422G25Mn EM VHB32ATEA1 MC UMABbb 2*1G/250/6L/CB_bgn_ES22	PMDT4200	NLED15.6WXGAG	UMA	N	SO1GBIII10	N250GB5.4KS	NSM8XS	3rd WiFi 1x2 BGN	3rd WiFi 1x2 BGN	N	N	N
AS5738Z-422G25Mn	PA	USA	LX.PA00Y.002	AS5738Z-422G25Mn VHB32ATUS1 MC UMABbb 2*1G/250/6L/CB_bgn_EN32	PMDT4200	NLED15.6WXGAG	UMA	N	SO1GBIII10	N250GB5.4KS	NSM8XS	3rd WiFi 1x2 BGN	3rd WiFi 1x2 BGN	N	N	N
AS5738-644G25Mn	EME A	UK	LX.PAJ0X.053	AS5738-644G25Mn VHP32ATGB1 MC UMACbb 2*2G/250/6L/5R/CB_n2_0.3D_EN14	C2DT6400	NLED15.6WXGAG	UMA	N	SO2GBIII10	N250GB5.4KS	NSM8XS	SP1x2MM W	SP1x2MM W	N	N	0.3M DV
AS5738-643G32Mn	EME A	Poland	LX.PAJ0X.052	AS5738-643G32Mn VHP32ATPL1 MC UMACbb 1G+2G/320/6L/5R/CB_n2_0.3D_PL11	C2DT6400	NLED15.6WXGAG	UMA	N	SO1GBIII10	N320GB5.4KS	NSM8XS	SP1x2MM W	SP1x2MM W	N	N	0.3M DV
AS5738-642G32Mn	EME A	Middle East	LX.PAJ0C.001	AS5738-642G32Mn LINPUSAME2 UMACbb 1*2G/320/B7/6L/5R/CB_n2_0.3D_EN13	C2DT6400	NLED15.6WXGAG	UMA	N	SO2GBIII10/N	N320GB5.4KS	NSM8XS	SP1x2MM W	SP1x2MM W	BT 2.0	N	0.3M DV
AS5738-642G25Mn	PA	ACLA-Portuguese	LX.PAJ0X.049	AS5738-642G25Mn EM VHP32ATXC2 MC UMACbb 2*1G/250/6L/CB_n2_0.3D_XC21	C2DT6400	NLED15.6WXGAG	UMA	N	SO1GBIII10	N250GB5.4KS	NSM8XS	SP1x2MM W	SP1x2MM W	N	N	0.3M DV
AS5738-643G32Mn	PA	ACLA-Spanish	LX.PAJ0X.041	AS5738-643G32Mn EM VHP32ATEA1 MC UMACbb 2G+1G/320/6L/CB_n2_0.3D_ES22	C2DT6400	NLED15.6WXGAG	UMA	N	SO2GBIII10	N320GB5.4KS	NSM8XS	SP1x2MM W	SP1x2MM W	N	N	0.3M DV
AS5738-643G25Mn	PA	ACLA-Spanish	LX.PAJ0X.044	AS5738-643G25Mn EM VHP32ATEA1 MC UMACbb 2G+1G/250/6L/CB_n2_0.3D_ES22	C2DT6400	NLED15.6WXGAG	UMA	N	SO2GBIII10	N250GB5.4KS	NSM8XS	SP1x2MM W	SP1x2MM W	N	N	0.3M DV
AS5738-643G25Mn	PA	ACLA-Spanish	LX.PAJ0X.045	AS5738-643G25Mn EM VHP32ATEA3 MC UMACbb 2G+1G/250/6L/CB_n2_0.3D_ES22	C2DT6400	NLED15.6WXGAG	UMA	N	SO2GBIII10	N250GB5.4KS	NSM8XS	SP1x2MM W	SP1x2MM W	N	N	0.3M DV
AS5738-642G25Mn	PA	ACLA-Spanish	LX.PAJ0X.047	AS5738-642G25Mn EM VHP32ATEA1 MC UMACbb 2*1G/250/6L/CB_n2_0.3D_ES22	C2DT6400	NLED15.6WXGAG	UMA	N	SO1GBIII10	N250GB5.4KS	NSM8XS	SP1x2MM W	SP1x2MM W	N	N	0.3M DV
AS5738-643G25Mn	PA	ACLA-Portuguese	LX.PAJ0X.046	AS5738-643G25Mn EM VHP32ATXC2 MC UMACbb 2G+1G/250/6L/CB_n2_0.3D_XC21	C2DT6400	NLED15.6WXGAG	UMA	N	SO2GBIII10	N250GB5.4KS	NSM8XS	SP1x2MM W	SP1x2MM W	N	N	0.3M DV
AS5738-643G32Bn	PA	ACLA-Portuguese	LX.PAJ0X.042	AS5738-643G32Bn EM VHP32ATXC1 MC UMACbb 2G+1G/320/6L/CB_n2_0.3D_XC22	C2DT6400	NLED15.6WXGAG	UMA	N	SO2GBIII10	N320GB5.4KS	NBDCB4 XS	SP1x2MM W	SP1x2MM W	N	N	0.3M DV
AS5738-643G32Mn	PA	ACLA-Portuguese	LX.PAJ0X.043	AS5738-643G32Mn EM VHP32ATXC2 MC UMACbb 2G+1G/320/6L/CB_n2_0.3D_XC21	C2DT6400	NLED15.6WXGAG	UMA	N	SO2GBIII10	N320GB5.4KS	NSM8XS	SP1x2MM W	SP1x2MM W	N	N	0.3M DV
AS5738-642G25Mn	PA	ACLA-Spanish	LX.PAJ0X.048	AS5738-642G25Mn EM VHP32ATEA3 MC UMACbb 2*1G/250/6L/CB_n2_0.3D_ES22	C2DT6400	NLED15.6WXGAG	UMA	N	SO1GBIII10	N250GB5.4KS	NSM8XS	SP1x2MM W	SP1x2MM W	N	N	0.3M DV
AS5738-643G25Mn	EME A	Middle East	LX.PAJ0X.017	AS5738-643G25Mn EM VHP32ATME3 MC UMACbb 2G+1G/250/6L/CB_n2_0.3D_FR23	C2DT6400	NLED15.6WXGAG	UMA	N	SO2GBIII10	N250GB5.4KS	NSM8XS	SP1x2MM W	SP1x2MM W	N	N	0.3M DV
AS5738-643G25Mn	EME A	Turkey	LX.PAJ0X.005	AS5738-643G25Mn EM VHP32ATTR1 MC UMACbb 2G+1G/250/6L/CB_n2_0.3D_TR33	C2DT6400	NLED15.6WXGAG	UMA	N	SO2GBIII10	N250GB5.4KS	NSM8XS	SP1x2MM W	SP1x2MM W	N	N	0.3M DV
AS5738-643G25Mn	EME A	Middle East	LX.PAJ0X.019	AS5738-643G25Mn EM VHP32ATME4 MC UMACbb 2G+1G/250/6L/CB_n2_0.3D_EN11	C2DT6400	NLED15.6WXGAG	UMA	N	SO2GBIII10	N250GB5.4KS	NSM8XS	SP1x2MM W	SP1x2MM W	N	N	0.3M DV
AS5738-643G25Mn	EME A	Middle East	LX.PAJ0X.040	AS5738-643G25Mn EM VHP32ATME6 MC UMACbb 2G+1G/250/6L/CB_n2_0.3D_EN15	C2DT6400	NLED15.6WXGAG	UMA	N	SO2GBIII10	N250GB5.4KS	NSM8XS	SP1x2MM W	SP1x2MM W	N	N	0.3M DV
AS5738-643G32Mn	PA	ACLA-Spanish	LX.PAJ0X.050	AS5738-643G32Mn EM VHP32ATEA3 MC UMACbb 2G+1G/320/6L/CB_n2_0.3D_ES22	C2DT6400	NLED15.6WXGAG	UMA	N	SO2GBIII10	N320GB5.4KS	NSM8XS	SP1x2MM W	SP1x2MM W	N	N	0.3M DV
AS5738-643G25Mn	EME A	Switzerland	LX.PAJ0X.003	AS5738-643G25Mn VHP32ATCH1 MC UMACbb 2G+1G/250/6L/CB_n2_0.3D_IT42	C2DT6400	NLED15.6WXGAG	UMA	N	SO2GBIII10	N250GB5.4KS	NSM8XS	SP1x2MM W	SP1x2MM W	N	N	0.3M DV
AS5738-643G25Mn	EME A	Poland	LX.PAJ0X.004	AS5738-643G25Mn VHP32ATPL1 MC UMACbb 2G+1G/250/6L/CB_n2_0.3D_PL11	C2DT6400	NLED15.6WXGAG	UMA	N	SO2GBIII10	N250GB5.4KS	NSM8XS	SP1x2MM W	SP1x2MM W	N	N	0.3M DV
AS5738-643G25Mn	EME A	UK	LX.PAJ0X.001	AS5738-643G25Mn VHP32ATGB1 MC UMACbb 2G+1G/250/6L/CB_n2_0.3D_EN14	C2DT6400	NLED15.6WXGAG	UMA	N	SO2GBIII10	N250GB5.4KS	NSM8XS	SP1x2MM W	SP1x2MM W	N	N	0.3M DV
AS5738-643G25Mn	EME A	Middle East	LX.PAJ0X.018	AS5738-643G25Mn EM VHP32ATME2 MC UMACbb 2G+1G/250/6L/CB_n2_0.3D_AR13	C2DT6400	NLED15.6WXGAG	UMA	N	SO2GBIII10	N250GB5.4KS	NSM8XS	SP1x2MM W	SP1x2MM W	N	N	0.3M DV
AS5738-643G25Mn	EME A	Middle East	LX.PAJ0X.006	AS5738-643G25Mn EM VHP32ATME2 MC UMACbb 2G+1G/250/6L/CB_n2_0.3D_AR23	C2DT6400	NLED15.6WXGAG	UMA	N	SO2GBIII10	N250GB5.4KS	NSM8XS	SP1x2MM W	SP1x2MM W	N	N	0.3M DV
AS5738-643G25Mn	EME A	Middle East	LX.PAJ0X.020	AS5738-643G25Mn EM VHP32ATME2 MC UMACbb 2G+1G/250/6L/CB_n2_0.3D_EN15	C2DT6400	NLED15.6WXGAG	UMA	N	SO2GBIII10	N250GB5.4KS	NSM8XS	SP1x2MM W	SP1x2MM W	N	N	0.3M DV



Model	RO	Country	Acer Part No	Description	CPU	LCD	VGA Chip	VRAM 1	Memory 1/ Memory 2	HDD 1(GB)	ODD	WLAN	WLAN1	Bluetooth	Finger- print	Camera
AS5738-643G25Mi	EME A	Ukraine	LX.PAJ0X.002	AS5738-643G25Mi VHP32ATUK1 MC UMACbb 2G+1G/250/6L/CB_abg_0.3D_RU11	C2DT6400	NLED15.6WXGAG	UMA	N	SO2GBIII10	N250GB5.4KS	NSM8XS	SP1x2MM W	SP1x2MA BG	N	N	0.3M DV
AS5738-643G25Mn	EME A	Italy	LX.PAJ0X.039	AS5738-643G25Mn VHP32ATIT1 MC UMACbb 2G+1G/250/6L/CB_n2_0.3D_IT12	C2DT6400	NLED15.6WXGAG	UMA	N	SO2GBIII10	N250GB5.4KS	NSM8XS	SP1x2MM W	SP1x2MM W	N	N	0.3M DV
AS5738-643G25Mn	EME A	Greece	LX.PAJ0X.038	AS5738-643G25Mn VHP32ATGR1 MC UMACbb 2G+1G/250/6L/CB_n2_0.3D_EL32	C2DT6400	NLED15.6WXGAG	UMA	N	SO2GBIII10	N250GB5.4KS	NSM8XS	SP1x2MM W	SP1x2MM W	N	N	0.3M DV
AS5738-643G25Mn	EME A	Israel	LX.PAJ0X.008	AS5738-643G25Mn VHP32ATIL1 MC UMACbb 2G+1G/250/6L/CB_n2_0.3D_HE12	C2DT6400	NLED15.6WXGAG	UMA	N	SO2GBIII10	N250GB5.4KS	NSM8XS	SP1x2MM W	SP1x2MM W	N	N	0.3M DV
AS5738-643G25Mn	EME A	Middle East	LX.PAJ0X.007	AS5738-643G25Mn EM VHP32ATME9 MC UMACbb 2G+1G/250/6L/CB_n2_0.3D_FR22	C2DT6400	NLED15.6WXGAG	UMA	N	SO2GBIII10	N250GB5.4KS	NSM8XS	SP1x2MM W	SP1x2MM W	N	N	0.3M DV
AS5738-643G25Mn	EME A	Spain	LX.PAJ0X.009	AS5738-643G25Mn VHP32ATES1 MC UMACbb 2G+1G/250/6L/CB_n2_0.3D_ES22	C2DT6400	NLED15.6WXGAG	UMA	N	SO2GBIII10	N250GB5.4KS	NSM8XS	SP1x2MM W	SP1x2MM W	N	N	0.3M DV
AS5738-643G25Mn	EME A	Hungary	LX.PAJ0X.037	AS5738-643G25Mn VHP32ATHU1 MC UMACbb 2G+1G/250/6L/CB_n2_0.3D_HU13	C2DT6400	NLED15.6WXGAG	UMA	N	SO2GBIII10	N250GB5.4KS	NSM8XS	SP1x2MM W	SP1x2MM W	N	N	0.3M DV
AS5738-643G25Mn	EME A	Eastern Europe	LX.PAJ0X.012	AS5738-643G25Mn VHP32ATEU7 MC UMACbb 2G+1G/250/6L/CB_n2_0.3D_ENR2	C2DT6400	NLED15.6WXGAG	UMA	N	SO2GBIII10	N250GB5.4KS	NSM8XS	SP1x2MM W	SP1x2MM W	N	N	0.3M DV
AS5738-643G25Mn	EME A	Eastern Europe	LX.PAJ0X.013	AS5738-643G25Mn VHP32ATEU5 MC UMACbb 2G+1G/250/6L/CB_n2_0.3D_PL13	C2DT6400	NLED15.6WXGAG	UMA	N	SO2GBIII10	N250GB5.4KS	NSM8XS	SP1x2MM W	SP1x2MM W	N	N	0.3M DV
AS5738-643G25Mn	EME A	Eastern Europe	LX.PAJ0X.011	AS5738-643G25Mn VHP32ATEU5 MC UMACbb 2G+1G/250/6L/CB_n2_0.3D_RO12	C2DT6400	NLED15.6WXGAG	UMA	N	SO2GBIII10	N250GB5.4KS	NSM8XS	SP1x2MM W	SP1x2MM W	N	N	0.3M DV
AS5738-643G25Mn	EME A	Eastern Europe	LX.PAJ0X.014	AS5738-643G25Mn VHP32ATEU3 MC UMACbb 2G+1G/250/6L/CB_n2_0.3D_RU23	C2DT6400	NLED15.6WXGAG	UMA	N	SO2GBIII10	N250GB5.4KS	NSM8XS	SP1x2MM W	SP1x2MM W	N	N	0.3M DV
AS5738-643G25Mn	EME A	Portugal	LX.PAJ0X.021	AS5738-643G25Mn VHP32ATPT1 MC UMACbb 2G+1G/250/6L/CB_n2_0.3D_PT12	C2DT6400	NLED15.6WXGAG	UMA	N	SO2GBIII10	N250GB5.4KS	NSM8XS	SP1x2MM W	SP1x2MM W	N	N	0.3M DV
AS5738-643G25Mn	EME A	Eastern Europe	LX.PAJ0X.015	AS5738-643G25Mn VHP32ATEU4 MC UMACbb 2G+1G/250/6L/CB_n2_0.3D_SV22	C2DT6400	NLED15.6WXGAG	UMA	N	SO2GBIII10	N250GB5.4KS	NSM8XS	SP1x2MM W	SP1x2MM W	N	N	0.3M DV
AS5738-643G25Mn	EME A	Finland	LX.PAJ0X.016	AS5738-643G25Mn VHP32ATF12 MC UMACbb 2G+1G/250/6L/CB_n2_0.3D_FI11	C2DT6400	NLED15.6WXGAG	UMA	N	SO2GBIII10	N250GB5.4KS	NSM8XS	SP1x2MM W	SP1x2MM W	N	N	0.3M DV
AS5738-643G25Mn	EME A	Sweden	LX.PAJ0X.036	AS5738-643G25Mn VHP32ATSE1 MC UMACbb 2G+1G/250/6L/CB_n2_0.3D_FI13	C2DT6400	NLED15.6WXGAG	UMA	N	SO2GBIII10	N250GB5.4KS	NSM8XS	SP1x2MM W	SP1x2MM W	N	N	0.3M DV
AS5738-643G25Mn	EME A	Austria	LX.PAJ0X.023	AS5738-643G25Mn VHP32ATAT1 MC UMACbb 2G+1G/250/6L/CB_n2_0.3D_DE11	C2DT6400	NLED15.6WXGAG	UMA	N	SO2GBIII10	N250GB5.4KS	NSM8XS	SP1x2MM W	SP1x2MM W	N	N	0.3M DV
AS5738-643G25Mn	EME A	Czech	LX.PAJ0X.022	AS5738-643G25Mn VHP32ATCZ2 MC UMACbb 2G+1G/250/6L/CB_n2_0.3D_SK12	C2DT6400	NLED15.6WXGAG	UMA	N	SO2GBIII10	N250GB5.4KS	NSM8XS	SP1x2MM W	SP1x2MM W	N	N	0.3M DV
AS5738-643G25Mi	EME A	Russia	LX.PAJ0X.035	AS5738-643G25Mi VHP32ATRU1 MC UMACbb 2G+1G/250/6L/CB_abg_0.3D_RU11	C2DT6400	NLED15.6WXGAG	UMA	N	SO2GBIII10	N250GB5.4KS	NSM8XS	SP1x2MM W	SP1x2MA BG	N	N	0.3M DV
AS5738-643G25Mn	EME A	Norway	LX.PAJ0X.024	AS5738-643G25Mn VHP32ATNO3 MC UMACbb 2G+1G/250/6L/CB_n2_0.3D_ENS3	C2DT6400	NLED15.6WXGAG	UMA	N	SO2GBIII10	N250GB5.4KS	NSM8XS	SP1x2MM W	SP1x2MM W	N	N	0.3M DV
AS5738-643G25Mn	EME A	Belgium	LX.PAJ0X.032	AS5738-643G25Mn VHP32ATBE1 MC UMACbb 2G+1G/250/6L/CB_n2_0.3D_NL13	C2DT6400	NLED15.6WXGAG	UMA	N	SO2GBIII10	N250GB5.4KS	NSM8XS	SP1x2MM W	SP1x2MM W	N	N	0.3M DV
AS5738-643G25Mn	EME A	Eastern Europe	LX.PAJ0X.010	AS5738-643G25Mn VHP32ATEU7 MC UMACbb 2G+1G/250/6L/CB_n2_0.3D_SL11	C2DT6400	NLED15.6WXGAG	UMA	N	SO2GBIII10	N250GB5.4KS	NSM8XS	SP1x2MM W	SP1x2MM W	N	N	0.3M DV
AS5738-643G25Mn	EME A	Luxembourg	LX.PAJ0X.025	AS5738-643G25Mn VHP32ATLU3 MC UMACbb 2G+1G/250/6L/CB_n2_0.3D_IT41	C2DT6400	NLED15.6WXGAG	UMA	N	SO2GBIII10	N250GB5.4KS	NSM8XS	SP1x2MM W	SP1x2MM W	N	N	0.3M DV
AS5738-643G25Mn	EME A	Norway	LX.PAJ0X.034	AS5738-643G25Mn VHP32ATNO1 MC UMACbb 2G+1G/250/6L/CB_n2_0.3D_NO12	C2DT6400	NLED15.6WXGAG	UMA	N	SO2GBIII10	N250GB5.4KS	NSM8XS	SP1x2MM W	SP1x2MM W	N	N	0.3M DV
AS5738-643G25Mn	EME A	Holland	LX.PAJ0X.033	AS5738-643G25Mn VHP32ATNL1 MC UMACbb 2G+1G/250/6L/CB_n2_0.3D_NL12	C2DT6400	NLED15.6WXGAG	UMA	N	SO2GBIII10	N250GB5.4KS	NSM8XS	SP1x2MM W	SP1x2MM W	N	N	0.3M DV
AS5738-643G25Mn	EME A	Germany	LX.PAJ0X.031	AS5738-643G25Mn VHP32ATDE1 MC UMACbb 2G+1G/250/6L/CB_n2_0.3D_DE13	C2DT6400	NLED15.6WXGAG	UMA	N	SO2GBIII10	N250GB5.4KS	NSM8XS	SP1x2MM W	SP1x2MM W	N	N	0.3M DV

Model	RO	Country	Acer Part No	Description	CPU	LCD	VGA Chip	VRAM 1	Memory 1/ Memory 2	HDD 1(GB)	ODD	WLAN	WLAN1	Bluetooth	Finger- print	Camera
AS5738-643G25Mn	EME A	South Africa	LX.PAJ0X.027	AS5738-643G25Mn EM VHP32ATZA1 MC UMACbb 2G+1G/250/6L/CB_n2_0.3D_FR23	C2DT6400	NLED15.6WXGAG	UMA	N	SO2GBIII10	N250GB5.4KS	NSM8XS	SP1x2MM W	SP1x2MM W	N	N	0.3M DV
AS5738-643G25Mn	EME A	France	LX.PAJ0X.030	AS5738-643G25Mn VHP32ATFR1 MC UMACbb 2G+1G/250/6L/CB_n2_0.3D_FR23	C2DT6400	NLED15.6WXGAG	UMA	N	SO2GBIII10	N250GB5.4KS	NSM8XS	SP1x2MM W	SP1x2MM W	N	N	0.3M DV
AS5738-642G32Bn	PA	USA	LX.PAJ0Y.007	AS5738-642G32Bn VHB32ATUS1 MC UMACbb 2*1G/320/6L/CB_n2_0.3D_EN34	C2DT6400	NLED15.6WXGAG	UMA	N	SO1GBIII10	N320GB5.4KS	NBDCB4 XS	SP1x2MM W	SP1x2MM W	N	N	0.3M DV
AS5738-642G25Mn	PA	USA	LX.PAJ0Y.003	AS5738-642G25Mn VHB32ATF1 MC UMACbb 2*1G/250/6L/CB_n2_0.3D_EN34	C2DT6400	NLED15.6WXGAG	UMA	N	SO1GBIII10	N250GB5.4KS	NSM8XS	SP1x2MM W	SP1x2MM W	N	N	0.3M DV
AS5738-642G25Mn	PA	ACLA-Portuguese	LX.PAJ0Y.001	AS5738-642G25Mn EM VHB32ATXC1 MC UMACbb 2*1G/250/6L/CB_n2_0.3D_XC22	C2DT6400	NLED15.6WXGAG	UMA	N	SO1GBIII10	N250GB5.4KS	NSM8XS	SP1x2MM W	SP1x2MM W	N	N	0.3M DV
AS5738-642G25Mn	PA	Canada	LX.PAJ0Y.004	AS5738-642G25Mn VHB32ATCA1 MC UMACbb 2*1G/250/6L/CB_n2_0.3D_FR11	C2DT6400	NLED15.6WXGAG	UMA	N	SO1GBIII10	N250GB5.4KS	NSM8XS	SP1x2MM W	SP1x2MM W	N	N	0.3M DV
AS5738-642G25Mn	PA	Canada	LX.PAJ0Y.005	AS5738-642G25Mn VHB32ATCA1 MC UMACbb 2*1G/250/6L/CB_n2_0.3D_FR12	C2DT6400	NLED15.6WXGAG	UMA	N	SO1GBIII10	N250GB5.4KS	NSM8XS	SP1x2MM W	SP1x2MM W	N	N	0.3M DV
AS5738-642G32Bn	PA	Canada	LX.PAJ0Y.008	AS5738-642G32Bn VHB32ATCA1 MC UMACbb 2*1G/320/6L/CB_n2_0.3D_FR12	C2DT6400	NLED15.6WXGAG	UMA	N	SO1GBIII10	N320GB5.4KS	NBDCB4 XS	SP1x2MM W	SP1x2MM W	N	N	0.3M DV
AS5738-643G25Mn	EME A	Denmark	LX.PAJ0X.029	AS5738-643G25Mn VHP32ATDK2 MC UMACbb 2G+1G/250/6L/CB_n2_0.3D_ENS3	C2DT6400	NLED15.6WXGAG	UMA	N	SO2GBIII10	N250GB5.4KS	NSM8XS	SP1x2MM W	SP1x2MM W	N	N	0.3M DV
AS5738-643G25Mn	EME A	Denmark	LX.PAJ0X.028	AS5738-643G25Mn VHP32ATDK1 MC UMACbb 2G+1G/250/6L/CB_n2_0.3D_NO13	C2DT6400	NLED15.6WXGAG	UMA	N	SO2GBIII10	N250GB5.4KS	NSM8XS	SP1x2MM W	SP1x2MM W	N	N	0.3M DV
AS5738-642G25Mn	PA	USA	LX.PAJ0Y.002	AS5738-642G25Mn VHB32ATUS1 MC UMACbb 2*1G/250/6L/CB_n2_0.3D_EN32	C2DT6400	NLED15.6WXGAG	UMA	N	SO1GBIII10	N250GB5.4KS	NSM8XS	SP1x2MM W	SP1x2MM W	N	N	0.3M DV
AS5738-642G32Bn	PA	USA	LX.PAJ0Y.006	AS5738-642G32Bn VHB32ATUS1 MC UMACbb 2*1G/320/6L/CB_n2_0.3D_EN32	C2DT6400	NLED15.6WXGAG	UMA	N	SO1GBIII10	N320GB5.4KS	NBDCB4 XS	SP1x2MM W	SP1x2MM W	N	N	0.3M DV
AS5738-643G25Mn	EME A	South Africa	LX.PAJ0X.026	AS5738-643G25Mn EM VHP32ATZA2 MC UMACbb 2G+1G/250/6L/CB_n2_0.3D_EN16	C2DT6400	NLED15.6WXGAG	UMA	N	SO2GBIII10	N250GB5.4KS	NSM8XS	SP1x2MM W	SP1x2MM W	N	N	0.3M DV
AS5738-642G16Mn	PA	USA	LX.PAC0Y.003	AS5738-642G16Mn VHB32ATUS1 MC UMAbb 2*1G/160/6L/CB_n2_EN32	C2DT6400	NLED15.6WXGAG	UMA	N	SO1GBIII10	N160GB5.4KS	NSM8XS	SP1x2MM W	SP1x2MM W	N	N	N
AS5738-642G16Mn	PA	USA	LX.PAC0Y.005	AS5738-642G16Mn VHB32ATUS1 MC UMAbb 2*1G/160/6L/CB_n2_EN34	C2DT6400	NLED15.6WXGAG	UMA	N	SO1GBIII10	N160GB5.4KS	NSM8XS	SP1x2MM W	SP1x2MM W	N	N	N
AS5738-642G16Mn	PA	USA	LX.PAC0Y.002	AS5738-642G16Mn VHB32ATUS1 MC UMAbb 2*1G/160/6L/CB_n2_EN33	C2DT6400	NLED15.6WXGAG	UMA	N	SO1GBIII10	N160GB5.4KS	NSM8XS	SP1x2MM W	SP1x2MM W	N	N	N
AS5738-642G16Mn	PA	ACLA-Portuguese	LX.PAC0Y.001	AS5738-642G16Mn VHB32ATXC1 MC UMAbb 2*1G/160/6L/CB_n2_XC21	C2DT6400	NLED15.6WXGAG	UMA	N	SO1GBIII10	N160GB5.4KS	NSM8XS	SP1x2MM W	SP1x2MM W	N	N	N
AS5738-642G16Mn	PA	Canada	LX.PAC0Y.004	AS5738-642G16Mn VHB32ATCA2 MC UMAbb 2*1G/160/6L/CB_n2_FR32	C2DT6400	NLED15.6WXGAG	UMA	N	SO1GBIII10	N160GB5.4KS	NSM8XS	SP1x2MM W	SP1x2MM W	N	N	N

# Aspire 5536/5536G/5236 Series

**NOTE:** All models have following common specifications: Card reader (5-in-1), Battery (6CELL2.2), Camera (0.3M DV),

Model	RO	Country	Acer Part No	Description	CPU	LCD	VGA Chip	VRAM 1	Memory 1	Memory 2	HDD 1(GB)	ODD	Wireless LAN	Wireless LAN1	Blue-tooth	Finger Print
AS5236-422G16Mn	AAP	Australia /New Zealand	LX.PCX0Y.004	AS5236-422G16Mn VHB32ATAU1 MC UMACbb 1*2G/160/6L/5R/ CB_bgn_0.3D_HG_EN12	SMPSI4225W	NLED15.6 WXGAG	UMA	N	SO2GBIi6	N	N160GB5.4KS	NSM8XS	3rd WiFi 1x2 BGN	3rd WiFi 1x2 BGN	N	N
AS5236-421G16Mn	AAP	Australia /New Zealand	LX.PCX0Y.003	AS5236-421G16Mn VHB32ATAU1 MC UMACbb 1*1G/160/6L/5R/ CB_bgn_0.3D_HG_EN12	SMPSI4225W	NLED15.6 WXGAG	UMA	N	SO1GBIi6	N	N160GB5.4KS	NSM8XS	3rd WiFi 1x2 BGN	3rd WiFi 1x2 BGN	N	N
AS5236-422G25Mn	AAP	Australia /New Zealand	LX.PCX0Y.002	AS5236-422G25Mn VHB32ATAU1 MC UMACbb 1*2G/250/6L/5R/ CB_bgn_0.3D_HG_EN12	SMPSI4225W	NLED15.6 WXGAG	UMA	N	SO2GBIi6	N	N250GB5.4KS	NSM8XS	3rd WiFi 1x2 BGN	3rd WiFi 1x2 BGN	N	N
AS5236-421G25Mn	AAP	Australia /New Zealand	LX.PCX0Y.001	AS5236-421G25Mn VHB32ATAU1 MC UMACbb 1*1G/250/6L/5R/ CB_bgn_0.3D_HG_EN12	SMPSI4225W	NLED15.6 WXGAG	UMA	N	SO1GBIi6	N	N250GB5.4KS	NSM8XS	3rd WiFi 1x2 BGN	3rd WiFi 1x2 BGN	N	N
AS5536G-722G32Mn	WW	WW	S2.P420X.001	AS5536G-722G32Mn VHP32AWW1 MC M92XT512CF 1*2G/320/BT/ 6L/CB_bgn_FP_0.3D_EN11	ATRM72	NLED15.6 WXGAG	M92XT	512M- DDR2(64*16*4)	SO2GBIi6	N	N320GB5.4KS	NSM8XS	3rd WiFi 1x2 BGN	3rd WiFi 1x2 BGN	BT 2.0	AES1610
AS5536G-644G32Mn	AAP	Australia /New Zealand	LX.PB10X.010	AS5536G-644G32Mn VHP32ATAU1 MC M92XT512CFbb 2*2G/320/ BT/6L/5R/ CB_bgn_FP_0.3D_EN12	AAQL64	NLED15.6 WXGAG	M92XT	512M- DDR2(64*16*4)	SO2GBIi6	SO2GBIi6	N320GB5.4KS	NSM8XS	3rd WiFi 1x2 BGN	3rd WiFi 1x2 BGN	BT 2.0	AES1610
AS5536G-643G32Mn	AAP	Australia /New Zealand	LX.PB10X.009	AS5536G-643G32Mn VHP32ATAU1 MC M92XT512CFbb 2G+1G/ 320/BT/6L/5R/ CB_bgn_FP_0.3D_EN12	AAQL64	NLED15.6 WXGAG	M92XT	512M- DDR2(64*16*4)	SO2GBIi6	SO1GBIi6	N320GB5.4KS	NSM8XS	3rd WiFi 1x2 BGN	3rd WiFi 1x2 BGN	BT 2.0	AES1610
AS5536G-742G32Mn	AAP	Singapore	LX.PB10X.008	AS5536G-742G32Mn VHP32ATSG1 MC M92XT512CFbbM 1*2G/ 320/BT/6L/5R/ CB_bgn_FP_0.3D_EN12	ATRM74	NLED15.6 WXGAG	M92XT	512M- DDR2(64*16*4)	SO2GBIi6	N	N320GB5.4KS	NSM8XS	3rd WiFi 1x2 BGN	3rd WiFi 1x2 BGN	BT 2.0	AES1610
AS5536G-642G25Mn	AAP	Australia /New Zealand	LX.PB10X.007	AS5536G-642G25Mn VHP32ATAU1 MC M92XT512CFbbM 1*2G/ 250/6L/5R/ CB_bgn_FP_0.3D_EN12	AAQL64	NLED15.6 WXGAG	M92XT	512M- DDR2(64*16*4)	SO2GBIi6	N	N250GB5.4KS	NSM8XS	3rd WiFi 1x2 BGN	3rd WiFi 1x2 BGN	N	AES1610
AS5536G-722G32Mn	AAP	Australia /New Zealand	LX.PB10X.006	AS5536G-722G32Mn VHP32ATAU1 MC M92XT512CFbbM 1*2G/ 320/BT/6L/5R/ CB_bgn_FP_0.3D_EN12	ATRM72	NLED15.6 WXGAG	M92XT	512M- DDR2(64*16*4)	SO2GBIi6	N	N320GB5.4KS	NSM8XS	3rd WiFi 1x2 BGN	3rd WiFi 1x2 BGN	BT 2.0	AES1610
AS5536G-642G25Mn	AAP	Australia /New Zealand	LX.PB10X.005	AS5536G-642G25Mn VHP32ATAU1 MC M92XT512CFbbM 1*2G/ 250/BT/6L/5R/ CB_bgn_FP_0.3D_EN12	AAQL64	NLED15.6 WXGAG	M92XT	512M- DDR2(64*16*4)	SO2GBIi6	N	N250GB5.4KS	NSM8XS	3rd WiFi 1x2 BGN	3rd WiFi 1x2 BGN	BT 2.0	AES1610

Model	RO	Country	Acer Part No	Description	CPU	LCD	VGA Chip	VRAM 1	Memory 1	Memory 2	HDD 1(GB)	ODD	Wireless LAN	Wireless LAN1	Blue-tooth	Finger Print
AS5536G-724G32Mn	AAP	Australia /New Zealand	LX.PB10X.004	AS5536G-724G32Mn VHP32ATAU1 MC M92XT512CFbbM 2*2G/320/BT/6L/5R/ CB_bgn_FP_0.3D_EN12	ATRM72	NLED15.6 WXGAG	M92XT	512M-DDR2(64*16*4)	SO2GBII6	SO2GBII6	N320GB5.4KS	NSM8XS	3rd WiFi 1x2 BGN	3rd WiFi 1x2 BGN	BT 2.0	AES1610
AS5536G-744G50Mn	AAP	Australia /New Zealand	LX.PB10X.003	AS5536G-744G50Mn VHP32ATAU1 MC M92XT512CFbbM 2*2G/500_L/BT/6L/5R/ CB_bgn_FP_0.3D_EN12	ATRM74	NLED15.6 WXGAG	M92XT	512M-DDR2(64*16*4)	SO2GBII6	SO2GBII6	N500GB5.4KS	NSM8XS	3rd WiFi 1x2 BGN	3rd WiFi 1x2 BGN	BT 2.0	AES1610
AS5536G-642G32Mn	AAP	Australia /New Zealand	LX.PB10X.002	AS5536G-642G32Mn VHP32ATAU1 MC M92XT512CFbbM 1*2G/320/BT/6L/5R/ CB_bgn_FP_0.3D_EN12	AAQL64	NLED15.6 WXGAG	M92XT	512M-DDR2(64*16*4)	SO2GBII6	N	N320GB5.4KS	NSM8XS	3rd WiFi 1x2 BGN	3rd WiFi 1x2 BGN	BT 2.0	AES1610
AS5536G-741G32Mn	AAP	Philippines	LX.PB10Y.002	AS5536G-741G32Mn EM VHB32ATPH1 MC M92XT512CFbbM 1*1G/320/6L/5R/ CB_bg_FP_0.3D_EN14	ATRM74	NLED15.6 WXGAG	M92XT	512M-DDR2(64*16*4)	SO1GBII6	N	N320GB5.4KS	NSM8XS	3rd WiFi 1x2 BGN	3rd WiFi 1x2 BGN	N	AES1610
AS5536G-642G32Mn	CHINA	China	LX.PB10Y.001	AS5536G-642G32Mn VHB32ATCN1 MC M92XT512CFbbM 1*2G/320/6L/ CB_bgn_FP_0.3D_SC11	AAQL64	NLED15.6 WXGAG	M92XT	512M-DDR2(64*16*4)	SO2GBII6	N	N320GB5.4KS	NSM8XS	3rd WiFi 1x2 BGN	3rd WiFi 1x2 BGN	N	AES1610
AS5536G-744G50Bn	WW	WW	S2.PB10X.002	AS5536G-744G50Bn VHP32AWW1 MC M92XT512CFbbM 2*2G/500_L/BT/6L/ CB_bgn_FP_0.3D_EN11	ATRM74	N15.6WXGAG	M92XT	512M-DDR2(64*16*4)	SO2GBII6	SO2GBII6	N500GB5.4KS	NBDCB4XS	3rd WiFi 1x2 BGN	3rd WiFi 1x2 BGN	BT 2.0	AES1610
AS5536G-744G50Bn	WW	GCTWN	S2.PB10X.001	AS5536G-744G50Bn VHP32AWW1 MC M92XT512CFbbM 2*2G/500_L/BT/6L/ CB_bgn_FP_0.3D_ENX1	ATRM74	N15.6WXGAG	M92XT	512M-DDR2(64*16*4)	SO2GBII6	SO2GBII6	N500GB5.4KS	NBDCB4XS	3rd WiFi 1x2 BGN	3rd WiFi 1x2 BGN	BT 2.0	AES1610
AS5536G-644G32Mn	AAP	Australia /New Zealand	LX.PAZ0X.050	AS5536G-644G32Mn VHP32ATAU1 MC M92XT512Cbb 2*2G/320/6L/5R/CB_bgn_0.3D_EN12	AAQL64	NLED15.6 WXGAG	M92XT	512M-DDR2(64*16*4)	SO2GBII6	SO2GBII6	N320GB5.4KS	NSM8XS	3rd WiFi 1x2 BGN	3rd WiFi 1x2 BGN	N	N
AS5536G-643G50Mn	EMEA	Poland	LX.PAZ0C.001	AS5536G-643G50Mn LNPUSAPL1 M92XT512Cbb 2G+1G/500_L/BT/6L/5R/ CB_bgn_0.3D_EN41	AAQL64	NLED15.6 WXGAG	M92XT	512M-DDR2(64*16*4)	SO2GBII6	SO1GBII6	N500GB5.4KS	NSM8XS	3rd WiFi 1x2 BGN	3rd WiFi 1x2 BGN	BT 2.0	N
AS5536G-643G32Mn	EMEA	Poland	LX.PAZ0C.002	AS5536G-643G32Mn LNPUSAPL1 M92XT512Cbb 2G+1G/320/BT/6L/5R/ CB_bgn_0.3D_EN41	AAQL64	NLED15.6 WXGAG	M92XT	512M-DDR2(64*16*4)	SO2GBII6	SO1GBII6	N320GB5.4KS	NSM8XS	3rd WiFi 1x2 BGN	3rd WiFi 1x2 BGN	BT 2.0	N
AS5536G-644G25Mn	EMEA	France	LX.PAZ0X.049	AS5536G-644G25Mn VHP32ATFR1 MC M92XT512Cbb 2*2G/250/6L/5R/CB_bgn_0.3D_FR23	AAQL64	NLED15.6 WXGAG	M92XT	512M-DDR2(64*16*4)	SO2GBII6	SO2GBII6	N250GB5.4KS	NSM8XS	3rd WiFi 1x2 BGN	3rd WiFi 1x2 BGN	N	N
AS5536G-744G32Mn	EMEA	Turkey	LX.PAZ0X.024	AS5536G-744G32Mn EM VHP32ATTR1 MC M92XT512Cbb 2*2G/320/6L/5R/CB_bgn_0.3D_TR33	ATRM74	NLED15.6 WXGAG	M92XT	512M-DDR2(64*16*4)	SO2GBII6	SO2GBII6	N320GB5.4KS	NSM8XS	3rd WiFi 1x2 BGN	3rd WiFi 1x2 BGN	N	N

Model	RO	Country	Acer Part No	Description	CPU	LCD	VGA Chip	VRAM 1	Memory 1	Memory 2	HDD 1(GB)	ODD	Wireless LAN	Wireless LAN1	Blue-tooth	Finger Print
AS5536G-744G32Mn	EMEA	Switzerland	LX.PA20X.022	AS5536G-744G32Mn VHP32ATCH1 MC M92XT512Cbb 2*2G/320/6L/5R/CB_bgn_0.3D_IT42	ATRM74	NLED15.6 WXGAG	M92XT	512M-DDR2(64*16*4)	SO2GBII6	SO2GBII6	N320GB5.4KS	NSM8XS	3rd WiFi 1x2 BGN	3rd WiFi 1x2 BGN	N	N
AS5536G-744G32Mn	EMEA	Poland	LX.PA20X.023	AS5536G-744G32Mn VHP32ATPL1 MC M92XT512Cbb 2*2G/320/6L/5R/CB_bgn_0.3D_PL11	ATRM74	NLED15.6 WXGAG	M92XT	512M-DDR2(64*16*4)	SO2GBII6	SO2GBII6	N320GB5.4KS	NSM8XS	3rd WiFi 1x2 BGN	3rd WiFi 1x2 BGN	N	N
AS5536G-744G32Mn	EMEA	Ukraine	LX.PA20X.021	AS5536G-744G32Mn VHP32ATUK1 MC M92XT512Cbb 2*2G/320/6L/5R/CB_bgn_0.3D_RU11	ATRM74	NLED15.6 WXGAG	M92XT	512M-DDR2(64*16*4)	SO2GBII6	SO2GBII6	N320GB5.4KS	NSM8XS	3rd WiFi 1x2 BGN	3rd WiFi 1x2 BGN	N	N
AS5536G-744G32Mn	EMEA	South Africa	LX.PA20X.035	AS5536G-744G32Mn EM VHP32ATZA1 MC M92XT512Cbb 2*2G/320/6L/5R/CB_bgn_0.3D_FR23	ATRM74	NLED15.6 WXGAG	M92XT	512M-DDR2(64*16*4)	SO2GBII6	SO2GBII6	N320GB5.4KS	NSM8XS	3rd WiFi 1x2 BGN	3rd WiFi 1x2 BGN	N	N
AS5536G-744G32Mn	EMEA	Denmark	LX.PA20X.037	AS5536G-744G32Mn VHP32ATDK2 MC M92XT512Cbb 2*2G/320/6L/5R/CB_bgn_0.3D_ENS3	ATRM74	NLED15.6 WXGAG	M92XT	512M-DDR2(64*16*4)	SO2GBII6	SO2GBII6	N320GB5.4KS	NSM8XS	3rd WiFi 1x2 BGN	3rd WiFi 1x2 BGN	N	N
AS5536G-744G32Mn	EMEA	Germany	LX.PA20X.039	AS5536G-744G32Mn VHP32ATDE1 MC M92XT512Cbb 2*2G/320/6L/5R/CB_bgn_0.3D_DE13	ATRM74	NLED15.6 WXGAG	M92XT	512M-DDR2(64*16*4)	SO2GBII6	SO2GBII6	N320GB5.4KS	NSM8XS	3rd WiFi 1x2 BGN	3rd WiFi 1x2 BGN	N	N
AS5536G-744G32Mn	EMEA	Eastern Europe	LX.PA20X.045	AS5536G-744G32Mn VHP32ATEU7 MC M92XT512Cbb 2*2G/320/6L/5R/CB_bgn_0.3D_SL11	ATRM74	NLED15.6 WXGAG	M92XT	512M-DDR2(64*16*4)	SO2GBII6	SO2GBII6	N320GB5.4KS	NSM8XS	3rd WiFi 1x2 BGN	3rd WiFi 1x2 BGN	N	N
AS5536G-744G32Mn	EMEA	Czech	LX.PA20X.031	AS5536G-744G32Mn VHP32ATCZ2 MC M92XT512Cbb 2*2G/320/6L/5R/CB_bgn_0.3D_SK12	ATRM74	NLED15.6 WXGAG	M92XT	512M-DDR2(64*16*4)	SO2GBII6	SO2GBII6	N320GB5.4KS	NSM8XS	3rd WiFi 1x2 BGN	3rd WiFi 1x2 BGN	N	N
AS5536G-744G32Mn	EMEA	Sweden	LX.PA20X.044	AS5536G-744G32Mn VHP32ATSE1 MC M92XT512Cbb 2*2G/320/6L/5R/CB_bgn_0.3D_F113	ATRM74	NLED15.6 WXGAG	M92XT	512M-DDR2(64*16*4)	SO2GBII6	SO2GBII6	N320GB5.4KS	NSM8XS	3rd WiFi 1x2 BGN	3rd WiFi 1x2 BGN	N	N
AS5536G-744G32Mn	EMEA	Austria	LX.PA20X.032	AS5536G-744G32Mn VHP32ATAT1 MC M92XT512Cbb 2*2G/320/6L/5R/CB_bgn_0.3D_DE11	ATRM74	NLED15.6 WXGAG	M92XT	512M-DDR2(64*16*4)	SO2GBII6	SO2GBII6	N320GB5.4KS	NSM8XS	3rd WiFi 1x2 BGN	3rd WiFi 1x2 BGN	N	N
AS5536G-744G32Mn	EMEA	Russia	LX.PA20X.043	AS5536G-744G32Mn VHP32ATRU1 MC M92XT512Cbb 2*2G/320/6L/5R/CB_bgn_0.3D_RU11	ATRM74	NLED15.6 WXGAG	M92XT	512M-DDR2(64*16*4)	SO2GBII6	SO2GBII6	N320GB5.4KS	NSM8XS	3rd WiFi 1x2 BGN	3rd WiFi 1x2 BGN	N	N
AS5536G-744G32Mn	EMEA	Norway	LX.PA20X.033	AS5536G-744G32Mn VHP32ATNO1 MC M92XT512Cbb 2*2G/320/6L/5R/CB_bgn_0.3D_NO12	ATRM74	NLED15.6 WXGAG	M92XT	512M-DDR2(64*16*4)	SO2GBII6	SO2GBII6	N320GB5.4KS	NSM8XS	3rd WiFi 1x2 BGN	3rd WiFi 1x2 BGN	N	N
AS5536G-744G32Mn	EMEA	Luxembourg	LX.PA20X.042	AS5536G-744G32Mn VHP32ATLU3 MC M92XT512Cbb 2*2G/320/6L/5R/CB_bgn_0.3D_IT41	ATRM74	NLED15.6 WXGAG	M92XT	512M-DDR2(64*16*4)	SO2GBII6	SO2GBII6	N320GB5.4KS	NSM8XS	3rd WiFi 1x2 BGN	3rd WiFi 1x2 BGN	N	N
AS5536G-744G32Mn	EMEA	Holland	LX.PA20X.041	AS5536G-744G32Mn VHP32ATNL1 MC M92XT512Cbb 2*2G/320/6L/5R/CB_bgn_0.3D_NL12	ATRM74	NLED15.6 WXGAG	M92XT	512M-DDR2(64*16*4)	SO2GBII6	SO2GBII6	N320GB5.4KS	NSM8XS	3rd WiFi 1x2 BGN	3rd WiFi 1x2 BGN	N	N

Model	RO	Country	Acer Part No	Description	CPU	LCD	VGA Chip	VRAM 1	Memory 1	Memory 2	HDD 1(GB)	ODD	Wireless LAN	Wireless LAN1	Blue-tooth	Finger Print
AS5536G-744G32Mn	EMEA	Belgium	LX.PA20X.040	AS5536G-744G32Mn VHP32ATBE1 MC M92XT512Cbb 2*2G/320/ 6L/5R/CB_bgn_0.3D_NL13	ATRM74	NLED15.6 WXGAG	M92XT	512M- DDR2(64*16*4)	SO2GBII6	SO2GBII6	N320GB5.4KS	NSM8XS	3rd WiFi 1x2 BGN	3rd WiFi 1x2 BGN	N	N
AS5536G-744G32Mn	EMEA	Spain	LX.PA20X.025	AS5536G-744G32Mn VHP32ATES1 MC M92XT512Cbb 2*2G/320/ 6L/5R/CB_bgn_0.3D_ES22	ATRM74	NLED15.6 WXGAG	M92XT	512M- DDR2(64*16*4)	SO2GBII6	SO2GBII6	N320GB5.4KS	NSM8XS	3rd WiFi 1x2 BGN	3rd WiFi 1x2 BGN	N	N
AS5536G-744G32Mn	EMEA	Portugal	LX.PA20X.026	AS5536G-744G32Mn VHP32ATPT1 MC M92XT512Cbb 2*2G/320/ 6L/5R/CB_bgn_0.3D_PT12	ATRM74	NLED15.6 WXGAG	M92XT	512M- DDR2(64*16*4)	SO2GBII6	SO2GBII6	N320GB5.4KS	NSM8XS	3rd WiFi 1x2 BGN	3rd WiFi 1x2 BGN	N	N
AS5536G-744G32Mn	EMEA	Hungary	LX.PA20X.027	AS5536G-744G32Mn VHP32ATHU1 MC M92XT512Cbb 2*2G/320/ 6L/5R/CB_bgn_0.3D_HU13	ATRM74	NLED15.6 WXGAG	M92XT	512M- DDR2(64*16*4)	SO2GBII6	SO2GBII6	N320GB5.4KS	NSM8XS	3rd WiFi 1x2 BGN	3rd WiFi 1x2 BGN	N	N
AS5536G-744G32Mn	EMEA	Finland	LX.PA20X.048	AS5536G-744G32Mn VHP32ATFI2 MC M92XT512Cbb 2*2G/320/ 6L/5R/CB_bgn_0.3D_FI11	ATRM74	NLED15.6 WXGAG	M92XT	512M- DDR2(64*16*4)	SO2GBII6	SO2GBII6	N320GB5.4KS	NSM8XS	3rd WiFi 1x2 BGN	3rd WiFi 1x2 BGN	N	N
AS5536G-744G32Mn	EMEA	Eastern Europe	LX.PA20X.028	AS5536G-744G32Mn VHP32ATEU4 MC M92XT512Cbb 2*2G/320/ 6L/5R/CB_bgn_0.3D_SV22	ATRM74	NLED15.6 WXGAG	M92XT	512M- DDR2(64*16*4)	SO2GBII6	SO2GBII6	N320GB5.4KS	NSM8XS	3rd WiFi 1x2 BGN	3rd WiFi 1x2 BGN	N	N
AS5536G-744G32Mn	EMEA	Eastern Europe	LX.PA20X.047	AS5536G-744G32Mn VHP32ATEU3 MC M92XT512Cbb 2*2G/320/ 6L/5R/CB_bgn_0.3D_RU23	ATRM74	NLED15.6 WXGAG	M92XT	512M- DDR2(64*16*4)	SO2GBII6	SO2GBII6	N320GB5.4KS	NSM8XS	3rd WiFi 1x2 BGN	3rd WiFi 1x2 BGN	N	N
AS5536G-744G32Mn	EMEA	Eastern Europe	LX.PA20X.029	AS5536G-744G32Mn VHP32ATEU5 MC M92XT512Cbb 2*2G/320/ 6L/5R/CB_bgn_0.3D_PL13	ATRM74	NLED15.6 WXGAG	M92XT	512M- DDR2(64*16*4)	SO2GBII6	SO2GBII6	N320GB5.4KS	NSM8XS	3rd WiFi 1x2 BGN	3rd WiFi 1x2 BGN	N	N
AS5536G-744G32Mn	EMEA	Eastern Europe	LX.PA20X.046	AS5536G-744G32Mn VHP32ATEU7 MC M92XT512Cbb 2*2G/320/ 6L/5R/CB_bgn_0.3D_ENR2	ATRM74	NLED15.6 WXGAG	M92XT	512M- DDR2(64*16*4)	SO2GBII6	SO2GBII6	N320GB5.4KS	NSM8XS	3rd WiFi 1x2 BGN	3rd WiFi 1x2 BGN	N	N
AS5536G-744G32Mn	EMEA	Eastern Europe	LX.PA20X.030	AS5536G-744G32Mn VHP32ATEU5 MC M92XT512Cbb 2*2G/320/ 6L/5R/CB_bgn_0.3D_RO12	ATRM74	NLED15.6 WXGAG	M92XT	512M- DDR2(64*16*4)	SO2GBII6	SO2GBII6	N320GB5.4KS	NSM8XS	3rd WiFi 1x2 BGN	3rd WiFi 1x2 BGN	N	N
AS5536G-744G32Mn	EMEA	France	LX.PA20X.038	AS5536G-744G32Mn VHP32ATFR1 MC M92XT512Cbb 2*2G/320/ 6L/5R/CB_bgn_0.3D_FR23	ATRM74	NLED15.6 WXGAG	M92XT	512M- DDR2(64*16*4)	SO2GBII6	SO2GBII6	N320GB5.4KS	NSM8XS	3rd WiFi 1x2 BGN	3rd WiFi 1x2 BGN	N	N
AS5536G-744G32Mn	EMEA	Denmark	LX.PA20X.036	AS5536G-744G32Mn VHP32ATDK1 MC M92XT512Cbb 2*2G/320/ 6L/5R/CB_bgn_0.3D_NO13	ATRM74	NLED15.6 WXGAG	M92XT	512M- DDR2(64*16*4)	SO2GBII6	SO2GBII6	N320GB5.4KS	NSM8XS	3rd WiFi 1x2 BGN	3rd WiFi 1x2 BGN	N	N
AS5536G-744G32Mn	EMEA	South Africa	LX.PA20X.034	AS5536G-744G32Mn EM VHP32ATZA2 MC M92XT512Cbb 2*2G/320/ 6L/5R/CB_bgn_0.3D_EN16	ATRM74	NLED15.6 WXGAG	M92XT	512M- DDR2(64*16*4)	SO2GBII6	SO2GBII6	N320GB5.4KS	NSM8XS	3rd WiFi 1x2 BGN	3rd WiFi 1x2 BGN	N	N
AS5536G-744G32Mn	EMEA	Middle East	LX.PA20X.017	AS5536G-744G32Mn EM VHP32ATME2 MC M92XT512Cbb 2*2G/320/ 6L/5R/CB_bgn_0.3D_AR23	ATRM74	NLED15.6 WXGAG	M92XT	512M- DDR2(64*16*4)	SO2GBII6	SO2GBII6	N320GB5.4KS	NSM8XS	3rd WiFi 1x2 BGN	3rd WiFi 1x2 BGN	N	N

Model	RO	Country	Acer Part No	Description	CPU	LCD	VGA Chip	VRAM 1	Memory 1	Memory 2	HDD 1(GB)	ODD	Wireless LAN	Wireless LAN1	Blue-tooth	Finger Print
AS5536G-744G32Mn	EMEA	Israel	LX.PA20X.019	AS5536G-744G32Mn VHP32ATIL1 MC M92XT512Cbb 2*2G/320/6L/5R/CB_bgn_0.3D_HE12	ATRM74	NLED15.6 WXGAG	M92XT	512M-DDR2(64*16*4)	SO2GBII6	SO2GBII6	N320GB5.4KS	NSM8XS	3rd WiFi 1x2 BGN	3rd WiFi 1x2 BGN	N	N
AS5536G-744G32Mn	EMEA	Middle East	LX.PA20X.016	AS5536G-744G32Mn EM VHP32ATME9 MC M92XT512Cbb 2*2G/320/6L/5R/CB_bgn_0.3D_FR22	ATRM74	NLED15.6 WXGAG	M92XT	512M-DDR2(64*16*4)	SO2GBII6	SO2GBII6	N320GB5.4KS	NSM8XS	3rd WiFi 1x2 BGN	3rd WiFi 1x2 BGN	N	N
AS5536G-744G32Mn	EMEA	Middle East	LX.PA20X.014	AS5536G-744G32Mn EM VHP32ATME2 MC M92XT512Cbb 2*2G/320/6L/5R/CB_bgn_0.3D_EN15	ATRM74	NLED15.6 WXGAG	M92XT	512M-DDR2(64*16*4)	SO2GBII6	SO2GBII6	N320GB5.4KS	NSM8XS	3rd WiFi 1x2 BGN	3rd WiFi 1x2 BGN	N	N
AS5536G-744G32Mn	EMEA	Middle East	LX.PA20X.012	AS5536G-744G32Mn EM VHP32ATME2 MC M92XT512Cbb 2*2G/320/6L/5R/CB_bgn_0.3D_AR13	ATRM74	NLED15.6 WXGAG	M92XT	512M-DDR2(64*16*4)	SO2GBII6	SO2GBII6	N320GB5.4KS	NSM8XS	3rd WiFi 1x2 BGN	3rd WiFi 1x2 BGN	N	N
AS5536G-744G32Mn	EMEA	Middle East	LX.PA20X.011	AS5536G-744G32Mn EM VHP32ATME3 MC M92XT512Cbb 2*2G/320/6L/5R/CB_bgn_0.3D_FR23	ATRM74	NLED15.6 WXGAG	M92XT	512M-DDR2(64*16*4)	SO2GBII6	SO2GBII6	N320GB5.4KS	NSM8XS	3rd WiFi 1x2 BGN	3rd WiFi 1x2 BGN	N	N
AS5536G-744G32Mn	EMEA	Middle East	LX.PA20X.013	AS5536G-744G32Mn EM VHP32ATME4 MC M92XT512Cbb 2*2G/320/6L/5R/CB_bgn_0.3D_EN11	ATRM74	NLED15.6 WXGAG	M92XT	512M-DDR2(64*16*4)	SO2GBII6	SO2GBII6	N320GB5.4KS	NSM8XS	3rd WiFi 1x2 BGN	3rd WiFi 1x2 BGN	N	N
AS5536G-744G32Mn	EMEA	Middle East	LX.PA20X.015	AS5536G-744G32Mn EM VHP32ATME6 MC M92XT512Cbb 2*2G/320/6L/5R/CB_bgn_0.3D_EN15	ATRM74	NLED15.6 WXGAG	M92XT	512M-DDR2(64*16*4)	SO2GBII6	SO2GBII6	N320GB5.4KS	NSM8XS	3rd WiFi 1x2 BGN	3rd WiFi 1x2 BGN	N	N
AS5536G-744G32Mn	EMEA	Italy	LX.PA20X.018	AS5536G-744G32Mn VHP32ATIT1 MC M92XT512Cbb 2*2G/320/6L/5R/CB_bgn_0.3D_IT12	ATRM74	NLED15.6 WXGAG	M92XT	512M-DDR2(64*16*4)	SO2GBII6	SO2GBII6	N320GB5.4KS	NSM8XS	3rd WiFi 1x2 BGN	3rd WiFi 1x2 BGN	N	N
AS5536G-744G32Mn	EMEA	Greece	LX.PA20X.020	AS5536G-744G32Mn VHP32ATGR1 MC M92XT512Cbb 2*2G/320/6L/5R/CB_bgn_0.3D_EL32	ATRM74	NLED15.6 WXGAG	M92XT	512M-DDR2(64*16*4)	SO2GBII6	SO2GBII6	N320GB5.4KS	NSM8XS	3rd WiFi 1x2 BGN	3rd WiFi 1x2 BGN	N	N
AS5536G-743G32Mn	AAP	Singapore	LX.PA20X.010	AS5536G-743G32Mn VHP32ATSG1 MC M92XT512CbbM 2G+1G/320/BT/6L/5R/CB_bgn_0.3D_EN12	ATRM74	NLED15.6 WXGAG	M92XT	512M-DDR2(64*16*4)	SO2GBII6	SO1GBII6	N320GB5.4KS	NSM8XS	3rd WiFi 1x2 BGN	3rd WiFi 1x2 BGN	BT 2.0	N
AS5536G-744G50Mn	AAP	Singapore	LX.PA20X.007	AS5536G-744G50Mn VHP32ATSG1 MC M92XT512Cbbm 2*2G/500_L/BT/6L/5R/CB_bgn_0.3D_EN12	ATRM74	NLED15.6 WXGAG	M92XT	512M-DDR2(64*16*4)	SO2GBII6	SO2GBII6	N500GB5.4KS	NSM8XS	3rd WiFi 1x2 BGN	3rd WiFi 1x2 BGN	BT 2.0	N
AS5536G-744G32Mn	AAP	Singapore	LX.PA20X.009	AS5536G-744G32Mn VHP32ATSG1 MC M92XT512Cbbm 2*2G/320/BT/6L/5R/CB_bgn_0.3D_EN12	ATRM74	NLED15.6 WXGAG	M92XT	512M-DDR2(64*16*4)	SO2GBII6	SO2GBII6	N320GB5.4KS	NSM8XS	3rd WiFi 1x2 BGN	3rd WiFi 1x2 BGN	BT 2.0	N
AS5536G-743G50Mn	AAP	Singapore	LX.PA20X.008	AS5536G-743G50Mn VHP32ATSG1 MC M92XT512Cbbm 2G+1G/500_L/BT/6L/5R/CB_bgn_0.3D_EN12	ATRM74	NLED15.6 WXGAG	M92XT	512M-DDR2(64*16*4)	SO2GBII6	SO1GBII6	N500GB5.4KS	NSM8XS	3rd WiFi 1x2 BGN	3rd WiFi 1x2 BGN	BT 2.0	N

Model	RO	Country	Acer Part No	Description	CPU	LCD	VGA Chip	VRAM 1	Memory 1	Memory 2	HDD 1(GB)	ODD	Wireless LAN	Wireless LAN1	Blue-tooth	Finger Print
AS5536G-642G25Mn	AAP	Australia /New Zealand	LX.PAZ0X.006	AS5536G-642G25Mn VHP32ATAU1 MC M92XT512CbbM 1*2G/250/6L/5R/CB_bgn_0.3D_EN12	AAQL64	NLED15.6 WXGAG	M92XT	512M-DDR2(64*16*4)	SO2GBII6	N	N250GB5.4KS	NSM8XS	3rd WiFi 1x2 BGN	3rd WiFi 1x2 BGN	N	N
AS5536G-642G25Mn	AAP	Japan	LX.PAZ0X.005	AS5536G-642G25Mn VHP32AJP1 MC M92XT512CbbM 1*2G/250/6L/5R/CB_bgn_0.3D_JA11	AAQL64	NLED15.6 WXGAG	M92XT	512M-DDR2(64*16*4)	SO2GBII6	N	N250GB5.4KS	NSM8XS	3rd WiFi 1x2 BGN	3rd WiFi 1x2 BGN	N	N
AS5536G-741G32Mn	AAP	Philippines	LX.PAZ0Y.001	AS5536G-741G32Mn EM VHB32ATPH1 MC M92XT512CbbM 1*1G/320/BT/6L/5R/CB_bg_0.3D_EN14	ATRM74	NLED15.6 WXGAG	M92XT	512M-DDR2(64*16*4)	SO1GBII6	N	N320GB5.4KS	NSM8XS	3rd WiFi 1x2 BGN	3rd WiFi 1x2 BGN	BT 2.0	N
AS5536G-642G25Mn	AAP	Japan	LX.PAZ0X.004	AS5536G-642G25Mn VHP32AJP1 MC M92XT512CbbM 2*1G/250/BT/6L/5R/CB_bgn_0.3D_JA11_CV2	AAQL64	NLED15.6 WXGAG	M92XT	512M-DDR2(64*16*4)	SO1GBII6	SO1GBII6	N250GB5.4KS	NSM8XS	3rd WiFi 1x2 BGN	3rd WiFi 1x2 BGN	BT 2.0	N
AS5536G-642G25Mn	AAP	Japan	LX.PAZ0X.003	AS5536G-642G25Mn VHP32ARJP1 MC M92XT512CbbM 2*1G/250/BT/6L/5R/CB_bgn_0.3D_JA11_CV2F	AAQL64	NLED15.6 WXGAG	M92XT	512M-DDR2(64*16*4)	SO1GBII6	SO1GBII6	N250GB5.4KS	NSM8XS	3rd WiFi 1x2 BGN	3rd WiFi 1x2 BGN	BT 2.0	N
AS5536G-744G32Mn	EMEA	UK	LX.PAZ0X.002	AS5536G-744G32Mn VHP32ATGB1 MC M92XT512CbbM 2*2G/320/6L/5R/CB_bgn_0.3D_EN14	ATRM74	NLED15.6 WXGAG	M92XT	512M-DDR2(64*16*4)	SO2GBII6	SO2GBII6	N320GB5.4KS	NSM8XS	3rd WiFi 1x2 BGN	3rd WiFi 1x2 BGN	N	N
AS5536G-644G50Mn	EMEA	Spain	LX.PAZ0X.001	AS5536G-644G50Mn VHP32ATES1 MC M92XT512CbbM 2*2G/500_L/6L/5R/CB_bgn_0.3D_ES22	AAQL64	NLED15.6 WXGAG	M92XT	512M-DDR2(64*16*4)	SO2GBII6	SO2GBII6	N500GB5.4KS	NSM8XS	3rd WiFi 1x2 BGN	3rd WiFi 1x2 BGN	N	N
AS5536-644G32Mn	AAP	Australia /New Zealand	LX.PAX0X.006	AS5536-644G32Mn VHP32ATAU1 MC UMACFbb 2*2G/320/BT/6L/5R/CB_bgn_FP_0.3D_EN12	AAQL64	NLED15.6 WXGAG	UMA	N	SO2GBII6	SO2GBII6	N320GB5.4KS	NSM8XS	3rd WiFi 1x2 BGN	3rd WiFi 1x2 BGN	BT 2.0	AES1610
AS5536-642G25Mn	AAP	Australia /New Zealand	LX.PAX0X.005	AS5536-642G25Mn VHP32ATAU1 MC UMACFbbM 1*2G/250/6L/5R/CB_bgn_FP_0.3D_EN12	AAQL64	NLED15.6 WXGAG	UMA	N	SO2GBII6	N	N250GB5.4KS	NSM8XS	3rd WiFi 1x2 BGN	3rd WiFi 1x2 BGN	N	AES1610
AS5536-721G32Mn	AAP	Philippines	LX.PAX0C.002	AS5536-721G32Mn LINPUSAPH1 UMACFbbM 1*1G/320/6L/5R/CB_bg_FP_0.3D_EN11	ATRM72	NLED15.6 WXGAG	UMA	N	SO1GBII6	N	N320GB5.4KS	NSM8XS	3rd WiFi 1x2 BGN	3rd WiFi 1x2 BGN	N	AES1610
AS5536-722G32Mn	AAP	Philippines	LX.PAX0C.001	AS5536-722G32Mn LINPUSAPH1 UMACFbbM 1*2G/320/6L/5R/CB_bg_FP_0.3D_EN11	ATRM72	NLED15.6 WXGAG	UMA	N	SO2GBII6	N	N320GB5.4KS	NSM8XS	3rd WiFi 1x2 BGN	3rd WiFi 1x2 BGN	N	AES1610
AS5536-642G25Mn	AAP	Australia /New Zealand	LX.PAX0X.002	AS5536-642G25Mn VHP32ATAU1 MC UMACFbbM 1*2G/250/BT/6L/5R/CB_bgn_FP_0.3D_EN12	AAQL64	NLED15.6 WXGAG	UMA	N	SO2GBII6	N	N250GB5.4KS	NSM8XS	3rd WiFi 1x2 BGN	3rd WiFi 1x2 BGN	BT 2.0	AES1610



Model	RO	Country	Acer Part No	Description	CPU	LCD	VGA Chip	VRAM 1	Memory 1	Memory 2	HDD 1(GB)	ODD	Wireless LAN	Wireless LAN1	Blue-tooth	Finger Print
AS5536-642G25Mn	AAP	Japan	LX.PAX0X.003	AS5536-642G25Mn VHP32APJP1 MC UMACFbbM 1*2G/250/BT/ 6L/5R/ CB_bgn_FP_0.3D_JA11_C F2F	AAQL64	NLED15.6 WXGAG	UMA	N	SO2GBII6	N	N250GB5.4KS	NSM8XS	3rd WiFi 1x2 BGN	3rd WiFi 1x2 BGN	BT 2.0	AES1610
AS5536-642G25Mn	AAP	Japan	LX.PAX0X.004	AS5536-642G25Mn VHP32APJP1 MC UMACFbbM 1*2G/250/BT/ 6L/5R/ CB_bgn_FP_0.3D_JA11AS 5536-CF2	AAQL64	NLED15.6 WXGAG	UMA	N	SO2GBII6	N	N250GB5.4KS	NSM8XS	3rd WiFi 1x2 BGN	3rd WiFi 1x2 BGN	BT 2.0	AES1610
AS5536-642G25Mn	AAP	Japan	LX.PAX0X.001	AS5536-642G25Mn VHP32APJP1 MC UMACFbbM 1*2G/250/BT/ 6L/5R/ CB_bgn_FP_0.3D_JA11	AAQL64	NLED15.6 WXGAG	UMA	N	SO2GBII6	N	N250GB5.4KS	NSM8XS	3rd WiFi 1x2 BGN	3rd WiFi 1x2 BGN	BT 2.0	AES1610
AS5536-723G50Mn	EMEA	UK	LX.PAW0X.07 5	AS5536-723G50Mn VHP32ATGB1 MC UMACbb 2G+1G/500_L/6L/5R/ CB_bgn_0.3D_EN14	ATRM72	NLED15.6 WXGAG	UMA	N	SO2GBII6	SO1GBII6	N500GB5.4KS	NSM8XS	3rd WiFi 1x2 BGN	3rd WiFi 1x2 BGN	N	N
AS5536-643G50Mn	EMEA	UK	LX.PAW0X.07 4	AS5536-643G50Mn VHP32ATGB1 MC UMACbb 2G+1G/500_L/6L/5R/ CB_bgn_0.3D_EN14	AAQL64	NLED15.6 WXGAG	UMA	N	SO2GBII6	SO1GBII6	N500GB5.4KS	NSM8XS	3rd WiFi 1x2 BGN	3rd WiFi 1x2 BGN	N	N
AS5536-643G32Mn	EMEA	Poland	LX.PAW0X.07 3	AS5536-643G32Mn VHP32ATPL1 MC UMACbb 2G+1G/320/6L/5R/ CB_bgn_0.3D_PL11	AAQL64	NLED15.6 WXGAG	UMA	N	SO2GBII6	SO1GBII6	N320GB5.4KS	NSM8XS	3rd WiFi 1x2 BGN	3rd WiFi 1x2 BGN	N	N
AS5536-643G16Mn	EMEA	Poland	LX.PAW0C.01 5	AS5536-643G16Mn LINPUSAPL1 UMACbb 2G+1G/160/6L/5R/ CB_bgn_0.3D_EN41	AAQL64	NLED15.6 WXGAG	UMA	N	SO2GBII6	SO1GBII6	N160GB5.4KS	NSM8XS	3rd WiFi 1x2 BGN	3rd WiFi 1x2 BGN	N	N
AS5536-642G25Mn	PA	USA	LX.PAW0C.01 3	AS5536-642G25Mn LINPUSAUS1 UMACbb 2*1G/250/6L/5R/ CB_bgn_0.3D_EN31	AAQL64	NLED15.6 WXGAG	UMA	N	SO1GBII6	SO1GBII6	N250GB5.4KS	NSM8XS	3rd WiFi 1x2 BGN	3rd WiFi 1x2 BGN	N	N
AS5536-642G25Mn	PA	ACL- Portugu ese	LX.PAW0C.01 2	AS5536-642G25Mn LINPUSAXC2 UMACbb 2*1G/250/6L/5R/ CB_bgn_0.3D_EN62	AAQL64	NLED15.6 WXGAG	UMA	N	SO1GBII6	SO1GBII6	N250GB5.4KS	NSM8XS	3rd WiFi 1x2 BGN	3rd WiFi 1x2 BGN	N	N
AS5536-643G32Mn	PA	USA	LX.PAW0C.01 0	AS5536-643G32Mn LINPUSAUS1 UMACbb 2G+1G/320/6L/5R/ CB_bgn_0.3D_EN31	AAQL64	NLED15.6 WXGAG	UMA	N	SO2GBII6	SO1GBII6	N320GB5.4KS	NSM8XS	3rd WiFi 1x2 BGN	3rd WiFi 1x2 BGN	N	N
AS5536-643G32Mn	PA	ACL- Portugu ese	LX.PAW0C.00 9	AS5536-643G32Mn LINPUSAXC2 UMACbb 2G+1G/320/6L/5R/ CB_bgn_0.3D_EN62	AAQL64	NLED15.6 WXGAG	UMA	N	SO2GBII6	SO1GBII6	N320GB5.4KS	NSM8XS	3rd WiFi 1x2 BGN	3rd WiFi 1x2 BGN	N	N
AS5536-643G25Mn	AAP	Australia /New Zealand	LX.PAW0X.07 2	AS5536-643G25Mn VHP32ATAU1 MC UMACbb 2G+1G/250/6L/5R/ CB_bgn_0.3D_EN12	AAQL64	NLED15.6 WXGAG	UMA	N	SO2GBII6	SO1GBII6	N250GB5.4KS	NSM8XS	3rd WiFi 1x2 BGN	3rd WiFi 1x2 BGN	N	N
AS5536-642G25Mn	PA	ACL- Spanish	LX.PAW0C.011	AS5536-642G25Mn LINPUSAEA3 UMACbb 2*1G/250/6L/5R/ CB_bgn_0.3D_EN61	AAQL64	NLED15.6 WXGAG	UMA	N	SO1GBII6	SO1GBII6	N250GB5.4KS	NSM8XS	3rd WiFi 1x2 BGN	3rd WiFi 1x2 BGN	N	N

Model	RO	Country	Acer Part No	Description	CPU	LCD	VGA Chip	VRAM 1	Memory 1	Memory 2	HDD 1(GB)	ODD	Wireless LAN	Wireless LAN1	Blue-tooth	Finger Print
AS5536-642G25Mn	PA	ACLA-Spanish	LX.PAW0C.014	AS5536-642G25Mn LNPUSAEA1 UMACbb 2*1G/250/6L/5R/ CB_bgn_0.3D_EN61	AAQL64	NLED15.6 WXGAG	UMA	N	SO1GBII6	SO1GBII6	N250GB5.4KS	NSM8XS	3rd WiFi 1x2 BGN	3rd WiFi 1x2 BGN	N	N
AS5536-643G32Mn	PA	ACLA-Spanish	LX.PAW0C.008	AS5536-643G32Mn LNPUSAEA1 UMACbb 2G+1G/320/6L/5R/ CB_bgn_0.3D_EN61	AAQL64	NLED15.6 WXGAG	UMA	N	SO2GBII6	SO1GBII6	N320GB5.4KS	NSM8XS	3rd WiFi 1x2 BGN	3rd WiFi 1x2 BGN	N	N
AS5536-643G32Mn	PA	ACLA-Spanish	LX.PAW0C.007	AS5536-643G32Mn LNPUSAEA3 UMACbb 2G+1G/320/6L/5R/ CB_bgn_0.3D_EN61	AAQL64	NLED15.6 WXGAG	UMA	N	SO2GBII6	SO1GBII6	N320GB5.4KS	NSM8XS	3rd WiFi 1x2 BGN	3rd WiFi 1x2 BGN	N	N
AS5536-644G32Mn	AAP	Australia /New Zealand	LX.PAW0X.071	AS5536-644G32Mn VHP32ATAU1 MC UMACbb 2*2G/320/6L/5R/ CB_bgn_0.3D_EN12	AAQL64	NLED15.6 WXGAG	UMA	N	SO2GBII6	SO2GBII6	N320GB5.4KS	NSM8XS	3rd WiFi 1x2 BGN	3rd WiFi 1x2 BGN	N	N
AS5536-724G50Mn	PA	ACLA-Spanish	LX.PAW0C.003	AS5536-724G50Mn LNPUSAEA3 UMACbb 2*2G/500_L/6L/5R/ CB_bgn_0.3D_EN61	ATRM72	NLED15.6 WXGAG	UMA	N	SO2GBII6	SO2GBII6	N500GB5.4KS	NSM8XS	3rd WiFi 1x2 BGN	3rd WiFi 1x2 BGN	N	N
AS5536-724G50Mn	PA	ACLA-Spanish	LX.PAW0C.004	AS5536-724G50Mn LNPUSAEA1 UMACbb 2*2G/500_L/6L/5R/ CB_bgn_0.3D_EN61	ATRM72	NLED15.6 WXGAG	UMA	N	SO2GBII6	SO2GBII6	N500GB5.4KS	NSM8XS	3rd WiFi 1x2 BGN	3rd WiFi 1x2 BGN	N	N
AS5536-724G50Mn	PA	ACLA-Portuguese	LX.PAW0C.006	AS5536-724G50Mn LNPUSAXC2 UMACbb 2*2G/500_L/6L/5R/ CB_bgn_0.3D_EN62	ATRM72	NLED15.6 WXGAG	UMA	N	SO2GBII6	SO2GBII6	N500GB5.4KS	NSM8XS	3rd WiFi 1x2 BGN	3rd WiFi 1x2 BGN	N	N
AS5536-724G50Mn	PA	USA	LX.PAW0C.005	AS5536-724G50Mn LNPUSASU1 UMACbb 2*2G/500_L/6L/5R/ CB_bgn_0.3D_EN31	ATRM72	NLED15.6 WXGAG	UMA	N	SO2GBII6	SO2GBII6	N500GB5.4KS	NSM8XS	3rd WiFi 1x2 BGN	3rd WiFi 1x2 BGN	N	N
AS5536-644G25Mn	EMEA	France	LX.PAW0Y.001	AS5536-644G25Mn VHB32ATFR1 MC UMACbb 2*2G/250/6L/5R/ CB_bgn_0.3D_FR23	AAQL64	NLED15.6 WXGAG	UMA	N	SO2GBII6	SO2GBII6	N250GB5.4KS	NSM8XS	3rd WiFi 1x2 BGN	3rd WiFi 1x2 BGN	N	N
AS5536-642G25Mn	EMEA	Poland	LX.PAW0C.001	AS5536-642G25Mn LNPUSAPL1 UMACbb 1*2G/250/6L/5R/ CB_bgn_0.3D_EN41	AAQL64	NLED15.6 WXGAG	UMA	N	SO2GBII6	N	N250GB5.4KS	NSM8XS	3rd WiFi 1x2 BGN	3rd WiFi 1x2 BGN	N	N
AS5536-643G32Mn	EMEA	Poland	LX.PAW0X.069	AS5536-643G32Mn VHP32ATPL1 MC UMACbb 1G+2G/320/6L/5R/ CB_bgn_0.3D_PL11	AAQL64	NLED15.6 WXGAG	UMA	N	SO1GBII6	SO2GBII6	N320GB5.4KS	NSM8XS	3rd WiFi 1x2 BGN	3rd WiFi 1x2 BGN	N	N
AS5536-643G32Mn	EMEA	Poland	LX.PAW0C.002	AS5536-643G32Mn LNPUSAPL1 UMACbb 1G+2G/320/6L/5R/ CB_bgn_0.3D_EN41	AAQL64	NLED15.6 WXGAG	UMA	N	SO1GBII6	SO2GBII6	N320GB5.4KS	NSM8XS	3rd WiFi 1x2 BGN	3rd WiFi 1x2 BGN	N	N
AS5536-642G32Mn	EMEA	Poland	LX.PAW0X.070	AS5536-642G32Mn VHP32ATPL1 MC UMACbb 1*2G/320/6L/5R/ CB_bgn_0.3D_PL11	AAQL64	NLED15.6 WXGAG	UMA	N	SO2GBII6	N	N320GB5.4KS	NSM8XS	3rd WiFi 1x2 BGN	3rd WiFi 1x2 BGN	N	N
AS5536-643G32Mn	PA	USA	LX.PAW0X.068	AS5536-643G32Mn VHP32ATUS1 MC UMACbb 2G+1G/320/6L/5R/ CB_bgn_0.3D_EN32	AAQL64	NLED15.6 WXGAG	UMA	N	SO2GBII6	SO1GBII6	N320GB5.4KS	NSM8XS	3rd WiFi 1x2 BGN	3rd WiFi 1x2 BGN	N	N

Model	RO	Country	Acer Part No	Description	CPU	LCD	VGA Chip	VRAM 1	Memory 1	Memory 2	HDD 1(GB)	ODD	Wireless LAN	Wireless LAN1	Blue-tooth	Finger Print
AS5536-724G25Mn	EMEA	UK	LX.PAW0X.067	AS5536-724G25Mn VHP32ATGB1 MC UMACbb 2*2G/250/6L/5R/ CB_bgn_0.3D_EN14	ATRM72	NLED15.6 WXGAG	UMA	N	SO2GBII6	SO2GBII6	N250GB5.4KS	NSM8XS	3rd WiFi 1x2 BGN	3rd WiFi 1x2 BGN	N	N
AS5536-724G32Mn	EMEA	UK	LX.PAW0X.066	AS5536-724G32Mn VHP32ATGB1 MC UMACbb 2*2G/320/6L/5R/ CB_bgn_0.3D_EN14	ATRM72	NLED15.6 WXGAG	UMA	N	SO2GBII6	SO2GBII6	N320GB5.4KS	NSM8XS	3rd WiFi 1x2 BGN	3rd WiFi 1x2 BGN	N	N
AS5536-642G25Mn	PA	ACLA-Portuguese	LX.PAW0X.065	AS5536-642G25Mn EM VHP32ATXC2 MC UMACbb 2*1G/250/6L/5R/ CB_bgn_0.3D_XC21	AAQL64	NLED15.6 WXGAG	UMA	N	SO1GBII6	SO1GBII6	N250GB5.4KS	NSM8XS	3rd WiFi 1x2 BGN	3rd WiFi 1x2 BGN	N	N
AS5536-642G25Mn	PA	ACLA-Spanish	LX.PAW0X.064	AS5536-642G25Mn EM VHP32ATEA3 MC UMACbb 2*1G/250/6L/5R/ CB_bgn_0.3D_ES22	AAQL64	NLED15.6 WXGAG	UMA	N	SO1GBII6	SO1GBII6	N250GB5.4KS	NSM8XS	3rd WiFi 1x2 BGN	3rd WiFi 1x2 BGN	N	N
AS5536-723G32Mn	PA	ACLA-Spanish	LX.PAW0X.067	AS5536-723G32Mn EM VHP32ATEA1 MC UMACbb 2G+1G/320/6L/5R/ CB_bgn_0.3D_ES22	ATRM72	NLED15.6 WXGAG	UMA	N	SO2GBII6	SO1GBII6	N320GB5.4KS	NSM8XS	3rd WiFi 1x2 BGN	3rd WiFi 1x2 BGN	N	N
AS5536-723G32Mn	PA	ACLA-Spanish	LX.PAW0X.068	AS5536-723G32Mn EM VHP32ATEA3 MC UMACbb 2G+1G/320/6L/5R/ CB_bgn_0.3D_ES22	ATRM72	NLED15.6 WXGAG	UMA	N	SO2GBII6	SO1GBII6	N320GB5.4KS	NSM8XS	3rd WiFi 1x2 BGN	3rd WiFi 1x2 BGN	N	N
AS5536-643G25Mn	PA	ACLA-Portuguese	LX.PAW0X.061	AS5536-643G25Mn EM VHP32ATXC2 MC UMACbb 2G+1G/250/6L/5R/ CB_bgn_0.3D_XC21	AAQL64	NLED15.6 WXGAG	UMA	N	SO2GBII6	SO1GBII6	N250GB5.4KS	NSM8XS	3rd WiFi 1x2 BGN	3rd WiFi 1x2 BGN	N	N
AS5536-643G25Mn	PA	ACLA-Spanish	LX.PAW0X.062	AS5536-643G25Mn EM VHP32ATEA3 MC UMACbb 2G+1G/250/6L/5R/ CB_bgn_0.3D_ES22	AAQL64	NLED15.6 WXGAG	UMA	N	SO2GBII6	SO1GBII6	N250GB5.4KS	NSM8XS	3rd WiFi 1x2 BGN	3rd WiFi 1x2 BGN	N	N
AS5536-723G32Mn	PA	ACLA-Portuguese	LX.PAW0X.069	AS5536-723G32Mn EM VHP32ATXC2 MC UMACbb 2G+1G/320/6L/5R/ CB_bgn_0.3D_XC21	ATRM72	NLED15.6 WXGAG	UMA	N	SO2GBII6	SO1GBII6	N320GB5.4KS	NSM8XS	3rd WiFi 1x2 BGN	3rd WiFi 1x2 BGN	N	N
AS5536-643G25Mn	PA	ACLA-Spanish	LX.PAW0X.060	AS5536-643G25Mn EM VHP32ATEA1 MC UMACbb 2G+1G/250/6L/5R/ CB_bgn_0.3D_ES22	AAQL64	NLED15.6 WXGAG	UMA	N	SO2GBII6	SO1GBII6	N250GB5.4KS	NSM8XS	3rd WiFi 1x2 BGN	3rd WiFi 1x2 BGN	N	N
AS5536-642G25Mn	PA	ACLA-Spanish	LX.PAW0X.063	AS5536-642G25Mn EM VHP32ATEA1 MC UMACbb 2*1G/250/6L/5R/ CB_bgn_0.3D_ES22	AAQL64	NLED15.6 WXGAG	UMA	N	SO1GBII6	SO1GBII6	N250GB5.4KS	NSM8XS	3rd WiFi 1x2 BGN	3rd WiFi 1x2 BGN	N	N
AS5536-643G32M	PA	USA	LX.PAW0X.066	AS5536-643G32MVHP32ATUS1 MC UMACbbM 2G+1G/320/6L/5R/CB_0.3D_EN32	AAQL64	NLED15.6 WXGAG	UMA	N	SO2GBII6	SO1GBII6	N320GB5.4KS	NSM8XS	N	N	N	N
AS5536-642G25Mn	AAP	Australia/Zealand	LX.PAW0X.065	AS5536-642G25Mn VHP32ATAU1 MC UMACbbM 1*2G/250/6L/5R/ CB_bgn_0.3D_EN12	AAQL64	NLED15.6 WXGAG	UMA	N	SO2GBII6	N	N250GB5.4KS	NSM8XS	3rd WiFi 1x2 BGN	3rd WiFi 1x2 BGN	N	N
AS5536-642G25Mn	AAP	Japan	LX.PAW0X.064	AS5536-642G25Mn VHP32APJP1 MC UMACbbM 1*2G/250/6L/5R/ CB_bgn_0.3D_JA11	AAQL64	NLED15.6 WXGAG	UMA	N	SO2GBII6	N	N250GB5.4KS	NSM8XS	3rd WiFi 1x2 BGN	3rd WiFi 1x2 BGN	N	N

Model	RO	Country	Acer Part No	Description	CPU	LCD	VGA Chip	VRAM 1	Memory 1	Memory 2	HDD 1(GB)	ODD	Wireless LAN	Wireless LAN1	Blue-tooth	Finger Print
AS5536-642G25Mn	AAP	Japan	LX.PAW0X.053	AS5536-642G25Mn VHP32AJP1 MC UMACbbm 1*2G/250/BT/6L/5R/ CB_bgn_0.3D_JA11_C2	AAQL64	NLED15.6 WXGAG	UMA	N	SO2GBII6	N	N250GB5.4KS	NSM8XS	3rd WiFi 1x2 BGN	3rd WiFi 1x2 BGN	BT 2.0	N
AS5536-642G25Mn	AAP	Japan	LX.PAW0X.052	AS5536-642G25Mn VHP32APJP1 MC UMACbbm 1*2G/250/BT/6L/5R/ CB_bgn_0.3D_JA11_C2F	AAQL64	NLED15.6 WXGAG	UMA	N	SO2GBII6	N	N250GB5.4KS	NSM8XS	3rd WiFi 1x2 BGN	3rd WiFi 1x2 BGN	BT 2.0	N
AS5536-642G16Mn	AAP	Japan	LX.PAW0X.051	AS5536-642G16Mn VHP32AJP1 MC UMACbbm 1*2G/160/BT/6L/5R/ CB_bgn_0.3D_JA11_C1	AAQL64	NLED15.6 WXGAG	UMA	N	SO2GBII6	N	N160GB5.4KS	NSM8XS	3rd WiFi 1x2 BGN	3rd WiFi 1x2 BGN	BT 2.0	N
AS5536-642G16Mn	AAP	Japan	LX.PAW0X.050	AS5536-642G16Mn VHP32APJP1 MC UMACbbm 1*2G/160/BT/6L/5R/ CB_bgn_0.3D_JA11_C1F	AAQL64	NLED15.6 WXGAG	UMA	N	SO2GBII6	N	N160GB5.4KS	NSM8XS	3rd WiFi 1x2 BGN	3rd WiFi 1x2 BGN	BT 2.0	N
AS5536-642G25Mn	AAP	Japan	LX.PAW0X.048	AS5536-642G25Mn VHP32APJP1 MC UMACbbm 1*2G/250/6L/5R/ CB_bgn_0.3D_JA11_C3F	AAQL64	NLED15.6 WXGAG	UMA	N	SO2GBII6	N	N250GB5.4KS	NSM8XS	3rd WiFi 1x2 BGN	3rd WiFi 1x2 BGN	N	N
AS5536-642G25Mn	AAP	Japan	LX.PAW0X.049	AS5536-642G25Mn VHP32AJP1 MC UMACbbm 1*2G/250/6L/5R/ CB_bgn_0.3D_JA11_C3	AAQL64	NLED15.6 WXGAG	UMA	N	SO2GBII6	N	N250GB5.4KS	NSM8XS	3rd WiFi 1x2 BGN	3rd WiFi 1x2 BGN	N	N
AS5536-723G25Mn	EMEA	UK	LX.PAW0X.047	AS5536-723G25Mn VHP32ATGB1 MC UMACbbm 2G+1G/250/6L/5R/ CB_bgn_0.3D_EN14	ATRM72	NLED15.6 WXGAG	UMA	N	SO2GBII6	SO1GBII6	N250GB5.4KS	NSM8XS	3rd WiFi 1x2 BGN	3rd WiFi 1x2 BGN	N	N
AS5536-743G32Mn	EMEA	UK	LX.PAW0X.046	AS5536-743G32Mn VHP32ATGB1 MC UMACbbm 2G+1G/320/6L/5R/ CB_bgn_0.3D_EN14	ATRM74	NLED15.6 WXGAG	UMA	N	SO2GBII6	SO1GBII6	N320GB5.4KS	NSM8XS	3rd WiFi 1x2 BGN	3rd WiFi 1x2 BGN	N	N
AS5536-744G25Mn	EMEA	UK	LX.PAW0X.045	AS5536-744G25Mn VHP32ATGB1 MC UMACbbm 2*2G/250/6L/5R/ CB_bgn_0.3D_EN14	ATRM74	NLED15.6 WXGAG	UMA	N	SO2GBII6	SO2GBII6	N250GB5.4KS	NSM8XS	3rd WiFi 1x2 BGN	3rd WiFi 1x2 BGN	N	N
AS5536-644G25Mn	EMEA	Middle East	LX.PAW0X.005	AS5536-644G25Mn EM VHP32ATME4 MC UMACbbm 2*2G/250/6L/ CB_bgn_0.3D_EN11	AAQL64	NLED15.6 WXGAG	UMA	N	SO2GBII6	SO2GBII6	N250GB5.4KS	NSM8XS	3rd WiFi 1x2 BGN	3rd WiFi 1x2 BGN	N	N
AS5536-644G25Mn	EMEA	Sweden	LX.PAW0X.031	AS5536-644G25Mn VHP32ATSE1 MC UMACbbm 2*2G/250/6L/ CB_bgn_0.3D_FH13	AAQL64	NLED15.6 WXGAG	UMA	N	SO2GBII6	SO2GBII6	N250GB5.4KS	NSM8XS	3rd WiFi 1x2 BGN	3rd WiFi 1x2 BGN	N	N
AS5536-644G25Mn	EMEA	Czech	LX.PAW0X.030	AS5536-644G25Mn VHP32ATC22 MC UMACbbm 2*2G/250/6L/ CB_bgn_0.3D_SK12	AAQL64	NLED15.6 WXGAG	UMA	N	SO2GBII6	SO2GBII6	N250GB5.4KS	NSM8XS	3rd WiFi 1x2 BGN	3rd WiFi 1x2 BGN	N	N
AS5536-644G25Mn	EMEA	Eastern Europe	LX.PAW0X.020	AS5536-644G25Mn VHP32ATEU5 MC UMACbbm 2*2G/250/6L/ CB_bgn_0.3D_RO12	AAQL64	NLED15.6 WXGAG	UMA	N	SO2GBII6	SO2GBII6	N250GB5.4KS	NSM8XS	3rd WiFi 1x2 BGN	3rd WiFi 1x2 BGN	N	N
AS5536-644G25Mn	EMEA	Eastern Europe	LX.PAW0X.017	AS5536-644G25Mn VHP32ATEU3 MC UMACbbm 2*2G/250/6L/ CB_bgn_0.3D_RU23	AAQL64	NLED15.6 WXGAG	UMA	N	SO2GBII6	SO2GBII6	N250GB5.4KS	NSM8XS	3rd WiFi 1x2 BGN	3rd WiFi 1x2 BGN	N	N

Model	RO	Country	Acer Part No	Description	CPU	LCD	VGA Chip	VRAM 1	Memory 1	Memory 2	HDD 1(GB)	ODD	Wireless LAN	Wireless LAN1	Blue-tooth	Finger Print
AS5536-644G25Mn	EMEA	Eastern Europe	LX.PAW0X.018	AS5536-644G25Mn VHP32ATEU5 MC UMACbbM 2*2G/250/6L/ CB_bgn_0.3D_PL13	AAQL64	NLED15.6 WXGAG	UMA	N	SO2GBII6	SO2GBII6	N250GB5.4KS	NSM8XS	3rd WiFi 1x2 BGN	3rd WiFi 1x2 BGN	N	N
AS5536-644G25Mn	EMEA	Eastern Europe	LX.PAW0X.019	AS5536-644G25Mn VHP32ATEU7 MC UMACbbM 2*2G/250/6L/ CB_bgn_0.3D_ENR2	AAQL64	NLED15.6 WXGAG	UMA	N	SO2GBII6	SO2GBII6	N250GB5.4KS	NSM8XS	3rd WiFi 1x2 BGN	3rd WiFi 1x2 BGN	N	N
AS5536-644G25Mn	EMEA	Eastern Europe	LX.PAW0X.021	AS5536-644G25Mn VHP32ATEU7 MC UMACbbM 2*2G/250/6L/ CB_bgn_0.3D_SL11	AAQL64	NLED15.6 WXGAG	UMA	N	SO2GBII6	SO2GBII6	N250GB5.4KS	NSM8XS	3rd WiFi 1x2 BGN	3rd WiFi 1x2 BGN	N	N
AS5536-644G25Mn	EMEA	Eastern Europe	LX.PAW0X.016	AS5536-644G25Mn VHP32ATEU4 MC UMACbbM 2*2G/250/6L/ CB_bgn_0.3D_SV22	AAQL64	NLED15.6 WXGAG	UMA	N	SO2GBII6	SO2GBII6	N250GB5.4KS	NSM8XS	3rd WiFi 1x2 BGN	3rd WiFi 1x2 BGN	N	N
AS5536-644G25Mn	EMEA	Middle East	LX.PAW0X.006	AS5536-644G25Mn EM VHP32ATME2 MC UMACbbM 2*2G/250/6L/ CB_bgn_0.3D_EN15	AAQL64	NLED15.6 WXGAG	UMA	N	SO2GBII6	SO2GBII6	N250GB5.4KS	NSM8XS	3rd WiFi 1x2 BGN	3rd WiFi 1x2 BGN	N	N
AS5536-644G25Mn	EMEA	Middle East	LX.PAW0X.007	AS5536-644G25Mn EM VHP32ATME6 MC UMACbbM 2*2G/250/6L/ CB_bgn_0.3D_EN15	AAQL64	NLED15.6 WXGAG	UMA	N	SO2GBII6	SO2GBII6	N250GB5.4KS	NSM8XS	3rd WiFi 1x2 BGN	3rd WiFi 1x2 BGN	N	N
AS5536-644G25Mn	EMEA	Middle East	LX.PAW0X.008	AS5536-644G25Mn EM VHP32ATME9 MC UMACbbM 2*2G/250/6L/ CB_bgn_0.3D_FR22	AAQL64	NLED15.6 WXGAG	UMA	N	SO2GBII6	SO2GBII6	N250GB5.4KS	NSM8XS	3rd WiFi 1x2 BGN	3rd WiFi 1x2 BGN	N	N
AS5536-644G25Mn	EMEA	Italy	LX.PAW0X.009	AS5536-644G25Mn VHP32ATIT1 MC UMACbbM 2*2G/250/6L/ CB_bgn_0.3D_IT12	AAQL64	NLED15.6 WXGAG	UMA	N	SO2GBII6	SO2GBII6	N250GB5.4KS	NSM8XS	3rd WiFi 1x2 BGN	3rd WiFi 1x2 BGN	N	N
AS5536-644G25Mn	EMEA	Israel	LX.PAW0X.010	AS5536-644G25Mn VHP32ATIL1 MC UMACbbM 2*2G/250/6L/ CB_bgn_0.3D_HE12	AAQL64	NLED15.6 WXGAG	UMA	N	SO2GBII6	SO2GBII6	N250GB5.4KS	NSM8XS	3rd WiFi 1x2 BGN	3rd WiFi 1x2 BGN	N	N
AS5536-644G25Mn	EMEA	Greece	LX.PAW0X.011	AS5536-644G25Mn VHP32ATGR1 MC UMACbbM 2*2G/250/6L/ CB_bgn_0.3D_EL32	AAQL64	NLED15.6 WXGAG	UMA	N	SO2GBII6	SO2GBII6	N250GB5.4KS	NSM8XS	3rd WiFi 1x2 BGN	3rd WiFi 1x2 BGN	N	N
AS5536-644G25Mn	EMEA	Spain	LX.PAW0X.012	AS5536-644G25Mn VHP32ATES1 MC UMACbbM 2*2G/250/6L/ CB_bgn_0.3D_ES22	AAQL64	NLED15.6 WXGAG	UMA	N	SO2GBII6	SO2GBII6	N250GB5.4KS	NSM8XS	3rd WiFi 1x2 BGN	3rd WiFi 1x2 BGN	N	N
AS5536-644G25Mn	EMEA	Portugal	LX.PAW0X.013	AS5536-644G25Mn VHP32ATPT1 MC UMACbbM 2*2G/250/6L/ CB_bgn_0.3D_PT12	AAQL64	NLED15.6 WXGAG	UMA	N	SO2GBII6	SO2GBII6	N250GB5.4KS	NSM8XS	3rd WiFi 1x2 BGN	3rd WiFi 1x2 BGN	N	N
AS5536-644G25Mn	EMEA	Hungary	LX.PAW0X.014	AS5536-644G25Mn VHP32ATHU1 MC UMACbbM 2*2G/250/6L/ CB_bgn_0.3D_HU13	AAQL64	NLED15.6 WXGAG	UMA	N	SO2GBII6	SO2GBII6	N250GB5.4KS	NSM8XS	3rd WiFi 1x2 BGN	3rd WiFi 1x2 BGN	N	N
AS5536-644G25Mn	EMEA	Finland	LX.PAW0X.015	AS5536-644G25Mn VHP32ATF12 MC UMACbbM 2*2G/250/6L/ CB_bgn_0.3D_F111	AAQL64	NLED15.6 WXGAG	UMA	N	SO2GBII6	SO2GBII6	N250GB5.4KS	NSM8XS	3rd WiFi 1x2 BGN	3rd WiFi 1x2 BGN	N	N

Model	RO	Country	Acer Part No	Description	CPU	LCD	VGA Chip	VRAM 1	Memory 1	Memory 2	HDD 1(GB)	ODD	Wireless LAN	Wireless LAN1	Blue-tooth	Finger Print
AS5536-644G25Mn	EMEA	Turkey	LX.PAW0X.025	AS5536-644G25Mn EM VHP32ATR1 MC UMACbbM 2*2G/250/6L/CB_bgn_0.3D_TR33	AAQL64	NLED15.6 WXGAG	UMA	N	SO2GBII6	SO2GBII6	N250GB5.4KS	NSM8XS	3rd WiFi 1x2 BGN	3rd WiFi 1x2 BGN	N	N
AS5536-644G25Mn	EMEA	Poland	LX.PAW0X.026	AS5536-644G25Mn VHP32ATPL1 MC UMACbbM 2*2G/250/6L/CB_bgn_0.3D_PL11	AAQL64	NLED15.6 WXGAG	UMA	N	SO2GBII6	SO2GBII6	N250GB5.4KS	NSM8XS	3rd WiFi 1x2 BGN	3rd WiFi 1x2 BGN	N	N
AS5536-644G25Mn	EMEA	Switzerland	LX.PAW0X.027	AS5536-644G25Mn VHP32ATCH1 MC UMACbbM 2*2G/250/6L/CB_bgn_0.3D_IT42	AAQL64	NLED15.6 WXGAG	UMA	N	SO2GBII6	SO2GBII6	N250GB5.4KS	NSM8XS	3rd WiFi 1x2 BGN	3rd WiFi 1x2 BGN	N	N
AS5536-644G25Mn	EMEA	South Africa	LX.PAW0X.043	AS5536-644G25Mn EM VHP32ATZA1 MC UMACbbM 2*2G/250/6L/CB_bgn_0.3D_FR23	AAQL64	NLED15.6 WXGAG	UMA	N	SO2GBII6	SO2GBII6	N250GB5.4KS	NSM8XS	3rd WiFi 1x2 BGN	3rd WiFi 1x2 BGN	N	N
AS5536-644G25Mn	EMEA	Denmark	LX.PAW0X.041	AS5536-644G25Mn VHP32ATDK2 MC UMACbbM 2*2G/250/6L/CB_bgn_0.3D_ENS3	AAQL64	NLED15.6 WXGAG	UMA	N	SO2GBII6	SO2GBII6	N250GB5.4KS	NSM8XS	3rd WiFi 1x2 BGN	3rd WiFi 1x2 BGN	N	N
AS5536-644G25Mn	EMEA	Germany	LX.PAW0X.039	AS5536-644G25Mn VHP32ATDE1 MC UMACbbM 2*2G/250/6L/CB_bgn_0.3D_DE13	AAQL64	NLED15.6 WXGAG	UMA	N	SO2GBII6	SO2GBII6	N250GB5.4KS	NSM8XS	3rd WiFi 1x2 BGN	3rd WiFi 1x2 BGN	N	N
AS5536-644G25Mn	EMEA	Holland	LX.PAW0X.037	AS5536-644G25Mn VHP32ATNL1 MC UMACbbM 2*2G/250/6L/CB_bgn_0.3D_NL12	AAQL64	NLED15.6 WXGAG	UMA	N	SO2GBII6	SO2GBII6	N250GB5.4KS	NSM8XS	3rd WiFi 1x2 BGN	3rd WiFi 1x2 BGN	N	N
AS5536-644G25Mn	EMEA	Norway	LX.PAW0X.035	AS5536-644G25Mn VHP32ATNO1 MC UMACbbM 2*2G/250/6L/CB_bgn_0.3D_NO12	AAQL64	NLED15.6 WXGAG	UMA	N	SO2GBII6	SO2GBII6	N250GB5.4KS	NSM8XS	3rd WiFi 1x2 BGN	3rd WiFi 1x2 BGN	N	N
AS5536-644G25Mn	EMEA	Austria	LX.PAW0X.032	AS5536-644G25Mn VHP32ATAT1 MC UMACbbM 2*2G/250/6L/CB_bgn_0.3D_DE11	AAQL64	NLED15.6 WXGAG	UMA	N	SO2GBII6	SO2GBII6	N250GB5.4KS	NSM8XS	3rd WiFi 1x2 BGN	3rd WiFi 1x2 BGN	N	N
AS5536-644G25Mi	EMEA	Russia	LX.PAW0X.033	AS5536-644G25Mi VHP32ATRU1 MC UMACbbM 2*2G/250/6L/CB_bgn_0.3D_RU11	AAQL64	NLED15.6 WXGAG	UMA	N	SO2GBII6	SO2GBII6	N250GB5.4KS	NSM8XS	3rd WiFi 1x2 BGN	3rd WiFi BG	N	N
AS5536-644G25Mn	EMEA	Norway	LX.PAW0X.034	AS5536-644G25Mn VHP32ATNO3 MC UMACbbM 2*2G/250/6L/CB_bgn_0.3D_ENS3	AAQL64	NLED15.6 WXGAG	UMA	N	SO2GBII6	SO2GBII6	N250GB5.4KS	NSM8XS	3rd WiFi 1x2 BGN	3rd WiFi 1x2 BGN	N	N
AS5536-644G25Mn	EMEA	Luxembourg	LX.PAW0X.036	AS5536-644G25Mn VHP32ATLU3 MC UMACbbM 2*2G/250/6L/CB_bgn_0.3D_IT41	AAQL64	NLED15.6 WXGAG	UMA	N	SO2GBII6	SO2GBII6	N250GB5.4KS	NSM8XS	3rd WiFi 1x2 BGN	3rd WiFi 1x2 BGN	N	N
AS5536-644G25Mn	EMEA	Belgium	LX.PAW0X.038	AS5536-644G25Mn VHP32ATBE1 MC UMACbbM 2*2G/250/6L/CB_bgn_0.3D_NL13	AAQL64	NLED15.6 WXGAG	UMA	N	SO2GBII6	SO2GBII6	N250GB5.4KS	NSM8XS	3rd WiFi 1x2 BGN	3rd WiFi 1x2 BGN	N	N
AS5536-644G25Mn	EMEA	France	LX.PAW0X.040	AS5536-644G25Mn VHP32ATFR1 MC UMACbbM 2*2G/250/6L/CB_bgn_0.3D_FR23	AAQL64	NLED15.6 WXGAG	UMA	N	SO2GBII6	SO2GBII6	N250GB5.4KS	NSM8XS	3rd WiFi 1x2 BGN	3rd WiFi 1x2 BGN	N	N

Model	RO	Country	Acer Part No	Description	CPU	LCD	VGA Chip	VRAM 1	Memory 1	Memory 2	HDD 1(GB)	ODD	Wireless LAN	Wireless LAN1	Blue-tooth	Finger Print
AS5536-644G25Mn	EMEA	Denmark	LX.PAW0X.042	AS5536-644G25Mn VHP32ATDK1 MC UMACbbM 2*2G/250/6L/ CB_bgn_0.3D_NO13	AAQL64	NLED15.6 WXGAG	UMA	N	SO2GBII6	SO2GBII6	N250GB5.4KS	NSM8XS	3rd WiFi 1x2 BGN	3rd WiFi 1x2 BGN	N	N
AS5536-644G25Mn	EMEA	South Africa	LX.PAW0X.044	AS5536-644G25Mn EM VHP32ATAZ2 MC UMACbbM 2*2G/250/6L/ CB_bgn_0.3D_EN16	AAQL64	NLED15.6 WXGAG	UMA	N	SO2GBII6	SO2GBII6	N250GB5.4KS	NSM8XS	3rd WiFi 1x2 BGN	3rd WiFi 1x2 BGN	N	N
AS5536-644G25Mn	EMEA	UK	LX.PAW0X.029	AS5536-644G25Mn VHP32ATGB1 MC UMACbbM 2*2G/250/6L/ CB_bgn_0.3D_EN14	AAQL64	NLED15.6 WXGAG	UMA	N	SO2GBII6	SO2GBII6	N250GB5.4KS	NSM8XS	3rd WiFi 1x2 BGN	3rd WiFi 1x2 BGN	N	N
AS5536-644G25Mi	EMEA	Ukraine	LX.PAW0X.028	AS5536-644G25Mi VHP32ATUK1 MC UMACbbM 2*2G/250/6L/ CB_bg_0.3D_RU11	AAQL64	NLED15.6 WXGAG	UMA	N	SO2GBII6	SO2GBII6	N250GB5.4KS	NSM8XS	3rd WiFi 1x2 BGN	3rd WiFi BG	N	N
AS5536-642G32M	PA	USA	LX.PAW0X.004	AS5536-642G32MVHP32ATUS1 MC UMACbbM 2*1G/320/6L/ CB_0.3D_EN33	AAQL64	NLED15.6 WXGAG	UMA	N	SO1GBII6	SO1GBII6	N320GB5.4KS	NSM8XS	N	N	N	N
AS5536-642G32M	PA	ACLA-Portuguese	LX.PAW0X.002	AS5536-642G32MEM VHP32ATXC1 MC UMACbbM 2*1G/320/6L/ CB_0.3D_XC22	AAQL64	NLED15.6 WXGAG	UMA	N	SO1GBII6	SO1GBII6	N320GB5.4KS	NSM8XS	N	N	N	N
AS5536-642G32M	PA	ACLA-Portuguese	LX.PAW0X.001	AS5536-642G32MVHP32ATXC1 MC UMACbbM 2*1G/320/6L/ CB_0.3D_XC21	AAQL64	NLED15.6 WXGAG	UMA	N	SO1GBII6	SO1GBII6	N320GB5.4KS	NSM8XS	N	N	N	N
AS5536-644G25Mn	EMEA	Middle East	LX.PAW0X.023	AS5536-644G25Mn EM VHP32ATME3 MC UMACbbM 2*2G/250/6L/ CB_bgn_0.3D_FR23	AAQL64	NLED15.6 WXGAG	UMA	N	SO2GBII6	SO2GBII6	N250GB5.4KS	NSM8XS	3rd WiFi 1x2 BGN	3rd WiFi 1x2 BGN	N	N
AS5536-644G25Mn	EMEA	Middle East	LX.PAW0X.024	AS5536-644G25Mn EM VHP32ATME2 MC UMACbbM 2*2G/250/6L/ CB_bgn_0.3D_AR23	AAQL64	NLED15.6 WXGAG	UMA	N	SO2GBII6	SO2GBII6	N250GB5.4KS	NSM8XS	3rd WiFi 1x2 BGN	3rd WiFi 1x2 BGN	N	N
AS5536-644G25Mn	EMEA	Middle East	LX.PAW0X.022	AS5536-644G25Mn EM VHP32ATME2 MC UMACbbM 2*2G/250/6L/ CB_bgn_0.3D_AR13	AAQL64	NLED15.6 WXGAG	UMA	N	SO2GBII6	SO2GBII6	N250GB5.4KS	NSM8XS	3rd WiFi 1x2 BGN	3rd WiFi 1x2 BGN	N	N
AS5536-642G32M	PA	USA	LX.PAW0X.003	AS5536-642G32MVHP32ATUS1 MC UMACbbM 2*1G/320/6L/ CB_0.3D_EN32	AAQL64	NLED15.6 WXGAG	UMA	N	SO1GBII6	SO1GBII6	N320GB5.4KS	NSM8XS	N	N	N	N
AS5536-644G16Mn	EMEA	UK	LX.PAV0Y.007	AS5536-644G16Mn VHB32ATGB1 MC UMAbb 2*2G/160/6L/5R/ CB_bgn_EN14	AAQL64	NLED15.6 WXGAG	UMA	N	SO2GBII6	SO2GBII6	N160GB5.4KS	NSM8XS	3rd WiFi 1x2 BGN	3rd WiFi 1x2 BGN	N	N
AS5536-643G25Mn	EMEA	UK	LX.PAV0Y.006	AS5536-643G25Mn VHB32ATGB1 MC UMAbb 2G+1G/250/6L/5R/ CB_bgn_EN14	AAQL64	NLED15.6 WXGAG	UMA	N	SO2GBII6	SO1GBII6	N250GB5.4KS	NSM8XS	3rd WiFi 1x2 BGN	3rd WiFi 1x2 BGN	N	N
AS5536-644G25Mn	EMEA	UK	LX.PAV0X.002	AS5536-644G25Mn VHP32ATGB1 MC UMAbb 2*2G/250/6L/5R/ CB_bgn_EN14	AAQL64	NLED15.6 WXGAG	UMA	N	SO2GBII6	SO2GBII6	N250GB5.4KS	NSM8XS	3rd WiFi 1x2 BGN	3rd WiFi 1x2 BGN	N	N

Model	RO	Country	Acer Part No	Description	CPU	LCD	VGA Chip	VRAM 1	Memory 1	Memory 2	HDD 1(GB)	ODD	Wireless LAN	Wireless LAN1	Blue-tooth	Finger Print
AS5536-721G32Mn	AAP	Philippines	LX.PAV0Y.005	AS5536-721G32Mn EM VHB32ATPH1 MC UMAbbm 1*1G/320/BT/6L/5R/ CB_bg_EN14	ATRM72	NLED15.6 WXGAG	UMA	N	SO1GBII6	N	N320GB5.4KS	NSM8XS	3rd WiFi 1x2 BGN	3rd WiFi 1x2 BGN	BT 2.0	N
AS5536-722G32Mn	AAP	Philippines	LX.PAV0X.001	AS5536-722G32Mn EM VHP32ATPH1 MC UMAbbm 1*2G/320/BT/6L/5R/ CB_bg_EN14	ATRM72	NLED15.6 WXGAG	UMA	N	SO2GBII6	N	N320GB5.4KS	NSM8XS	3rd WiFi 1x2 BGN	3rd WiFi 1x2 BGN	BT 2.0	N
AS5536-642G25Mn	PA	Canada	LX.PAV0Y.004	AS5536-642G25Mn VHB32ATCA2 MC UMAbbm 2*1G/250/6L/CB_bgn_FR31	AAQL64	NLED15.6 WXGAG	UMA	N	SO1GBII6	SO1GBII6	N250GB5.4KS	NSM8XS	3rd WiFi 1x2 BGN	3rd WiFi 1x2 BGN	N	N
AS5536-642G25Mn	PA	USA	LX.PAV0Y.003	AS5536-642G25Mn VHB32ATUS1 MC UMAbbm 2*1G/250/6L/CB_bgn_EN34	AAQL64	NLED15.6 WXGAG	UMA	N	SO1GBII6	SO1GBII6	N250GB5.4KS	NSM8XS	3rd WiFi 1x2 BGN	3rd WiFi 1x2 BGN	N	N
AS5536-642G25Mn	PA	ACLA-Spanish	LX.PAV0Y.002	AS5536-642G25Mn EM VHB32ATEA3 MC UMAbbm 2*1G/250/6L/CB_bgn_ES22	AAQL64	NLED15.6 WXGAG	UMA	N	SO1GBII6	SO1GBII6	N250GB5.4KS	NSM8XS	3rd WiFi 1x2 BGN	3rd WiFi 1x2 BGN	N	N
AS5536-642G25Mn	PA	ACLA-Portuguese	LX.PAV0Y.001	AS5536-642G25Mn EM VHB32ATXC1 MC UMAbbm 2*1G/250/6L/CB_bgn_XC22	AAQL64	NLED15.6 WXGAG	UMA	N	SO1GBII6	SO1GBII6	N250GB5.4KS	NSM8XS	3rd WiFi 1x2 BGN	3rd WiFi 1x2 BGN	N	N



# Aspire 5738DG/5738DZG Series

**NOTE:** All models have following common specifications: Card reader (5-in-1), LCD (N15.6WXGAGD), VGA Chip (M92XT), VRAM1 (512M-DDR3 (64\*16\*4)), ODD (NSM8XS), SB Chip (ICH9M), Battery (6CELL2.2), Adapter (65W), Camera (0.3M DV), Accessory1 (3D Glasses Clip type), Accessory2 (3D Glasses Wrap Type-Eastern)

Model	RO	Country	Acer Part No	Description	CPU	Memory 1/ Memory 2	HDD 1(GB)	Wireless LAN1	Bluetooth	Finger Print	NB Chipset	K/B	Power Cord
AS5738DG-754G50Mn	AAP	Australia/ New Zealand	LX.PKE02.002	AS5738DG-754G50Mn W7HP64ATAU1 MC M92XT512CFbb_2V3 2*2G/500_L/ BT/6L2.2/5R/ CB_n2_FP_0.3D_GC_GWE_HG_ ES61	C2DP7550	SO2GBII6	N500GB5.4KS	SP1x2MMW	BT 2.1	AES1610	PM45	US International (KB.I170A.056)	Australia w/label
AS5738DG-744G50Mn	EMEA	Germany	LX.PKE02.011	AS5738DG-744G50Mn W7HP64ATDE1 MC M92XT512CFbb_2V3 2*2G/500_L/ BT/6L2.2/5R/ CB_n2_FP_0.3D_GC_GWW_HG_ DE11	C2DP7450	SO2GBII6	N500GB5.4KS	SP1x2MMW	BT 2.1	AES1610	PM45	German (KB.I170A.040)	Continental
AS5738DG-874G50Mn	TWN	GCTWN	LX.PKE02.012	AS5738DG-874G50Mn W7HP64ATTW1 MC M92XT512CFbb_2V3 2*2G/500_L/ BT/6L2.2/5R/ CB_n2_FP_0.3D_GC_GWE_HG_ TC11	C2DP8700	SO2GBII6	N500GB5.4KS	SP1x2MMW	BT 2.1	AES1610	PM45	Chinese (KB.I170A.036)	US-110V (BSMI)
AS5738DG-874G50Mn	AAP	Philippines	LX.PKE02.013	AS5738DG-874G50Mn EM W7HP64EMATPH1 MC M92XT512CFbb_2V3 2*2G/500_L/ BT/6L2.2/5R/ CB_n2_FP_0.3D_GC_GWE_HG_ ES61	C2DP8700	SO2GBII6	N500GB5.4KS	SP1x2MMW	BT 2.1	AES1610	PM45	US International (KB.I170A.056)	US-110V
AS5738DG-664G32Mn	AAP	Australia/ New Zealand	LX.PKE02.003	AS5738DG-664G32Mn W7HP64ATAU1 MC M92XT512CFbb_2V3 2*2G/320/ BT/6L2.2/5R/ CB_n2_FP_0.3D_GC_GWE_HG_ ES61	C2DT6600	SO2GBII6	N320GB5.4KS	SP1x2MMW	BT 2.1	AES1610	PM45	US International (KB.I170A.056)	Australia w/label
AS5738DG-884G50Mn	AAP	Australia/ New Zealand	LX.PKE02.001	AS5738DG-884G50Mn W7HP64ATAU1 MC M92XT512CFbb_2V3 2*2G/500_L/ BT/6L2.2/5R/ CB_n2_FP_0.3D_GC_GWE_HG_ ES61	C2DP8800	SO2GBII6	N500GB5.4KS	SP1x2MMW	BT 2.1	AES1610	PM45	US International (KB.I170A.056)	Australia w/label
AS5738DG-884G50Mn	AAP	Thailand	LX.PKE02.010	AS5738DG-884G50Mn EM W7HP64EMATTH1 MC M92XT512CFbb_2V3 2*2G/500_L/ BT/6L2.2/5R/ CB_n2_FP_0.3D_GC_GWE_HG_ TH41	C2DP8800	SO2GBII6	N500GB5.4KS	SP1x2MMW	BT 2.1	AES1610	PM45	Thailand (KB.I170A.053)	US-110V
AS5738DG-754G50Mn	AAP	Thailand	LX.PKE02.009	AS5738DG-754G50Mn EM W7HP64EMATTH1 MC M92XT512CFbb_2V3 2*2G/500_L/ BT/6L2.2/5R/ CB_n2_FP_0.3D_GC_GWE_HG_ TH41	C2DP7550	SO2GBII6	N500GB5.4KS	SP1x2MMW	BT 2.1	AES1610	PM45	Thailand (KB.I170A.053)	US-110V
AS5738DG-744G50Mn	AAP	Thailand	LX.PKE02.008	AS5738DG-744G50Mn EM W7HP64EMATTH1 MC M92XT512CFbb_2V3 2*2G/500_L/ BT/6L2.2/5R/ CB_n2_FP_0.3D_GC_GWE_HG_ TH41	C2DP7450	SO2GBII6	N500GB5.4KS	SP1x2MMW	BT 2.1	AES1610	PM45	Thailand (KB.I170A.053)	US-110V

Model	RO	Country	Acer Part No	Description	CPU	Memory 1/ Memory 2	HDD 1(GB)	Wireless LAN1	Bluetooth	Finger Print	NB Chipset	K/B	Power Cord
AS5738DG-742G50Mn	AAP	Thailand	LX.PKE02.007	AS5738DG-742G50Mn EM W7HP64EMATTH1 MC M92XT512CFbb_2V3 1*2G/500_L/ BT/6L2.2/5R/ CB_n2_FP_0.3D_GC_GWE_HG_ TH41	C2DP7450	SO2GBII6/N	N500GB5.4KS	SP1x2MMW	BT 2.1	AES1610	PM45	Thailand (KB.I170A.053)	US-110V
AS5738DG-744G50Mn	AAP	Philippines	LX.PKE02.006	AS5738DG-744G50Mn EM W7HP64EMATPH1 MC M92XT512CFbb_2V3 2*2G/500_L/ BT/6L2.2/5R/ CB_n2_FP_0.3D_GC_GWE_HG_ ES61	C2DP7450	SO2GBII6	N500GB5.4KS	SP1x2MMW	BT 2.1	AES1610	PM45	US International (KB.I170A.056)	US-110V
AS5738DG-742G25Mn	AAP	Philippines	LX.PKE02.005	AS5738DG-742G25Mn EM W7HP64EMATPH1 MC M92XT512CFbb_2V3 1*2G/250/ BT/6L2.2/5R/ CB_n2_FP_0.3D_GC_GWE_HG_ ES61	C2DP7450	SO2GBII6/N	N250GB5.4KS	SP1x2MMW	BT 2.1	AES1610	PM45	US International (KB.I170A.056)	US-110V
AS5738DG-884G50Mn	AAP	Singapore	LX.PKE02.004	AS5738DG-884G50Mn W7HP64ATSG1 MC M92XT512CFbb_2V3 2*2G/500_L/ BT/6L2.2/5R/ CB_n2_FP_0.3D_GC_GWE_HG_ ES61	C2DP8800	SO2GBII6	N500GB5.4KS	SP1x2MMW	BT 2.1	AES1610	PM45	US International (KB.I170A.056)	UK
AS5738DG-664G50Mn	EMEA	Norway	LX.PKD02.056	AS5738DG-664G50Mn W7HP64ATNO3 MC M92XT512Cbb_2V3 2*2G/500_L/ BT/6L2.2/5R/ CB_n2_0.3D_GC_GWW_HG_EN S1	C2DT6600	SO2GBII6	N500GB5.4KS	SP1x2MMW	BT 2.1	N	PM45	Nordic (KB.I170A.045)	Danish/Continental
AS5738DG-664G32Mn	PA	USA	LX.PKD02.047	AS5738DG-664G32Mn W7HP64ATUS1 MC M92XT512Cbb_2V3 2*2G/320/ 6L2.2/5R/ CB_n2_0.3D_GC_GWW_HG_FR B1	C2DT6600	SO2GBII6	N320GB5.4KS	SP1x2MMW	N	N	PM45	US International (KB.I170A.056)	US-110V
AS5738DG-664G32Mn	EMEA	Hungary	LX.PKD02.034	AS5738DG-664G32Mn W7HP64ATHU1 MC M92XT512Cbb_2V3 2*2G/320/ 6L2.2/5R/ CB_n2_0.3D_GC_GWW_HG_HU 11	C2DT6600	SO2GBII6	N320GB5.4KS	SP1x2MMW	N	N	PM45	Hungarian (KB.I170A.042)	Continental
AS5738DG-664G50Mn	EMEA	Czech	LX.PKD02.055	AS5738DG-664G50Mn W7HP64ATCZ2 MC M92XT512Cbb_2V3 2*2G/500_L/ BT/6L2.2/5R/ CB_n2_0.3D_GC_GWW_HG_SK1 1	C2DT6600	SO2GBII6	N500GB5.4KS	SP1x2MMW	BT 2.1	N	PM45	CZ/SK (KB.I170A.035)	Continental
AS5738DG-664G32Mn	EMEA	Eastern Europe	LX.PKD02.062	AS5738DG-664G32Mn W7HP64ATEU5 MC M92XT512Cbb_2V3 2*2G/320/BT/ 6L2.2/5R/ CB_n2_0.3D_GC_GWW_HG_RO 11	C2DT6600	SO2GBII6	N320GB5.4KS	SP1x2MMW	BT 2.1	N	PM45	US International (KB.I170A.056)	Continental
AS5738DG-664G32Mn	EMEA	Holland	LX.PKD02.040	AS5738DG-664G32Mn W7HP64ATNL1 MC M92XT512Cbb_2V3 2*2G/320/ 6L2.2/5R/ CB_n2_0.3D_GC_GWW_HG_NL1 1	C2DT6600	SO2GBII6	N320GB5.4KS	SP1x2MMW	N	N	PM45	US International (KB.I170A.056)	Continental

Model	RO	Country	Acer Part No	Description	CPU	Memory 1/ Memory 2	HDD 1(GB)	Wireless LAN1	Bluetooth	Finger Print	NB Chipset	K/B	Power Cord
AS5738DG-873G32Mn	EMEA	Poland	LX.PKD02.053	AS5738DG-873G32Mn W7HP64ATPL1 MC M92XT512Cbb_2V3 2*2G/320/ 6L2.2/5R/ CB_n2_0.3D_GC_GWW_HG_PL1 1	C2DP8700	SO2GBII6	N320GB5.4KS	SP1x2MMW	N	N	PM45	US International (KB.I170A.056)	Continental
AS5738DG-664G50Mn	EMEA	France	LX.PKD02.043	AS5738DG-664G50Mn W7HP64ATFR1 MC M92XT512Cbb_2V3 2*2G/500_L/ 6L2.2/5R/ CB_n2_0.3D_GC_GWW_HG_FR2 1	C2DT6600	SO2GBII6	N500GB5.4KS	SP1x2MMW	N	N	PM45	French (KB.I170A.039)	Continental
AS5738DG-663G32Mn	EMEA	Poland	LX.PKD02.059	AS5738DG-663G32Mn W7HP64ATPL1 MC M92XT512Cbb_2V3 2G+1G/320/ 6L2.2/5R/ CB_n2_0.3D_GC_GWW_HG_PL1 1	C2DT6600	SO2GBII6	N320GB5.4KS	SP1x2MMW	N	N	PM45	US International (KB.I170A.056)	Continental
AS5738DG-664G32Mn	EMEA	Middle East	LX.PKD02.048	AS5738DG-664G32Mn EM W7HP64EMATME2 MC M92XT512Cbb_2V3 2*2G/320/BT/ 6L2.2/5R/ CB_n2_0.3D_GC_GWW_HG_AR 21	C2DT6600	SO2GBII6	N320GB5.4KS	SP1x2MMW	BT 2.1	N	PM45	Arabic (KB.I170A.032)	UK and US-110V
AS5738DG-664G32Mn	EMEA	Portugal	LX.PKD02.031	AS5738DG-664G32Mn W7HP64ATPT1 MC M92XT512Cbb_2V3 2*2G/320/ 6L2.2/5R/ CB_n2_0.3D_GC_GWW_HG_PT1 1	C2DT6600	SO2GBII6	N320GB5.4KS	SP1x2MMW	N	N	PM45	Portuguese (KB.I170A.047)	Continental
AS5738DG-664G32Mn	EMEA	Belgium	LX.PKD02.038	AS5738DG-664G32Mn W7HP64ATBE1 MC M92XT512Cbb_2V3 2*2G/320/ 6L2.2/5R/ CB_n2_0.3D_GC_GWW_HG_NL1 1	C2DT6600	SO2GBII6	N320GB5.4KS	SP1x2MMW	N	N	PM45	Belgium (KB.I170A.033)	Continental
AS5738DG-664G50Mn	EMEA	Eastern Europe	LX.PKD02.061	AS5738DG-664G50Mn W7HP64ATEU5 MC M92XT512Cbb_2V3 2*2G/500_L/ 6L2.2/5R/ CB_n2_0.3D_GC_GWW_HG_RO 11	C2DT6600	SO2GBII6	N500GB5.4KS	SP1x2MMW	N	N	PM45	US International (KB.I170A.056)	Continental
AS5738DG-874G50Mn	AAP	Philippines	LX.PKD02.060	AS5738DG-874G50Mn EM W7HP64EMATPH1 MC M92XT512Cbb_2V3 2*2G/500_L/ BT/6L2.2/5R/ CB_n2_0.3D_GC_GWE_HG_ES6 1	C2DP8700	SO2GBII6	N500GB5.4KS	SP1x2MMW	BT 2.1	N	PM45	US International (KB.I170A.056)	US-110V
AS5738DG-664G32Mi	EMEA	Ukraine	LX.PKD02.002	AS5738DG-664G32Mi W7HP64RUJATUK1 MC M92XT512Cbb_2V3 2*2G/320/ 6L2.2/5R/ CB_abg_0.3D_GC_GWW_HG_R U61	C2DT6600	SO2GBII6	N320GB5.4KS	SP1x2MABG	N	N	PM45	Russian (KB.I170A.048)	Continental
AS5738DG-664G32Mn	PA	USA	LX.PKD02.050	AS5738DG-664G32Mn W7HP64ATUS1 MC M92XT512Cbb_2V3 2*2G/320/ 6L2.2/5R/ CB_n2_0.3D_GC_GWW_HG_FR B1duplication with oth	C2DT6600	SO2GBII6	N320GB5.4KS	SP1x2MMW	N	N	PM45	US International (KB.I170A.056)	US-110V

Model	RO	Country	Acer Part No	Description	CPU	Memory 1/ Memory 2	HDD 1(GB)	Wireless LAN1	Bluetooth	Finger Print	NB Chipset	K/B	Power Cord
AS5738DG-664G32Mn	EMEA	Middle East	LX.PKD02.012	AS5738DG-664G32Mn EM W7HP64EMATME9 MC M92XT512Cbb_2V3 2*2G/320/ 6L2.2/5R/ CB_n2_0.3D_GC_GWW_HG_ES8 1	C2DT6600	SO2GBI16	N320GB5.4KS	SP1x2MMW	N	N	PM45	FR/Arabic (KB.I170A.038)	Continental
AS5738DG-664G32Mn	EMEA	Greece	LX.PKD02.039	AS5738DG-664G32Mn W7HP64ATGR1 MC M92XT512Cbb_2V3 2*2G/320/ 6L2.2/5R/ CB_n2_0.3D_GC_GWW_HG_EL3 1	C2DT6600	SO2GBI16	N320GB5.4KS	SP1x2MMW	N	N	PM45	Greek (KB.I170A.041)	Continental
AS5738DG-664G32Mn	PA	Canada	LX.PKD02.045	AS5738DG-664G32Mn W7HP64ATCA2 MC M92XT512Cbb_2V3 2*2G/320/ 6L2.2/5R/ CB_n2_0.3D_GC_GWW_HG_FR8 1	C2DT6600	SO2GBI16	N320GB5.4KS	SP1x2MMW	N	N	PM45	US w/ Canadian French (KB.I170A.058)	US-110V
AS5738DG-664G32Mn	PA	Canada	LX.PKD02.046	AS5738DG-664G32Mn W7HP64ATCA2 MC M92XT512Cbb_2V3 2*2G/320/ 6L2.2/5R/ CB_n2_0.3D_GC_GWW_HG_FR8 2	C2DT6600	SO2GBI16	N320GB5.4KS	SP1x2MMW	N	N	PM45	US w/ Canadian French (KB.I170A.058)	US-110V
AS5738DG-664G32Mn	EMEA	Middle East	LX.PKD02.013	AS5738DG-664G32Mn EM W7HP64EMATME4 MC M92XT512Cbb_2V3 2*2G/320/ 6L2.2/5R/ CB_n2_0.3D_GC_GWW_HG_ES6 1	C2DT6600	SO2GBI16	N320GB5.4KS	SP1x2MMW	N	N	PM45	Russian (KB.I170A.048)	Continental
AS5738DG-664G32Mn	EMEA	Switzerland	LX.PKD02.041	AS5738DG-664G32Mn W7HP64ATCH1 MC M92XT512Cbb_2V3 2*2G/320/ 6L2.2/5R/ CB_n2_0.3D_GC_GWW_HG_IT4 1	C2DT6600	SO2GBI16	N320GB5.4KS	SP1x2MMW	N	N	PM45	Swiss/G (KB.I170A.052)	Swiss
AS5738DG-664G32Mn	EMEA	Luxembourg	LX.PKD02.019	AS5738DG-664G32Mn W7HP64ATLU3 MC M92XT512Cbb_2V3 2*2G/320/ 6L2.2/5R/ CB_n2_0.3D_GC_GWW_HG_IT4 1	C2DT6600	SO2GBI16	N320GB5.4KS	SP1x2MMW	N	N	PM45	Swiss/G (KB.I170A.052)	Continental
AS5738DG-664G32Mn	EMEA	UK	LX.PKD02.027	AS5738DG-664G32Mn W7HP64ATGB1 MC M92XT512Cbb_2V3 2*2G/320/ 6L2.2/5R/ CB_n2_0.3D_GC_GWW_HG_EN 11	C2DT6600	SO2GBI16	N320GB5.4KS	SP1x2MMW	N	N	PM45	UK (KB.I170A.055)	UK
AS5738DG-664G32Mn	EMEA	Cyprus	LX.PKD02.020	AS5738DG-664G32Mn W7HP64ATCY1 MC M92XT512Cbb_2V3 2*2G/320/ 6L2.2/5R/ CB_n2_0.3D_GC_GWW_HG_ES6 1	C2DT6600	SO2GBI16	N320GB5.4KS	SP1x2MMW	N	N	PM45	UK (KB.I170A.055)	UK
AS5738DG-664G32Mn	EMEA	Middle East	LX.PKD02.014	AS5738DG-664G32Mn EM W7HP64EMATME2 MC M92XT512Cbb_2V3 2*2G/320/ 6L2.2/5R/ CB_n2_0.3D_GC_GWW_HG_AR 11	C2DT6600	SO2GBI16	N320GB5.4KS	SP1x2MMW	N	N	PM45	Arabic (KB.I170A.032)	UK and US-110V

Model	RO	Country	Acer Part No	Description	CPU	Memory 1/ Memory 2	HDD 1(GB)	Wireless LAN1	Bluetooth	Finger Print	NB Chipset	K/B	Power Cord
AS5738DG-664G32Mn	EMEA	Czech	LX.PKD02.023	AS5738DG-664G32Mn W7HP64ATCZ2 MC M92XT512Cbb_2V3 2*2G/320/ 6L2.2/5R/ CB_n2_0.3D_GC_GWW_HG_SK1 1	C2DT6600	SO2GBII6	N320GB5.4KS	SP1x2MMW	N	N	PM45	CZ/SK (KB.I170A.035)	Continental
AS5738DG-664G32Mn	EMEA	Italy	LX.PKD02.021	AS5738DG-664G32Mn W7HP64ATIT1 MC M92XT512Cbb_2V3 2*2G/320/ 6L2.2/5R/ CB_n2_0.3D_GC_GWW_HG_IT11	C2DT6600	SO2GBII6	N320GB5.4KS	SP1x2MMW	N	N	PM45	Italian (KB.I170A.043)	Italian
AS5738DG-664G32Mn	EMEA	Norway	LX.PKD02.024	AS5738DG-664G32Mn W7HP64ATNO1 MC M92XT512Cbb_2V3 2*2G/320/ 6L2.2/5R/ CB_n2_0.3D_GC_GWW_HG_NO 11	C2DT6600	SO2GBII6	N320GB5.4KS	SP1x2MMW	N	N	PM45	Norwegian (KB.I170A.046)	Continental
AS5738DG-664G32Mn	EMEA	Denmark	LX.PKD02.035	AS5738DG-664G32Mn W7HP64ATDK1 MC M92XT512Cbb_2V3 2*2G/320/ 6L2.2/5R/ CB_n2_0.3D_GC_GWW_HG_NO 11	C2DT6600	SO2GBII6	N320GB5.4KS	SP1x2MMW	N	N	PM45	Danish (KB.I170A.037)	Danish
AS5738DG-664G32Mn	EMEA	Eastern Europe	LX.PKD02.025	AS5738DG-664G32Mn W7HP64ATEU4 MC M92XT512Cbb_2V3 2*2G/320/ 6L2.2/5R/ CB_n2_0.3D_GC_GWW_HG_SV2 1	C2DT6600	SO2GBII6	N320GB5.4KS	SP1x2MMW	N	N	PM45	Sweden (KB.I170A.051)	Continental
AS5738DG-664G32Mn	EMEA	Finland	LX.PKD02.022	AS5738DG-664G32Mn W7HP64ATFI2 MC M92XT512Cbb_2V3 2*2G/320/ 6L2.2/5R/ CB_n2_0.3D_GC_GWW_HG_FI11	C2DT6600	SO2GBII6	N320GB5.4KS	SP1x2MMW	N	N	PM45	Sweden (KB.I170A.051)	Continental
AS5738DG-664G32Mn	EMEA	Sweden	LX.PKD02.018	AS5738DG-664G32Mn W7HP64ATSE1 MC M92XT512Cbb_2V3 2*2G/320/ 6L2.2/5R/ CB_n2_0.3D_GC_GWW_HG_FI11	C2DT6600	SO2GBII6	N320GB5.4KS	SP1x2MMW	N	N	PM45	Sweden (KB.I170A.051)	Continental
AS5738DG-664G32Mn	EMEA	Germany	LX.PKD02.030	AS5738DG-664G32Mn W7HP64ATDE1 MC M92XT512Cbb_2V3 2*2G/320/ 6L2.2/5R/ CB_n2_0.3D_GC_GWW_HG_DE 11	C2DT6600	SO2GBII6	N320GB5.4KS	SP1x2MMW	N	N	PM45	German (KB.I170A.040)	Continental
AS5738DG-664G32Mn	EMEA	Austria	LX.PKD02.026	AS5738DG-664G32Mn W7HP64ATAT1 MC M92XT512Cbb_2V3 2*2G/320/ 6L2.2/5R/ CB_n2_0.3D_GC_GWW_HG_DE 61	C2DT6600	SO2GBII6	N320GB5.4KS	SP1x2MMW	N	N	PM45	German (KB.I170A.040)	Continental
AS5738DG-664G32Mn	EMEA	Denmark	LX.PKD02.032	AS5738DG-664G32Mn W7HP64ATDK2 MC M92XT512Cbb_2V3 2*2G/320/ 6L2.2/5R/ CB_n2_0.3D_GC_GWW_HG_EN S1	C2DT6600	SO2GBII6	N320GB5.4KS	SP1x2MMW	N	N	PM45	Nordic (KB.I170A.045)	Danish/Continental
AS5738DG-664G32Mn	EMEA	Norway	LX.PKD02.029	AS5738DG-664G32Mn W7HP64ATNO3 MC M92XT512Cbb_2V3 2*2G/320/ 6L2.2/5R/ CB_n2_0.3D_GC_GWW_HG_EN S1	C2DT6600	SO2GBII6	N320GB5.4KS	SP1x2MMW	N	N	PM45	Nordic (KB.I170A.045)	Danish/Continental

Model	RO	Country	Acer Part No	Description	CPU	Memory 1/ Memory 2	HDD 1(GB)	Wireless LAN1	Bluetooth	Finger Print	NB Chipset	K/B	Power Cord
AS5738DG-664G32Mn	EMEA	Spain	LX.PKD02.033	AS5738DG-664G32Mn W7HP64ATES1 MC M92XT512Cbb_2V3 2*2G/320/ 6L2.2/5R/ CB_n2_0.3D_GC_GWW_HG_ES5 1	C2DT6600	SO2GBI16	N320GB5.4KS	SP1x2MMW	N	N	PM45	Spanish (KB.I170A.050)	Continental
AS5738DG-664G32Mn	EMEA	Eastern Europe	LX.PKD02.017	AS5738DG-664G32Mn W7HP64ATEU7 MC M92XT512Cbb_2V3 2*2G/320/ 6L2.2/5R/ CB_n2_0.3D_GC_GWW_HG_EN Q1	C2DT6600	SO2GBI16	N320GB5.4KS	SP1x2MMW	N	N	PM45	SLO/CRO (KB.I170A.049)	Continental
AS5738DG-664G32Mn	EMEA	Eastern Europe	LX.PKD02.016	AS5738DG-664G32Mn W7HP64ATEU7 MC M92XT512Cbb_2V3 2*2G/320/ 6L2.2/5R/ CB_n2_0.3D_GC_GWW_HG_SL1 1	C2DT6600	SO2GBI16	N320GB5.4KS	SP1x2MMW	N	N	PM45	SLO/CRO (KB.I170A.049)	Continental
AS5738DG-664G32Mn	EMEA	Middle East	LX.PKD02.015	AS5738DG-664G32Mn EM W7HP64EMATME6 MC M92XT512Cbb_2V3 2*2G/320/ 6L2.2/5R/ CB_n2_0.3D_GC_GWW_HG_ES6 1	C2DT6600	SO2GBI16	N320GB5.4KS	SP1x2MMW	N	N	PM45	US International (KB.I170A.056)	UK
AS5738DG-664G32Mn	PA	USA	LX.PKD02.044	AS5738DG-664G32Mn W7HP64ATUS1 MC M92XT512Cbb_2V3 2*2G/320/ 6L2.2/5R/ CB_n2_0.3D_GC_GWW_HG_FR B2	C2DT6600	SO2GBI16	N320GB5.4KS	SP1x2MMW	N	N	PM45	US International (KB.I170A.056)	US-110V
AS5738DG-664G32Mn	EMEA	Eastern Europe	LX.PKD02.042	AS5738DG-664G32Mn W7HP64ATEU5 MC M92XT512Cbb_2V3 2*2G/320/ 6L2.2/5R/ CB_n2_0.3D_GC_GWW_HG_PL7 1	C2DT6600	SO2GBI16	N320GB5.4KS	SP1x2MMW	N	N	PM45	US International (KB.I170A.056)	Continental
AS5738DG-664G32Mn	EMEA	Poland	LX.PKD02.037	AS5738DG-664G32Mn W7HP64ATPL1 MC M92XT512Cbb_2V3 2*2G/320/ 6L2.2/5R/ CB_n2_0.3D_GC_GWW_HG_PL1 1	C2DT6600	SO2GBI16	N320GB5.4KS	SP1x2MMW	N	N	PM45	US International (KB.I170A.056)	Continental
AS5738DG-664G32Mn	EMEA	Eastern Europe	LX.PKD02.036	AS5738DG-664G32Mn W7HP64ATEU5 MC M92XT512Cbb_2V3 2*2G/320/ 6L2.2/5R/ CB_n2_0.3D_GC_GWW_HG_RO 11	C2DT6600	SO2GBI16	N320GB5.4KS	SP1x2MMW	N	N	PM45	US International (KB.I170A.056)	Continental
AS5738DG-664G32Mn	EMEA	France	LX.PKD02.028	AS5738DG-664G32Mn W7HP64ATFR1 MC M92XT512Cbb_2V3 2*2G/320/ 6L2.2/5R/ CB_n2_0.3D_GC_GWW_HG_FR2 1	C2DT6600	SO2GBI16	N320GB5.4KS	SP1x2MMW	N	N	PM45	French (KB.I170A.039)	Continental
AS5738DG-664G32Mn	EMEA	Algeria	LX.PKD02.003	AS5738DG-664G32Mn EM W7HP64EMATDZ1 MC M92XT512Cbb_2V3 2*2G/320/ 6L2.2/5R/ CB_n2_0.3D_GC_GWW_HG_ES8 1	C2DT6600	SO2GBI16	N320GB5.4KS	SP1x2MMW	N	N	PM45	FR/Arabic (KB.I170A.038)	Continental

Model	RO	Country	Acer Part No	Description	CPU	Memory 1/ Memory 2	HDD 1(GB)	Wireless LAN1	Bluetooth	Finger Print	NB Chipset	K/B	Power Cord
AS5738DG-664G32Mn	EMEA	South Africa	LX.PKD02.004	AS5738DG-664G32Mn EM W7HP64EMATZA1 MC M92XT512Cbb_2V3 2*2G/320/ 6L2.2/5R/ CB_n2_0.3D_GC_GWW_HG_ES8 1	C2DT6600	SO2GBI16	N320GB5.4KS	SP1x2MMW	N	N	PM45	French (KB.I170A.039)	Continental
AS5738DG-664G32Mi	EMEA	Russia	LX.PKD02.001	AS5738DG-664G32Mi W7HP64RUJATRU1 MC M92XT512Cbb_2V3 2*2G/320/ 6L2.2/5R/ CB_abg_0.3D_GC_GWW_HG_R U11	C2DT6600	SO2GBI16	N320GB5.4KS	SP1x2MABG	N	N	PM45	Russian (KB.I170A.048)	Continental
AS5738DG-664G32Mn	EMEA	Middle East	LX.PKD02.009	AS5738DG-664G32Mn EM W7HP64EMATME3 MC M92XT512Cbb_2V3 2*2G/320/ 6L2.2/5R/ CB_n2_0.3D_GC_GWW_HG_ES8 1	C2DT6600	SO2GBI16	N320GB5.4KS	SP1x2MMW	N	N	PM45	French (KB.I170A.039)	Continental
AS5738DG-664G32Mn	EMEA	South Africa	LX.PKD02.007	AS5738DG-664G32Mn EM W7HP64EMATZA4 MC M92XT512Cbb_2V3 2*2G/320/ 6L2.2/5R/ CB_n2_0.3D_GC_GWW_HG_ES6 1	C2DT6600	SO2GBI16	N320GB5.4KS	SP1x2MMW	N	N	PM45	US International (KB.I170A.056)	UK
AS5738DG-664G32Mn	EMEA	South Africa	LX.PKD02.011	AS5738DG-664G32Mn EM W7HP64EMATZA2 MC M92XT512Cbb_2V3 2*2G/320/ 6L2.2/5R/ CB_n2_0.3D_GC_GWW_HG_ES6 1	C2DT6600	SO2GBI16	N320GB5.4KS	SP1x2MMW	N	N	PM45	US International (KB.I170A.056)	AF
AS5738DG-664G32Mn	EMEA	Middle East	LX.PKD02.006	AS5738DG-664G32Mn EM W7HP64EMATME2 MC M92XT512Cbb_2V3 2*2G/320/ 6L2.2/5R/ CB_n2_0.3D_GC_GWW_HG_ES6 1	C2DT6600	SO2GBI16	N320GB5.4KS	SP1x2MMW	N	N	PM45	Arabic (KB.I170A.032)	UK and US-110V
AS5738DG-664G32Mn	EMEA	Middle East	LX.PKD02.008	AS5738DG-664G32Mn EM W7HP64EMATME2 MC M92XT512Cbb_2V3 2*2G/320/ 6L2.2/5R/ CB_n2_0.3D_GC_GWW_HG_AR 21	C2DT6600	SO2GBI16	N320GB5.4KS	SP1x2MMW	N	N	PM45	Arabic (KB.I170A.032)	UK and US-110V
AS5738DG-664G32Mn	EMEA	Turkey	LX.PKD02.010	AS5738DG-664G32Mn EM W7HP64EMATTR1 MC M92XT512Cbb_2V3 2*2G/320/ 6L2.2/5R/ CB_n2_0.3D_GC_GWW_HG_TR3 1	C2DT6600	SO2GBI16	N320GB5.4KS	SP1x2MMW	N	N	PM45	Turkish (KB.I170A.054)	Continental
AS5738DG-664G32Mn	EMEA	Middle East	LX.PKD02.005	AS5738DG-664G32Mn EM W7HP64EMATME4 MC M92XT512Cbb_2V3 2*2G/320/ 6L2.2/5R/ CB_n2_0.3D_GC_GWW_HG_RU 61	C2DT6600	SO2GBI16	N320GB5.4KS	SP1x2MMW	N	N	PM45	Russian (KB.I170A.048)	Continental
AS5738DG-664G32Mn	EMEA	Latvia	LX.PKD02.058	AS5738DG-664G32Mn W7HP64ATLV1 MC M92XT512Cbb_2V3 2*2G/320/BT/ 6L2.2/5R/ CB_n2_0.3D_GC_GWW_HG_RU 22	C2DT6600	SO2GBI16	N320GB5.4KS	SP1x2MMW	BT 2.1	N	PM45	Russian (KB.I170A.048)	Continental

Model	RO	Country	Acer Part No	Description	CPU	Memory 1/ Memory 2	HDD 1(GB)	Wireless LAN1	Bluetooth	Finger Print	NB Chipset	K/B	Power Cord
AS5738DG-882G32Mn	CHINA	Hong Kong	LX.PKD02.057	AS5738DG-882G32Mn W7HP64ATHK2 MC M92XT512Cbb_2V3 1*2G/320/BT/ 6L2.2/5R/ CB_n2_0.3D_GC_GWE_HG_ZH3 4	C2DP8800	SO2GBII6/N	N320GB5.4KS	SP1x2MMW	BT 2.1	N	PM45	US International (KB.I170A.056)	UK
AS5738DG-874G50Mn	EMEA	Poland	LX.PKD02.054	AS5738DG-874G50Mn W7HP64ATPL1 MC M92XT512Cbb_2V3 2*2G/500_L/ 6L2.2/5R/ CB_n2_0.3D_GC_GWW_HG_PL1 1	C2DP8700	SO2GBII6	N500GB5.4KS	SP1x2MMW	N	N	PM45	US International (KB.I170A.056)	Continental
AS5738DG-882G32Mn	CHINA	China	LX.PKD01.001	AS5738DG-882G32Mn W7HB64SCATCN1 MC M92XT512Cbb_2V3 1*2G/320/BT/ 6L2.2/5R/ CB_n2_0.3D_GC_GWE_HG_SC1 3	C2DP8800	SO2GBII6/N	N320GB5.4KS	SP1x2MMW	BT 2.1	N	PM45	US International (KB.I170A.056)	PRC
AS5738DG-664G32Mi	EMEA	Russia	LX.PKD02.052	AS5738DG-664G32Mi W7HP64RUATRU1 MC M92XT512Cbb_2V3 2*2G/320/BT/ 6L2.2/5R/ CB_abg_0.3D_GC_GWW_HG_R U11	C2DT6600	SO2GBII6	N320GB5.4KS	SP1x2MABG	BT 2.1	N	PM45	Russian (KB.I170A.048)	Continental
AS5738DG-744G32Mn	EMEA	Spain	LX.PKD02.051	AS5738DG-744G32Mn W7HP64ATES1 MC M92XT512Cbb_2V3 2*2G/320/ 6L2.2/5R/ CB_n2_0.3D_GC_GWW_HG_ES5 1	C2DP7450	SO2GBII6	N320GB5.4KS	SP1x2MMW	N	N	PM45	Spanish (KB.I170A.050)	Continental
AS5738DG-664G50Mn	EMEA	Poland	LX.PKD02.049	AS5738DG-664G50Mn W7HP64ATPL1 MC M92XT512Cbb_2V3 2*2G/500_L/ 6L2.2/5R/ CB_n2_0.3D_GC_GWW_HG_PL1 1	C2DT6600	SO2GBII6	N500GB5.4KS	SP1x2MMW	N	N	PM45	US International (KB.I170A.056)	Continental
AS5738DZG-434G32Mn	AAP	Australia/ New Zealand	LX.PKG02.001	AS5738DZG-434G32Mn W7HP64ATAU1 MC M92XT512Cfbb_2V3 2*2G/320/ 6L2.2/5R/ CB_bgn_FP_0.3D_GC_GWE_HG _ES61	PMDT4300	SO2GBII6	N320GB5.4KS	3rd WiFi 1x2 BGN	N	AES1610	GM45	US International (KB.I170A.056)	Australia w/label
AS5738DZG-434G32Mn	AAP	Australia/ New Zealand	LX.PKG02.002	AS5738DZG-434G32Mn W7HP64ATAU1 MC M92XT512Cfbb_2V3 2*2G/320/ BT/6L2.2/5R/ CB_bgn_FP_0.3D_GC_GWE_HG _ES61	PMDT4300	SO2GBII6	N320GB5.4KS	3rd WiFi 1x2 BGN	BT 2.1	AES1610	GM45	US International (KB.I170A.056)	Australia w/label
AS5738DZG-432G25Mn	AAP	Australia/ New Zealand	LX.PKG02.003	AS5738DZG-432G25Mn W7HP64ATAU1 MC M92XT512Cfbb_2V3 1*2G/250/ 6L2.2/5R/ CB_bgn_FP_0.3D_GC_GWE_HG _ES61	PMDT4300	SO2GBII6/N	N250GB5.4KS	3rd WiFi 1x2 BGN	N	AES1610	GM45	US International (KB.I170A.056)	Australia w/label
AS5738DZG-434G50Mn	EMEA	Eastern Europe	LX.PKF02.058	AS5738DZG-434G50Mn W7HP64ATEU5 MC M92XT512Cbb_2V3 2*2G/500_L/ 6L2.2/5R/ CB_bgn_0.3D_GC_GWW_HG_R O11	PMDT4300	SO2GBII6	N500GB5.4KS	3rd WiFi 1x2 BGN	N	N	GM45	US International (KB.I170A.056)	Continental



Model	RO	Country	Acer Part No	Description	CPU	Memory 1/ Memory 2	HDD 1(GB)	Wireless LAN1	Bluetooth	Finger Print	NB Chipset	K/B	Power Cord
AS5738DZG-434G32Mn	EMEA	Switzerland	LX.PKF02.022	AS5738DZG-434G32Mn W7HP64ATCH1 MC M92XT512Cbb_2V3 2*2G/320/ 6L2.2/5R/ CB_bgn_0.3D_GC_GWW_HG_IT 41	PMDT4300	SO2GBI16	N320GB5.4KS	3rd WiFi 1x2 BGN	N	N	GM45	Swiss/G (KB.I170A.052)	Swiss
AS5738DZG-433G32Mn	EMEA	Greece	LX.PKF02.056	AS5738DZG-433G32Mn W7HP64ATGR1 MC M92XT512Cbb_2V3 2G+1G/320/ 6L2.2/5R/ CB_bgn_0.3D_GC_GWW_HG_EL 31	PMDT4300	SO2GBI16	N320GB5.4KS	3rd WiFi 1x2 BGN	N	N	GM45	Greek (KB.I170A.041)	Continental
AS5738DZG-433G32Mn	EMEA	Israel	LX.PKF02.054	AS5738DZG-433G32Mn W7HP64ATIL1 MC M92XT512Cbb_2V3 2G+1G/320/ 6L2.2/5R/ CB_bgn_0.3D_GC_GWW_HG_H E31	PMDT4300	SO2GBI16	N320GB5.4KS	3rd WiFi 1x2 BGN	N	N	GM45	US International w/ Hebrew (KB.I170A.057)	Israel
AS5738DZG-434G32Mn	EMEA	Ukraine	LX.PKF02.002	AS5738DZG-434G32Mn W7HP64RUATUK1 MC M92XT512Cbb_2V3 2*2G/320/ 6L2.2/5R/ CB_bgn_0.3D_GC_GWW_HG_R U61	PMDT4300	SO2GBI16	N320GB5.4KS	3rd WiFi 1x2 BGN	N	N	GM45	Russian (KB.I170A.048)	Continental
AS5738DZG-434G32Mn	EMEA	Eastern Europe	LX.PKF02.016	AS5738DZG-434G32Mn W7HP64ATEU7 MC M92XT512Cbb_2V3 2*2G/320/ 6L2.2/5R/ CB_bgn_0.3D_GC_GWW_HG_SL 11	PMDT4300	SO2GBI16	N320GB5.4KS	3rd WiFi 1x2 BGN	N	N	GM45	SLO/CRO (KB.I170A.049)	Continental
AS5738DZG-434G32Mn	EMEA	Eastern Europe	LX.PKF02.059	AS5738DZG-434G32Mn W7HP64ATEU5 MC M92XT512Cbb_2V3 2*2G/320/BT/ 6L2.2/5R/ CB_bgn_0.3D_GC_GWW_HG_R O11	PMDT4300	SO2GBI16	N320GB5.4KS	3rd WiFi 1x2 BGN	BT 2.1	N	GM45	US International (KB.I170A.056)	Continental
AS5738DZG-434G32Mn	EMEA	Denmark	LX.PKF02.027	AS5738DZG-434G32Mn W7HP64ATDK2 MC M92XT512Cbb_2V3 2*2G/320/ 6L2.2/5R/ CB_bgn_0.3D_GC_GWW_HG_E NS1	PMDT4300	SO2GBI16	N320GB5.4KS	3rd WiFi 1x2 BGN	N	N	GM45	Nordic (KB.I170A.045)	Danish/Continental
AS5738DZG-433G32Mn	EMEA	Italy	LX.PKF02.052	AS5738DZG-433G32Mn W7HP64ATIT1 MC M92XT512Cbb_2V3 2G+1G/320/ 6L2.2/5R/ CB_bgn_0.3D_GC_GWW_HG_IT 11	PMDT4300	SO2GBI16	N320GB5.4KS	3rd WiFi 1x2 BGN	N	N	GM45	Italian (KB.I170A.043)	Italian
AS5738DZG-434G32Mn	EMEA	South Africa	LX.PKF02.047	AS5738DZG-434G32Mn EM W7HP64EMATZ2A2 MC M92XT512Cbb_2V3 2*2G/320/BT/ 6L2.2/5R/ CB_bgn_0.3D_GC_GWW_HG_ES 61	PMDT4300	SO2GBI16	N320GB5.4KS	3rd WiFi 1x2 BGN	BT 2.1	N	GM45	US International (KB.I170A.056)	AF
AS5738DZG-434G50Mn	EMEA	UK	LX.PKF02.045	AS5738DZG-434G50Mn W7HP64ATGB1 MC M92XT512Cbb_2V3 2*2G/500_L/ 6L2.2/5R/ CB_bgn_0.3D_GC_GWW_HG_E N11	PMDT4300	SO2GBI16	N500GB5.4KS	3rd WiFi 1x2 BGN	N	N	GM45	UK (KB.I170A.055)	<b>UK</b>

Model	RO	Country	Acer Part No	Description	CPU	Memory 1/ Memory 2	HDD 1(GB)	Wireless LAN1	Bluetooth	Finger Print	NB Chipset	K/B	Power Cord
AS5738DZG-434G50Mn	EMEA	France	LX.PKF02.044	AS5738DZG-434G50Mn W7HP64ATFR1 MC M92XT512Cbb_2V3 2*2G/500_L/ 6L2.2/5R/ CB_bgn_0.3D_GC_GWW_HG_FR 21	PMDT4300	SO2GBI16	N500GB5.4KS	3rd WiFi 1x2 BGN	N	N	GM45	French (KB.I170A.039)	Continental
AS5738DZG-433G32Mn	EMEA	Poland	LX.PKF02.057	AS5738DZG-433G32Mn W7HP64ATPL1 MC M92XT512Cbb_2V3 2*2G/320/ 6L2.2/5R/ CB_bgn_0.3D_GC_GWW_HG_PL 11	PMDT4300	SO2GBI16	N320GB5.4KS	3rd WiFi 1x2 BGN	N	N	GM45	US International (KB.I170A.056)	Continental
AS5738DZG-434G50Mn	EMEA	Spain	LX.PKF02.043	AS5738DZG-434G50Mn W7HP64ATES1 MC M92XT512Cbb_2V3 2*2G/500_L/ 6L2.2/5R/ CB_bgn_0.3D_GC_GWW_HG_ES 51	PMDT4300	SO2GBI16	N500GB5.4KS	3rd WiFi 1x2 BGN	N	N	GM45	Spanish (KB.I170A.050)	Continental
AS5738DZG-434G32Mn	EMEA	Eastern Europe	LX.PKF02.024	AS5738DZG-434G32Mn W7HP64ATEU5 MC M92XT512Cbb_2V3 2*2G/320/ 6L2.2/5R/ CB_bgn_0.3D_GC_GWW_HG_PL 71	PMDT4300	SO2GBI16	N320GB5.4KS	3rd WiFi 1x2 BGN	N	N	GM45	US International (KB.I170A.056)	Continental
AS5738DZG-434G32Mn	EMEA	Holland	LX.PKF02.021	AS5738DZG-434G32Mn W7HP64ATNL1 MC M92XT512Cbb_2V3 2*2G/320/ 6L2.2/5R/ CB_bgn_0.3D_GC_GWW_HG_NL 11	PMDT4300	SO2GBI16	N320GB5.4KS	3rd WiFi 1x2 BGN	N	N	GM45	US International (KB.I170A.056)	Continental
AS5738DZG-434G32Mn	EMEA	Eastern Europe	LX.PKF02.039	AS5738DZG-434G32Mn W7HP64ATEU5 MC M92XT512Cbb_2V3 2*2G/320/ 6L2.2/5R/ CB_bgn_0.3D_GC_GWW_HG_R O11	PMDT4300	SO2GBI16	N320GB5.4KS	3rd WiFi 1x2 BGN	N	N	GM45	US International (KB.I170A.056)	Continental
AS5738DZG-434G32Mn	EMEA	Poland	LX.PKF02.040	AS5738DZG-434G32Mn W7HP64ATPL1 MC M92XT512Cbb_2V3 2*2G/320/ 6L2.2/5R/ CB_bgn_0.3D_GC_GWW_HG_PL 11	PMDT4300	SO2GBI16	N320GB5.4KS	3rd WiFi 1x2 BGN	N	N	GM45	US International (KB.I170A.056)	Continental
AS5738DZG-434G32Mn	EMEA	Middle East	LX.PKF02.004	AS5738DZG-434G32Mn EM W7HP64EMATME4 MC M92XT512Cbb_2V3 2*2G/320/ 6L2.2/5R/ CB_bgn_0.3D_GC_GWW_HG_R U61	PMDT4300	SO2GBI16	N320GB5.4KS	3rd WiFi 1x2 BGN	N	N	GM45	Russian (KB.I170A.048)	Continental
AS5738DZG-434G32Mn	EMEA	Middle East	LX.PKF02.012	AS5738DZG-434G32Mn EM W7HP64EMATME4 MC M92XT512Cbb_2V3 2*2G/320/ 6L2.2/5R/ CB_bgn_0.3D_GC_GWW_HG_ES 61	PMDT4300	SO2GBI16	N320GB5.4KS	3rd WiFi 1x2 BGN	N	N	GM45	Russian (KB.I170A.048)	Continental
AS5738DZG-434G32Mi	EMEA	Russia	LX.PKF02.001	AS5738DZG-434G32Mi W7HP64RUATRU1 MC M92XT512Cbb_2V3 2*2G/320/ 6L2.2/5R/ CB_bgn_0.3D_GC_GWW_HG_RU 11	PMDT4300	SO2GBI16	N320GB5.4KS	3rd WiFi BG	N	N	GM45	Russian (KB.I170A.048)	Continental

Model	RO	Country	Acer Part No	Description	CPU	Memory 1/ Memory 2	HDD 1(GB)	Wireless LAN1	Bluetooth	Finger Print	NB Chipset	K/B	Power Cord
AS5738DZG-434G32Mn	EMEA	Sweden	LX.PKF02.017	AS5738DZG-434G32Mn W7HP64ATSE1 MC M92XT512Cbb_2V3 2*2G/320/ 6L2.2/5R/ CB_bgn_0.3D_GC_GWW_HG_FI 11	PMDT4300	SO2GBI16	N320GB5.4KS	3rd WiFi 1x2 BGN	N	N	GM45	Sweden (KB.I170A.051)	Continental
AS5738DZG-434G32Mn	EMEA	Finland	LX.PKF02.025	AS5738DZG-434G32Mn W7HP64ATF12 MC M92XT512Cbb_2V3 2*2G/320/ 6L2.2/5R/ CB_bgn_0.3D_GC_GWW_HG_FI 11	PMDT4300	SO2GBI16	N320GB5.4KS	3rd WiFi 1x2 BGN	N	N	GM45	Sweden (KB.I170A.051)	Continental
AS5738DZG-434G32Mn	EMEA	Portugal	LX.PKF02.035	AS5738DZG-434G32Mn W7HP64ATPT1 MC M92XT512Cbb_2V3 2*2G/320/ 6L2.2/5R/ CB_bgn_0.3D_GC_GWW_HG_PT 11	PMDT4300	SO2GBI16	N320GB5.4KS	3rd WiFi 1x2 BGN	N	N	GM45	Portuguese (KB.I170A.047)	Continental
AS5738DZG-434G32Mn	EMEA	Italy	LX.PKF02.023	AS5738DZG-434G32Mn W7HP64ATIT1 MC M92XT512Cbb_2V3 2*2G/320/ 6L2.2/5R/ CB_bgn_0.3D_GC_GWW_HG_IT 11	PMDT4300	SO2GBI16	N320GB5.4KS	3rd WiFi 1x2 BGN	N	N	GM45	Italian (KB.I170A.043)	Italian
AS5738DZG-434G32Mn	EMEA	Luxembourg	LX.PKF02.019	AS5738DZG-434G32Mn W7HP64ATLU3 MC M92XT512Cbb_2V3 2*2G/320/ 6L2.2/5R/ CB_bgn_0.3D_GC_GWW_HG_IT 41	PMDT4300	SO2GBI16	N320GB5.4KS	3rd WiFi 1x2 BGN	N	N	GM45	Swiss/G (KB.I170A.052)	Continental
AS5738DZG-434G32Mn	EMEA	Turkey	LX.PKF02.009	AS5738DZG-434G32Mn EM W7HP64EMATTR1 MC M92XT512Cbb_2V3 2*2G/320/ 6L2.2/5R/ CB_bgn_0.3D_GC_GWW_HG_TR 31	PMDT4300	SO2GBI16	N320GB5.4KS	3rd WiFi 1x2 BGN	N	N	GM45	Turkish (KB.I170A.054)	Continental
AS5738DZG-434G32Mn	EMEA	UK	LX.PKF02.031	AS5738DZG-434G32Mn W7HP64ATGB1 MC M92XT512Cbb_2V3 2*2G/320/ 6L2.2/5R/ CB_bgn_0.3D_GC_GWW_HG_E N11	PMDT4300	SO2GBI16	N320GB5.4KS	3rd WiFi 1x2 BGN	N	N	GM45	UK (KB.I170A.055)	UK
AS5738DZG-434G32Mn	EMEA	Eastern Europe	LX.PKF02.018	AS5738DZG-434G32Mn W7HP64ATEU7 MC M92XT512Cbb_2V3 2*2G/320/ 6L2.2/5R/ CB_bgn_0.3D_GC_GWW_HG_E NQ1	PMDT4300	SO2GBI16	N320GB5.4KS	3rd WiFi 1x2 BGN	N	N	GM45	SLO/CRO (KB.I170A.049)	Continental
AS5738DZG-434G32Mn	EMEA	Austria	LX.PKF02.030	AS5738DZG-434G32Mn W7HP64ATAT1 MC M92XT512Cbb_2V3 2*2G/320/ 6L2.2/5R/ CB_bgn_0.3D_GC_GWW_HG_D E61	PMDT4300	SO2GBI16	N320GB5.4KS	3rd WiFi 1x2 BGN	N	N	GM45	German (KB.I170A.040)	Continental
AS5738DZG-434G32Mn	EMEA	Germany	LX.PKF02.034	AS5738DZG-434G32Mn W7HP64ATDE1 MC M92XT512Cbb_2V3 2*2G/320/ 6L2.2/5R/ CB_bgn_0.3D_GC_GWW_HG_D E11	PMDT4300	SO2GBI16	N320GB5.4KS	3rd WiFi 1x2 BGN	N	N	GM45	German (KB.I170A.040)	Continental

Model	RO	Country	Acer Part No	Description	CPU	Memory 1/ Memory 2	HDD 1(GB)	Wireless LAN1	Bluetooth	Finger Print	NB Chipset	K/B	Power Cord
AS5738DZG-434G32Mn	EMEA	Czech	LX.PKF02.026	AS5738DZG-434G32Mn W7HP64ATCZ2 MC M92XT512Cbb_2V3 2*2G/320/ 6L2.2/5R/ CB_bgn_0.3D_GC_GWW_HG_SK 11	PMDT4300	SO2GBI16	N320GB5.4KS	3rd WiFi 1x2 BGN	N	N	GM45	CZ/SK (KB.I170A.035)	Continental
AS5738DZG-434G32Mn	EMEA	Middle East	LX.PKF02.006	AS5738DZG-434G32Mn EM W7HP64EMATME2 MC M92XT512Cbb_2V3 2*2G/320/ 6L2.2/5R/ CB_bgn_0.3D_GC_GWW_HG_ES 61	PMDT4300	SO2GBI16	N320GB5.4KS	3rd WiFi 1x2 BGN	N	N	GM45	Arabic (KB.I170A.032)	UK and US-110V
AS5738DZG-434G32Mn	EMEA	Middle East	LX.PKF02.008	AS5738DZG-434G32Mn EM W7HP64EMATME2 MC M92XT512Cbb_2V3 2*2G/320/ 6L2.2/5R/ CB_bgn_0.3D_GC_GWW_HG_A R21	PMDT4300	SO2GBI16	N320GB5.4KS	3rd WiFi 1x2 BGN	N	N	GM45	Arabic (KB.I170A.032)	UK and US-110V
AS5738DZG-434G32Mn	EMEA	Middle East	LX.PKF02.014	AS5738DZG-434G32Mn EM W7HP64EMATME2 MC M92XT512Cbb_2V3 2*2G/320/ 6L2.2/5R/ CB_bgn_0.3D_GC_GWW_HG_A R11	PMDT4300	SO2GBI16	N320GB5.4KS	3rd WiFi 1x2 BGN	N	N	GM45	Arabic (KB.I170A.032)	UK and US-110V
AS5738DZG-434G32Mn	EMEA	Algeria	LX.PKF02.003	AS5738DZG-434G32Mn EM W7HP64EMATDZ1 MC M92XT512Cbb_2V3 2*2G/320/ 6L2.2/5R/ CB_bgn_0.3D_GC_GWW_HG_ES 81	PMDT4300	SO2GBI16	N320GB5.4KS	3rd WiFi 1x2 BGN	N	N	GM45	FR/Arabic (KB.I170A.038)	Continental
AS5738DZG-434G32Mn	EMEA	Middle East	LX.PKF02.015	AS5738DZG-434G32Mn EM W7HP64EMATME9 MC M92XT512Cbb_2V3 2*2G/320/ 6L2.2/5R/ CB_bgn_0.3D_GC_GWW_HG_ES 81	PMDT4300	SO2GBI16	N320GB5.4KS	3rd WiFi 1x2 BGN	N	N	GM45	FR/Arabic (KB.I170A.038)	Continental
AS5738DZG-434G32Mn	EMEA	Middle East	LX.PKF02.013	AS5738DZG-434G32Mn EM W7HP64EMATME6 MC M92XT512Cbb_2V3 2*2G/320/ 6L2.2/5R/ CB_bgn_0.3D_GC_GWW_HG_ES 61	PMDT4300	SO2GBI16	N320GB5.4KS	3rd WiFi 1x2 BGN	N	N	GM45	US International (KB.I170A.056)	UK
AS5738DZG-434G32Mn	EMEA	South Africa	LX.PKF02.011	AS5738DZG-434G32Mn EM W7HP64EMATZ2 MC M92XT512Cbb_2V3 2*2G/320/ 6L2.2/5R/ CB_bgn_0.3D_GC_GWW_HG_ES 61	PMDT4300	SO2GBI16	N320GB5.4KS	3rd WiFi 1x2 BGN	N	N	GM45	US International (KB.I170A.056)	AF
AS5738DZG-434G32Mn	EMEA	South Africa	LX.PKF02.005	AS5738DZG-434G32Mn EM W7HP64EMATZ4 MC M92XT512Cbb_2V3 2*2G/320/ 6L2.2/5R/ CB_bgn_0.3D_GC_GWW_HG_ES 61	PMDT4300	SO2GBI16	N320GB5.4KS	3rd WiFi 1x2 BGN	N	N	GM45	US International (KB.I170A.056)	UK
AS5738DZG-434G32Mn	EMEA	Denmark	LX.PKF02.038	AS5738DZG-434G32Mn W7HP64ATDK1 MC M92XT512Cbb_2V3 2*2G/320/ 6L2.2/5R/ CB_bgn_0.3D_GC_GWW_HG_N O11	PMDT4300	SO2GBI16	N320GB5.4KS	3rd WiFi 1x2 BGN	N	N	GM45	Danish (KB.I170A.037)	Danish

Model	RO	Country	Acer Part No	Description	CPU	Memory 1/ Memory 2	HDD 1(GB)	Wireless LAN1	Bluetooth	Finger Print	NB Chipset	K/B	Power Cord
AS5738DZG-434G32Mn	EMEA	Hungary	LX.PKF02.037	AS5738DZG-434G32Mn W7HP64ATHU1 MC M92XT512Cbb_2V3 2*2G/320/ 6L2.2/5R/ CB_bgn_0.3D_GC_GWW_HG_H U11	PMDT4300	SO2GBI16	N320GB5.4KS	3rd WiFi 1x2 BGN	N	N	GM45	Hungarian (KB.I170A.042)	Continental
AS5738DZG-434G32Mn	EMEA	Greece	LX.PKF02.042	AS5738DZG-434G32Mn W7HP64ATGR1 MC M92XT512Cbb_2V3 2*2G/320/ 6L2.2/5R/ CB_bgn_0.3D_GC_GWW_HG_EL 31	PMDT4300	SO2GBI16	N320GB5.4KS	3rd WiFi 1x2 BGN	N	N	GM45	Greek (KB.I170A.041)	Continental
AS5738DZG-434G32Mn	EMEA	France	LX.PKF02.032	AS5738DZG-434G32Mn W7HP64ATFR1 MC M92XT512Cbb_2V3 2*2G/320/ 6L2.2/5R/ CB_bgn_0.3D_GC_GWW_HG_FR 21	PMDT4300	SO2GBI16	N320GB5.4KS	3rd WiFi 1x2 BGN	N	N	GM45	French (KB.I170A.039)	Continental
AS5738DZG-434G32Mn	EMEA	Middle East	LX.PKF02.010	AS5738DZG-434G32Mn EM W7HP64EMATME3 MC M92XT512Cbb_2V3 2*2G/320/ 6L2.2/5R/ CB_bgn_0.3D_GC_GWW_HG_ES 81	PMDT4300	SO2GBI16	N320GB5.4KS	3rd WiFi 1x2 BGN	N	N	GM45	French (KB.I170A.039)	Continental
AS5738DZG-434G32Mn	EMEA	South Africa	LX.PKF02.007	AS5738DZG-434G32Mn EM W7HP64EMATZA1 MC M92XT512Cbb_2V3 2*2G/320/ 6L2.2/5R/ CB_bgn_0.3D_GC_GWW_HG_ES 81	PMDT4300	SO2GBI16	N320GB5.4KS	3rd WiFi 1x2 BGN	N	N	GM45	French (KB.I170A.039)	Continental
AS5738DZG-434G32Mn	EMEA	Cyprus	LX.PKF02.020	AS5738DZG-434G32Mn W7HP64ATCY1 MC M92XT512Cbb_2V3 2*2G/320/ 6L2.2/5R/ CB_bgn_0.3D_GC_GWW_HG_ES 61	PMDT4300	SO2GBI16	N320GB5.4KS	3rd WiFi 1x2 BGN	N	N	GM45	UK (KB.I170A.055)	UK
AS5738DZG-434G32Mn	EMEA	Norway	LX.PKF02.028	AS5738DZG-434G32Mn W7HP64ATNO1 MC M92XT512Cbb_2V3 2*2G/320/ 6L2.2/5R/ CB_bgn_0.3D_GC_GWW_HG_N O11	PMDT4300	SO2GBI16	N320GB5.4KS	3rd WiFi 1x2 BGN	N	N	GM45	Norwegian (KB.I170A.046)	Continental
AS5738DZG-434G32Mn	EMEA	Eastern Europe	LX.PKF02.029	AS5738DZG-434G32Mn W7HP64ATEU4 MC M92XT512Cbb_2V3 2*2G/320/ 6L2.2/5R/ CB_bgn_0.3D_GC_GWW_HG_SV 21	PMDT4300	SO2GBI16	N320GB5.4KS	3rd WiFi 1x2 BGN	N	N	GM45	Sweden (KB.I170A.051)	Continental
AS5738DZG-434G32Mn	EMEA	Norway	LX.PKF02.033	AS5738DZG-434G32Mn W7HP64ATNO3 MC M92XT512Cbb_2V3 2*2G/320/ 6L2.2/5R/ CB_bgn_0.3D_GC_GWW_HG_E NS1	PMDT4300	SO2GBI16	N320GB5.4KS	3rd WiFi 1x2 BGN	N	N	GM45	Nordic (KB.I170A.045)	Danish/Continental
AS5738DZG-434G32Mn	EMEA	Belgium	LX.PKF02.041	AS5738DZG-434G32Mn W7HP64ATBE1 MC M92XT512Cbb_2V3 2*2G/320/ 6L2.2/5R/ CB_bgn_0.3D_GC_GWW_HG_NL 11	PMDT4300	SO2GBI16	N320GB5.4KS	3rd WiFi 1x2 BGN	N	N	GM45	Belgium (KB.I170A.033)	Continental

Model	RO	Country	Acer Part No	Description	CPU	Memory 1/ Memory 2	HDD 1(GB)	Wireless LAN1	Bluetooth	Finger Print	NB Chipset	K/B	Power Cord
AS5738DZG-433G32Mn	EMEA	Israel	LX.PKF02.055	AS5738DZG-433G32Mn W7HP64ATIL1 MC M92XT512Cbb_2V3 2G+1G/320/ 6L2.2/5R/ CB_bgn_0.3D_GC_GWW_HG_H E11	PMDT4300	SO2GBI16	N320GB5.4KS	3rd WiFi 1x2 BGN	N	N	GM45	US International w/ Hebrew (KB.I170A.057)	Israel
AS5738DZG-433G32Mn	EMEA	Cyprus	LX.PKF02.053	AS5738DZG-433G32Mn W7HP64ATCY1 MC M92XT512Cbb_2V3 2G+1G/320/ 6L2.2/5R/ CB_bgn_0.3D_GC_GWW_HG_ES 61	PMDT4300	SO2GBI16	N320GB5.4KS	3rd WiFi 1x2 BGN	N	N	GM45	UK (KB.I170A.055)	UK
AS5738DZG-433G32Mn	EMEA	Latvia	LX.PKF02.051	AS5738DZG-433G32Mn W7HP64ATLV1 MC M92XT512Cbb_2V3 2G+1G/320/ BT/6L2.2/5R/ CB_bgn_0.3D_GC_GWW_HG_R U22	PMDT4300	SO2GBI16	N320GB5.4KS	3rd WiFi 1x2 BGN	BT 2.1	N	GM45	Russian (KB.I170A.048)	Continental
AS5738DZG-432G32Mn	CHINA	Hong Kong	LX.PKF02.050	AS5738DZG-432G32Mn W7HP64ATHK2 MC M92XT512Cbb_2V3 1*2G/320/BT/ 6L2.2/5R/ CB_bgn_0.3D_GC_GWE_HG_ZH 34	PMDT4300	SO2GBI16/N	N320GB5.4KS	3rd WiFi 1x2 BGN	BT 2.1	N	GM45	US International (KB.I170A.056)	UK
AS5738DZG-433G32Mi	EMEA	Russia	LX.PKF02.049	AS5738DZG-433G32Mi W7HP64RUATRU1 MC M92XT512Cbb_2V3 2G+1G/320/ BT/6L2.2/5R/ CB_bg_0.3D_GC_GWW_HG_RU 11	PMDT4300	SO2GBI16	N320GB5.4KS	3rd WiFi BG	BT 2.1	N	GM45	Russian (KB.I170A.048)	Continental
AS5738DZG-433G32Mn	EMEA	Eastern Europe	LX.PKF02.048	AS5738DZG-433G32Mn W7HP64ATEU5 MC M92XT512Cbb_2V3 2G+1G/320/ BT/6L2.2/5R/ CB_bgn_0.3D_GC_GWW_HG_R O11	PMDT4300	SO2GBI16	N320GB5.4KS	3rd WiFi 1x2 BGN	BT 2.1	N	GM45	US International (KB.I170A.056)	Continental
AS5738DZG-432G32Mn	CHINA	China	LX.PKF01.001	AS5738DZG-432G32Mn W7HB64SCATCN1 MC M92XT512Cbb_2V3 1*2G/320/BT/ 6L2.2/5R/ CB_bgn_0.3D_GC_GWE_HG_SC 13	PMDT4300	SO2GBI16/N	N320GB5.4KS	3rd WiFi 1x2 BGN	BT 2.1	N	GM45	US International (KB.I170A.056)	PRC
AS5738DZG-434G32Mn	EMEA	Spain	LX.PKF02.046	AS5738DZG-434G32Mn W7HP64ATES1 MC M92XT512Cbb_2V3 2*2G/320/ 6L2.2/5R/ CB_bgn_0.3D_GC_GWW_HG_ES 51	PMDT4300	SO2GBI16	N320GB5.4KS	3rd WiFi 1x2 BGN	N	N	GM45	Spanish (KB.I170A.050)	Continental

# Aspire 5542G/5542/5242 Series

**NOTE:** All models have following common specifications: Card reader (5-in-1), LCD (NLED15.6WXGAG), NB Chipset (AMDRS880M), SB (AMDSB710), Battery (6CELL2.2)

Model	RO	Country	Acer Part No	Description	CPU	LCD	VGA Chip	VRAM 1	Memory 1/ Memory 2	HDD 1(GB)	ODD	Wireless LAN1	Bluetooth	Finger Print	Adapter	Camera	K/B	Power Cord
AS5242-102G25Mn	WW	GCTWN	S2.PHTOC.001	AS5242-102G25Mn LINPUSAWW1 UMACFbb 2*1G/250/BT/6L2.2/5R/ CB_bgn_FP_0.3D_HG_ENX1	SMPM100	NLED15.6WXGAG	UMA	N	SO1GBII6	N250GB5.4KS	NSM8XS	3rd WiFi 1x2 BGN	BT 2.1	AES1610	65W	0.3M DV	US International (KB.I170A.056)	US and Continental
AS5242-102G25Mn	WW	GCTWN	S2.PHS0C.001	AS5242-102G25Mn LINPUSAWW1 UMACbb 2*1G/250/BT/6L2.2/5R/ CB_bgn_0.3D_HG_ENX1	SMPM100	NLED15.6WXGAG	UMA	N	SO1GBII6	N250GB5.4KS	NSM8XS	3rd WiFi 1x2 BGN	BT 2.1	N	65W	0.3M DV	US International (KB.I170A.056)	US and Continental
AS5242-102G25Mn	WW	GCTWN	S2.PHR0C.001	AS5242-102G25Mn LINPUSAWW1 UMAbb 2*1G/250/BT/6L2.2/5R/ CB_bgn_HG_ENX1	SMPM100	NLED15.6WXGAG	UMA	N	SO1GBII6	N250GB5.4KS	NSM8XS	3rd WiFi 1x2 BGN	BT 2.1	N	65W	N	US International (KB.I170A.056)	US and Continental
AS5542G-503G32Mn	AAP	India	LX.PHQ0C.009	AS5542G-503G32Mn LINPUSAIN1 M92XT512CFbb_V3 2G+1G/320/BT/ 6L2.2/5R/CB_bgn_FP_0.3D_HG_EN11	ATM500	NLED15.6WXGAG	M92XT	512M- DDR3 (64*16*4)	SO2GBII6	N320GB5.4KS	NSM8XS	3rd WiFi 1x2 BGN	BT 2.1	AES1610	90W	0.3M DV	US International (KB.I170A.056)	SouthAfrica-S (India)
AS5542G-504G50Mn	AAP	India	LX.PHQ02.005	AS5542G-504G50Mn W7HP64NATIN1 MC M92XT512CFbb_V3 2*2G/500_L/BT/ 6L2.2/5R/CB_bgn_FP_0.3D_HG_ES61	ATM500	NLED15.6WXGAG	M92XT	512M- DDR3 (64*16*4)	SO2GBII6	N500GB5.4KS	NSM8XS	3rd WiFi 1x2 BGN	BT 2.1	AES1610	90W	0.3M DV	US International (KB.I170A.056)	SouthAfrica-S (India)
AS5542G-503G32Mn	AAP	India	LX.PHQ02.011	AS5542G-503G32Mn W7HP64NATIN1 MC M92XT512CFbb_V3 2G+1G/320/BT/ 6L2.2/5R/CB_bgn_FP_0.3D_HG_ES61	ATM500	NLED15.6WXGAG	M92XT	512M- DDR3 (64*16*4)	SO2GBII6	N320GB5.4KS	NSM8XS	3rd WiFi 1x2 BGN	BT 2.1	AES1610	90W	0.3M DV	US International (KB.I170A.056)	SouthAfrica-S (India)
AS5542G-304G50Mn	AAP	Australia/ New Zealand	LX.PHQ02.010	AS5542G-304G50Mn W7HP64ATAU1 MC M92XT512CFbb_V3 2*2G/500_L/ 6L2.2/5R/CB_bgn_FP_0.3D_HG_ES61	AAM300	NLED15.6WXGAG	M92XT	512M- DDR3 (64*16*4)	SO2GBII6	N500GB5.4KS	NSM8XS	3rd WiFi 1x2 BGN	N	AES1610	90W	0.3M DV	US International (KB.I170A.056)	Australia w/ label
AS5542G-304G50Mn	AAP	Australia/ New Zealand	LX.PHQ02.009	AS5542G-304G50Mn W7HP64ATAU1 MC M92XT512CFbb_V3 2*2G/500_L/BT/ 6L2.2/5R/CB_bgn_FP_0.3D_HG_ES61	AAM300	NLED15.6WXGAG	M92XT	512M- DDR3 (64*16*4)	SO2GBII6	N500GB5.4KS	NSM8XS	3rd WiFi 1x2 BGN	BT 2.1	AES1610	90W	0.3M DV	US International (KB.I170A.056)	Australia w/ label
AS5542G-604G50Mn	AAP	Singapore	LX.PHQ02.008	AS5542G-604G50Mn W7HP64ATSG1 MC M92XT512CFbb_V3 2*2G/500_L/BT/ 6L2.2/5R/CB_bgn_FP_0.3D_HG_ES61	ATUM600	NLED15.6WXGAG	M92XT	512M- DDR3 (64*16*4)	SO2GBII6	N500GB5.4KS	NSM8XS	3rd WiFi 1x2 BGN	BT 2.1	AES1610	90W	0.3M DV	US International (KB.I170A.056)	UK
AS5542G-644G50Mn	AAP	Singapore	LX.PHQ02.007	AS5542G-644G50Mn W7HP64ATSG1 MC M92XT512CFbb_V3 2*2G/500_L/BT/ 6L2.2/5R/CB_bgn_FP_0.3D_HG_ES61	ATUM640	NLED15.6WXGAG	M92XT	512M- DDR3 (64*16*4)	SO2GBII6	N500GB5.4KS	NSM8XS	3rd WiFi 1x2 BGN	BT 2.1	AES1610	90W	0.3M DV	US International (KB.I170A.056)	UK
AS5542G-624G50Mn	AAP	Singapore	LX.PHQ02.006	AS5542G-624G50Mn W7HP64ATSG1 MC M92XT512CFbb_V3 2*2G/500_L/BT/ 6L2.2/5R/CB_bgn_FP_0.3D_HG_ES61	ATUM620	NLED15.6WXGAG	M92XT	512M- DDR3 (64*16*4)	SO2GBII6	N500GB5.4KS	NSM8XS	3rd WiFi 1x2 BGN	BT 2.1	AES1610	90W	0.3M DV	US International (KB.I170A.056)	UK
AS5542G-644G50Mn	AAP	Thailand	LX.PHQ0C.008	AS5542G-644G50Mn LINPUSATH1 M92XT512CFbb_V3 2*2G/500_L/BT/ 6L2.2/5R/CB_bgn_FP_0.3D_HG_TH51	ATUM640	NLED15.6WXGAG	M92XT	512M- DDR3 (64*16*4)	SO2GBII6	N500GB5.4KS	NSM8XS	3rd WiFi 1x2 BGN	BT 2.1	AES1610	90W	0.3M DV	Thailand (KB.I170A.053)	US-110V
AS5542G-642G50Mn	AAP	Thailand	LX.PHQ0C.007	AS5542G-642G50Mn LINPUSATH1 M92XT512CFbb_V3 1*2G/500_L/BT/ 6L2.2/5R/CB_bgn_FP_0.3D_HG_TH51	ATUM640	NLED15.6WXGAG	M92XT	512M- DDR3 (64*16*4)	SO2GBII6/N	N500GB5.4KS	NSM8XS	3rd WiFi 1x2 BGN	BT 2.1	AES1610	90W	0.3M DV	Thailand (KB.I170A.053)	US-110V
AS5542G-622G50Mn	AAP	Thailand	LX.PHQ0C.006	AS5542G-622G50Mn LINPUSATH1 M92XT512CFbb_V3 1*2G/500_L/BT/ 6L2.2/5R/CB_bgn_FP_0.3D_HG_TH51	ATUM620	NLED15.6WXGAG	M92XT	512M- DDR3 (64*16*4)	SO2GBII6/N	N500GB5.4KS	NSM8XS	3rd WiFi 1x2 BGN	BT 2.1	AES1610	90W	0.3M DV	Thailand (KB.I170A.053)	US-110V
AS5542G-624G50Mn	AAP	Thailand	LX.PHQ0C.005	AS5542G-624G50Mn LINPUSATH1 M92XT512CFbb_V3 2*2G/500_L/BT/ 6L2.2/5R/CB_bgn_FP_0.3D_HG_TH51	ATUM620	NLED15.6WXGAG	M92XT	512M- DDR3 (64*16*4)	SO2GBII6	N500GB5.4KS	NSM8XS	3rd WiFi 1x2 BGN	BT 2.1	AES1610	90W	0.3M DV	Thailand (KB.I170A.053)	US-110V
AS5542G-604G50Mn	AAP	Thailand	LX.PHQ0C.004	AS5542G-604G50Mn LINPUSATH1 M92XT512CFbb_V3 2*2G/500_L/BT/ 6L2.2/5R/CB_bgn_FP_0.3D_HG_TH51	ATUM600	NLED15.6WXGAG	M92XT	512M- DDR3 (64*16*4)	SO2GBII6	N500GB5.4KS	NSM8XS	3rd WiFi 1x2 BGN	BT 2.1	AES1610	90W	0.3M DV	Thailand (KB.I170A.053)	US-110V
AS5542G-602G50Mn	AAP	Thailand	LX.PHQ0C.003	AS5542G-602G50Mn LINPUSATH1 M92XT512CFbb_V3 1*2G/500_L/BT/ 6L2.2/5R/CB_bgn_FP_0.3D_HG_TH51	ATUM600	NLED15.6WXGAG	M92XT	512M- DDR3 (64*16*4)	SO2GBII6	N500GB5.4KS	NSM8XS	3rd WiFi 1x2 BGN	BT 2.1	AES1610	90W	0.3M DV	Thailand (KB.I170A.053)	US-110V

Model	RO	Country	Acer Part No	Description	CPU	LCD	VGA Chip	VRAM 1	Memory 1/ Memory 2	HDD 1 (GB)	ODD	Wireless LAN1	Bluetooth	Finger Print	Adapter	Camera	K/B	Power Cord
AS5542G-504G50Mn	AAP	India	LX.PHQ0C.002	AS5542G-504G50Mn LINPUSA1N1 M92XT512CFbb_V3 2*2G/500_L/BT/6L2.2/5R/CB_bgn_FP_0.3D_HG_EN11	ATM500	NLED15.6WXGAG	M92XT	512M-DDR3 (64*16*4)	SO2GBII6	N500GB5.4KS	NSM8XS	3rd WiFi 1x2 BGN	BT 2.1	AES1610	90W	0.3M DV	US International (KB.I170A.056)	South Africa-S (India)
AS5542G-504G32Mn	AAP	India	LX.PHQ0C.001	AS5542G-504G32Mn LINPUSA1N1 M92XT512CFbb_V3 2*2G/320/BT/6L2.2/5R/CB_bgn_FP_0.3D_HG_EN11	ATM500	NLED15.6WXGAG	M92XT	512M-DDR3 (64*16*4)	SO2GBII6	N320GB5.4KS	NSM8XS	3rd WiFi 1x2 BGN	BT 2.1	AES1610	90W	0.3M DV	US International (KB.I170A.056)	South Africa-S (India)
AS5542G-504G32Mn	AAP	India	LX.PHQ02.004	AS5542G-504G32Mn W7HP64INATIN1 MC M92XT512CFbb_V3 2*2G/320/BT/6L2.2/5R/CB_bgn_FP_0.3D_HG_ES61	ATM500	NLED15.6WXGAG	M92XT	512M-DDR3 (64*16*4)	SO2GBII6	N320GB5.4KS	NSM8XS	3rd WiFi 1x2 BGN	BT 2.1	AES1610	90W	0.3M DV	US International (KB.I170A.056)	South Africa-S (India)
AS5542G-324G50Mn	AAP	Australia/ New Zealand	LX.PHQ02.003	AS5542G-324G50Mn W7HP64ATAU1 MC M92XT512CFbb_V3 2*2G/500_L/BT/6L2.2/5R/CB_bgn_FP_0.3D_HG_ES61	AAM320	NLED15.6WXGAG	M92XT	512M-DDR3 (64*16*4)	SO2GBII6	N500GB5.4KS	NSM8XS	3rd WiFi 1x2 BGN	BT 2.1	AES1610	90W	0.3M DV	US International (KB.I170A.056)	Australia w/ label
AS5542G-304G32Mn	AAP	Australia/ New Zealand	LX.PHQ02.002	AS5542G-304G32Mn W7HP64ATAU1 MC M92XT512CFbb_V3 2*2G/320/BT/6L2.2/5R/CB_bgn_FP_0.3D_HG_ES61	AAM300	NLED15.6WXGAG	M92XT	512M-DDR3 (64*16*4)	SO2GBII6	N320GB5.4KS	NSM8XS	3rd WiFi 1x2 BGN	BT 2.1	AES1610	90W	0.3M DV	US International (KB.I170A.056)	Australia w/ label
AS5542G-324G32Mn	AAP	Australia/ New Zealand	LX.PHQ02.001	AS5542G-324G32Mn W7HP64ATAU1 MC M92XT512CFbb_V3 2*2G/320/BT/6L2.2/5R/CB_bgn_FP_0.3D_HG_ES61	AAM320	NLED15.6WXGAG	M92XT	512M-DDR3 (64*16*4)	SO2GBII6	N320GB5.4KS	NSM8XS	3rd WiFi 1x2 BGN	BT 2.1	AES1610	90W	0.3M DV	US International (KB.I170A.056)	Australia w/ label
AS5542G-622G32Bn	WW	GCTWN	S2.PHQ0C.001	AS5542G-622G32Bn LINPUSAWW1 M92XT512CFbb_V3 2*2G/320/BT/6L2.2/5R/CB_bgn_FP_0.3D_HG_ENX1	ATUM620	NLED15.6WXGAG	M92XT	512M-DDR3 (64*16*4)	SO1GBII6	N320GB5.4KS	NBDCB4 XS	3rd WiFi 1x2 BGN	BT 2.1	AES1610	90W	0.3M DV	US International (KB.I170A.056)	US and Continental
AS5542G-302G32Mn	CHINA	China	LX.PHP0C.010	AS5542G-302G32Mn LINPUSACN1 M92XT512Cbb_V3 1*2G/320/6L2.2/5R/CB_bgn_0.3D_HG_EN91	AAM300	NLED15.6WXGAG	M92XT	512M-DDR3 (64*16*4)	SO2GBII6/N	N320GB5.4KS	NSM8XS	3rd WiFi 1x2 BGN	N	N	90W	0.3M DV	US International (KB.I170A.056)	PRC
AS5542G-502G32Mn	CHINA	China	LX.PHP0C.005	AS5542G-502G32Mn LINPUSACN1 M92XT512Cbb_V3 1*2G/320/BT/6L2.2/5R/CB_bgn_0.3D_HG_EN91	ATM500	NLED15.6WXGAG	M92XT	512M-DDR3 (64*16*4)	SO2GBII6/N	N320GB5.4KS	NSM8XS	3rd WiFi 1x2 BGN	BT 2.1	N	90W	0.3M DV	US International (KB.I170A.056)	PRC
AS5542G-304G50Mn	EMEA	Czech	LX.PHP02.059	AS5542G-304G50Mn W7HP64ATCZ2 MC M92XT512Cbb_V3 2*2G/500_L/BT/6L2.2/5R/CB_bgn_0.3D_HG_SK11	AAM300	NLED15.6WXGAG	M92XT	512M-DDR3 (64*16*4)	SO2GBII6	N500GB5.4KS	NSM8XS	3rd WiFi 1x2 BGN	BT 2.1	N	90W	0.3M DV	CZ/SK (KB.I170A.035)	Continental
AS5542G-303G25Mn	EMEA	Italy	LX.PHP02.062	AS5542G-303G25Mn W7HP64AT11 MC M92XT512Cbb_V3 2G+1G/250/6L2.2/5R/CB_bgn_0.3D_HG_IT11	AAM300	NLED15.6WXGAG	M92XT	512M-DDR3 (64*16*4)	SO2GBII6	N250GB5.4KS	NSM8XS	3rd WiFi 1x2 BGN	N	N	90W	0.3M DV	Italian (KB.I170A.043)	Italian
AS5542G-303G25MI	EMEA	Russia	LX.PHP01.001	AS5542G-303G25MI W7HB64RUATRU1 MC M92XT512Cbb_V3 2G+1G/250/6L2.2/5R/CB_bg_0.3D_HG_RU11	AAM300	NLED15.6WXGAG	M92XT	512M-DDR3 (64*16*4)	SO2GBII6	N250GB5.4KS	NSM8XS	3rd WiFi BG	N	N	90W	0.3M DV	Russian (KB.I170A.048)	Continental
AS5542G-304G32Mn	EMEA	Czech	LX.PHP02.072	AS5542G-304G32Mn W7HP64ATCZ2 MC M92XT512Cbb_V3 2*2G/320/BT/6L2.2/5R/CB_bgn_0.3D_HG_SK11	AAM300	NLED15.6WXGAG	M92XT	512M-DDR3 (64*16*4)	SO2GBII6	N320GB5.4KS	NSM8XS	3rd WiFi 1x2 BGN	BT 2.1	N	90W	0.3M DV	CZ/SK (KB.I170A.035)	Continental
AS5542G-304G50Mn	AAP	Australia/ New Zealand	LX.PHP02.066	AS5542G-304G50Mn W7HP64ATAU1 MC M92XT512Cbb_V3 2*2G/500_L/6L2.2/5R/CB_bgn_0.3D_HG_ES61	AAM300	NLED15.6WXGAG	M92XT	512M-DDR3 (64*16*4)	SO2GBII6	N500GB5.4KS	NSM8XS	3rd WiFi 1x2 BGN	N	N	90W	0.3M DV	US International (KB.I170A.056)	Australia w/ label
AS5542G-303G25Mn	EMEA	Poland	LX.PHP02.075	AS5542G-303G25Mn W7HP64ATPL1 MC M92XT512Cbb_V3 2G+1G/250/BT/6L2.2/5R/CB_bgn_0.3D_HG_PL11	AAM300	NLED15.6WXGAG	M92XT	512M-DDR3 (64*16*4)	SO2GBII6	N250GB5.4KS	NSM8XS	3rd WiFi 1x2 BGN	BT 2.1	N	90W	0.3M DV	US International (KB.I170A.056)	Continental
AS5542G-304G32MI	EMEA	Russia	LX.PHP02.118	AS5542G-304G32MI W7HP64RUATRU1 MC M92XT512Cbb_V3 2*2G/320/BT/6L2.2/5R/CB_bg_0.3D_HG_RU11	AAM300	NLED15.6WXGAG	M92XT	512M-DDR3 (64*16*4)	SO2GBII6	N320GB5.4KS	NSM8XS	3rd WiFi BG	BT 2.1	N	90W	0.3M DV	Russian (KB.I170A.048)	Continental
AS5542G-304G50Mn	EMEA	Spain	LX.PHP02.047	AS5542G-304G50Mn W7HP64ATES1 MC M92XT512Cbb_V3 2*2G/500_L/6L2.2/5R/CB_bgn_0.3D_HG_ES51	AAM300	NLED15.6WXGAG	M92XT	512M-DDR3 (64*16*4)	SO2GBII6	N500GB5.4KS	NSM8XS	3rd WiFi 1x2 BGN	N	N	90W	0.3M DV	Spanish (KB.I170A.050)	Continental
AS5542G-524G32Mn	EMEA	South Africa	LX.PHP02.051	AS5542G-524G32Mn EM W7HP64EMATZA2 MC M92XT512Cbb_V3 2*2G/320/BT/6L2.2/5R/CB_bgn_0.3D_HG_ES61	ATM520	NLED15.6WXGAG	M92XT	512M-DDR3 (64*16*4)	SO2GBII6	N320GB5.4KS	NSM8XS	3rd WiFi 1x2 BGN	BT 2.1	N	90W	0.3M DV	US International (KB.I170A.056)	AF
AS5542G-303G25Mn	EMEA	Turkey	LX.PHP01.003	AS5542G-303G25Mn EM W7HB64EMATTR1 MC M92XT512Cbb_V3 2G+1G/250/6L2.2/5R/CB_bgn_0.3D_HG_TR31	AAM300	NLED15.6WXGAG	M92XT	512M-DDR3 (64*16*4)	SO2GBII6	N250GB5.4KS	NSM8XS	3rd WiFi 1x2 BGN	N	N	90W	0.3M DV	Turkish (KB.I170A.054)	Continental



Model	RO	Country	Acer Part No	Description	CPU	LCD	VGA Chip	VRAM 1	Memory 1/ Memory 2	HDD 1 (GB)	ODD	Wireless LAN1	Bluetooth	Finger Print	Adapter	Camera	K/B	Power Cord
AS5542G-304G32Mn	EMEA	Hungary	LX.PHP0C.011	AS5542G-304G32Mn LINPUSAHU1 M92XT512Cbb_V3 2*2G/320/6L2.2/5R/CB_bgn_0.3D_HG_EN41	AAM300	NLED15.6WXGAG	M92XT	512M-DDR3 (64*16*4)	SO2GBII6	N320GB5.4KS	NSM8XS	3rd WiFi 1x2 BGN	N	N	90W	0.3M DV	Hungarian (KB.1170A.042)	Continental
AS5542G-304G50Mn	EMEA	France	LX.PHP02.116	AS5542G-304G50Mn W7HP64ATFR1 MC M92XT512Cbb_V3 2*2G/500_L/6L2.2/5R/CB_bgn_0.3D_HG_FR21	AAM300	NLED15.6WXGAG	M92XT	512M-DDR3 (64*16*4)	SO2GBII6	N500GB5.4KS	NSM8XS	3rd WiFi 1x2 BGN	N	N	90W	0.3M DV	French (KB.1170A.039)	Continental
AS5542G-524G32Mn	EMEA	Germany	LX.PHP02.049	AS5542G-524G32Mn W7HP64ATDE1 MC M92XT512Cbb_V3 2*2G/320/6L2.2/5R/CB_bgn_0.3D_HG_DE11	ATM520	NLED15.6WXGAG	M92XT	512M-DDR3 (64*16*4)	SO2GBII6	N320GB5.4KS	NSM8XS	3rd WiFi 1x2 BGN	N	N	90W	0.3M DV	German (KB.1170A.040)	Continental
AS5542G-504G32Mn	EMEA	Spain	LX.PHP02.070	AS5542G-504G32Mn W7HP64ATES1 MC M92XT512Cbb_V3 2*2G/320/6L2.2/5R/CB_bgn_0.3D_HG_ES51	ATM500	NLED15.6WXGAG	M92XT	512M-DDR3 (64*16*4)	SO2GBII6	N320GB5.4KS	NSM8XS	3rd WiFi 1x2 BGN	N	N	90W	0.3M DV	Spanish (KB.1170A.050)	Continental
AS5542G-304G50Mn	EMEA	Denmark	LX.PHP02.055	AS5542G-304G50Mn W7HP64ATDK2 MC M92XT512Cbb_V3 2*2G/500_L/6L2.2/5R/CB_bgn_0.3D_HG_ENS1	AAM300	NLED15.6WXGAG	M92XT	512M-DDR3 (64*16*4)	SO2GBII6	N500GB5.4KS	NSM8XS	3rd WiFi 1x2 BGN	N	N	90W	0.3M DV	Nordic (KB.1170A.045)	Danish/ Continental
AS5542G-504G32Mi	EMEA	Russia	LX.PHP02.052	AS5542G-504G32Mi W7HP64RUATRU1 MC M92XT512Cbb_V3 2*2G/320/6L2.2/5R/CB_bgn_0.3D_HG_RU11	ATM500	NLED15.6WXGAG	M92XT	512M-DDR3 (64*16*4)	SO2GBII6	N320GB5.4KS	NSM8XS	3rd WiFi BG	N	N	90W	0.3M DV	Russian (KB.1170A.048)	Continental
AS5542G-304G32Mn	EMEA	Poland	LX.PHP02.020	AS5542G-304G32Mn W7HP64ATPL1 MC M92XT512Cbb_V3 2*2G/320/6L2.2/5R/CB_bgn_0.3D_HG_PL11	AAM300	NLED15.6WXGAG	M92XT	512M-DDR3 (64*16*4)	SO2GBII6	N320GB5.4KS	NSM8XS	3rd WiFi 1x2 BGN	N	N	90W	0.3M DV	US International (KB.1170A.056)	Continental
AS5542G-304G32Mn	EMEA	Hungary	LX.PHP02.039	AS5542G-304G32Mn W7HP64ATHU1 MC M92XT512Cbb_V3 2*2G/320/6L2.2/5R/CB_bgn_0.3D_HG_HU11	AAM300	NLED15.6WXGAG	M92XT	512M-DDR3 (64*16*4)	SO2GBII6	N320GB5.4KS	NSM8XS	3rd WiFi 1x2 BGN	N	N	90W	0.3M DV	Hungarian (KB.1170A.042)	Continental
AS5542G-504G32Mn	EMEA	Denmark	LX.PHP02.071	AS5542G-504G32Mn W7HP64ATDK2 MC M92XT512Cbb_V3 2*2G/320/6L2.2/5R/CB_bgn_0.3D_HG_ENS1	ATM500	NLED15.6WXGAG	M92XT	512M-DDR3 (64*16*4)	SO2GBII6	N320GB5.4KS	NSM8XS	3rd WiFi 1x2 BGN	N	N	90W	0.3M DV	Nordic (KB.1170A.045)	Danish/ Continental
AS5542G-323G32Mn	EMEA	Eastern Europe	LX.PHP0C.007	AS5542G-323G32Mn LINPUSAUE5 M92XT512Cbb_V3 2G+1G/320/BT/6L2.2/5R/CB_bgn_0.3D_HG_ENF1	AAM320	NLED15.6WXGAG	M92XT	512M-DDR3 (64*16*4)	SO2GBII6	N320GB5.4KS	NSM8XS	3rd WiFi 1x2 BGN	BT 2.1	N	90W	0.3M DV	US International (KB.1170A.056)	Continental
AS5542G-324G50Mn	EMEA	Eastern Europe	LX.PHP0C.006	AS5542G-324G50Mn LINPUSAUE5 M92XT512Cbb_V3 2*2G/500_L/BT/6L2.2/5R/CB_bgn_0.3D_HG_ENF1	AAM320	NLED15.6WXGAG	M92XT	512M-DDR3 (64*16*4)	SO2GBII6	N500GB5.4KS	NSM8XS	3rd WiFi 1x2 BGN	BT 2.1	N	90W	0.3M DV	US International (KB.1170A.056)	Continental
AS5542G-504G50Mi	EMEA	Russia	LX.PHP02.115	AS5542G-504G50Mi W7HP64RUATRU1 MC M92XT512Cbb_V3 2*2G/500_L/6L2.2/5R/CB_bgn_0.3D_HG_RU11	ATM500	NLED15.6WXGAG	M92XT	512M-DDR3 (64*16*4)	SO2GBII6	N500GB5.4KS	NSM8XS	3rd WiFi BG	N	N	90W	0.3M DV	Russian (KB.1170A.048)	Continental
AS5542G-504G50Mn	EMEA	Ukraine	LX.PHP02.114	AS5542G-504G50Mn W7HP64RUATUK1 MC M92XT512Cbb_V3 2*2G/500_L/6L2.2/5R/CB_bgn_0.3D_HG_RU61	ATM500	NLED15.6WXGAG	M92XT	512M-DDR3 (64*16*4)	SO2GBII6	N500GB5.4KS	NSM8XS	3rd WiFi 1x2 BGN	N	N	90W	0.3M DV	Russian (KB.1170A.048)	Continental
AS5542G-504G50Mn	EMEA	Middle East	LX.PHP02.113	AS5542G-504G50Mn EM W7HP64EMATME9 MC M92XT512Cbb_V3 2*2G/500_L/6L2.2/5R/CB_bgn_0.3D_HG_ES81	ATM500	NLED15.6WXGAG	M92XT	512M-DDR3 (64*16*4)	SO2GBII6	N500GB5.4KS	NSM8XS	3rd WiFi 1x2 BGN	N	N	90W	0.3M DV	FR/Arabic (KB.1170A.038)	Continental
AS5542G-504G50Mn	EMEA	South Africa	LX.PHP02.112	AS5542G-504G50Mn EM W7HP64EMATZA1 MC M92XT512Cbb_V3 2*2G/500_L/6L2.2/5R/CB_bgn_0.3D_HG_ES81	ATM500	NLED15.6WXGAG	M92XT	512M-DDR3 (64*16*4)	SO2GBII6	N500GB5.4KS	NSM8XS	3rd WiFi 1x2 BGN	N	N	90W	0.3M DV	French (KB.1170A.039)	Continental
AS5542G-504G50Mn	EMEA	Middle East	LX.PHP02.111	AS5542G-504G50Mn EM W7HP64EMATME2 MC M92XT512Cbb_V3 2*2G/500_L/6L2.2/5R/CB_bgn_0.3D_HG_ES61	ATM500	NLED15.6WXGAG	M92XT	512M-DDR3 (64*16*4)	SO2GBII6	N500GB5.4KS	NSM8XS	3rd WiFi 1x2 BGN	N	N	90W	0.3M DV	Arabic (KB.1170A.032)	UK and US-110V
AS5542G-504G50Mn	EMEA	South Africa	LX.PHP02.110	AS5542G-504G50Mn EM W7HP64EMATZA4 MC M92XT512Cbb_V3 2*2G/500_L/6L2.2/5R/CB_bgn_0.3D_HG_ES61	ATM500	NLED15.6WXGAG	M92XT	512M-DDR3 (64*16*4)	SO2GBII6	N500GB5.4KS	NSM8XS	3rd WiFi 1x2 BGN	N	N	90W	0.3M DV	US International (KB.1170A.056)	UK
AS5542G-504G50Mn	EMEA	Turkey	LX.PHP02.109	AS5542G-504G50Mn EM W7HP64EMATTR1 MC M92XT512Cbb_V3 2*2G/500_L/6L2.2/5R/CB_bgn_0.3D_HG_TR31	ATM500	NLED15.6WXGAG	M92XT	512M-DDR3 (64*16*4)	SO2GBII6	N500GB5.4KS	NSM8XS	3rd WiFi 1x2 BGN	N	N	90W	0.3M DV	Turkish (KB.1170A.054)	Continental

Model	RO	Country	Acer Part No	Description	CPU	LCD	VGA Chip	VRAM 1	Memory 1/ Memory 2	HDD 1(GB)	ODD	Wireless LAN1	Bluetooth	Finger Print	Adapter	Camera	K/B	Power Cord
AS5542G-504G50Mn	EMEA	South Africa	LX.PHP02.108	AS5542G-504G50Mn EM W7HP64EMATZ2 MC M92XT512Cbb_V3 2*2G/500_L/6L2.2/5R/CB_bgn_0.3D_HG_ES61	ATM500	NLED15.6WXGAG	M92XT	512M-DDR3 (64*16*4)	SO2GBII6	N500GB5.4KS	NSM8XS	3rd WiFi 1x2 BGN	N	N	90W	0.3M DV	US International (KB.I170A.056)	AF
AS5542G-504G50Mn	EMEA	Middle East	LX.PHP02.107	AS5542G-504G50Mn EM W7HP64EMATME6 MC M92XT512Cbb_V3 2*2G/500_L/6L2.2/5R/CB_bgn_0.3D_HG_ES61	ATM500	NLED15.6WXGAG	M92XT	512M-DDR3 (64*16*4)	SO2GBII6	N500GB5.4KS	NSM8XS	3rd WiFi 1x2 BGN	N	N	90W	0.3M DV	US International (KB.I170A.056)	UK
AS5542G-504G50Mn	EMEA	Middle East	LX.PHP02.106	AS5542G-504G50Mn EM W7HP64EMATME2 MC M92XT512Cbb_V3 2*2G/500_L/6L2.2/5R/CB_bgn_0.3D_HG_AR21	ATM500	NLED15.6WXGAG	M92XT	512M-DDR3 (64*16*4)	SO2GBII6	N500GB5.4KS	NSM8XS	3rd WiFi 1x2 BGN	N	N	90W	0.3M DV	Arabic (KB.I170A.032)	UK and US-110V
AS5542G-504G50Mn	EMEA	Middle East	LX.PHP02.105	AS5542G-504G50Mn EM W7HP64EMATME2 MC M92XT512Cbb_V3 2*2G/500_L/6L2.2/5R/CB_bgn_0.3D_HG_AR11	ATM500	NLED15.6WXGAG	M92XT	512M-DDR3 (64*16*4)	SO2GBII6	N500GB5.4KS	NSM8XS	3rd WiFi 1x2 BGN	N	N	90W	0.3M DV	Arabic (KB.I170A.032)	UK and US-110V
AS5542G-504G50Mn	EMEA	Middle East	LX.PHP02.104	AS5542G-504G50Mn EM W7HP64EMATME4 MC M92XT512Cbb_V3 2*2G/500_L/6L2.2/5R/CB_bgn_0.3D_HG_ES61	ATM500	NLED15.6WXGAG	M92XT	512M-DDR3 (64*16*4)	SO2GBII6	N500GB5.4KS	NSM8XS	3rd WiFi 1x2 BGN	N	N	90W	0.3M DV	Russian (KB.I170A.048)	Continental
AS5542G-504G50Mn	EMEA	Algeria	LX.PHP02.103	AS5542G-504G50Mn EM W7HP64EMATDZ1 MC M92XT512Cbb_V3 2*2G/500_L/6L2.2/5R/CB_bgn_0.3D_HG_ES81	ATM500	NLED15.6WXGAG	M92XT	512M-DDR3 (64*16*4)	SO2GBII6	N500GB5.4KS	NSM8XS	3rd WiFi 1x2 BGN	N	N	90W	0.3M DV	FR/Arabic (KB.I170A.038)	Continental
AS5542G-504G50Mn	EMEA	Hungary	LX.PHP02.102	AS5542G-504G50Mn W7HP64ATHU1 MC M92XT512Cbb_V3 2*2G/500_L/6L2.2/5R/CB_bgn_0.3D_HG_HU11	ATM500	NLED15.6WXGAG	M92XT	512M-DDR3 (64*16*4)	SO2GBII6	N500GB5.4KS	NSM8XS	3rd WiFi 1x2 BGN	N	N	90W	0.3M DV	Hungarian (KB.I170A.042)	Continental
AS5542G-504G50Mn	EMEA	Israel	LX.PHP02.101	AS5542G-504G50Mn W7HP64ATIL1 MC M92XT512Cbb_V3 2*2G/500_L/6L2.2/5R/CB_bgn_0.3D_HG_HE11	ATM500	NLED15.6WXGAG	M92XT	512M-DDR3 (64*16*4)	SO2GBII6	N500GB5.4KS	NSM8XS	3rd WiFi 1x2 BGN	N	N	90W	0.3M DV	US International w/ Hebrew (KB.I170A.057)	Israel
AS5542G-504G50Mn	EMEA	Portugal	LX.PHP02.099	AS5542G-504G50Mn W7HP64ATPT1 MC M92XT512Cbb_V3 2*2G/500_L/6L2.2/5R/CB_bgn_0.3D_HG_PT11	ATM500	NLED15.6WXGAG	M92XT	512M-DDR3 (64*16*4)	SO2GBII6	N500GB5.4KS	NSM8XS	3rd WiFi 1x2 BGN	N	N	90W	0.3M DV	Portuguese (KB.I170A.047)	Continental
AS5542G-504G50Mn	EMEA	Italy	LX.PHP02.097	AS5542G-504G50Mn W7HP64ATIT1 MC M92XT512Cbb_V3 2*2G/500_L/6L2.2/5R/CB_bgn_0.3D_HG_IT11	ATM500	NLED15.6WXGAG	M92XT	512M-DDR3 (64*16*4)	SO2GBII6	N500GB5.4KS	NSM8XS	3rd WiFi 1x2 BGN	N	N	90W	0.3M DV	Italian (KB.I170A.043)	Italian
AS5542G-504G50Mn	EMEA	France	LX.PHP02.098	AS5542G-504G50Mn W7HP64ATFR1 MC M92XT512Cbb_V3 2*2G/500_L/6L2.2/5R/CB_bgn_0.3D_HG_FR21	ATM500	NLED15.6WXGAG	M92XT	512M-DDR3 (64*16*4)	SO2GBII6	N500GB5.4KS	NSM8XS	3rd WiFi 1x2 BGN	N	N	90W	0.3M DV	French (KB.I170A.039)	Continental
AS5542G-504G50Mn	EMEA	Austria	LX.PHP02.096	AS5542G-504G50Mn W7HP64ATAT1 MC M92XT512Cbb_V3 2*2G/500_L/6L2.2/5R/CB_bgn_0.3D_HG_DE61	ATM500	NLED15.6WXGAG	M92XT	512M-DDR3 (64*16*4)	SO2GBII6	N500GB5.4KS	NSM8XS	3rd WiFi 1x2 BGN	N	N	90W	0.3M DV	German (KB.I170A.040)	Continental
AS5542G-504G50Mn	EMEA	Latvia	LX.PHP02.095	AS5542G-504G50Mn W7HP64ATLV1 MC M92XT512Cbb_V3 2*2G/500_L/6L2.2/5R/CB_bgn_0.3D_HG_RU22	ATM500	NLED15.6WXGAG	M92XT	512M-DDR3 (64*16*4)	SO2GBII6	N500GB5.4KS	NSM8XS	3rd WiFi 1x2 BGN	N	N	90W	0.3M DV	Russian (KB.I170A.048)	Continental
AS5542G-504G50Mn	EMEA	Holland	LX.PHP02.094	AS5542G-504G50Mn W7HP64ATNL1 MC M92XT512Cbb_V3 2*2G/500_L/6L2.2/5R/CB_bgn_0.3D_HG_NL11	ATM500	NLED15.6WXGAG	M92XT	512M-DDR3 (64*16*4)	SO2GBII6	N500GB5.4KS	NSM8XS	3rd WiFi 1x2 BGN	N	N	90W	0.3M DV	US International (KB.I170A.056)	Continental
AS5542G-504G50Mn	EMEA	Czech	LX.PHP02.092	AS5542G-504G50Mn W7HP64ATCZ2 MC M92XT512Cbb_V3 2*2G/500_L/6L2.2/5R/CB_bgn_0.3D_HG_SK11	ATM500	NLED15.6WXGAG	M92XT	512M-DDR3 (64*16*4)	SO2GBII6	N500GB5.4KS	NSM8XS	3rd WiFi 1x2 BGN	N	N	90W	0.3M DV	CZ/SK (KB.I170A.035)	Continental
AS5542G-504G50Mn	EMEA	Eastern Europe	LX.PHP02.093	AS5542G-504G50Mn W7HP64ATEU7 MC M92XT512Cbb_V3 2*2G/500_L/6L2.2/5R/CB_bgn_0.3D_HG_ENQ1	ATM500	NLED15.6WXGAG	M92XT	512M-DDR3 (64*16*4)	SO2GBII6	N500GB5.4KS	NSM8XS	3rd WiFi 1x2 BGN	N	N	90W	0.3M DV	SLO/CRO (KB.I170A.049)	Continental
AS5542G-504G50Mn	EMEA	Denmark	LX.PHP02.091	AS5542G-504G50Mn W7HP64ATDK2 MC M92XT512Cbb_V3 2*2G/500_L/6L2.2/5R/CB_bgn_0.3D_HG_ENS1	ATM500	NLED15.6WXGAG	M92XT	512M-DDR3 (64*16*4)	SO2GBII6	N500GB5.4KS	NSM8XS	3rd WiFi 1x2 BGN	N	N	90W	0.3M DV	Nordic (KB.I170A.045)	Danish/ Continental
AS5542G-504G50Mn	EMEA	Middle East	LX.PHP02.090	AS5542G-504G50Mn EM W7HP64EMATME4 MC M92XT512Cbb_V3 2*2G/500_L/6L2.2/5R/CB_bgn_0.3D_HG_RU61	ATM500	NLED15.6WXGAG	M92XT	512M-DDR3 (64*16*4)	SO2GBII6	N500GB5.4KS	NSM8XS	3rd WiFi 1x2 BGN	N	N	90W	0.3M DV	Russian (KB.I170A.048)	Continental

Model	RO	Country	Acer Part No	Description	CPU	LCD	VGA Chip	VRAM 1	Memory 1/ Memory 2	HDD 1 (GB)	ODD	Wireless LAN1	Bluetooth	Finger Print	Adapter	Camera	K/B	Power Cord
AS5542G-504G50Mn	EMEA	Middle East	LX.PHP02.089	AS5542G-504G50Mn Em W7HP64EMATME3 MC M92XT512Cbb_V3 2*2G/500_L/6L2.2/5R/CB_bgn_0.3D_HG_ESB1	ATM500	NLED15.6WXGAG	M92XT	512M-DDR3 (64*16*4)	SO2GBII6	N500GB5.4KS	NSM8XS	3rd WiFi 1x2 BGN	N	N	90W	0.3M DV	French (KB.I170A.039)	Continental
AS5542G-504G50Mn	EMEA	Belgium	LX.PHP02.088	AS5542G-504G50Mn W7HP64ATBE1 MC M92XT512Cbb_V3 2*2G/500_L/6L2.2/5R/CB_bgn_0.3D_HG_NL11	ATM500	NLED15.6WXGAG	M92XT	512M-DDR3 (64*16*4)	SO2GBII6	N500GB5.4KS	NSM8XS	3rd WiFi 1x2 BGN	N	N	90W	0.3M DV	Belgium (KB.I170A.033)	Continental
AS5542G-504G50Mn	EMEA	Eastern Europe	LX.PHP02.087	AS5542G-504G50Mn W7HP64ATEU5 MC M92XT512Cbb_V3 2*2G/500_L/6L2.2/5R/CB_bgn_0.3D_HG_RO11	ATM500	NLED15.6WXGAG	M92XT	512M-DDR3 (64*16*4)	SO2GBII6	N500GB5.4KS	NSM8XS	3rd WiFi 1x2 BGN	N	N	90W	0.3M DV	US International (KB.I170A.056)	Continental
AS5542G-504G50Mn	EMEA	Cyprus	LX.PHP02.086	AS5542G-504G50Mn W7HP64ATCY1 MC M92XT512Cbb_V3 2*2G/500_L/6L2.2/5R/CB_bgn_0.3D_HG_ES61	ATM500	NLED15.6WXGAG	M92XT	512M-DDR3 (64*16*4)	SO2GBII6	N500GB5.4KS	NSM8XS	3rd WiFi 1x2 BGN	N	N	90W	0.3M DV	UK (KB.I170A.055)	UK
AS5542G-504G50Mn	EMEA	Eastern Europe	LX.PHP02.085	AS5542G-504G50Mn W7HP64ATEU5 MC M92XT512Cbb_V3 2*2G/500_L/6L2.2/5R/CB_bgn_0.3D_HG_PL71	ATM500	NLED15.6WXGAG	M92XT	512M-DDR3 (64*16*4)	SO2GBII6	N500GB5.4KS	NSM8XS	3rd WiFi 1x2 BGN	N	N	90W	0.3M DV	US International (KB.I170A.056)	Continental
AS5542G-504G50Mn	EMEA	Eastern Europe	LX.PHP02.084	AS5542G-504G50Mn W7HP64ATEU4 MC M92XT512Cbb_V3 2*2G/500_L/6L2.2/5R/CB_bgn_0.3D_HG_SV21	ATM500	NLED15.6WXGAG	M92XT	512M-DDR3 (64*16*4)	SO2GBII6	N500GB5.4KS	NSM8XS	3rd WiFi 1x2 BGN	N	N	90W	0.3M DV	Sweden (KB.I170A.051)	Continental
AS5542G-504G50Mn	EMEA	Poland	LX.PHP02.083	AS5542G-504G50Mn W7HP64ATPL1 MC M92XT512Cbb_V3 2*2G/500_L/6L2.2/5R/CB_bgn_0.3D_HG_PL11	ATM500	NLED15.6WXGAG	M92XT	512M-DDR3 (64*16*4)	SO2GBII6	N500GB5.4KS	NSM8XS	3rd WiFi 1x2 BGN	N	N	90W	0.3M DV	US International (KB.I170A.056)	Continental
AS5542G-504G50Mn	EMEA	UK	LX.PHP02.082	AS5542G-504G50Mn W7HP64ATGB1 MC M92XT512Cbb_V3 2*2G/500_L/6L2.2/5R/CB_bgn_0.3D_HG_EN11	ATM500	NLED15.6WXGAG	M92XT	512M-DDR3 (64*16*4)	SO2GBII6	N500GB5.4KS	NSM8XS	3rd WiFi 1x2 BGN	N	N	90W	0.3M DV	UK (KB.I170A.055)	UK
AS5542G-504G50Mn	EMEA	Greece	LX.PHP02.081	AS5542G-504G50Mn W7HP64ATR1 MC M92XT512Cbb_V3 2*2G/500_L/6L2.2/5R/CB_bgn_0.3D_HG_EL31	ATM500	NLED15.6WXGAG	M92XT	512M-DDR3 (64*16*4)	SO2GBII6	N500GB5.4KS	NSM8XS	3rd WiFi 1x2 BGN	N	N	90W	0.3M DV	Greek (KB.I170A.041)	Continental
AS5542G-504G50Mn	EMEA	Serbia/Macedonia	LX.PHP02.080	AS5542G-504G50Mn W7HP64ATCS1 MC M92XT512Cbb_V3 2*2G/500_L/6L2.2/5R/CB_bgn_0.3D_HG_SL11	ATM500	NLED15.6WXGAG	M92XT	512M-DDR3 (64*16*4)	SO2GBII6	N500GB5.4KS	NSM8XS	3rd WiFi 1x2 BGN	N	N	90W	0.3M DV	SLO/CRO (KB.I170A.049)	Continental
AS5542G-504G50Mn	EMEA	Switzerland	LX.PHP02.079	AS5542G-504G50Mn W7HP64ATCH1 MC M92XT512Cbb_V3 2*2G/500_L/6L2.2/5R/CB_bgn_0.3D_HG_IT41	ATM500	NLED15.6WXGAG	M92XT	512M-DDR3 (64*16*4)	SO2GBII6	N500GB5.4KS	NSM8XS	3rd WiFi 1x2 BGN	N	N	90W	0.3M DV	Swiss/G (KB.I170A.052)	Swiss
AS5542G-504G50Mn	EMEA	Luxembourg	LX.PHP02.078	AS5542G-504G50Mn W7HP64ATLU3 MC M92XT512Cbb_V3 2*2G/500_L/6L2.2/5R/CB_bgn_0.3D_HG_IT41	ATM500	NLED15.6WXGAG	M92XT	512M-DDR3 (64*16*4)	SO2GBII6	N500GB5.4KS	NSM8XS	3rd WiFi 1x2 BGN	N	N	90W	0.3M DV	Swiss/G (KB.I170A.052)	Continental
AS5542G-504G50Mn	EMEA	Eastern Europe	LX.PHP02.077	AS5542G-504G50Mn W7HP64ATEU7 MC M92XT512Cbb_V3 2*2G/500_L/6L2.2/5R/CB_bgn_0.3D_HG_SL11	ATM500	NLED15.6WXGAG	M92XT	512M-DDR3 (64*16*4)	SO2GBII6	N500GB5.4KS	NSM8XS	3rd WiFi 1x2 BGN	N	N	90W	0.3M DV	SLO/CRO (KB.I170A.049)	Continental
AS5542G-304G32Bn	EMEA	UK	LX.PHP02.076	AS5542G-304G32Bn W7HP64ATGB1 MC M92XT512Cbb_V3 2*2G/320/6L2.2/5R/CB_bgn_0.3D_HG_EN11	AAM300	NLED15.6WXGAG	M92XT	512M-DDR3 (64*16*4)	SO2GBII6	N320GB5.4KS	NBDCB4XS	3rd WiFi 1x2 BGN	N	N	90W	0.3M DV	UK (KB.I170A.055)	UK
AS5542G-304G32Mn	EMEA	Eastern Europe	LX.PHP02.037	AS5542G-304G32Mn W7HP64ATEU5 MC M92XT512Cbb_V3 2*2G/320/6L2.2/5R/CB_bgn_0.3D_HG_RO11	AAM300	NLED15.6WXGAG	M92XT	512M-DDR3 (64*16*4)	SO2GBII6	N320GB5.4KS	NSM8XS	3rd WiFi 1x2 BGN	N	N	90W	0.3M DV	US International (KB.I170A.056)	Continental
AS5542G-304G32Mn	AAP	Australia/New Zealand	LX.PHP02.073	AS5542G-304G32Mn W7HP64ATAU1 MC M92XT512Cbb_V3 2*2G/320/6L2.2/5R/CB_bgn_0.3D_HG_ES61	AAM300	NLED15.6WXGAG	M92XT	512M-DDR3 (64*16*4)	SO2GBII6	N320GB5.4KS	NSM8XS	3rd WiFi 1x2 BGN	BT 2.1	N	90W	0.3M DV	US International (KB.I170A.056)	Australia w/ label
AS5542G-303G25Mn	EMEA	France	LX.PHP02.074	AS5542G-303G25Mn W7HP64ATFR1 MC M92XT512Cbb_V3 2G+1G/250/6L2.2/5R/CB_bgn_0.3D_HG_FR21	AAM300	NLED15.6WXGAG	M92XT	512M-DDR3 (64*16*4)	SO2GBII6	N250GB5.4KS	NSM8XS	3rd WiFi 1x2 BGN	N	N	90W	0.3M DV	French (KB.I170A.039)	Continental
AS5542G-323G25Mn	EMEA	Eastern Europe	LX.PHP0C.008	AS5542G-323G25Mn LINPUSAEU5 M92XT512Cbb_V3 2G+1G/250/6L2.2/5R/CB_bgn_0.3D_HG_ENF1	AAM320	NLED15.6WXGAG	M92XT	512M-DDR3 (64*16*4)	SO2GBII6	N250GB5.4KS	NSM8XS	3rd WiFi 1x2 BGN	BT 2.1	N	90W	0.3M DV	US International (KB.I170A.056)	Continental
AS5542G-504G50Mn	EMEA	Czech	LX.PHP0C.004	AS5542G-504G50Mn LINPUSACZ2 M92XT512Cbb_V3 2*2G/500_L/6L2.2/5R/CB_bgn_0.3D_HG_EN22	ATM500	NLED15.6WXGAG	M92XT	512M-DDR3 (64*16*4)	SO2GBII6	N500GB5.4KS	NSM8XS	3rd WiFi 1x2 BGN	BT 2.1	N	90W	0.3M DV	CZ/SK (KB.I170A.035)	Continental
AS5542G-303G32Mn	EMEA	Latvia	LX.PHP0C.002	AS5542G-303G32Mn LINPUSALV1 M92XT512Cbb_V3 2G+1G/320/6L2.2/5R/CB_bgn_0.3D_HG_EN71	AAM300	NLED15.6WXGAG	M92XT	512M-DDR3 (64*16*4)	SO2GBII6	N320GB5.4KS	NSM8XS	3rd WiFi 1x2 BGN	BT 2.1	N	90W	0.3M DV	Russian (KB.I170A.048)	Continental

Model	RO	Country	Acer Part No	Description	CPU	LCD	VGA Chip	VRAM 1	Memory 1/ Memory 2	HDD 1 (GB)	ODD	Wireless LAN1	Bluetooth	Finger Print	Adapter	Camera	K/B	Power Cord
AS5542G-304G32Mn	EMEA	Ukraine	LX.PHP02.003	AS5542G-304G32Mn W7HP64RUATUK1 MC M92XT512Cbb_V3 2*2G/320/6L2.2/5R/CB_bgn_0.3D_HG_RU61	AAM300	NLED15.6WXGAG	M92XT	512M-DDR3 (64*16*4)	SO2GBII6	N320GB5.4KS	NSM8XS	3rd WiFi 1x2 BGN	N	N	90W	0.3M DV	Russian (KB.I170A.048)	Continental
AS5542G-504G50Mn	AAP	Australia/ New Zealand	LX.PHP02.069	AS5542G-504G50Mn W7HP64ATAU1 MC M92XT512Cbb_V3 2*2G/500_L/6L2.2/5R/CB_bgn_0.3D_HG_ES61	ATM500	NLED15.6WXGAG	M92XT	512M-DDR3 (64*16*4)	SO2GBII6	N500GB5.4KS	NSM8XS	3rd WiFi 1x2 BGN	N	N	90W	0.3M DV	US International (KB.I170A.056)	Australia w/ label
AS5542G-324G50Mn	AAP	Australia/ New Zealand	LX.PHP02.068	AS5542G-324G50Mn W7HP64ATAU1 MC M92XT512Cbb_V3 2*2G/500_L/6L2.2/5R/CB_bgn_0.3D_HG_ES61	AAM320	NLED15.6WXGAG	M92XT	512M-DDR3 (64*16*4)	SO2GBII6	N500GB5.4KS	NSM8XS	3rd WiFi 1x2 BGN	N	N	90W	0.3M DV	US International (KB.I170A.056)	Australia w/ label
AS5542G-304G50Mn	AAP	Australia/ New Zealand	LX.PHP02.067	AS5542G-304G50Mn W7HP64ATAU1 MC M92XT512Cbb_V3 2*2G/500_L/6L2.2/5R/CB_bgn_0.3D_HG_ES61	AAM300	NLED15.6WXGAG	M92XT	512M-DDR3 (64*16*4)	SO2GBII6	N500GB5.4KS	NSM8XS	3rd WiFi 1x2 BGN	BT 2.1	N	90W	0.3M DV	US International (KB.I170A.056)	Australia w/ label
AS5542G-303G25Mn	EMEA	Israel	LX.PHP02.065	AS5542G-303G25Mn W7HP64ATIL1 MC M92XT512Cbb_V3 2G+1G/250/6L2.2/5R/CB_bgn_0.3D_HG_HE11	AAM300	NLED15.6WXGAG	M92XT	512M-DDR3 (64*16*4)	SO2GBII6	N250GB5.4KS	NSM8XS	3rd WiFi 1x2 BGN	N	N	90W	0.3M DV	US International w/ Hebrew (KB.I170A.057)	Israel
AS5542G-303G25Mn	EMEA	Israel	LX.PHP02.064	AS5542G-303G25Mn W7HP64ATIL1 MC M92XT512Cbb_V3 2G+1G/250/6L2.2/5R/CB_bgn_0.3D_HG_HE31	AAM300	NLED15.6WXGAG	M92XT	512M-DDR3 (64*16*4)	SO2GBII6	N250GB5.4KS	NSM8XS	3rd WiFi 1x2 BGN	N	N	90W	0.3M DV	US International w/ Hebrew (KB.I170A.057)	Israel
AS5542G-303G25Mn	EMEA	Cyprus	LX.PHP02.063	AS5542G-303G25Mn W7HP64ATCY1 MC M92XT512Cbb_V3 2G+1G/250/6L2.2/5R/CB_bgn_0.3D_HG_ES61	AAM300	NLED15.6WXGAG	M92XT	512M-DDR3 (64*16*4)	SO2GBII6	N250GB5.4KS	NSM8XS	3rd WiFi 1x2 BGN	N	N	90W	0.3M DV	UK (KB.I170A.055)	UK
AS5542G-303G25Mn	EMEA	Greece	LX.PHP02.061	AS5542G-303G25Mn W7HP64ATGR1 MC M92XT512Cbb_V3 2G+1G/250/6L2.2/5R/CB_bgn_0.3D_HG_EL31	AAM300	NLED15.6WXGAG	M92XT	512M-DDR3 (64*16*4)	SO2GBII6	N250GB5.4KS	NSM8XS	3rd WiFi 1x2 BGN	N	N	90W	0.3M DV	Greek (KB.I170A.041)	Continental
AS5542G-504G50Mn	EMEA	Czech	LX.PHP02.060	AS5542G-504G50Mn W7HP64ATCZ2 MC M92XT512Cbb_V3 2*2G/500_L/6L2.2/5R/CB_bgn_0.3D_HG_SK11	ATM500	NLED15.6WXGAG	M92XT	512M-DDR3 (64*16*4)	SO2GBII6	N500GB5.4KS	NSM8XS	3rd WiFi 1x2 BGN	BT 2.1	N	90W	0.3M DV	CZ/SK (KB.I170A.035)	Continental
AS5542G-304G50Mn	EMEA	Norway	LX.PHP02.058	AS5542G-304G50Mn W7HP64ATNO3 MC M92XT512Cbb_V3 2*2G/500_L/6L2.2/5R/CB_bgn_0.3D_HG_ENS1	AAM300	NLED15.6WXGAG	M92XT	512M-DDR3 (64*16*4)	SO2GBII6	N500GB5.4KS	NSM8XS	3rd WiFi 1x2 BGN	BT 2.1	N	90W	0.3M DV	Nordic (KB.I170A.045)	Danish/ Continental
AS5542G-303G32Mn	EMEA	Eastern Europe	LX.PHP0C.003	AS5542G-303G32Mn LNPUSAEU5 M92XT512Cbb_V3 2G+1G/320/6L2.2/5R/CB_bgn_0.3D_HG_ENF1	AAM300	NLED15.6WXGAG	M92XT	512M-DDR3 (64*16*4)	SO2GBII6	N320GB5.4KS	NSM8XS	3rd WiFi 1x2 BGN	BT 2.1	N	90W	0.3M DV	US International (KB.I170A.056)	Continental
AS5542G-303G32Mn	EMEA	Eastern Europe	LX.PHP02.057	AS5542G-303G32Mn W7HP64ATEU5 MC M92XT512Cbb_V3 2G+1G/320/6L2.2/5R/CB_bgn_0.3D_HG_RO11	AAM300	NLED15.6WXGAG	M92XT	512M-DDR3 (64*16*4)	SO2GBII6	N320GB5.4KS	NSM8XS	3rd WiFi 1x2 BGN	BT 2.1	N	90W	0.3M DV	US International (KB.I170A.056)	Continental
AS5542G-304G50Bn	EMEA	Denmark	LX.PHP02.056	AS5542G-304G50Bn W7HP64ATDK2 MC M92XT512Cbb_V3 2*2G/500_L/6L2.2/5R/CB_bgn_0.3D_HG_ENS1	AAM300	NLED15.6WXGAG	M92XT	512M-DDR3 (64*16*4)	SO2GBII6	N500GB5.4KS	NBDCB4 XS	3rd WiFi 1x2 BGN	N	N	90W	0.3M DV	Nordic (KB.I170A.045)	Danish/ Continental
AS5542G-304G50Mn	EMEA	Germany	LX.PHP02.048	AS5542G-304G50Mn W7HP64ATDE1 MC M92XT512Cbb_V3 2*2G/500_L/6L2.2/5R/CB_bgn_0.3D_HG_DE11	AAM300	NLED15.6WXGAG	M92XT	512M-DDR3 (64*16*4)	SO2GBII6	N500GB5.4KS	NSM8XS	3rd WiFi 1x2 BGN	N	N	90W	0.3M DV	German (KB.I170A.040)	Continental
AS5542G-304G32Mn	EMEA	Middle East	LX.PHP02.007	AS5542G-304G32Mn Em W7HP64MATMEJ2 MC M92XT512Cbb_V3 2*2G/320/6L2.2/5R/CB_bgn_0.3D_HG_AR21	AAM300	NLED15.6WXGAG	M92XT	512M-DDR3 (64*16*4)	SO2GBII6	N320GB5.4KS	NSM8XS	3rd WiFi 1x2 BGN	N	N	90W	0.3M DV	Arabic (KB.I170A.032)	UK and US-110V
AS5542G-504G50Mn	EMEA	Spain	LX.PHP02.054	AS5542G-504G50Mn W7HP64ATES1 MC M92XT512Cbb_V3 2*2G/500_L/6L2.2/5R/CB_bgn_0.3D_HG_ES51	ATM500	NLED15.6WXGAG	M92XT	512M-DDR3 (64*16*4)	SO2GBII6	N500GB5.4KS	NSM8XS	3rd WiFi 1x2 BGN	N	N	90W	0.3M DV	Spanish (KB.I170A.050)	Continental
AS5542G-304G50Mn	EMEA	Switzerland	LX.PHP02.053	AS5542G-304G50Mn W7HP64ATCH1 MC M92XT512Cbb_V3 2*2G/500_L/6L2.2/5R/CB_bgn_0.3D_HG_IT41	AAM300	NLED15.6WXGAG	M92XT	512M-DDR3 (64*16*4)	SO2GBII6	N500GB5.4KS	NSM8XS	3rd WiFi 1x2 BGN	N	N	90W	0.3M DV	Swiss/G (KB.I170A.052)	Swiss
AS5542G-304G32Mi	EMEA	Russia	LX.PHP01.002	AS5542G-304G32Mi W7HB64RUATRU1 MC M92XT512Cbb_V3 2*2G/320/6L2.2/5R/CB_bgn_0.3D_HG_RU11	AAM300	NLED15.6WXGAG	M92XT	512M-DDR3 (64*16*4)	SO2GBII6	N320GB5.4KS	NSM8XS	3rd WiFi BG	N	N	90W	0.3M DV	Russian (KB.I170A.048)	Continental
AS5542G-504G50Mn	EMEA	Germany	LX.PHP02.050	AS5542G-504G50Mn W7HP64ATDE1 MC M92XT512Cbb_V3 2*2G/500_L/6L2.2/5R/CB_bgn_0.3D_HG_DE11	ATM500	NLED15.6WXGAG	M92XT	512M-DDR3 (64*16*4)	SO2GBII6	N500GB5.4KS	NSM8XS	3rd WiFi 1x2 BGN	N	N	90W	0.3M DV	German (KB.I170A.040)	Continental
AS5542G-302G32Mn	AAP	Japan	LX.PHP02.046	AS5542G-302G32Mn W7HP64AJ1P MC M92XT512Cbb_V3 1*2G/320/6L2.2/5R/CB_bgn_0.3D_HG_JA11_M92	AAM300	NLED15.6WXGAG	M92XT	512M-DDR3 (64*16*4)	SO2GBII6/N	N320GB5.4KS	NSM8XS	3rd WiFi 1x2 BGN	BT 2.1	N	90W	0.3M DV	Japanese (KB.I170A.044)	Japanese power cord

Model	RO	Country	Acer Part No	Description	CPU	LCD	VGA Chip	VRAM 1	Memory 1/ Memory 2	HDD 1(GB)	ODD	Wireless LAN1	Bluetooth	Finger Print	Adapter	Camera	K/B	Power Cord
AS5542G-303G32Mn	EMEA	UK	LX.PHP02.045	AS5542G-303G32Mn W7HP64ATGB1 MC M92XT512Cbb_V3 2*2G/320/6L2.2/5R/CB_bgn_0_3D_HG_EN11	AAM300	NLED15.6WXGAG	M92XT	512M-DDR3 (64*16*4)	SO2GBII6	N320GB5.4KS	NSM8XS	3rd WiFi 1x2 BGN	N	N	90W	0.3M DV	UK (KB.I170A.055)	UK
AS5542G-304G32Mn	EMEA	Turkey	LX.PHP02.005	AS5542G-304G32Mn EM W7HP64EMATTR1 MC M92XT512Cbb_V3 2*2G/320/6L2.2/5R/CB_bgn_0_3D_HG_TR31	AAM300	NLED15.6WXGAG	M92XT	512M-DDR3 (64*16*4)	SO2GBII6	N320GB5.4KS	NSM8XS	3rd WiFi 1x2 BGN	N	N	90W	0.3M DV	Turkish (KB.I170A.054)	Continental
AS5542G-304G32Mn	EMEA	Middle East	LX.PHP02.010	AS5542G-304G32Mn EM W7HP64EMATME2 MC M92XT512Cbb_V3 2*2G/320/6L2.2/5R/CB_bgn_0_3D_HG_AR11	AAM300	NLED15.6WXGAG	M92XT	512M-DDR3 (64*16*4)	SO2GBII6	N320GB5.4KS	NSM8XS	3rd WiFi 1x2 BGN	N	N	90W	0.3M DV	Arabic (KB.I170A.032)	UK and US-110V
AS5542G-304G32Mn	EMEA	Middle East	LX.PHP02.008	AS5542G-304G32Mn EM W7HP64EMATME4 MC M92XT512Cbb_V3 2*2G/320/6L2.2/5R/CB_bgn_0_3D_HG_RU61	AAM300	NLED15.6WXGAG	M92XT	512M-DDR3 (64*16*4)	SO2GBII6	N320GB5.4KS	NSM8XS	3rd WiFi 1x2 BGN	N	N	90W	0.3M DV	Russian (KB.I170A.048)	Continental
AS5542G-304G32Mn	EMEA	Middle East	LX.PHP02.009	AS5542G-304G32Mn EM W7HP64EMATME4 MC M92XT512Cbb_V3 2*2G/320/6L2.2/5R/CB_bgn_0_3D_HG_ES61	AAM300	NLED15.6WXGAG	M92XT	512M-DDR3 (64*16*4)	SO2GBII6	N320GB5.4KS	NSM8XS	3rd WiFi 1x2 BGN	N	N	90W	0.3M DV	Russian (KB.I170A.048)	Continental
AS5542G-304G32Mn	EMEA	Middle East	LX.PHP02.011	AS5542G-304G32Mn EM W7HP64EMATME3 MC M92XT512Cbb_V3 2*2G/320/6L2.2/5R/CB_bgn_0_3D_HG_ES81	AAM300	NLED15.6WXGAG	M92XT	512M-DDR3 (64*16*4)	SO2GBII6	N320GB5.4KS	NSM8XS	3rd WiFi 1x2 BGN	N	N	90W	0.3M DV	French (KB.I170A.039)	Continental
AS5542G-304G32Mn	EMEA	Middle East	LX.PHP02.006	AS5542G-304G32Mn EM W7HP64EMATME6 MC M92XT512Cbb_V3 2*2G/320/6L2.2/5R/CB_bgn_0_3D_HG_ES61	AAM300	NLED15.6WXGAG	M92XT	512M-DDR3 (64*16*4)	SO2GBII6	N320GB5.4KS	NSM8XS	3rd WiFi 1x2 BGN	N	N	90W	0.3M DV	US International (KB.I170A.056)	UK
AS5542G-304G32Mn	EMEA	Middle East	LX.PHP02.012	AS5542G-304G32Mn EM W7HP64EMATME2 MC M92XT512Cbb_V3 2*2G/320/6L2.2/5R/CB_bgn_0_3D_HG_ES61	AAM300	NLED15.6WXGAG	M92XT	512M-DDR3 (64*16*4)	SO2GBII6	N320GB5.4KS	NSM8XS	3rd WiFi 1x2 BGN	N	N	90W	0.3M DV	Arabic (KB.I170A.032)	UK and US-110V
AS5542G-304G32Mn	EMEA	South Africa	LX.PHP02.015	AS5542G-304G32Mn EM W7HP64EMATZA1 MC M92XT512Cbb_V3 2*2G/320/6L2.2/5R/CB_bgn_0_3D_HG_ES81	AAM300	NLED15.6WXGAG	M92XT	512M-DDR3 (64*16*4)	SO2GBII6	N320GB5.4KS	NSM8XS	3rd WiFi 1x2 BGN	N	N	90W	0.3M DV	French (KB.I170A.039)	Continental
AS5542G-304G32Mn	EMEA	Algeria	LX.PHP02.013	AS5542G-304G32Mn EM W7HP64EMATDZ1 MC M92XT512Cbb_V3 2*2G/320/6L2.2/5R/CB_bgn_0_3D_HG_ES81	AAM300	NLED15.6WXGAG	M92XT	512M-DDR3 (64*16*4)	SO2GBII6	N320GB5.4KS	NSM8XS	3rd WiFi 1x2 BGN	N	N	90W	0.3M DV	FR/Arabic (KB.I170A.038)	Continental
AS5542G-304G32Mn	EMEA	Middle East	LX.PHP02.017	AS5542G-304G32Mn EM W7HP64EMATME9 MC M92XT512Cbb_V3 2*2G/320/6L2.2/5R/CB_bgn_0_3D_HG_ES81	AAM300	NLED15.6WXGAG	M92XT	512M-DDR3 (64*16*4)	SO2GBII6	N320GB5.4KS	NSM8XS	3rd WiFi 1x2 BGN	N	N	90W	0.3M DV	FR/Arabic (KB.I170A.038)	Continental
AS5542G-304G32Mn	EMEA	South Africa	LX.PHP02.014	AS5542G-304G32Mn EM W7HP64EMATZA2 MC M92XT512Cbb_V3 2*2G/320/6L2.2/5R/CB_bgn_0_3D_HG_ES61	AAM300	NLED15.6WXGAG	M92XT	512M-DDR3 (64*16*4)	SO2GBII6	N320GB5.4KS	NSM8XS	3rd WiFi 1x2 BGN	N	N	90W	0.3M DV	US International (KB.I170A.056)	AF
AS5542G-304G32Mn	EMEA	South Africa	LX.PHP02.016	AS5542G-304G32Mn EM W7HP64EMATZA4 MC M92XT512Cbb_V3 2*2G/320/6L2.2/5R/CB_bgn_0_3D_HG_ES61	AAM300	NLED15.6WXGAG	M92XT	512M-DDR3 (64*16*4)	SO2GBII6	N320GB5.4KS	NSM8XS	3rd WiFi 1x2 BGN	N	N	90W	0.3M DV	US International (KB.I170A.056)	UK
AS5542G-304G32Mn	EMEA	Switzerland	LX.PHP02.019	AS5542G-304G32Mn W7HP64ATCH1 MC M92XT512Cbb_V3 2*2G/320/6L2.2/5R/CB_bgn_0_3D_HG_IT41	AAM300	NLED15.6WXGAG	M92XT	512M-DDR3 (64*16*4)	SO2GBII6	N320GB5.4KS	NSM8XS	3rd WiFi 1x2 BGN	N	N	90W	0.3M DV	Swiss/G (KB.I170A.052)	Swiss
AS5542G-304G32Mn	EMEA	UK	LX.PHP02.018	AS5542G-304G32Mn W7HP64ATGB1 MC M92XT512Cbb_V3 2*2G/320/6L2.2/5R/CB_bgn_0_3D_HG_EN11	AAM300	NLED15.6WXGAG	M92XT	512M-DDR3 (64*16*4)	SO2GBII6	N320GB5.4KS	NSM8XS	3rd WiFi 1x2 BGN	N	N	90W	0.3M DV	UK (KB.I170A.055)	UK
AS5542G-304G32Mn	EMEA	Greece	LX.PHP02.021	AS5542G-304G32Mn W7HP64ATGR1 MC M92XT512Cbb_V3 2*2G/320/6L2.2/5R/CB_bgn_0_3D_HG_EL31	AAM300	NLED15.6WXGAG	M92XT	512M-DDR3 (64*16*4)	SO2GBII6	N320GB5.4KS	NSM8XS	3rd WiFi 1x2 BGN	N	N	90W	0.3M DV	Greek (KB.I170A.041)	Continental
AS5542G-304G32Mn	EMEA	Italy	LX.PHP02.043	AS5542G-304G32Mn W7HP64ATIT1 MC M92XT512Cbb_V3 2*2G/320/6L2.2/5R/CB_bgn_0_3D_HG_IT11	AAM300	NLED15.6WXGAG	M92XT	512M-DDR3 (64*16*4)	SO2GBII6	N320GB5.4KS	NSM8XS	3rd WiFi 1x2 BGN	N	N	90W	0.3M DV	Italian (KB.I170A.043)	Italian

Model	RO	Country	Acer Part No	Description	CPU	LCD	VGA Chip	VRAM 1	Memory 1/ Memory 2	HDD 1 (GB)	ODD	Wireless LAN1	Bluetooth	Finger Print	Adapter	Camera	K/B	Power Cord
AS5542G-304G32Mn	EMEA	Cyprus	LX.PHP02.042	AS5542G-304G32Mn W7HP64ATCY1 MC M92XT512Cbb_V3 2*2G/320/6L2.2/5R/CB_bgn_0.3D_HG_ES61	AAM300	NLED15.6WXGAG	M92XT	512M-DDR3 (64*16*4)	SO2GBII6	N320GB5.4KS	NSM8XS	3rd WiFi 1x2 BGN	N	N	90W	0.3M DV	UK (KB.I170A.055)	UK
AS5542G-304G32Mn	EMEA	Finland	LX.PHP02.038	AS5542G-304G32Mn W7HP64ATF12 MC M92XT512Cbb_V3 2*2G/320/6L2.2/5R/CB_bgn_0.3D_HG_F11	AAM300	NLED15.6WXGAG	M92XT	512M-DDR3 (64*16*4)	SO2GBII6	N320GB5.4KS	NSM8XS	3rd WiFi 1x2 BGN	N	N	90W	0.3M DV	Sweden (KB.I170A.051)	Continental
AS5542G-304G32Mn	EMEA	Portugal	LX.PHP02.040	AS5542G-304G32Mn W7HP64ATPT1 MC M92XT512Cbb_V3 2*2G/320/6L2.2/5R/CB_bgn_0.3D_HG_PT11	AAM300	NLED15.6WXGAG	M92XT	512M-DDR3 (64*16*4)	SO2GBII6	N320GB5.4KS	NSM8XS	3rd WiFi 1x2 BGN	N	N	90W	0.3M DV	Portuguese (KB.I170A.047)	Continental
AS5542G-304G32Mn	EMEA	Spain	LX.PHP02.041	AS5542G-304G32Mn W7HP64ATES1 MC M92XT512Cbb_V3 2*2G/320/6L2.2/5R/CB_bgn_0.3D_HG_ES51	AAM300	NLED15.6WXGAG	M92XT	512M-DDR3 (64*16*4)	SO2GBII6	N320GB5.4KS	NSM8XS	3rd WiFi 1x2 BGN	N	N	90W	0.3M DV	Spanish (KB.I170A.050)	Continental
AS5542G-304G32Mn	EMEA	Eastern Europe	LX.PHP02.036	AS5542G-304G32Mn W7HP64ATEU4 MC M92XT512Cbb_V3 2*2G/320/6L2.2/5R/CB_bgn_0.3D_HG_SVZ1	AAM300	NLED15.6WXGAG	M92XT	512M-DDR3 (64*16*4)	SO2GBII6	N320GB5.4KS	NSM8XS	3rd WiFi 1x2 BGN	N	N	90W	0.3M DV	Sweden (KB.I170A.051)	Continental
AS5542G-304G32Mn	EMEA	Eastern Europe	LX.PHP02.035	AS5542G-304G32Mn W7HP64ATEU7 MC M92XT512Cbb_V3 2*2G/320/6L2.2/5R/CB_bgn_0.3D_HG_SL11	AAM300	NLED15.6WXGAG	M92XT	512M-DDR3 (64*16*4)	SO2GBII6	N320GB5.4KS	NSM8XS	3rd WiFi 1x2 BGN	N	N	90W	0.3M DV	SLO/CRO (KB.I170A.049)	Continental
AS5542G-304G32Mn	EMEA	Czech	LX.PHP02.028	AS5542G-304G32Mn W7HP64ATCZ2 MC M92XT512Cbb_V3 2*2G/320/6L2.2/5R/CB_bgn_0.3D_HG_SK11	AAM300	NLED15.6WXGAG	M92XT	512M-DDR3 (64*16*4)	SO2GBII6	N320GB5.4KS	NSM8XS	3rd WiFi 1x2 BGN	N	N	90W	0.3M DV	CZ/SK (KB.I170A.035)	Continental
AS5542G-304G32Mn	EMEA	Austria	LX.PHP02.026	AS5542G-304G32Mn W7HP64ATAT1 MC M92XT512Cbb_V3 2*2G/320/6L2.2/5R/CB_bgn_0.3D_HG_DE61	AAM300	NLED15.6WXGAG	M92XT	512M-DDR3 (64*16*4)	SO2GBII6	N320GB5.4KS	NSM8XS	3rd WiFi 1x2 BGN	N	N	90W	0.3M DV	German (KB.I170A.040)	Continental
AS5542G-304G32Mn	EMEA	Eastern Europe	LX.PHP02.030	AS5542G-304G32Mn W7HP64ATEU5 MC M92XT512Cbb_V3 2*2G/320/6L2.2/5R/CB_bgn_0.3D_HG_PL11	AAM300	NLED15.6WXGAG	M92XT	512M-DDR3 (64*16*4)	SO2GBII6	N320GB5.4KS	NSM8XS	3rd WiFi 1x2 BGN	N	N	90W	0.3M DV	US International (KB.I170A.056)	Continental
AS5542G-304G32Mn	EMEA	Eastern Europe	LX.PHP02.029	AS5542G-304G32Mn W7HP64ATEU7 MC M92XT512Cbb_V3 2*2G/320/6L2.2/5R/CB_bgn_0.3D_HG_ENG1	AAM300	NLED15.6WXGAG	M92XT	512M-DDR3 (64*16*4)	SO2GBII6	N320GB5.4KS	NSM8XS	3rd WiFi 1x2 BGN	N	N	90W	0.3M DV	SLO/CRO (KB.I170A.049)	Continental
AS5542G-304G32Mn	EMEA	Sweden	LX.PHP02.027	AS5542G-304G32Mn W7HP64ATSE1 MC M92XT512Cbb_V3 2*2G/320/6L2.2/5R/CB_bgn_0.3D_HG_F111	AAM300	NLED15.6WXGAG	M92XT	512M-DDR3 (64*16*4)	SO2GBII6	N320GB5.4KS	NSM8XS	3rd WiFi 1x2 BGN	N	N	90W	0.3M DV	Sweden (KB.I170A.051)	Continental
AS5542G-304G32Mn	EMEA	Norway	LX.PHP02.025	AS5542G-304G32Mn W7HP64ATNO1 MC M92XT512Cbb_V3 2*2G/320/6L2.2/5R/CB_bgn_0.3D_HG_NO11	AAM300	NLED15.6WXGAG	M92XT	512M-DDR3 (64*16*4)	SO2GBII6	N320GB5.4KS	NSM8XS	3rd WiFi 1x2 BGN	N	N	90W	0.3M DV	Norwegian (KB.I170A.046)	Continental
AS5542G-304G32Mn	EMEA	Luxembourg	LX.PHP02.023	AS5542G-304G32Mn W7HP64ATLU3 MC M92XT512Cbb_V3 2*2G/320/6L2.2/5R/CB_bgn_0.3D_HG_IT41	AAM300	NLED15.6WXGAG	M92XT	512M-DDR3 (64*16*4)	SO2GBII6	N320GB5.4KS	NSM8XS	3rd WiFi 1x2 BGN	N	N	90W	0.3M DV	Swiss/G (KB.I170A.052)	Continental
AS5542G-304G32Mn	EMEA	Norway	LX.PHP02.024	AS5542G-304G32Mn W7HP64ATNO3 MC M92XT512Cbb_V3 2*2G/320/6L2.2/5R/CB_bgn_0.3D_HG_ENS1	AAM300	NLED15.6WXGAG	M92XT	512M-DDR3 (64*16*4)	SO2GBII6	N320GB5.4KS	NSM8XS	3rd WiFi 1x2 BGN	N	N	90W	0.3M DV	Nordic (KB.I170A.045)	Danish/Continental
AS5542G-304G32Mn	EMEA	Belgium	LX.PHP02.034	AS5542G-304G32Mn W7HP64ATBE1 MC M92XT512Cbb_V3 2*2G/320/6L2.2/5R/CB_bgn_0.3D_HG_NL11	AAM300	NLED15.6WXGAG	M92XT	512M-DDR3 (64*16*4)	SO2GBII6	N320GB5.4KS	NSM8XS	3rd WiFi 1x2 BGN	N	N	90W	0.3M DV	Belgium (KB.I170A.033)	Continental
AS5542G-304G32Mn	EMEA	Germany	LX.PHP02.033	AS5542G-304G32Mn W7HP64ATDE1 MC M92XT512Cbb_V3 2*2G/320/6L2.2/5R/CB_bgn_0.3D_HG_DE11	AAM300	NLED15.6WXGAG	M92XT	512M-DDR3 (64*16*4)	SO2GBII6	N320GB5.4KS	NSM8XS	3rd WiFi 1x2 BGN	N	N	90W	0.3M DV	German (KB.I170A.040)	Continental
AS5542G-304G32Mn	EMEA	Holland	LX.PHP02.022	AS5542G-304G32Mn W7HP64ATNL1 MC M92XT512Cbb_V3 2*2G/320/6L2.2/5R/CB_bgn_0.3D_HG_NL11	AAM300	NLED15.6WXGAG	M92XT	512M-DDR3 (64*16*4)	SO2GBII6	N320GB5.4KS	NSM8XS	3rd WiFi 1x2 BGN	N	N	90W	0.3M DV	US International (KB.I170A.056)	Continental
AS5542G-304G32Mn	EMEA	Denmark	LX.PHP02.032	AS5542G-304G32Mn W7HP64ATDK1 MC M92XT512Cbb_V3 2*2G/320/6L2.2/5R/CB_bgn_0.3D_HG_NO11	AAM300	NLED15.6WXGAG	M92XT	512M-DDR3 (64*16*4)	SO2GBII6	N320GB5.4KS	NSM8XS	3rd WiFi 1x2 BGN	N	N	90W	0.3M DV	Danish (KB.I170A.037)	Danish
AS5542G-304G32Mn	EMEA	Denmark	LX.PHP02.031	AS5542G-304G32Mn W7HP64ATDK2 MC M92XT512Cbb_V3 2*2G/320/6L2.2/5R/CB_bgn_0.3D_HG_ENS1	AAM300	NLED15.6WXGAG	M92XT	512M-DDR3 (64*16*4)	SO2GBII6	N320GB5.4KS	NSM8XS	3rd WiFi 1x2 BGN	N	N	90W	0.3M DV	Nordic (KB.I170A.045)	Danish/Continental
AS5542G-304G32MI	EMEA	Russia	LX.PHP02.004	AS5542G-304G32MI W7HP64RUATRU1 MC M92XT512Cbb_V3 2*2G/320/6L2.2/5R/CB_bg_0.3D_HG_RU11	AAM300	NLED15.6WXGAG	M92XT	512M-DDR3 (64*16*4)	SO2GBII6	N320GB5.4KS	NSM8XS	3rd WiFi BG	N	N	90W	0.3M DV	Russian (KB.I170A.048)	Continental

Model	RO	Country	Acer Part No	Description	CPU	LCD	VGA Chip	VRAM 1	Memory 1/ Memory 2	HDD 1 (GB)	ODD	Wireless LAN1	Bluetooth	Finger Print	Adapter	Camera	K/B	Power Cord
AS5542G-304G25Mn	EMEA	France	LX.PHP02.001	AS5542G-304G25Mn W7HP64ATFR1 MC M92XT512Cbb 2*2G/250/6L2.2/5R/ CB_bgn_0.3D_HG_FR21	AAM300	NLED15.6WXGAG	M92XT	512M-DDR3 (64*16*4)	SO2GBII6	N250GB5.4KS	NSM8XS	3rd WiFi 1x2 BGN	N	N	90W	0.3M DV	French (KB.I170A.039)	Continental
AS5542G-304G32Mn	EMEA	France	LX.PHP02.002	AS5542G-304G32Mn W7HP64ATFR1 MC M92XT512Cbb_V3 2*2G/320/6L2.2/5R/ CB_bgn_0.3D_HG_FR21	AAM300	NLED15.6WXGAG	M92XT	512M-DDR3 (64*16*4)	SO2GBII6	N320GB5.4KS	NSM8XS	3rd WiFi 1x2 BGN	N	N	90W	0.3M DV	French (KB.I170A.039)	Continental
AS5542G-504G32Mn	EMEA	UK	LX.PHP02.044	AS5542G-504G32Mn W7HP64ATGB1 MC M92XT512Cbb_V3 2*2G/320/6L2.2/5R/ CB_bgn_0.3D_HG_EN11	ATM500	NLED15.6WXGAG	M92XT	512M-DDR3 (64*16*4)	SO2GBII6	N320GB5.4KS	NSM8XS	3rd WiFi 1x2 BGN	N	N	90W	0.3M DV	UK (KB.I170A.055)	UK
AS5542G-643G32Bn	WW	GCTWN	S2.PHP0C.001	AS5542G-643G32Bn LNPUSAWW1 M92XT512Cbb_V3 2G+1G/320/6L2.2/5R/ CB_bgn_0.3D_HG_ENX1	ATUM640	NLED15.6WXGAG	M92XT	512M-DDR3 (64*16*4)	SO2GBII6	N320GB5.4KS	NBDCB4 XS	3rd WiFi 1x2 BGN	BT 2.1	N	90W	0.3M DV	US International (KB.I170A.056)	US and Continental
AS5542G-602G32Mn	AAP	Vietnam	LX.PHP0C.001	AS5542G-602G32Mn LNPUSAVN1 M92XT512Cbb_V3 1*2G/320/6L2.2/5R/ CB_bgn_0.3D_HG_EN11	ATUM600	NLED15.6WXGAG	M92XT	512M-DDR3 (64*16*4)	SO2GBII6/N	N320GB5.4KS	NSM8XS	3rd WiFi 1x2 BGN	BT 2.1	N	90W	0.3M DV	US International (KB.I170A.056)	Europe
AS5542G-302G25Mn	EMEA	Germany	LX.PHN02.001	AS5542G-302G25Mn W7HP64ATDE1 MC M92XT512bb_V3 1*2G/250/6L2.2/5R/ CB_bgn_HG_DE11	AAM300	NLED15.6WXGAG	M92XT	512M-DDR3 (64*16*4)	SO2GBII6/N	N250GB5.4KS	NSM8XS	3rd WiFi 1x2 BGN	N	N	90W	N	German (KB.I170A.040)	Continental
AS5542G-643G32Bn	WW	GCTWN	S2.PHN0C.001	AS5542G-643G32Bn LNPUSAWW1 M92XT512bb 2G+1G/320/6L2.2/5R/ CB_bgn_HG_ENX1	ATUM640	NLED15.6WXGAG	M92XT	512M-DDR3 (64*16*4)	SO2GBII6	N320GB5.4KS	NBDCB4 XS	3rd WiFi 1x2 BGN	BT 2.1	N	90W	N	US International (KB.I170A.056)	US and Continental
AS5542-303G32Mn	AAP	India	LX.PHB02.007	AS5542-303G32Mn W7HP64INATIN1 MC UMACFbb 2G+1G/320/6L2.2/5R/ CB_bgn_FP_0.3D_HG_ES61	AAM300	NLED15.6WXGAG	UMA	N	SO2GBII6	N320GB5.4KS	NSM8XS	3rd WiFi 1x2 BGN	BT 2.1	AES1610	65W	0.3M DV	US International (KB.I170A.056)	South Africa-S (India)
AS5542-303G32Mn	AAP	India	LX.PHB01.003	AS5542-303G32Mn W7HB64INATIN1 MC UMACFbb 2G+1G/320/6L2.2/5R/ CB_bgn_FP_0.3D_HG_ES61	AAM300	NLED15.6WXGAG	UMA	N	SO2GBII6	N320GB5.4KS	NSM8XS	3rd WiFi 1x2 BGN	BT 2.1	AES1610	65W	0.3M DV	US International (KB.I170A.056)	South Africa-S (India)
AS5542-302G32Mn	AAP	India	LX.PHB01.001	AS5542-302G32Mn W7HB64INATIN1 MC UMACFbb 1*2G/320/6L2.2/5R/ CB_bgn_FP_0.3D_HG_ES61	AAM300	NLED15.6WXGAG	UMA	N	SO2GBII6/N	N320GB5.4KS	NSM8XS	3rd WiFi 1x2 BGN	BT 2.1	AES1610	65W	0.3M DV	US International (KB.I170A.056)	South Africa-S (India)
AS5542-302G32Mn	AAP	India	LX.PHB0C.001	AS5542-302G32Mn LNPUSAIN1 UMACFbb 1*2G/320/6L2.2/5R/ CB_bgn_FP_0.3D_HG_EN11	AAM300	NLED15.6WXGAG	UMA	N	SO2GBII6/N	N320GB5.4KS	NSM8XS	3rd WiFi 1x2 BGN	BT 2.1	AES1610	65W	0.3M DV	US International (KB.I170A.056)	South Africa-S (India)
AS5542-302G32Mn	AAP	India	LX.PHB02.006	AS5542-302G32Mn W7HP64INATIN1 MC UMACFbb 1*2G/320/6L2.2/5R/ CB_bgn_FP_0.3D_HG_ES61	AAM300	NLED15.6WXGAG	UMA	N	SO2GBII6/N	N320GB5.4KS	NSM8XS	3rd WiFi 1x2 BGN	BT 2.1	AES1610	65W	0.3M DV	US International (KB.I170A.056)	South Africa-S (India)
AS5542-324G32Mn	AAP	Australia/ New Zealand	LX.PHB02.004	AS5542-324G32Mn W7HP64ATAU1 MC UMACFbb 2*2G/320/6L2.2/5R/ CB_bgn_FP_0.3D_HG_ES61	AAM320	NLED15.6WXGAG	UMA	N	SO2GBII6	N320GB5.4KS	NSM8XS	3rd WiFi 1x2 BGN	N	AES1610	65W	0.3M DV	US International (KB.I170A.056)	Australia w/ label
AS5542-324G50Mn	AAP	Australia/ New Zealand	LX.PHB02.003	AS5542-324G50Mn W7HP64ATAU1 MC UMACFbb 2*2G/500_L/6L2.2/5R/ CB_bgn_FP_0.3D_HG_ES61	AAM320	NLED15.6WXGAG	UMA	N	SO2GBII6	N500GB5.4KS	NSM8XS	3rd WiFi 1x2 BGN	N	AES1610	65W	0.3M DV	US International (KB.I170A.056)	Australia w/ label
AS5542-304G32Mn	AAP	Australia/ New Zealand	LX.PHB02.002	AS5542-304G32Mn W7HP64ATAU1 MC UMACFbb 2*2G/320/6L2.2/5R/ CB_bgn_FP_0.3D_HG_ES61	AAM300	NLED15.6WXGAG	UMA	N	SO2GBII6	N320GB5.4KS	NSM8XS	3rd WiFi 1x2 BGN	N	AES1610	65W	0.3M DV	US International (KB.I170A.056)	Australia w/ label
AS5542-304G32Mn	AAP	Japan	LX.PHB02.001	AS5542-304G32Mn W7HP64AJP1 MC UMACFbb 2*2G/320/6L2.2/5R/ CB_bgn_FP_0.3D_HG_JA11_MF43	AAM300	NLED15.6WXGAG	UMA	N	SO2GBII6	N320GB5.4KS	NSM8XS	3rd WiFi 1x2 BGN	BT 2.1	AES1610	65W	0.3M DV	Japanese (KB.I170A.044)	Japanese power cord
AS5542-522G16Mn	WW	GCTWN	S2.PHB02.001	AS5542-522G16Mn W7HP64AWW1 MC UMACFbb 2*1G/160/6L2.2/5R/ CB_bgn_FP_0.3D_HG_ES61	ATM520	NLED15.6WXGAG	UMA	N	SO1GBII6	N160GB5.4KS	NSM8XS	3rd WiFi 1x2 BGN	BT 2.1	AES1610	65W	0.3M DV	US International (KB.I170A.056)	US and Continental
AS5542-624G32Mn	WW	GCTWN	S2.PHB0C.001	AS5542-624G32Mn LNPUSAWW1 UMACFbb 2*2G/320/6L2.2/5R/ CB_bgn_FP_0.3D_HG_ENX1	ATUM620	NLED15.6WXGAG	UMA	N	SO2GBII6	N320GB5.4KS	NSM8XS	3rd WiFi 1x2 BGN	BT 2.1	AES1610	65W	0.3M DV	US International (KB.I170A.056)	US and Continental
AS5542-302G25Mn	EMEA	UK	LX.PHA02.102	AS5542-302G25Mn W7HP64ATGB1 MC UMACbb 1*2G/250/6L2.2/5R/ CB_bgn_0.3D_HG_EN11	AAM300	NLED15.6WXGAG	UMA	N	SO2GBII6/N	N250GB5.4KS	NSM8XS	3rd WiFi 1x2 BGN	N	N	65W	0.3M DV	UK (KB.I170A.055)	UK
AS5542-304G64Mn	EMEA	UK	LX.PHA02.101	AS5542-304G64Mn W7HP64ATGB1 MC UMACbb 2*2G/640/6L2.2/5R/ CB_bgn_0.3D_HG_EN11	AAM300	NLED15.6WXGAG	UMA	N	SO2GBII6	N640GB5.4KS	NSM8XS	3rd WiFi 1x2 BGN	N	N	65W	0.3M DV	UK (KB.I170A.055)	UK

Model	RO	Country	Acer Part No	Description	CPU	LCD	VGA Chip	VRAM 1	Memory 1/ Memory 2	HDD 1 (GB)	ODD	Wireless LAN1	Bluetooth	Finger Print	Adapter	Camera	K/B	Power Cord
AS5542-504G50Mn	PA	ACLA-Spanish	LX.PHA0C.027	AS5542-504G50Mn LNPUSAE3 UMACbb 2*2G/500_L/6L2.2/5R/ CB_bgn_0_3D_HG_EN61	ATM500	NLED15.6WXGAG	UMA	N	SO2GBII6	N500GB5.4KS	NSM8XS	3rd WiFi 1x2 BGN	N	N	65W	0.3M DV	Spanish (KB.I170A.050)	Argentine Power Cord
AS5542-504G32Mn	PA	ACLA-Spanish	LX.PHA02.010	AS5542-504G32Mn EM W7HP64EMATEA3 MC UMACbb 2*2G/320/6L2.2/5R/ CB_bgn_0_3D_HG_ES51	ATM500	NLED15.6WXGAG	UMA	N	SO2GBII6	N320GB5.4KS	NSM8XS	3rd WiFi 1x2 BGN	N	N	65W	0.3M DV	Spanish (KB.I170A.050)	Argentine Power Cord
AS5542-304G32Mn	AAP	Australia/ New Zealand	LX.PHA02.015	AS5542-304G32Mn W7HP64ATAU1 MC UMACbb 2*2G/320/6L2.2/5R/ CB_bgn_0_3D_HG_ES61	AAM300	NLED15.6WXGAG	UMA	N	SO2GBII6	N320GB5.4KS	NSM8XS	3rd WiFi 1x2 BGN	N	N	65W	0.3M DV	US International (KB.I170A.056)	Australia w/ label
AS5542-502G32Mn	CHINA	China	LX.PHA0C.010	AS5542-502G32Mn LNPUSACN1 UMACbb 1*2G/320/BT/6L2.2/5R/ CB_bgn_0_3D_HG_EN91	ATM500	NLED15.6WXGAG	UMA	N	SO2GBII6/N	N320GB5.4KS	NSM8XS	3rd WiFi 1x2 BGN	BT 2.1	N	65W	0.3M DV	US International (KB.I170A.056)	PRC
AS5542-303G25Mn	EMEA	Czech	LX.PHA02.055	AS5542-303G25Mn W7HP64ATC22 MC UMACbb 2G+1G/250/BT/6L2.2/5R/ CB_bgn_0_3D_HG_SK11	AAM300	NLED15.6WXGAG	UMA	N	SO2GBII6	N250GB5.4KS	NSM8XS	3rd WiFi 1x2 BGN	BT 2.1	N	65W	0.3M DV	CZ/SK (KB.I170A.035)	Continental
AS5542-301G16Mn	EMEA	South Africa	LX.PHA01.002	AS5542-301G16Mn EM W7HB64EMATZ44 MC UMACbb 1*1G/160/6L2.2/5R/ CB_bgn_0_3D_HG_ES61	AAM300	NLED15.6WXGAG	UMA	N	SO1GBII6/N	N160GB5.4KS	NSM8XS	3rd WiFi 1x2 BGN	N	N	65W	0.3M DV	US International (KB.I170A.056)	UK
AS5542-302G25Mn	EMEA	Czech	LX.PHA02.053	AS5542-302G25Mn W7HP64ATC22 MC UMACbb 1*2G/250/6L2.2/5R/ CB_bgn_0_3D_HG_SK11	AAM300	NLED15.6WXGAG	UMA	N	SO2GBII6/N	N250GB5.4KS	NSM8XS	3rd WiFi 1x2 BGN	N	N	65W	0.3M DV	CZ/SK (KB.I170A.035)	Continental
AS5542-504G64Mn	EMEA	UK	LX.PHA02.098	AS5542-504G64Mn W7HP64ATGB1 MC UMACbb 2*2G/640/6L2.2/5R/ CB_bgn_0_3D_HG_EN11	ATM500	NLED15.6WXGAG	UMA	N	SO2GBII6	N640GB5.4KS	NSM8XS	3rd WiFi 1x2 BGN	N	N	65W	0.3M DV	UK (KB.I170A.055)	UK
AS5542-304G50Mn	EMEA	Belgium	LX.PHA02.037	AS5542-304G50Mn W7HP64ATBE1 MC UMACbb 2*2G/500_L/6L2.2/5R/ CB_bgn_0_3D_HG_NL11	AAM300	NLED15.6WXGAG	UMA	N	SO2GBII6	N500GB5.4KS	NSM8XS	3rd WiFi 1x2 BGN	N	N	65W	0.3M DV	Belgium (KB.I170A.033)	Continental
AS5542-304G50Mn	EMEA	Czech	LX.PHA02.034	AS5542-304G50Mn W7HP64ATC22 MC UMACbb 2*2G/500_L/BT/6L2.2/5R/ CB_bgn_0_3D_HG_SK11	AAM300	NLED15.6WXGAG	UMA	N	SO2GBII6	N500GB5.4KS	NSM8XS	3rd WiFi 1x2 BGN	BT 2.1	N	65W	0.3M DV	CZ/SK (KB.I170A.035)	Continental
AS5542-304G50Mn	EMEA	Holland	LX.PHA02.036	AS5542-304G50Mn W7HP64ATN1 MC UMACbb 2*2G/500_L/6L2.2/5R/ CB_bgn_0_3D_HG_NL11	AAM300	NLED15.6WXGAG	UMA	N	SO2GBII6	N500GB5.4KS	NSM8XS	3rd WiFi 1x2 BGN	N	N	65W	0.3M DV	US International (KB.I170A.056)	Continental
AS5542-304G25Mn	AAP	Australia/ New Zealand	LX.PHA02.056	AS5542-304G25Mn W7HP64ATAU1 MC UMACbb 2*2G/250/6L2.2/5R/ CB_bgn_0_3D_HG_ES61	AAM300	NLED15.6WXGAG	UMA	N	SO2GBII6	N250GB5.4KS	NSM8XS	3rd WiFi 1x2 BGN	N	N	65W	0.3M DV	US International (KB.I170A.056)	Australia w/ label
AS5542-303G32Mn	PA	ACLA-Portuguese	LX.PHA0C.024	AS5542-303G32Mn LNPUSAXC3 UMACbb 2G+1G/320/6L2.2/5R/ CB_bgn_0_3D_HG_EN61	AAM300	NLED15.6WXGAG	UMA	N	SO2GBII6	N320GB5.4KS	NSM8XS	3rd WiFi 1x2 BGN	N	N	65W	0.3M DV	US International (KB.I170A.056)	Brazil IMETRO
AS5542-302G25Mn	AAP	Japan	LX.PHA02.099	AS5542-302G25Mn W7HP64APJ1 MC UMACbb 1*2G/250/6L2.2/5R/ CB_bgn_0_3D_HG_JA11_C22F	AAM300	NLED15.6WXGAG	UMA	N	SO2GBII6/N	N250GB5.4KS	NSM8XS	3rd WiFi 1x2 BGN	N	N	65W	0.3M DV	Japanese (KB.I170A.044)	Japanese power cord
AS5542-304G32Mn	PA	USA	LX.PHA02.058	AS5542-304G32Mn W7HP64ATU1 MC UMACbb 2*2G/320/6L2.2/5R/ CB_bgn_0_3D_HG_FRB1	AAM300	NLED15.6WXGAG	UMA	N	SO2GBII6	N320GB5.4KS	NSM8XS	3rd WiFi 1x2 BGN	N	N	65W	0.3M DV	US International (KB.I170A.056)	US-110V
AS5542-504G50Mn	PA	ACLA-Portuguese	LX.PHA0C.020	AS5542-504G50Mn LNPUSAXC3 UMACbb 2*2G/500_L/6L2.2/5R/ CB_bgn_0_3D_HG_EN61	ATM500	NLED15.6WXGAG	UMA	N	SO2GBII6	N500GB5.4KS	NSM8XS	3rd WiFi 1x2 BGN	N	N	65W	0.3M DV	US International (KB.I170A.056)	Brazil IMETRO
AS5542-504G50Bn	PA	ACLA-Portuguese	LX.PHA0C.003	AS5542-504G50Bn LNPUSAXC3 UMACbb 2*2G/500_L/6L2.2/5R/ CB_bgn_0_3D_HG_EN61	ATM500	NLED15.6WXGAG	UMA	N	SO2GBII6	N500GB5.4KS	NBDCB4 XS	3rd WiFi 1x2 BGN	N	N	65W	0.3M DV	US International (KB.I170A.056)	Brazil IMETRO
AS5542-504G50Mn	EMEA	Czech	LX.PHA02.033	AS5542-504G50Mn W7HP64ATC22 MC UMACbb 2*2G/500_L/BT/6L2.2/5R/ CB_bgn_0_3D_HG_SK11	ATM500	NLED15.6WXGAG	UMA	N	SO2GBII6	N500GB5.4KS	NSM8XS	3rd WiFi 1x2 BGN	BT 2.1	N	65W	0.3M DV	CZ/SK (KB.I170A.035)	Continental
AS5542-303G32Mn	PA	ACLA-Spanish	LX.PHA0C.034	AS5542-303G32Mn LNPUSAE4 UMACbb 2G+1G/320/6L2.2/5R/ CB_bgn_0_3D_HG_EN62	AAM300	NLED15.6WXGAG	UMA	N	SO2GBII6	N320GB5.4KS	NSM8XS	3rd WiFi 1x2 BGN	N	N	65W	0.3M DV	US International (KB.I170A.056)	US-110V
AS5542-303G32Mn	PA	ACLA-Spanish	LX.PHA0C.032	AS5542-303G32Mn LNPUSAE1 UMACbb 2G+1G/320/6L2.2/5R/ CB_bgn_0_3D_HG_EN62	AAM300	NLED15.6WXGAG	UMA	N	SO2GBII6	N320GB5.4KS	NSM8XS	3rd WiFi 1x2 BGN	N	N	65W	0.3M DV	Spanish (KB.I170A.050)	US-110V



Model	RO	Country	Acer Part No	Description	CPU	LCD	VGA Chip	VRAM 1	Memory 1/ Memory 2	HDD 1 (GB)	ODD	Wireless LAN1	Bluetooth	Finger Print	Adapter	Camera	K/B	Power Cord
AS5542-303G32Mn	PA	Chile	LX.PHA0C.033	AS5542-303G32Mn LNPUSACL3 UMACbb 2G+1G/320/6L2.2/5R/ CB_bgn_0.3D_HG_EN61	AAM300	NLED15.6WXGAG	UMA	N	SO2GBII6	N320GB5.4KS	NSM8XS	3rd WiFi 1x2 BGN	N	N	65W	0.3M DV	Spanish (KB.I170A.050)	Italian
AS5542-303G32Mn	PA	ACLA-Spanish	LX.PHA0C.031	AS5542-303G32Mn LNPUSAE3 UMACbb 2G+1G/320/6L2.2/5R/ CB_bgn_0.3D_HG_EN61	AAM300	NLED15.6WXGAG	UMA	N	SO2GBII6	N320GB5.4KS	NSM8XS	3rd WiFi 1x2 BGN	N	N	65W	0.3M DV	Spanish (KB.I170A.050)	Argentine Power Cord
AS5542-504G50Mn	PA	Chile	LX.PHA0C.030	AS5542-504G50Mn LNPUSACL3 UMACbb 2*2G/500_L/6L2.2/5R/ CB_bgn_0.3D_HG_EN61	ATM500	NLED15.6WXGAG	UMA	N	SO2GBII6	N500GB5.4KS	NSM8XS	3rd WiFi 1x2 BGN	N	N	65W	0.3M DV	Spanish (KB.I170A.050)	Italian
AS5542-504G50Mn	PA	ACLA-Spanish	LX.PHA0C.029	AS5542-504G50Mn LNPUSAE4 UMACbb 2*2G/500_L/6L2.2/5R/ CB_bgn_0.3D_HG_EN62	ATM500	NLED15.6WXGAG	UMA	N	SO2GBII6	N500GB5.4KS	NSM8XS	3rd WiFi 1x2 BGN	N	N	65W	0.3M DV	US International (KB.I170A.056)	US-110V
AS5542-504G50Mn	PA	ACLA-Spanish	LX.PHA0C.028	AS5542-504G50Mn LNPUSAE1 UMACbb 2*2G/500_L/6L2.2/5R/ CB_bgn_0.3D_HG_EN62	ATM500	NLED15.6WXGAG	UMA	N	SO2GBII6	N500GB5.4KS	NSM8XS	3rd WiFi 1x2 BGN	N	N	65W	0.3M DV	Spanish (KB.I170A.050)	US-110V
AS5542-303G32Mn	EMEA	Eastern Europe	LX.PHA0C.014	AS5542-303G32Mn LNPUSAEU5 UMACbb 2G+1G/320/6L2.2/5R/ CB_bgn_0.3D_HG_ENF1	AAM300	NLED15.6WXGAG	UMA	N	SO2GBII6	N320GB5.4KS	NSM8XS	3rd WiFi 1x2 BGN	N	N	65W	0.3M DV	US International (KB.I170A.056)	Continental
AS5542-304G32Mi	EMEA	Russia	LX.PHA02.097	AS5542-304G32Mi W7HP64RUATR1 MC UMACbb 2*2G/320/6L2.2/5R/ CB_bg_0.3D_HG_RU11	AAM300	NLED15.6WXGAG	UMA	N	SO2GBII6	N320GB5.4KS	NSM8XS	3rd WiFi BG	N	N	65W	0.3M DV	Russian (KB.I170A.048)	Continental
AS5542-304G32Mn	EMEA	Ukraine	LX.PHA02.096	AS5542-304G32Mn W7HP64RUATUK1 MC UMACbb 2*2G/320/6L2.2/5R/ CB_bgn_0.3D_HG_RU61	AAM300	NLED15.6WXGAG	UMA	N	SO2GBII6	N320GB5.4KS	NSM8XS	3rd WiFi 1x2 BGN	N	N	65W	0.3M DV	Russian (KB.I170A.048)	Continental
AS5542-304G32Mn	EMEA	Middle East	LX.PHA02.095	AS5542-304G32Mn EM W7HP64EMATME9 MC UMACbb 2*2G/ 320/6L2.2/5R/CB_bgn_0.3D_HG_ES81	AAM300	NLED15.6WXGAG	UMA	N	SO2GBII6	N320GB5.4KS	NSM8XS	3rd WiFi 1x2 BGN	N	N	65W	0.3M DV	FR/Arabic (KB.I170A.038)	Continental
AS5542-304G32Mn	EMEA	South Africa	LX.PHA02.094	AS5542-304G32Mn EM W7HP64EMATZA1 MC UMACbb 2*2G/ 320/6L2.2/5R/CB_bgn_0.3D_HG_ES81	AAM300	NLED15.6WXGAG	UMA	N	SO2GBII6	N320GB5.4KS	NSM8XS	3rd WiFi 1x2 BGN	N	N	65W	0.3M DV	French (KB.I170A.039)	Continental
AS5542-304G32Mn	EMEA	Middle East	LX.PHA02.093	AS5542-304G32Mn EM W7HP64EMATME2 MC UMACbb 2*2G/ 320/6L2.2/5R/CB_bgn_0.3D_HG_ES61	AAM300	NLED15.6WXGAG	UMA	N	SO2GBII6	N320GB5.4KS	NSM8XS	3rd WiFi 1x2 BGN	N	N	65W	0.3M DV	Arabic (KB.I170A.032)	UK and US- 110V
AS5542-304G32Mn	EMEA	South Africa	LX.PHA02.092	AS5542-304G32Mn EM W7HP64EMATZA4 MC UMACbb 2*2G/ 320/6L2.2/5R/CB_bgn_0.3D_HG_ES61	AAM300	NLED15.6WXGAG	UMA	N	SO2GBII6	N320GB5.4KS	NSM8XS	3rd WiFi 1x2 BGN	N	N	65W	0.3M DV	US International (KB.I170A.056)	UK
AS5542-304G32Mn	EMEA	Turkey	LX.PHA02.091	AS5542-304G32Mn EM W7HP64EMATTR1 MC UMACbb 2*2G/ 320/6L2.2/5R/CB_bgn_0.3D_HG_TR31	AAM300	NLED15.6WXGAG	UMA	N	SO2GBII6	N320GB5.4KS	NSM8XS	3rd WiFi 1x2 BGN	N	N	65W	0.3M DV	Turkish (KB.I170A.054)	Continental
AS5542-304G32Mn	EMEA	South Africa	LX.PHA02.090	AS5542-304G32Mn EM W7HP64EMATZA2 MC UMACbb 2*2G/ 320/6L2.2/5R/CB_bgn_0.3D_HG_ES61	AAM300	NLED15.6WXGAG	UMA	N	SO2GBII6	N320GB5.4KS	NSM8XS	3rd WiFi 1x2 BGN	N	N	65W	0.3M DV	US International (KB.I170A.056)	AF
AS5542-304G32Mn	EMEA	Middle East	LX.PHA02.089	AS5542-304G32Mn EM W7HP64EMATME9 MC UMACbb 2*2G/ 320/6L2.2/5R/CB_bgn_0.3D_HG_ES61	AAM300	NLED15.6WXGAG	UMA	N	SO2GBII6	N320GB5.4KS	NSM8XS	3rd WiFi 1x2 BGN	N	N	65W	0.3M DV	US International (KB.I170A.056)	UK
AS5542-304G32Mn	EMEA	Middle East	LX.PHA02.088	AS5542-304G32Mn EM W7HP64EMATME2 MC UMACbb 2*2G/ 320/6L2.2/5R/CB_bgn_0.3D_HG_AR21	AAM300	NLED15.6WXGAG	UMA	N	SO2GBII6	N320GB5.4KS	NSM8XS	3rd WiFi 1x2 BGN	N	N	65W	0.3M DV	Arabic (KB.I170A.032)	UK and US- 110V
AS5542-304G32Mn	EMEA	Middle East	LX.PHA02.087	AS5542-304G32Mn EM W7HP64EMATME2 MC UMACbb 2*2G/ 320/6L2.2/5R/CB_bgn_0.3D_HG_AR11	AAM300	NLED15.6WXGAG	UMA	N	SO2GBII6	N320GB5.4KS	NSM8XS	3rd WiFi 1x2 BGN	N	N	65W	0.3M DV	Arabic (KB.I170A.032)	UK and US- 110V
AS5542-304G32Mn	EMEA	Algeria	LX.PHA02.085	AS5542-304G32Mn EM W7HP64EMATD21 MC UMACbb 2*2G/ 320/6L2.2/5R/CB_bgn_0.3D_HG_ES81	AAM300	NLED15.6WXGAG	UMA	N	SO2GBII6	N320GB5.4KS	NSM8XS	3rd WiFi 1x2 BGN	N	N	65W	0.3M DV	FR/Arabic (KB.I170A.038)	Continental
AS5542-304G32Mn	EMEA	Middle East	LX.PHA02.086	AS5542-304G32Mn EM W7HP64EMATME4 MC UMACbb 2*2G/ 320/6L2.2/5R/CB_bgn_0.3D_HG_ES61	AAM300	NLED15.6WXGAG	UMA	N	SO2GBII6	N320GB5.4KS	NSM8XS	3rd WiFi 1x2 BGN	N	N	65W	0.3M DV	Russian (KB.I170A.048)	Continental
AS5542-304G32Mn	EMEA	Middle East	LX.PHA02.084	AS5542-304G32Mn EM W7HP64EMATME4 MC UMACbb 2*2G/ 320/6L2.2/5R/CB_bgn_0.3D_HG_RU61	AAM300	NLED15.6WXGAG	UMA	N	SO2GBII6	N320GB5.4KS	NSM8XS	3rd WiFi 1x2 BGN	N	N	65W	0.3M DV	Russian (KB.I170A.048)	Continental

Model	RO	Country	Acer Part No	Description	CPU	LCD	VGA Chip	VRAM 1	Memory 1/ Memory 2	HDD 1 (GB)	ODD	Wireless LAN1	Bluetooth	Finger Print	Adapter	Camera	K/B	Power Cord
AS5542-304G32Mn	EMEA	Middle East	LX.PHA02.083	AS5542-304G32Mn EM W7HP64EMATME3 MC UMACbb 2*2G/320/6L2.2/5R/CB_bgn_0.3D_HG_ES81	AAM300	NLED15.6WXGAG	UMA	N	SO2GBIIE	N320GB5.4KS	NSM8XS	3rd WiFi 1x2 BGN	N	N	65W	0.3M DV	French (KB.I170A.039)	Continental
AS5542-304G32Mn	EMEA	Belgium	LX.PHA02.082	AS5542-304G32Mn W7HP64ATEB1 MC UMACbb 2*2G/320/6L2.2/5R/CB_bgn_0.3D_HG_NL11	AAM300	NLED15.6WXGAG	UMA	N	SO2GBIIE	N320GB5.4KS	NSM8XS	3rd WiFi 1x2 BGN	N	N	65W	0.3M DV	Belgium (KB.I170A.033)	Continental
AS5542-304G32Mn	EMEA	Germany	LX.PHA02.081	AS5542-304G32Mn W7HP64ATDE1 MC UMACbb 2*2G/320/6L2.2/5R/CB_bgn_0.3D_HG_DE11	AAM300	NLED15.6WXGAG	UMA	N	SO2GBIIE	N320GB5.4KS	NSM8XS	3rd WiFi 1x2 BGN	N	N	65W	0.3M DV	German (KB.I170A.040)	Continental
AS5542-304G32Mn	EMEA	Eastern Europe	LX.PHA02.080	AS5542-304G32Mn W7HP64ATEU5 MC UMACbb 2*2G/320/6L2.2/5R/CB_bgn_0.3D_HG_RO11	AAM300	NLED15.6WXGAG	UMA	N	SO2GBIIE	N320GB5.4KS	NSM8XS	3rd WiFi 1x2 BGN	N	N	65W	0.3M DV	US International (KB.I170A.056)	Continental
AS5542-304G32Mn	EMEA	Hungary	LX.PHA02.079	AS5542-304G32Mn W7HP64ATHU1 MC UMACbb 2*2G/320/6L2.2/5R/CB_bgn_0.3D_HG_HU11	AAM300	NLED15.6WXGAG	UMA	N	SO2GBIIE	N320GB5.4KS	NSM8XS	3rd WiFi 1x2 BGN	N	N	65W	0.3M DV	Hungarian (KB.I170A.042)	Continental
AS5542-304G32Mn	EMEA	Israel	LX.PHA02.078	AS5542-304G32Mn W7HP64ATIL1 MC UMACbb 2*2G/320/6L2.2/5R/CB_bgn_0.3D_HG_HE11	AAM300	NLED15.6WXGAG	UMA	N	SO2GBIIE	N320GB5.4KS	NSM8XS	3rd WiFi 1x2 BGN	N	N	65W	0.3M DV	US International w/ Hebrew (KB.I170A.057)	Israel
AS5542-304G32Mn	EMEA	Spain	LX.PHA02.077	AS5542-304G32Mn W7HP64ATES1 MC UMACbb 2*2G/320/6L2.2/5R/CB_bgn_0.3D_HG_ES51	AAM300	NLED15.6WXGAG	UMA	N	SO2GBIIE	N320GB5.4KS	NSM8XS	3rd WiFi 1x2 BGN	N	N	65W	0.3M DV	Spanish (KB.I170A.050)	Continental
AS5542-304G32Mn	EMEA	Portugal	LX.PHA02.076	AS5542-304G32Mn W7HP64ATPT1 MC UMACbb 2*2G/320/6L2.2/5R/CB_bgn_0.3D_HG_PT11	AAM300	NLED15.6WXGAG	UMA	N	SO2GBIIE	N320GB5.4KS	NSM8XS	3rd WiFi 1x2 BGN	N	N	65W	0.3M DV	Portuguese (KB.I170A.047)	Continental
AS5542-304G32Mn	EMEA	France	LX.PHA02.075	AS5542-304G32Mn W7HP64ATFR1 MC UMACbb 2*2G/320/6L2.2/5R/CB_bgn_0.3D_HG_FR21	AAM300	NLED15.6WXGAG	UMA	N	SO2GBIIE	N320GB5.4KS	NSM8XS	3rd WiFi 1x2 BGN	N	N	65W	0.3M DV	French (KB.I170A.039)	Continental
AS5542-304G32Mn	EMEA	Italy	LX.PHA02.074	AS5542-304G32Mn W7HP64ATIT1 MC UMACbb 2*2G/320/6L2.2/5R/CB_bgn_0.3D_HG_IT11	AAM300	NLED15.6WXGAG	UMA	N	SO2GBIIE	N320GB5.4KS	NSM8XS	3rd WiFi 1x2 BGN	N	N	65W	0.3M DV	Italian (KB.I170A.043)	Italian
AS5542-304G32Mn	EMEA	Austria	LX.PHA02.073	AS5542-304G32Mn W7HP64ATAT1 MC UMACbb 2*2G/320/6L2.2/5R/CB_bgn_0.3D_HG_DE61	AAM300	NLED15.6WXGAG	UMA	N	SO2GBIIE	N320GB5.4KS	NSM8XS	3rd WiFi 1x2 BGN	N	N	65W	0.3M DV	German (KB.I170A.040)	Continental
AS5542-304G32Mn	EMEA	Latvia	LX.PHA02.072	AS5542-304G32Mn W7HP64ATLV1 MC UMACbb 2*2G/320/6L2.2/5R/CB_bgn_0.3D_HG_RU22	AAM300	NLED15.6WXGAG	UMA	N	SO2GBIIE	N320GB5.4KS	NSM8XS	3rd WiFi 1x2 BGN	N	N	65W	0.3M DV	Russian (KB.I170A.048)	Continental
AS5542-304G32Mn	EMEA	Eastern Europe	LX.PHA02.070	AS5542-304G32Mn W7HP64ATEU7 MC UMACbb 2*2G/320/6L2.2/5R/CB_bgn_0.3D_HG_ENQ1	AAM300	NLED15.6WXGAG	UMA	N	SO2GBIIE	N320GB5.4KS	NSM8XS	3rd WiFi 1x2 BGN	N	N	65W	0.3M DV	SLO/CRO (KB.I170A.049)	Continental
AS5542-304G32Mn	EMEA	Holland	LX.PHA02.071	AS5542-304G32Mn W7HP64ATNL1 MC UMACbb 2*2G/320/6L2.2/5R/CB_bgn_0.3D_HG_NL11	AAM300	NLED15.6WXGAG	UMA	N	SO2GBIIE	N320GB5.4KS	NSM8XS	3rd WiFi 1x2 BGN	N	N	65W	0.3M DV	US International (KB.I170A.056)	Continental
AS5542-304G32Mn	EMEA	Czech	LX.PHA02.069	AS5542-304G32Mn W7HP64ATCZ2 MC UMACbb 2*2G/320/6L2.2/5R/CB_bgn_0.3D_HG_SK11	AAM300	NLED15.6WXGAG	UMA	N	SO2GBIIE	N320GB5.4KS	NSM8XS	3rd WiFi 1x2 BGN	N	N	65W	0.3M DV	CZ/SK (KB.I170A.035)	Continental
AS5542-304G32Mn	EMEA	Denmark	LX.PHA02.068	AS5542-304G32Mn W7HP64ATDK2 MC UMACbb 2*2G/320/6L2.2/5R/CB_bgn_0.3D_HG_ENS1	AAM300	NLED15.6WXGAG	UMA	N	SO2GBIIE	N320GB5.4KS	NSM8XS	3rd WiFi 1x2 BGN	N	N	65W	0.3M DV	Nordic (KB.I170A.045)	Danish/Continental
AS5542-304G32Mn	EMEA	Cyprus	LX.PHA02.067	AS5542-304G32Mn W7HP64ATCY1 MC UMACbb 2*2G/320/6L2.2/5R/CB_bgn_0.3D_HG_ES61	AAM300	NLED15.6WXGAG	UMA	N	SO2GBIIE	N320GB5.4KS	NSM8XS	3rd WiFi 1x2 BGN	N	N	65W	0.3M DV	UK (KB.I170A.055)	UK
AS5542-304G32Mn	EMEA	Eastern Europe	LX.PHA02.066	AS5542-304G32Mn W7HP64ATEU5 MC UMACbb 2*2G/320/6L2.2/5R/CB_bgn_0.3D_HG_PL71	AAM300	NLED15.6WXGAG	UMA	N	SO2GBIIE	N320GB5.4KS	NSM8XS	3rd WiFi 1x2 BGN	N	N	65W	0.3M DV	US International (KB.I170A.056)	Continental
AS5542-304G32Mn	EMEA	Eastern Europe	LX.PHA02.065	AS5542-304G32Mn W7HP64ATEU4 MC UMACbb 2*2G/320/6L2.2/5R/CB_bgn_0.3D_HG_SV21	AAM300	NLED15.6WXGAG	UMA	N	SO2GBIIE	N320GB5.4KS	NSM8XS	3rd WiFi 1x2 BGN	N	N	65W	0.3M DV	Sweden (KB.I170A.051)	Continental
AS5542-304G32Mn	EMEA	Poland	LX.PHA02.064	AS5542-304G32Mn W7HP64ATPL1 MC UMACbb 2*2G/320/6L2.2/5R/CB_bgn_0.3D_HG_PL11	AAM300	NLED15.6WXGAG	UMA	N	SO2GBIIE	N320GB5.4KS	NSM8XS	3rd WiFi 1x2 BGN	N	N	65W	0.3M DV	US International (KB.I170A.056)	Continental

Model	RO	Country	Acer Part No	Description	CPU	LCD	VGA Chip	VRAM 1	Memory 1/ Memory 2	HDD 1 (GB)	ODD	Wireless LAN1	Bluetooth	Finger Print	Adapter	Camera	K/B	Power Cord
AS5542-304G32Mn	EMEA	Greece	LX.PHA02.063	AS5542-304G32Mn W7HP64ATGR1 MC UMACbb 2*2G/320/6L2.2/5R/ CB_bgn_0.3D_HG_EL31	AAM300	NLED15.6WXGAG	UMA	N	SO2GBII6	N320GB5.4KS	NSM8XS	3rd WiFi 1x2 BGN	N	N	65W	0.3M DV	Greek (KB.I170A.041)	Continental
AS5542-304G32Mn	EMEA	Serbia/ Macedonia	LX.PHA02.062	AS5542-304G32Mn W7HP64ATCS1 MC UMACbb 2*2G/320/6L2.2/5R/ CB_bgn_0.3D_HG_SL11	AAM300	NLED15.6WXGAG	UMA	N	SO2GBII6	N320GB5.4KS	NSM8XS	3rd WiFi 1x2 BGN	N	N	65W	0.3M DV	SLO/CRO (KB.I170A.049)	Continental
AS5542-304G32Mn	EMEA	Switzerland	LX.PHA02.061	AS5542-304G32Mn W7HP64ATCH1 MC UMACbb 2*2G/320/6L2.2/5R/ CB_bgn_0.3D_HG_IT41	AAM300	NLED15.6WXGAG	UMA	N	SO2GBII6	N320GB5.4KS	NSM8XS	3rd WiFi 1x2 BGN	N	N	65W	0.3M DV	Swiss/G (KB.I170A.052)	Swiss
AS5542-304G32Mn	EMEA	Luxembourg	LX.PHA02.060	AS5542-304G32Mn W7HP64ATLU3 MC UMACbb 2*2G/320/6L2.2/5R/ CB_bgn_0.3D_HG_IT41	AAM300	NLED15.6WXGAG	UMA	N	SO2GBII6	N320GB5.4KS	NSM8XS	3rd WiFi 1x2 BGN	N	N	65W	0.3M DV	Swiss/G (KB.I170A.052)	Continental
AS5542-304G32Mn	EMEA	Eastern Europe	LX.PHA02.059	AS5542-304G32Mn W7HP64ATEU7 MC UMACbb 2*2G/320/6L2.2/5R/ CB_bgn_0.3D_HG_SL11	AAM300	NLED15.6WXGAG	UMA	N	SO2GBII6	N320GB5.4KS	NSM8XS	3rd WiFi 1x2 BGN	N	N	65W	0.3M DV	SLO/CRO (KB.I170A.049)	Continental
AS5542-503G32Mn	PA	USA	LX.PHA02.052	AS5542-503G32Mn W7HP64ATU1 MC UMACbb 2G+1G/320/6L2.2/5R/ CB_bgn_0.3D_HG_FRB5	ATM500	NLED15.6WXGAG	UMA	N	SO2GBII6	N320GB5.4KS	NSM8XS	3rd WiFi 1x2 BGN	N	N	65W	0.3M DV	US International (KB.I170A.056)	US-110V
AS5542-604G32Bn	PA	ACLA-Spanish	LX.PHA02.043	AS5542-604G32Bn EM W7HP64EMATEA1 MC UMACbb 2*2G/320/6L2.2/5R/ CB_bgn_0.3D_HG_ES51	ATUM600	NLED15.6WXGAG	UMA	N	SO2GBII6	N320GB5.4KS	NBDCB4 XS	3rd WiFi 1x2 BGN	BT 2.1	N	65W	0.3M DV	Spanish (KB.I170A.050)	US-110V
AS5542-304G50Mn	EMEA	Spain	LX.PHA02.038	AS5542-304G50Mn W7HP64ATES1 MC UMACbb 2*2G/500_L/6L2.2/5R/ CB_bgn_0.3D_HG_ES51	AAM300	NLED15.6WXGAG	UMA	N	SO2GBII6	N500GB5.4KS	NSM8XS	3rd WiFi 1x2 BGN	N	N	65W	0.3M DV	Spanish (KB.I170A.050)	Continental
AS5542-304G50Mn	EMEA	Czech	LX.PHA0C.026	AS5542-304G50Mn LNPUSAC22 UMACbb 2*2G/500_L/6L2.2/5R/ CB_bgn_0.3D_HG_EN22	AAM300	NLED15.6WXGAG	UMA	N	SO2GBII6	N500GB5.4KS	NSM8XS	3rd WiFi 1x2 BGN	BT 2.1	N	65W	0.3M DV	CZ/SK (KB.I170A.035)	Continental
AS5542-303G32Mn	EMEA	Czech	LX.PHA02.057	AS5542-303G32Mn W7HP64ATC22 MC UMACbb 2G+1G/320/6L2.2/5R/ CB_bgn_0.3D_HG_SK11	AAM300	NLED15.6WXGAG	UMA	N	SO2GBII6	N320GB5.4KS	NSM8XS	3rd WiFi 1x2 BGN	BT 2.1	N	65W	0.3M DV	CZ/SK (KB.I170A.035)	Continental
AS5542-504G50Mn	PA	USA	LX.PHA02.002	AS5542-504G50Mn W7HP64ATU1 MC UMACbb 2*2G/500_L/6L2.2/5R/ CB_bgn_0.3D_HG_FRB1	ATM500	NLED15.6WXGAG	UMA	N	SO2GBII6	N500GB5.4KS	NSM8XS	3rd WiFi 1x2 BGN	N	N	65W	0.3M DV	US International (KB.I170A.056)	US-110V
AS5542-303G32Mn	PA	Canada	LX.PHA02.024	AS5542-303G32Mn W7HP64ATCA2 MC UMACbb 2G+1G/320/6L2.2/5R/ CB_bgn_0.3D_HG_FR81	AAM300	NLED15.6WXGAG	UMA	N	SO2GBII6	N320GB5.4KS	NSM8XS	3rd WiFi 1x2 BGN	N	N	65W	0.3M DV	US w/ Canadian French (KB.I170A.058)	US-110V
AS5542-303G32Mn	PA	ACLA-Portuguese	LX.PHA0C.025	AS5542-303G32Mn LNPUSAXC2 UMACbb 2G+1G/320/6L2.2/5R/ CB_bgn_0.3D_HG_EN62	AAM300	NLED15.6WXGAG	UMA	N	SO2GBII6	N320GB5.4KS	NSM8XS	3rd WiFi 1x2 BGN	N	N	65W	0.3M DV	Brazilian Portuguese (KB.I170A.034)	Brazil IMETRO
AS5542-302G25Mn	PA	ACLA-Portuguese	LX.PHA0C.023	AS5542-302G25Mn LNPUSAXC2 UMACbb 2*1G/250/6L2.2/5R/ CB_bgn_0.3D_HG_EN62	AAM300	NLED15.6WXGAG	UMA	N	SO1GBII6	N250GB5.4KS	NSM8XS	3rd WiFi 1x2 BGN	N	N	65W	0.3M DV	Brazilian Portuguese (KB.I170A.034)	Brazil IMETRO
AS5542-302G25Mn	PA	ACLA-Portuguese	LX.PHA0C.022	AS5542-302G25Mn LNPUSAXC3 UMACbb 2*1G/250/6L2.2/5R/ CB_bgn_0.3D_HG_EN61	AAM300	NLED15.6WXGAG	UMA	N	SO1GBII6	N250GB5.4KS	NSM8XS	3rd WiFi 1x2 BGN	N	N	65W	0.3M DV	US International (KB.I170A.056)	Brazil IMETRO
AS5542-302G32Mn	AAP	Japan	LX.PHA02.007	AS5542-302G32Mn W7HP64AJP1 MC UMACbb 1*2G/320/6L2.2/5R/ CB_bgn_0.3D_HG_JA11_M23	AAM300	NLED15.6WXGAG	UMA	N	SO2GBII6/N	N320GB5.4KS	NSM8XS	3rd WiFi 1x2 BGN	BT 2.1	N	65W	0.3M DV	Japanese (KB.I170A.044)	Japanese power cord
AS5542-504G50Mn	PA	ACLA-Portuguese	LX.PHA0C.021	AS5542-504G50Mn LNPUSAXC2 UMACbb 2*2G/500_L/6L2.2/5R/ CB_bgn_0.3D_HG_EN62	ATM500	NLED15.6WXGAG	UMA	N	SO2GBII6	N500GB5.4KS	NSM8XS	3rd WiFi 1x2 BGN	N	N	65W	0.3M DV	Brazilian Portuguese (KB.I170A.034)	Brazil IMETRO
AS5542-503G32Mn	PA	ACLA-Portuguese	LX.PHA0C.019	AS5542-503G32Mn LNPUSAXC2 UMACbb 2G+1G/320/6L2.2/5R/ CB_bgn_0.3D_HG_EN62	ATM500	NLED15.6WXGAG	UMA	N	SO2GBII6	N320GB5.4KS	NSM8XS	3rd WiFi 1x2 BGN	N	N	65W	0.3M DV	Brazilian Portuguese (KB.I170A.034)	Brazil IMETRO
AS5542-503G32Mn	PA	ACLA-Portuguese	LX.PHA0C.018	AS5542-503G32Mn LNPUSAXC3 UMACbb 2G+1G/320/6L2.2/5R/ CB_bgn_0.3D_HG_EN61	ATM500	NLED15.6WXGAG	UMA	N	SO2GBII6	N320GB5.4KS	NSM8XS	3rd WiFi 1x2 BGN	N	N	65W	0.3M DV	US International (KB.I170A.056)	Brazil IMETRO
AS5542-502G25Mn	PA	ACLA-Portuguese	LX.PHA0C.017	AS5542-502G25Mn LNPUSAXC2 UMACbb 2*1G/250/6L2.2/5R/ CB_bgn_0.3D_HG_EN62	ATM500	NLED15.6WXGAG	UMA	N	SO1GBII6	N250GB5.4KS	NSM8XS	3rd WiFi 1x2 BGN	N	N	65W	0.3M DV	Brazilian Portuguese (KB.I170A.034)	Brazil IMETRO

Model	RO	Country	Acer Part No	Description	CPU	LCD	VGA Chip	VRAM 1	Memory 1/ Memory 2	HDD 1 (GB)	ODD	Wireless LAN1	Bluetooth	Finger Print	Adapter	Camera	K/B	Power Cord
AS5542-502G25Mn	PA	ACLA-Portuguese	LX.PHA0C.016	AS5542-502G25Mn LNPUSAXG3 UMACbb 2*1G/250/6L2.2/5R/ CB_bgn_0.3D_HG_EN61	ATM500	NLED15.6WXGAG	UMA	N	SO1GBII6	N250GB5.4KS	NSM8XS	3rd WiFi 1x2 BGN	N	N	65W	0.3M DV	US International (KB.I170A.056)	Brazil IMETRO
AS5542-303G25Mn	EMEA	Eastern Europe	LX.PHA0C.015	AS5542-303G25Mn LNPUSAEU5 UMACbb 2G+1G/250/6L2.2/5R/ CB_bgn_0.3D_HG_ENF1	AAM300	NLED15.6WXGAG	UMA	N	SO2GBII6	N250GB5.4KS	NSM8XS	3rd WiFi 1x2 BGN	N	N	65W	0.3M DV	US International (KB.I170A.056)	Continental
AS5542-303G25Mn	EMEA	Eastern Europe	LX.PHA0C.013	AS5542-303G25Mn LNPUSAEU5 UMACbb 2G+1G/320/BT/6L2.2/5R/ CB_bgn_0.3D_HG_ENF1	AAM300	NLED15.6WXGAG	UMA	N	SO2GBII6	N250GB5.4KS	NSM8XS	3rd WiFi 1x2 BGN	BT 2.1	N	65W	0.3M DV	US International (KB.I170A.056)	Continental
AS5542-303G32Mn	EMEA	Eastern Europe	LX.PHA0C.012	AS5542-303G32Mn LNPUSAEU5 UMACbb 2G+1G/320/BT/6L2.2/5R/ CB_bgn_0.3D_HG_ENF1	AAM300	NLED15.6WXGAG	UMA	N	SO2GBII6	N320GB5.4KS	NSM8XS	3rd WiFi 1x2 BGN	BT 2.1	N	65W	0.3M DV	US International (KB.I170A.056)	Continental
AS5542-304G50Mn	EMEA	Eastern Europe	LX.PHA0C.011	AS5542-304G50Mn LNPUSAEU5 UMACbb 2*2G/500_L/BT/6L2.2/5R/ CB_bgn_0.3D_HG_ENF1	AAM300	NLED15.6WXGAG	UMA	N	SO2GBII6	N500GB5.4KS	NSM8XS	3rd WiFi 1x2 BGN	BT 2.1	N	65W	0.3M DV	US International (KB.I170A.056)	Continental
AS5542-303G25Mn	EMEA	Czech	LX.PHA02.054	AS5542-303G25Mn W7HP64ATCZ2 MC UMACbb 2G+1G/250/6L2.2/5R/ CB_bgn_0.3D_HG_SK11	AAM300	NLED15.6WXGAG	UMA	N	SO2GBII6	N250GB5.4KS	NSM8XS	3rd WiFi 1x2 BGN	N	N	65W	0.3M DV	CZ/SK (KB.I170A.035)	Continental
AS5542-504G50Mn	EMEA	UK	LX.PHA02.003	AS5542-504G50Mn W7HP64ATGB1 MC UMACbb 2*2G/500_L/6L2.2/5R/ CB_bgn_0.3D_N_HG_EN11	ATM500	NLED15.6WXGAG	UMA	N	SO2GBII6	N500GB5.4KS	NSM8XS	3rd WiFi 1x2 BGN	N	N	65W	0.3M DV	UK (KB.I170A.055)	UK
AS5542-304G25Mn	EMEA	UK	LX.PHA02.017	AS5542-304G25Mn W7HP64ATGB1 MC UMACbb 2*2G/250/6L2.2/5R/ CB_bgn_0.3D_HG_EN11	AAM300	NLED15.6WXGAG	UMA	N	SO2GBII6	N250GB5.4KS	NSM8XS	3rd WiFi 1x2 BGN	N	N	65W	0.3M DV	UK (KB.I170A.055)	UK
AS5542-503G32Mn	PA	USA	LX.PHA02.051	AS5542-503G32Mn W7HP64ATU1 MC UMACbb 2G+1G/320/6L2.2/5R/ CB_bgn_0.3D_HG_FRB2	ATM500	NLED15.6WXGAG	UMA	N	SO2GBII6	N320GB5.4KS	NSM8XS	3rd WiFi 1x2 BGN	N	N	65W	0.3M DV	US International (KB.I170A.056)	US-110V
AS5542-503G32Mn	PA	USA	LX.PHA02.050	AS5542-503G32Mn W7HP64ATU1 MC UMACbb 2G+1G/320/6L2.2/5R/ CB_bgn_0.3D_HG_FRB1	ATM500	NLED15.6WXGAG	UMA	N	SO2GBII6	N320GB5.4KS	NSM8XS	3rd WiFi 1x2 BGN	N	N	65W	0.3M DV	US International (KB.I170A.056)	US-110V
AS5542-503G32Mn	PA	Canada	LX.PHA02.049	AS5542-503G32Mn W7HP64ATCA2 MC UMACbb 2G+1G/320/6L2.2/5R/ CB_bgn_0.3D_HG_FR84	ATM500	NLED15.6WXGAG	UMA	N	SO2GBII6	N320GB5.4KS	NSM8XS	3rd WiFi 1x2 BGN	N	N	65W	0.3M DV	US w/ Canadian French (KB.I170A.058)	US-110V
AS5542-503G32Mn	PA	Canada	LX.PHA02.048	AS5542-503G32Mn W7HP64ATCA2 MC UMACbb 2G+1G/320/6L2.2/5R/ CB_bgn_0.3D_HG_FR82	ATM500	NLED15.6WXGAG	UMA	N	SO2GBII6	N320GB5.4KS	NSM8XS	3rd WiFi 1x2 BGN	N	N	65W	0.3M DV	US w/ Canadian French (KB.I170A.058)	US-110V
AS5542-503G32Mn	PA	Canada	LX.PHA02.047	AS5542-503G32Mn W7HP64ATCA2 MC UMACbb 2G+1G/320/6L2.2/5R/ CB_bgn_0.3D_HG_FR81	ATM500	NLED15.6WXGAG	UMA	N	SO2GBII6	N320GB5.4KS	NSM8XS	3rd WiFi 1x2 BGN	N	N	65W	0.3M DV	US w/ Canadian French (KB.I170A.058)	US-110V
AS5542-604G50Bn	PA	ACLA-Spanish	LX.PHA02.046	AS5542-604G50Bn EM W7HP64EMATEA1 MC UMACbb 2*2G/500_L/BT/6L2.2/5R/ CB_bgn_0.3D_HG_ES51	ATUM600	NLED15.6WXGAG	UMA	N	SO2GBII6	N500GB5.4KS	NBDCB4 XS	3rd WiFi 1x2 BGN	BT 2.1	N	65W	0.3M DV	Spanish (KB.I170A.050)	US-110V
AS5542-604G32Bn	PA	Chile	LX.PHA02.045	AS5542-604G32Bn EM W7HP64EMATCL3 MC UMACbb 2*2G/320/BT/6L2.2/5R/ CB_bgn_0.3D_HG_ES51	ATUM600	NLED15.6WXGAG	UMA	N	SO2GBII6	N320GB5.4KS	NBDCB4 XS	3rd WiFi 1x2 BGN	BT 2.1	N	65W	0.3M DV	Spanish (KB.I170A.050)	Italian
AS5542-604G32Bn	PA	ACLA-Spanish	LX.PHA02.044	AS5542-604G32Bn EM W7HP64EMATEA4 MC UMACbb 2*2G/320/BT/6L2.2/5R/ CB_bgn_0.3D_HG_EN31	ATUM600	NLED15.6WXGAG	UMA	N	SO2GBII6	N320GB5.4KS	NBDCB4 XS	3rd WiFi 1x2 BGN	BT 2.1	N	65W	0.3M DV	US International (KB.I170A.056)	US-110V
AS5542-604G32Bn	PA	ACLA-Spanish	LX.PHA02.042	AS5542-604G32Bn EM W7HP64EMATEA3 MC UMACbb 2*2G/320/BT/6L2.2/5R/ CB_bgn_0.3D_HG_ES51	ATUM600	NLED15.6WXGAG	UMA	N	SO2GBII6	N320GB5.4KS	NBDCB4 XS	3rd WiFi 1x2 BGN	BT 2.1	N	65W	0.3M DV	Spanish (KB.I170A.050)	Argentine Power Cord
AS5542-604G32Bn	PA	ACLA-Portuguese	LX.PHA02.041	AS5542-604G32Bn EM W7HP64EMATXC3 MC UMACbb 2*2G/320/BT/6L2.2/5R/ CB_bgn_0.3D_HG_EN61	ATUM600	NLED15.6WXGAG	UMA	N	SO2GBII6	N320GB5.4KS	NBDCB4 XS	3rd WiFi 1x2 BGN	BT 2.1	N	65W	0.3M DV	US International (KB.I170A.056)	Brazil IMETRO

Model	RO	Country	Acer Part No	Description	CPU	LCD	VGA Chip	VRAM 1	Memory 1/ Memory 2	HDD 1 (GB)	ODD	Wireless LAN1	Bluetooth	Finger Print	Adapter	Camera	K/B	Power Cord
AS5542-604G32Bn	PA	ACLA-Portuguese	LX.PHA02.040	AS5542-604G32Bn EM W7HP64EMATXC2 MC UMACbb 2*2G/320/BT/6L2.2/5R/CB_bgn_0.3D_HG_XC21	ATUM600	NLED15.6WXGAG	UMA	N	SO2GBIIE	N320GB5.4KS	NBDCB4 XS	3rd WiFi 1x2 BGN	BT 2.1	N	65W	0.3M DV	Brazilian Portuguese (KB.1170A.034)	Brazil IMETRO
AS5542-302G50Mn	EMEA	Czech	LX.PHA0C.009	AS5542-302G50Mn LIMPUSACZ2 UMACbb 1*2G/500_L/BT/6L2.2/5R/CB_bgn_0.3D_HG_EN22	AAM300	NLED15.6WXGAG	UMA	N	SO2GBIIE/N	N500GB5.4KS	NSM8XS	3rd WiFi 1x2 BGN	BT 2.1	N	65W	0.3M DV	CZ/SK (KB.1170A.035)	Continental
AS5542-304G32Mn	EMEA	Czech	LX.PHA02.039	AS5542-304G32Mn W7HP64ATCZ2 MC UMACbb 2*2G/320/BT/6L2.2/5R/CB_bgn_0.3D_HG_SK11	AAM300	NLED15.6WXGAG	UMA	N	SO2GBIIE	N320GB5.4KS	NSM8XS	3rd WiFi 1x2 BGN	BT 2.1	N	65W	0.3M DV	CZ/SK (KB.1170A.035)	Continental
AS5542-304G50Mn	EMEA	Luxembourg	LX.PHA02.035	AS5542-304G50Mn W7HP64ATL3 MC UMACbb 2*2G/500_L/6L2.2/5R/CB_bgn_0.3D_HG_IT41	AAM300	NLED15.6WXGAG	UMA	N	SO2GBIIE	N500GB5.4KS	NSM8XS	3rd WiFi 1x2 BGN	N	N	65W	0.3M DV	Swiss/G (KB.1170A.052)	Continental
AS5542-504G50Mn	EMEA	Czech	LX.PHA0C.008	AS5542-504G50Mn LIMPUSACZ2 UMACbb 2*2G/500_L/BT/6L2.2/5R/CB_bgn_0.3D_HG_EN22	ATM500	NLED15.6WXGAG	UMA	N	SO2GBIIE	N500GB5.4KS	NSM8XS	3rd WiFi 1x2 BGN	BT 2.1	N	65W	0.3M DV	CZ/SK (KB.1170A.035)	Continental
AS5542-304G32Mn	PA	Canada	LX.PHA02.032	AS5542-304G32Mn W7HP64ATCA2 MC UMACbb 2*2G/320/6L2.2/5R/CB_bgn_0.3D_HG_FR81	AAM300	NLED15.6WXGAG	UMA	N	SO2GBIIE	N320GB5.4KS	NSM8XS	3rd WiFi 1x2 BGN	N	N	65W	0.3M DV	US w/ Canadian French (KB.1170A.058)	US-110V
AS5542-303G25Mn	PA	Chile	LX.PHA02.031	AS5542-303G25Mn EM W7HP64EMATCL3 MC UMACbb 2G+1G/250/6L2.2/5R/CB_bgn_0.3D_HG_ES51	AAM300	NLED15.6WXGAG	UMA	N	SO2GBIIE	N250GB5.4KS	NSM8XS	3rd WiFi 1x2 BGN	N	N	65W	0.3M DV	Spanish (KB.1170A.050)	Italian
AS5542-303G25Mn	PA	ACLA-Spanish	LX.PHA02.030	AS5542-303G25Mn EM W7HP64EMATEA4 MC UMACbb 2G+1G/250/6L2.2/5R/CB_bgn_0.3D_HG_EN31	AAM300	NLED15.6WXGAG	UMA	N	SO2GBIIE	N250GB5.4KS	NSM8XS	3rd WiFi 1x2 BGN	N	N	65W	0.3M DV	US International (KB.1170A.056)	US-110V
AS5542-303G25Mn	PA	ACLA-Spanish	LX.PHA02.029	AS5542-303G25Mn EM W7HP64EMATEA1 MC UMACbb 2G+1G/250/6L2.2/5R/CB_bgn_0.3D_HG_ES51	AAM300	NLED15.6WXGAG	UMA	N	SO2GBIIE	N250GB5.4KS	NSM8XS	3rd WiFi 1x2 BGN	N	N	65W	0.3M DV	Spanish (KB.1170A.050)	US-110V
AS5542-303G25Mn	PA	ACLA-Spanish	LX.PHA02.028	AS5542-303G25Mn EM W7HP64EMATEA3 MC UMACbb 2G+1G/250/6L2.2/5R/CB_bgn_0.3D_HG_ES51	AAM300	NLED15.6WXGAG	UMA	N	SO2GBIIE	N250GB5.4KS	NSM8XS	3rd WiFi 1x2 BGN	N	N	65W	0.3M DV	Spanish (KB.1170A.050)	Argentine Power Cord
AS5542-303G25Mn	PA	ACLA-Portuguese	LX.PHA02.027	AS5542-303G25Mn EM W7HP64EMATXC3 MC UMACbb 2G+1G/250/6L2.2/5R/CB_bgn_0.3D_HG_EN61	AAM300	NLED15.6WXGAG	UMA	N	SO2GBIIE	N250GB5.4KS	NSM8XS	3rd WiFi 1x2 BGN	N	N	65W	0.3M DV	US International (KB.1170A.056)	Brazil IMETRO
AS5542-303G25Mn	PA	ACLA-Portuguese	LX.PHA02.026	AS5542-303G25Mn EM W7HP64EMATXC2 MC UMACbb 2G+1G/250/6L2.2/5R/CB_bgn_0.3D_HG_XC21	AAM300	NLED15.6WXGAG	UMA	N	SO2GBIIE	N250GB5.4KS	NSM8XS	3rd WiFi 1x2 BGN	N	N	65W	0.3M DV	Brazilian Portuguese (KB.1170A.034)	Brazil IMETRO
AS5542-504G50Bn	PA	Chile	LX.PHA0C.007	AS5542-504G50Bn LIMPUSACL3 UMACbb 2*2G/500_L/6L2.2/5R/CB_bgn_0.3D_HG_EN61	ATM500	NLED15.6WXGAG	UMA	N	SO2GBIIE	N500GB5.4KS	NBDCB4 XS	3rd WiFi 1x2 BGN	N	N	65W	0.3M DV	Spanish (KB.1170A.050)	Italian
AS5542-504G50Bn	PA	ACLA-Spanish	LX.PHA0C.006	AS5542-504G50Bn LIMPUSAE4 UMACbb 2*2G/500_L/6L2.2/5R/CB_bgn_0.3D_HG_EN62	ATM500	NLED15.6WXGAG	UMA	N	SO2GBIIE	N500GB5.4KS	NBDCB4 XS	3rd WiFi 1x2 BGN	N	N	65W	0.3M DV	US International (KB.1170A.056)	US-110V
AS5542-504G50Bn	PA	ACLA-Spanish	LX.PHA0C.005	AS5542-504G50Bn LIMPUSAE1 UMACbb 2*2G/500_L/6L2.2/5R/CB_bgn_0.3D_HG_EN62	ATM500	NLED15.6WXGAG	UMA	N	SO2GBIIE	N500GB5.4KS	NBDCB4 XS	3rd WiFi 1x2 BGN	N	N	65W	0.3M DV	Spanish (KB.1170A.050)	US-110V
AS5542-504G50Bn	PA	ACLA-Spanish	LX.PHA0C.004	AS5542-504G50Bn LIMPUSAE3 UMACbb 2*2G/500_L/6L2.2/5R/CB_bgn_0.3D_HG_EN61	ATM500	NLED15.6WXGAG	UMA	N	SO2GBIIE	N500GB5.4KS	NBDCB4 XS	3rd WiFi 1x2 BGN	N	N	65W	0.3M DV	Spanish (KB.1170A.050)	Argentine Power Cord
AS5542-504G50Bn	PA	ACLA-Portuguese	LX.PHA0C.002	AS5542-504G50Bn LIMPUSAXC1 UMACbb 2*2G/500_L/6L2.2/5R/CB_bgn_0.3D_HG_EN61	ATM500	NLED15.6WXGAG	UMA	N	SO2GBIIE	N500GB5.4KS	NBDCB4 XS	3rd WiFi 1x2 BGN	N	N	65W	0.3M DV	Brazilian Portuguese (KB.1170A.034)	US-110V
AS5542-604G32Mn	PA	ACLA-Spanish	LX.PHA02.025	AS5542-604G32Mn EM W7HP64EMATEA1 MC UMACbb 2*2G/320/BT/6L2.2/5R/CB_bgn_0.3D_HG_ES51	ATUM600	NLED15.6WXGAG	UMA	N	SO2GBIIE	N320GB5.4KS	NSM8XS	3rd WiFi 1x2 BGN	BT 2.1	N	65W	0.3M DV	Spanish (KB.1170A.050)	US-110V
AS5542-303G25Mn	PA	ACLA-Portuguese	LX.PHA01.001	AS5542-303G25Mn EM W7HP64EMATXC2 MC UMACbb 2G+1G/250/6L2.2/5R/CB_bgn_0.3D_HG_XC21	AAM300	NLED15.6WXGAG	UMA	N	SO2GBIIE	N250GB5.4KS	NSM8XS	3rd WiFi 1x2 BGN	N	N	65W	0.3M DV	Brazilian Portuguese (KB.1170A.034)	Brazil IMETRO

Model	RO	Country	Acer Part No	Description	CPU	LCD	VGA Chip	VRAM 1	Memory 1/ Memory 2	HDD 1 (GB)	ODD	Wireless LAN1	Bluetooth	Finger Print	Adapter	Camera	K/B	Power Cord
AS5542-504G32Mn	PA	ACLA-Portuguese	LX.PHA02.008	AS5542-504G32Mn EM W7HP64EMATXC2 MC UMACbb 2*2G/320/6L2.2/5R/CB_bgn_0.3D_HG_XC21	ATM500	NLED15.6WXGAG	UMA	N	SO2GBI16	N320GB5.4KS	NSM8XS	3rd WiFi 1x2 BGN	N	N	65W	0.3M DV	Brazilian Portuguese (KB.I170A.034)	Brazil IMETRO
AS5542-504G50Mn	PA	USA	LX.PHA02.023	AS5542-504G50Mn W7HP64ATU1 MC UMACbb 2*2G/500_L/6L2.2/5R/CB_bgn_0.3D_HG_FRB3	ATM500	NLED15.6WXGAG	UMA	N	SO2GBI16	N500GB5.4KS	NSM8XS	3rd WiFi 1x2 BGN	N	N	65W	0.3M DV	US International (KB.I170A.056)	US-110V
AS5542-504G50Mn	PA	USA	LX.PHA02.022	AS5542-504G50Mn W7HP64ATU1 MC UMACbb 2*2G/500_L/6L2.2/5R/CB_bgn_0.3D_HG_FRB2	ATM500	NLED15.6WXGAG	UMA	N	SO2GBI16	N500GB5.4KS	NSM8XS	3rd WiFi 1x2 BGN	N	N	65W	0.3M DV	US International (KB.I170A.056)	US-110V
AS5542-504G50Mn	PA	Canada	LX.PHA02.021	AS5542-504G50Mn W7HP64ATCA2 MC UMACbb 2*2G/500_L/6L2.2/5R/CB_bgn_0.3D_HG_FR84	ATM500	NLED15.6WXGAG	UMA	N	SO2GBI16	N500GB5.4KS	NSM8XS	3rd WiFi 1x2 BGN	N	N	65W	0.3M DV	US w/ Canadian French (KB.I170A.058)	US-110V
AS5542-504G50Mn	PA	Canada	LX.PHA02.020	AS5542-504G50Mn W7HP64ATCA2 MC UMACbb 2*2G/500_L/6L2.2/5R/CB_bgn_0.3D_HG_FR82	ATM500	NLED15.6WXGAG	UMA	N	SO2GBI16	N500GB5.4KS	NSM8XS	3rd WiFi 1x2 BGN	N	N	65W	0.3M DV	US w/ Canadian French (KB.I170A.058)	US-110V
AS5542-504G50Mn	PA	Canada	LX.PHA02.019	AS5542-504G50Mn W7HP64ATCA2 MC UMACbb 2*2G/500_L/6L2.2/5R/CB_bgn_0.3D_HG_FR81	ATM500	NLED15.6WXGAG	UMA	N	SO2GBI16	N500GB5.4KS	NSM8XS	3rd WiFi 1x2 BGN	N	N	65W	0.3M DV	US w/ Canadian French (KB.I170A.058)	US-110V
AS5542-324G32Mn	AAP	Australia/New Zealand	LX.PHA02.018	AS5542-324G32Mn W7HP64ATAU1 MC UMACbb 2*2G/320/6L2.2/5R/CB_bgn_0.3D_HG_ES61	AAM320	NLED15.6WXGAG	UMA	N	SO2GBI16	N320GB5.4KS	NSM8XS	3rd WiFi 1x2 BGN	N	N	65W	0.3M DV	US International (KB.I170A.056)	Australia w/ label
AS5542-302G32Mn	AAP	Australia/New Zealand	LX.PHA02.016	AS5542-302G32Mn W7HP64ATAU1 MC UMACbb 1*2G/320/6L2.2/5R/CB_bgn_0.3D_HG_ES61	AAM300	NLED15.6WXGAG	UMA	N	SO2GBI16/N	N320GB5.4KS	NSM8XS	3rd WiFi 1x2 BGN	N	N	65W	0.3M DV	US International (KB.I170A.056)	Australia w/ label
AS5542-504G32Mn	AAP	Australia/New Zealand	LX.PHA02.014	AS5542-504G32Mn W7HP64ATAU1 MC UMACbb 2*2G/320/6L2.2/5R/CB_bgn_0.3D_HG_ES61	ATM500	NLED15.6WXGAG	UMA	N	SO2GBI16	N320GB5.4KS	NSM8XS	3rd WiFi 1x2 BGN	N	N	65W	0.3M DV	US International (KB.I170A.056)	Australia w/ label
AS5542-504G32Mn	PA	Chile	LX.PHA02.013	AS5542-504G32Mn EM W7HP64EMATCL3 MC UMACbb 2*2G/320/6L2.2/5R/CB_bgn_0.3D_HG_ES51	ATM500	NLED15.6WXGAG	UMA	N	SO2GBI16	N320GB5.4KS	NSM8XS	3rd WiFi 1x2 BGN	N	N	65W	0.3M DV	Spanish (KB.I170A.050)	Italian
AS5542-504G32Mn	PA	ACLA-Spanish	LX.PHA02.012	AS5542-504G32Mn EM W7HP64EMATEA4 MC UMACbb 2*2G/320/6L2.2/5R/CB_bgn_0.3D_HG_EN31	ATM500	NLED15.6WXGAG	UMA	N	SO2GBI16	N320GB5.4KS	NSM8XS	3rd WiFi 1x2 BGN	N	N	65W	0.3M DV	US International (KB.I170A.056)	US-110V
AS5542-504G32Mn	PA	ACLA-Portuguese	LX.PHA02.009	AS5542-504G32Mn EM W7HP64EMATXC3 MC UMACbb 2*2G/320/6L2.2/5R/CB_bgn_0.3D_HG_EN61	ATM500	NLED15.6WXGAG	UMA	N	SO2GBI16	N320GB5.4KS	NSM8XS	3rd WiFi 1x2 BGN	N	N	65W	0.3M DV	US International (KB.I170A.056)	Brazil IMETRO
AS5542-504G32Mn	PA	ACLA-Spanish	LX.PHA02.011	AS5542-504G32Mn EM W7HP64EMATEA1 MC UMACbb 2*2G/320/6L2.2/5R/CB_bgn_0.3D_HG_ES51	ATM500	NLED15.6WXGAG	UMA	N	SO2GBI16	N320GB5.4KS	NSM8XS	3rd WiFi 1x2 BGN	N	N	65W	0.3M DV	Spanish (KB.I170A.050)	US-110V
AS5542-504G32Mn	PA	Canada	LX.PHA02.001	AS5542-504G32Mn W7HP64ATCA2 MC UMACbb 2*2G/320/6L2.2/5R/CB_bgn_0.3D_HG_FR81	ATM500	NLED15.6WXGAG	UMA	N	SO2GBI16	N320GB5.4KS	NSM8XS	3rd WiFi 1x2 BGN	N	N	65W	0.3M DV	US w/ Canadian French (KB.I170A.058)	US-110V
AS5542-604G32Mn	PA	Canada	LX.PHA02.004	AS5542-604G32Mn W7HP64ATCA2 MC UMACbb 2*2G/320/6L2.2/5R/CB_bgn_0.3D_HG_FR82	ATUM600	NLED15.6WXGAG	UMA	N	SO2GBI16	N320GB5.4KS	NSM8XS	3rd WiFi 1x2 BGN	N	N	65W	0.3M DV	US w/ Canadian French (KB.I170A.058)	US-110V
AS5542-604G32Mn	PA	Canada	LX.PHA02.005	AS5542-604G32Mn W7HP64ATCA2 MC UMACbb 2*2G/320/6L2.2/5R/CB_bgn_0.3D_HG_FR81	ATUM600	NLED15.6WXGAG	UMA	N	SO2GBI16	N320GB5.4KS	NSM8XS	3rd WiFi 1x2 BGN	N	N	65W	0.3M DV	US w/ Canadian French (KB.I170A.058)	US-110V
AS5542-304G32Mn	EMEA	UK	LX.PHA02.006	AS5542-304G32Mn W7HP64ATGB1 MC UMACbb 2*2G/320/6L2.2/5R/CB_bgn_0.3D_HG_EN11	AAM300	NLED15.6WXGAG	UMA	N	SO2GBI16	N320GB5.4KS	NSM8XS	3rd WiFi 1x2 BGN	N	N	65W	0.3M DV	UK (KB.I170A.055)	UK
AS5542-622G32Mn	AAP	Vietnam	LX.PHA0C.001	AS5542-622G32Mn LINPUSAVN1 UMACbb 1*2G/320/6L2.2/5R/CB_bgn_0.3D_HG_EN11	ATUM620	NLED15.6WXGAG	UMA	N	SO2GBI16/N	N320GB5.4KS	NSM8XS	3rd WiFi 1x2 BGN	BT 2.1	N	65W	0.3M DV	US International (KB.I170A.056)	Europe
AS5542-623G32Mn	WW	GCTWN	S2.PHA0C.001	AS5542-623G32Mn LINPUSAWW1 UMACbb 2G+1G/320/6L2.2/5R/CB_bgn_0.3D_HG_ENX1	ATUM620	NLED15.6WXGAG	UMA	N	SO2GBI16	N320GB5.4KS	NSM8XS	3rd WiFi 1x2 BGN	BT 2.1	N	65W	0.3M DV	US International (KB.I170A.056)	US and Continental
AS5542-504G50Mn	EMEA	UK	LX.PH902.002	AS5542-504G50Mn W7HP64ATGB1 MC UMAbb 2*2G/500_L/6L2.2/5R/CB_bgn_HG_EN11	ATM500	NLED15.6WXGAG	UMA	N	SO2GBI16	N500GB5.4KS	NSM8XS	3rd WiFi 1x2 BGN	N	N	65W	N	UK (KB.I170A.055)	UK

Model	RO	Country	Acer Part No	Description	CPU	LCD	VGA Chip	VRAM 1	Memory 1/ Memory 2	HDD 1(GB)	ODD	Wireless LAN1	Bluetooth	Finger Print	Adapter	Camera	K/B	Power Cord
AS5542-303G32Mn	EMEA	Germany	LX.PH902.001	AS5542-303G32Mn W7HP64TDE1 MC UMAbb 2G+1G/320/6L2.2/5R/ CB_bgn_HG_DE11	AAM300	NLED15.6WXGAG	UMA	N	SO2GBII6	N320GB5.4KS	NSM8XS	3rd WiFi 1x2 BGN	N	N	65W	N	German (KB.1170A.040)	Continental
AS5542-623G32Mn	WW	GCTWN	S2.PH90C.001	AS5542-623G32Mn L1NPUSAWW1 UMAbb 2G+1G/320/BT/6L2.2/5R/ CB_bgn_HG_ENX1	ATUM620	NLED15.6WXGAG	UMA	N	SO2GBII6	N320GB5.4KS	NSM8XS	3rd WiFi 1x2 BGN	BT 2.1	N	65W	N	US International (KB.1170A.056)	US and Continental





---











---









# Test Compatible Components

---

This computer's compatibility is tested and verified by Acer's internal testing department. All of its system functions are tested under compatible Windows® operating system for each model.

Refer to the following lists for components, adapter cards, and peripherals which have passed these tests. Regarding configuration, combination and test procedures, please refer to the Compatibility Test Report released by the Acer Mobile System Testing Department.

# Microsoft® Windows® Environment Test

Item	Specification
<b>CRT Port Test</b>	
CRT Monitor	Acer 211c 21", ViewSonic G220F, ViewSonic PF790 19"
LCD Monitor	Acer FP751 17" TFT LCD, Acer AL1521, Acer AL1721, ViewSonic VD201b, Westinghouse W37G, HP LP2065, HP S9500
Projector	Dell 3300MP
<b>USB Port Test</b>	
USB Keyboard/Mouse	Microsoft Natural Keyboard Pro Dell USB Keyboard Logicool USB Mouse (OWCM-USB) Logitech USB Wheel Mouse Logitech First Wheel Mouse Dell by Logitech Dell Internet Navigator Keyboard Dell Smart Card Keyboard HP USB Optical Austin Mouse Belkin Miniglow Optical USB Mouse HP USB Optical Mouse (RB129AA)
USB Speaker/Joystick	Aiwa Multimedia Digital Speaker (SC-UC78) Panasonic USB Speaker EAB-MPC57USB
USB Storage Drive	Iomega USB Zip 250MB Transcend 80G HDD Plextor DVD+R/RW LG DVD+R/RW Sony DVD+R/RW
USB Camera	Intel Easy PC Camera (A20953-001) Orange Micro USB 2.0 Web Cam
USB HUB and Others	A TEN UH-204 IOGEAR 4-Port Hub Corega CG-WLUSBST11
USB Printer/Scanner	HP 450WBT Deskjet Printer
USB Flash Drive	Sony Memory Key 128MB Sony Micro Vault Pro USD-5G IBM 128MB Memory Key IBM 512MB Memory Key Apacer Handy Drive Apacer The USB Flash Drive 256MB
USB ODD	Logitech CDRW+DVDROM combo LG DVD+R/RW Sony DVD+R/RW
1394 Camera	Sony DV-TRV10
Access Point 802.11a	Intel Pro/Wireless 5000 NetGear HE 102
Access Point 802.11g	D-Link Building Networks People WiFi Certified a/b/g Wireless 108AG
Access Point 802.11n	Belkin N1MIMO Wireless Router High Performance wireless 802.11n
Bluetooth Device	Sony Ericsson Wireless Headset Sony Ericsson T610 X Bridge Bluetooth Access Point BT300

Item	Specification
<b>PCMCIA Test</b>	
LAN/Modem Card	TDK CardBus Ethernet 10/100 32-Bit CBE-10/100BTX
Storage Card	Hitachi Microdrive 4G
1394 Card	Buffalo 1394 Interface Cardbus (IFC-ILCB/DV)
USB2.0 Card	IBM EtherJet CardBus Adapter 10/100
Wireless Lan Card (Not recommended for wireless ready model)	Cisco Wireless LAN Card 802.11a NETGEAR Wireless LAN card 802.11a
ISDN Card	Toshiba Type B for Bluetooth 128K ISDN Card
GPRS Card	Vodafone QL1ACC-21581 3G/GPRS card Sony Ericsson GC83 GPRS card Sony Ericsson GC89 GPRS card
<b>ExpressCard Test</b>	
Express Card	Abcom 5-in-1 Adapter ExpressCard Reader Abcom GigaLan ExpressCard Sunix ECF2400 2 Ports 1394A ExpressCard
<b>Memory Card Test (SD/MS/MMC/SM/CF/Microdrive/XD)</b>	
SD Card	Apacer 128/256MB SanDisk 256MB Apacer 2GB (150x Hi-Speed) KINGMAX 1GB (66x Hi-Speed) SanDisk 1GB RiDATA 4GB SD PRO Memory Card
MS Card	Sony 512 MS PRO Lexar 512MB MS PRO Lexar 1GB MS PRO Sony 2GB MS PRO
MMC Card	SanDisk 32MB Transcend 64/128MB Transcend 256MB SanDisk RS-MMC 128MB PQI RS-MMC 256MB Transcend 512MB A-DATA Turbo 200X 2GB MMC Card
XD Card	Apacer 256/512MB SanDisk 2GB Olympus 512MB
CF Card	Apacer 256/512 SanDisk 2GB



# Online Support Information

---

This section describes online technical support services available to help you repair your Acer Systems.

If you are a distributor, dealer, ASP or TPM, please refer your technical queries to your local Acer branch office. Acer Branch Offices and Regional Business Units may access our website. However some information sources will require a user i.d. and password. These can be obtained directly from Acer CSD Taiwan.

Acer's Website offers you convenient and valuable support resources whenever you need them.

In the Technical Information section you can download information on all of Acer's Notebook, Desktop and Server models including:

- Service guides for all models
- User's manuals
- Training materials
- Bios updates
- Software utilities
- Spare parts lists
- TABs (Technical Announcement Bulletin)

For these purposes, we have included an Acrobat File to facilitate the problem-free downloading of our technical material.

Also contained on this website are:

- Detailed information on Acer's International Traveller's Warranty (ITW)
- Returned material authorization procedures
- An overview of all the support services we offer, accompanied by a list of telephone, fax and email contacts for all your technical queries.

We are always looking for ways to optimize and improve our services, so if you have any suggestions or comments, please do not hesitate to communicate these to us.





**A**

AFLASH Utility 39  
 antennas  
   removing 92  
 Audio 24

**B**

back cover 47  
 Battery Pack 44  
 battery power indicator 12  
 BIOS 19  
   vendor 19  
   Version 19  
 BIOS Recovery 115  
 BIOS Recovery Boot Block 117  
 BIOS Recovery by Crisis Disk 117  
   steps 117  
 BIOS Recovery Hotkey 117  
 BIOS Utility 27–39  
   Navigating 28  
   Security 32  
   System Security 38  
 block diagram  
   Aspire 5536/5536G/5236 Series 5  
   Aspire 5738G/5738ZG/5738Z/5738/5338  
     Series 4, 6  
 brightness  
   hotkeys 15  
 button/indicator  
   3G WWAN 7, 12  
   bluetooth 7, 12  
   wireless LAN 7, 12  
 buttons  
   easy-launch 12

**C**

caps lock  
   on indicator 8  
 Clearing BIOS Password  
   steps 116  
 Clearing Password 115  
 computer

  on indicator 8, 12

CPU  
   removing 81  
 CPU Fan True Value Table 19  
 Crisis Disk 39  
   creating 117

**D**

DIMM Module 46  
 display  
   hotkeys 15

**E**

Error Symptom-to-Spare Part Index 98  
 Euro 16  
 External CD-ROM Drive Check 96  
 External Module Disassembly  
   Flowchart 43

**F**

Flash Utility 39  
 FRU (Field Replaceable Unit) List 121

**H**

Hard disk 21  
 Hard Disk Drive Module 48  
 HDD 21  
 Hibernation mode  
   hotkey 15  
 Hot Keys 13  
 HW Gap position 115

**I**

Indicators 12  
 Intermittent Problems 111

**J**

Jumper and Connector Locations 113  
   Top View 113

**K**

---

- key 12
  - backup 7
- Keyboard 25
  - removing 58
- Keyboard or Auxiliary Input Device Check 96

## L

- LCD bezel
  - removing 84
- LCD Brackets
  - removing 89
- LCD Module Disassembly
  - Flowchart 83
- LCD with the brackets
  - removing 88

## M

- Main 113
- Main Unit Disassembly
  - Flowchart 55
- media access
  - on indicator 8
- Memory Check 97
- Menu
  - Boot 37
- menu
  - Exit 38
  - Information 29
  - Security 33
- Middle cover
  - removing 56
- Model Definition 214

## N

- Notebook Manager
  - hotkey 15
- notebook tour 7
- num lock
  - on indicator 8

## O

- Online Support Information 295

## P

- Panel
  - Bottom 11
- password
  - changing 35
  - removing 35
  - setting 34
- Power System Check 97
  - Battery Pack 98
  - Power Adapter 97
- Processor 19

## S

- Screw List 42
- speakers
  - hotkey 15
- System 4
  - Block Diagram 4
- System Check Procedures 96
- System Memory 20
- System Utilities 27

## T

- Test Compatible Components 291
- Touchpad Check 98
- Troubleshooting 95
- TV Tuner Board 48

## U

- Undetermined Problems 112
- utility
  - BIOS 27–39

## V

- view
  - left 9
  - rear 10
  - right 10
- view front 7

## W

- Windows 2000 Environment Test 292