

Aspire 5930/5930Z/5730Z Series Service Guide

Service guide files and updates are available on the ACER/CSD web; for more information, please refer to <http://csd.acer.com.tw>

PRINTED IN TAIWAN

Revision History

Please refer to the table below for the updates made on Aspire 5930/5930Z/5730Z Series service guide.

Date	Chapter	Updates

Copyright

Copyright © 2008 by Acer Incorporated. All rights reserved. No part of this publication may be reproduced, transmitted, transcribed, stored in a retrieval system, or translated into any language or computer language, in any form or by any means, electronic, mechanical, magnetic, optical, chemical, manual or otherwise, without the prior written permission of Acer Incorporated.

Disclaimer

The information in this guide is subject to change without notice.

Acer Incorporated makes no representations or warranties, either expressed or implied, with respect to the contents hereof and specifically disclaims any warranties of merchantability or fitness for any particular purpose. Any Acer Incorporated software described in this manual is sold or licensed "as is". Should the programs prove defective following their purchase, the buyer (and not Acer Incorporated, its distributor, or its dealer) assumes the entire cost of all necessary servicing, repair, and any incidental or consequential damages resulting from any defect in the software.

Acer is a registered trademark of Acer Corporation.

Intel is a registered trademark of Intel Corporation.

Pentium and Pentium II/III are trademarks of Intel Corporation.

Other brand and product names are trademarks and/or registered trademarks of their respective holders.

Conventions

The following conventions are used in this manual:

SCREEN MESSAGES	Denotes actual messages that appear on screen.
NOTE	Gives bits and pieces of additional information related to the current topic.
WARNING	Alerts you to any damage that might result from doing or not doing specific actions.
CAUTION	Gives precautionary measures to avoid possible hardware or software problems.
IMPORTANT	Reminds you to do specific actions relevant to the accomplishment of procedures.

Preface

Before using this information and the product it supports, please read the following general information.

1. This Service Guide provides you with all technical information relating to the BASIC CONFIGURATION decided for Acer's "global" product offering. To better fit local market requirements and enhance product competitiveness, your regional office MAY have decided to extend the functionality of a machine (e.g. add-on card, modem, or extra memory capability). These LOCALIZED FEATURES will NOT be covered in this generic service guide. In such cases, please contact your regional offices or the responsible personnel/channel to provide you with further technical details.
2. Please note WHEN ORDERING FRU PARTS, that you should check the most up-to-date information available on your regional web or channel. If, for whatever reason, a part number change is made, it will not be noted in the printed Service Guide. For ACER-AUTHORIZED SERVICE PROVIDERS, your Acer office may have a DIFFERENT part number code to those given in the FRU list of this printed Service Guide. You MUST use the list provided by your regional Acer office to order FRU parts for repair and service of customer machines.

Table of Contents

System Specifications	1
Features	1
System Block Diagram	4
Your Acer Notebook tour	5
Right View	8
Indicators	12
Easy-Launch Buttons	12
Touchpad Basics (with fingerprint reader)	13
Touchpad basics (with two-click buttons)	13
Using the Keyboard	15
Lock Keys and embedded numeric keypad	15
Windows Keys	16
Hot Keys	17
Special Key (only for certain models)	18
Acer Empowering Technology	19
Launching Acer Empowering Technology	19
Empowering Technology password	20
Acer eAudio Management (only for certain models)	21
Acer ePower Management	22
Acer eDataSecurity Management (only for certain models)	23
Acer eRecovery Management	24
Acer eSettings Management	26
Windows Mobility Center	27
Using the System Utilities	28
Acer GridVista (dual-display compatible)	29
Hardware Specifications and Configurations	31
System Utilities	39
BIOS Setup Utility	39
Navigating the BIOS Utility	40
Information	41
Main	42
Security	44
Intel	48
Boot	49
Exit	50
BIOS Flash Utility	51
Remove HDD/BIOS Utility	52
Machine Disassembly and Replacement	57
Disassembly Requirements	57
General Information	58
Pre-disassembly Instructions	58
Disassembly Process	58
External Module Disassembly Process	59
External Modules Disassembly Flowchart	59
Removing the Battery Pack	60
Removing the SD dummy card	61
Removing the ExpressCard dummy card	61
Removing the Lower Cover	62
Removing the DIMM	63
Removing the WLAN Board Modules	63
Removing the TV Tuner Board Modules	64
Removing the Modem Board	65

Table of Contents

Removing the Hard Disk Drive Module	66
Removing the Optical Drive Module	68
Main Unit Disassembly Process	71
Main Unit Disassembly Flowchart	71
Removing the Keyboard	72
Removing the Middle Cover	73
Removing the Power Board	74
Removing the Heatsink Fan Module	75
Removing the CPU and VGA Heatsink Module	76
Removing the CPU	77
Removing the VGA Board (Discrete Model only)	78
Removing the LCD Module	79
Separating the Upper Case from the Lower Case	81
Removing the Media Board	85
Removing the E-key Board	87
Removing the Speaker Module	89
Removing the Launch Board	90
Removing the Fingerprint and Touchpad Module	91
Removing the Main Board	94
Removing the USB Board Module	97
Removing the Audio Board Module	98
Removing the Subwoofer and the Bluetooth Modules	100
LCD Module Disassembly Process	102
LCD Module Disassembly Flowchart	102
Removing the LCD Bezel	103
Removing the LCD module with the Brackets	104
Removing the FPC Cable	106
Removing the LCD Brackets	107
Removing the Antennas	108
Removing the Web Camera	109
Troubleshooting	111
System Check Procedures	112
External Diskette Drive Check	112
External CD-ROM Drive Check	112
Keyboard or Auxiliary Input Device Check	112
Memory check	113
Power System Check	113
Touchpad Check	115
Power-On Self-Test (POST) Error Message	116
Index of Error Messages	117
Phoenix BIOS Beep Codes	120
Index of Symptom-to-FRU Error Message	125
Intermittent Problems	129
Undetermined Problems	130
Jumper and Connector Locations	131
Top and Bottom View	131
Clearing Password Check and BIOS Recovery	133
Clearing Password Check	133
BIOS Recovery by Crisis Disk	134
FRU (Field Replaceable Unit) List	135
Aspire 5930/5930Z/5730Z Series Exploded Diagram	136
Aspire 5930/5930Z/5730Z Series	146

Table of Contents

Model Definition and Configuration	146
Test Compatible Components	169
Microsoft® Windows® Vista Environment Test	170
Online Support Information	173
Index	175

Table of Contents

System Specifications

Features

Below is a brief summary of the computer's many features:

Platform

Intel® Centrino® 2 processor technology, featuring:

- Intel® Core™2 Duo processor
- Mobile Intel® PM45/GM45 Express Chipset*
- Intel® Wireless WiFi Link 5100/5300*, 5150/5350 (Subject to availability)
- Intel® Pentium® Core processor*
- Mobile Intel® GM45 Express Chipset*
- Acer InviLink™ Nplify™ 802.11b/g/Draft-N*
- Acer InviLink™ 802.11b/g*

System Memory

- Dual-Channel DDR2 SDRAM support
- Up to 2 GB of DDR2 667 MHz memory, upgradeable to 4 GB using two soDIMM modules*

Display and graphics

- 15.4" WXGA 1280 x 800
- Mobile Intel® GM45 Express Chipset (Intel® GMA X4500HD)*
- NVIDIA® GeForce® 9300M GS/9600M GT*
- Digital TV-tuner supporting DVB-T*

Storage subsystem

- 2.5" hard disk drives
- Optical drive options:
 - ▶ Blu-ray Disc™/DVD-Super Multi double-layer drive
 - ▶ DVD-Super Multi double-layer drive
- 5-in-1 card reader

Special keys and controls

- 88-/89-/93-key keyboard
- Touchpad pointing device
- Empowering Key
- Easy-launch buttons: WLAN, Internet, email, Bluetooth, Acer Arcade™
- Acer MediaTouch keys: play/pause, stop, previous, next
- Volume wheel
- Acer Media Center remote control*

Audio

- Dolby®-certified surround sound system with two built-in stereo speakers and one subwoofer supporting low-frequency effects
- S/PDIF (Sony/Philips Digital Interface) support for digital speakers
- Acer PureZone technology with two built-in stereo microphones

Communication

- Acer Video Conference, featuring:
 - ▶ Integrated Acer Crystal Eye webcam
 - ▶ Acer Video Conference Manager software
 - ▶ Acer PureZone technology
 - ▶ Optional Acer Xpress VoIP phone
- WLAN:
 - ▶ Intel® Wireless WiFi Link 5100/5300*
 - ▶ Acer InViLink™ Nplify™ 802.11b/g/Draft-N*
 - ▶ Acer InViLink™ 802.11b/g*
- WiFi/WiMAX™: Intel® Wireless WiFi Link 5150/5350 (Subject to availability)
- WPAN: Bluetooth® 2.0+EDR (Enhanced Data Rate)
- LAN: Gigabit Ethernet; Wake-on-LAN ready
- Modem: 56K ITU V.92

I/O Ports

- Acer EasyPort IV connector
- (for Aspire 5930 series only)
- ExpressCard™/54 slot
- 5-in-1 card reader (SD/MMC/MS/MS PRO/xD)
- 4 USB 2.0 ports
- HDMI™ port with HDCP support*
- USB 2.0/ eSATA port *

NOTE: If you plug an eSATA device you will have three USB ports available in the mean time.

- Consumer infrared (CIR) port
- External display (VGA) port
- RF-in jack (for Aspire 5930 series only)
- Headphones/speaker/line-out jack with S/PDIF support*
- Microphone-in jack
- Line-in jack
- Ethernet (RJ-45) port
- Modem (RJ-11) port
- DC-in jack for AC adapter

Environment

- Temperature:
 - ▶ Operating: 5 °C to 35 °C
 - ▶ Non-operating: -20 °C to 65 °C
- Humidity (non-condensing):
 - ▶ Operating: 20% to 80%

✦ Non-operating: 20% to 80%

NOTE: "*" "Only for certain models"

NOTE: The specifications listed above are for reference only. The exact configuration of your PC depends on the model purchased.

System Block Diagram

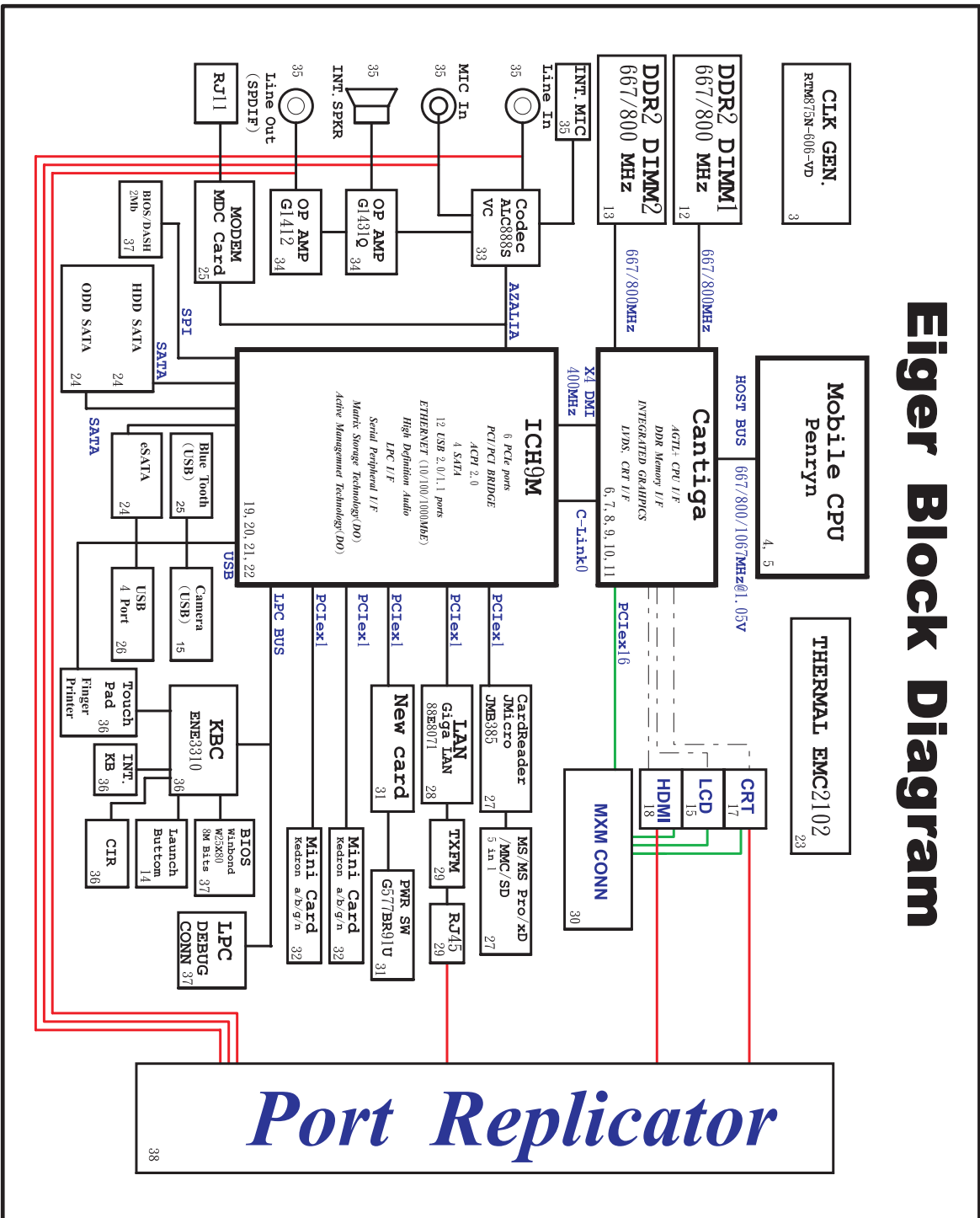



Your Acer Notebook tour

After knowing your computer features, let us show you around your new computer.

Front View



	Icon	Item	Description
1		Acer PureZone	Two internal stereo microphones for sound recording.
2		Acer Crystal Eye	Web camera for video communication.
3		Display screen	Also called Liquid-Crystal Display (LCD), displays computer output.
4		Power button	Turns the computer on and off.
5		Speakers	Left and right speakers deliver stereo audio output.
6		Easy-launch buttons	Buttons for launching frequently used programs.
7		Keyboard	For entering data into your computer.
8		Palmrest	Comfortable support area for your hands when you use the computer.

	Icon	Item	Description
9		Touchpad	Touch-sensitive pointing device which functions like a computer mouse.
10		Click buttons (left, center* and right)	The left and right buttons function like the left and right mouse buttons. *The center button serves as Acer Bio-Protection fingerprint reader supporting Acer FingerNav 4-way control function (only for certain models).
11/12		Status indicators	Light-Emitting Diodes (LEDs) that light up to show the status of the computer's functions and components.
13		Empowering key	Launch Acer Empowering Technology
14		Acer MediaTouch keys	For use with Acer Arcade and other media playing programs.



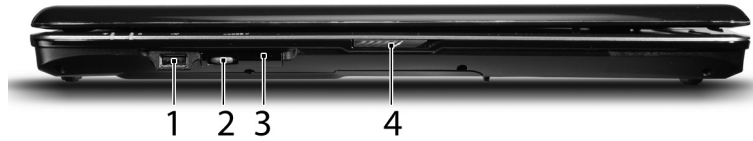



Closed Front View

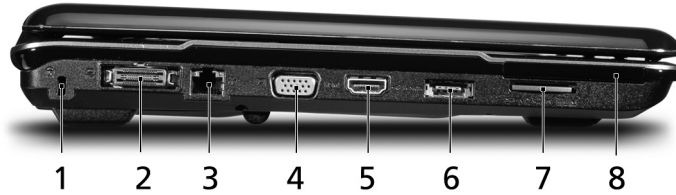

	Icon	Item	Description
1		USB 2.0 ports	Connect to USB 2.0 devices (e.g., USB mouse, USB camera) (only for certain models).
2		Unlimited volume control wheel	Adjust the volume of the audio-out.
3		CIR receiver	Receives signals from a remote control.
4		Latch	Locks and releases the lid.
1		Speakers	Left and right speakers deliver stereo audio output.
2		4-pin IEEE 1394 port	Connects to IEEE 1394 devices.
3		Line-in jack	Accepts audio line-in devices (e.g., audio CD player, stereo walkman).
4		Microphone-in jack	Accepts input from external microphones.
5		Headphones/speaker/line-out jack with S/PDIF support	Connects to audio line-out devices (e.g., speakers, headphones).
6		Bluetooth communication switch	Enable/disables the Bluetooth function.
7		Wireless communication switch	Enable/disables the wireless function.
8		Infrared port	Interfaces with infrared devices (e.g., infrared printer and IR-aware computer).

Left View







#	Icon	Item	Description
1		Kensington lock slot	Connects to a Kensington-compatible computer security lock.
2		Acer EasyPort IV connector	Connects to Acer EasyPort IV (for Aspire 5930 series only).
3		Ethernet (RJ-45) port	Connects to an Ethernet 10/100/1000-based network.
4		External display (VGA) port	Connects to a display device (e.g., external monitor, LCD projector).
5	HDMI	HDMI	Connects to a television or display device with HDMI input.
6		USB 2.0/ eSATA port	Connects to USB 2.0 or eSATA devices (only for certain models). Note: If you plug an eSATA device you will have three USB ports available in the mean time.
7		5-in-1 card reader	Accepts Secure Digital (SD), MultiMediaCard (MMC), Memory Stick (MS), Memory Stick PRO (MS PRO), xD-Picture Card (xD).
8	ExpressCard / 54	ExpressCard/54 slot	Accepts one ExpressCard/54 module.

Right View



	Icon	Item	Description
1		Line-in jack	Accepts audio line-in devices (e.g., audio CD player, stereo walkman).

	Icon	Item	Description
		Microphone-in jack	Accepts input from external microphones.
		Headphones/speaker/ line-out jack with S/PDIF support	Connects to audio line-out devices (e.g., speakers, headphones).
2		Optical drive	Internal optical drive; accepts CDs or DVDs.
3		Optical disk access indicator	Lights up when the optical drive is active.
4		Optical drive eject button	Ejects the optical disk from the drive.
5		Emergency eject hole	Ejects the optical drive tray when the computer is turned off. Note: Insert a paper clip to the emergency eject hole to eject the optical drive tray when the computer is off.
6		USB 2.0 port	Connect to USB 2.0 devices (e.g., USB mouse, USB camera).
7		RF-in port	Accepts input signals from digital TV-tuner devices (for Aspire 5930 series only).
8		Modem (RJ-11) port	Connects to a phone line.





Rear View

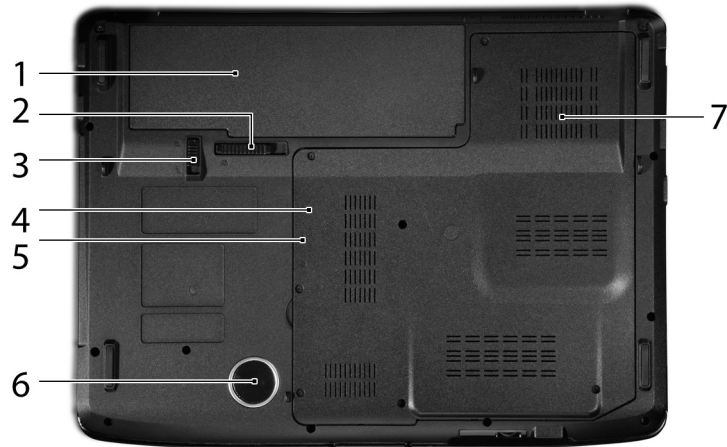

#	Icon	Item	Description
1		DC-in jack	Connects to an AC adapter.
2		Ventilation slots	Enable the computer to stay cool, even after prolonged use.





Bottom View



	Icon	Item	Description
1		Battery bay	Houses the computer's battery pack.
2		Battery release latch	Releases the battery for removal.
3		Battery lock	Locks the battery in position.
4		Memory compartment	Houses the computer's main memory.
5		Hard disk bay	Houses the computer's hard disk (secured with screws).
6		Sub woofer	Emits low frequency sound output (for Aspire 5930 series only).
7		Ventilation slots and cooling fan	Enable the computer to stay cool, even after prolonged use. Note: Do not cover or obstruct the opening of the fan.

Indicators

The computer has several easy-to-read status indicators. The front panel indicators are visible even when the computer cover is closed.







Icon	Function	Description
	HDD	Indicates when the hard disk drive is active.
	Num Lock	Lights up when Num Lock is activated.
	Caps Lock	Lights up when Caps Lock is activated.
	Power	Indicates the computer's power status.
	Battery	Indicates the computer's battery status.

NOTE: 1. **Charging:** The light shows amber when the battery is charging. 2. **Fully charged:** The light shows green when in AC mode.

Easy-Launch Buttons

Located beside the keyboard are application buttons. These buttons are called easy-launch buttons. They are: WLAN, Internet, email, Bluetooth, Arcade and Acer Empowering Technology.

The mail and Web browser buttons are pre-set to email and Internet programs, but can be reset by users. To set the Web browser, mail and programmable buttons, run the Acer Launch Manager. You can access the Launch Manager by clicking on Start, All Programs, and then Launch Manager to start the application.

Icon	Function	Description
	Wireless communication button/indicator (manufacturing option)	Enables/disables the wireless function. Indicates the status of wireless LAN communication.
	Web browser	Internet browser (user-Programmable)
	Mail	Email application (user-Programmable)
	Bluetooth communication button/indicator (manufacturing option)	Enables/disables the Bluetooth function. Indicates the status of Bluetooth communication.
	Arcade	Launch Acer Arcade utility (only for certain models).
	Acer Empowering Technology	Launch Acer Empowering Technology (user-programmable)

Touchpad Basics (with fingerprint reader)

The following items show you how to use the touchpad with Acer Bio-Protection fingerprint reader.

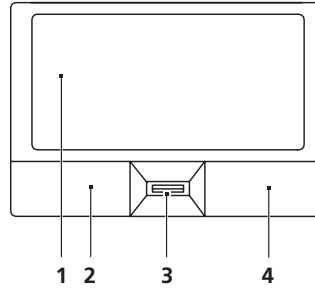

- ❑ Move your finger across the touchpad (2) to move the cursor.
- ❑ Press the left (1) and right (4) buttons located beneath the touchpad to perform selection and execution functions. These two buttons are similar to the left and right buttons on a mouse. Tapping on the touchpad is the same as clicking the left button.
- ❑ Use Acer Bio-Protection fingerprint reader (3) supporting Acer FingerNav 4-way control function (only for certain models) to scroll up or down and move left or right a page. This fingerprint reader or button mimics your cursor pressing on the right scroll bar of Windows applications.

Function	Left button (1)	Right button (4)	Main touchpad (2)	Center button (3)
Execute	Quickly click twice.		Tap twice (at the same speed as double-clicking a mouse button).	
Select	Click once.		Tap once.	
Drag	Click and hold, then use finger on the touchpad to drag the cursor.		Tap twice (at the same speed as double-clicking a mouse button); rest your finger on the touchpad on the second tap and drag the cursor.	
Access context menu		Click once.		
Scroll				Swipe up/down/left/right using Acer FingerNav 4-way control function (Manufacturing option).

Touchpad basics (with two-click buttons)

The following items show you how to use the touchpad with two-click buttons.

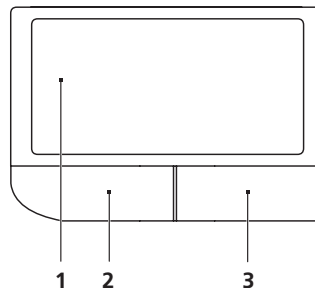

- ❑ Move your finger across the touchpad (1) to move the cursor.

-
- ❑ Press the left **(2)** and right **(3)** buttons located beneath the touchpad to perform selection and execution functions. These two buttons are similar to the left and right buttons on a mouse. Tapping on the touchpad is the same as clicking the left button.

Function	Left button (2)	Right button (3)	Main touchpad (1)
Execute	Quickly click twice.		Tap twice (at the same speed as double-clicking a mouse button).
Select	Click once.		Tap once.
Drag	Click and hold, then use finger on the touchpad to drag the cursor.		Tap twice (at the same speed as double-clicking a mouse button); rest your finger on the touchpad on the second tap and drag the cursor.
Access context menu		Click once.	

NOTE: Illustrations for reference only. The exact configuration of your PC depends on the model purchased.

NOTE: When using the touchpad, keep it — and your fingers — dry and clean. The touchpad is sensitive to finger movement; hence, the lighter the touch, the better the response. Tapping harder will not increase the touchpad's responsiveness.

NOTE: By default, vertical and horizontal scrolling is enabled on your touchpad. It can be disabled under Mouse settings in Windows Control Panel.

Using the Keyboard

The keyboard has full-sized keys and an embedded numeric keypad, separate cursor, lock, Windows, function and special keys.

Lock Keys and embedded numeric keypad

The keyboard has three lock keys which you can toggle on and off.



















Lock key	Description
Caps Lock	When Caps Lock is on, all alphabetic characters typed are in uppercase.
Num Lock <Fn> + <F11>	When Num Lock is on, the embedded keypad is in numeric mode. The keys function as a calculator (complete with the arithmetic operators +, -, *, and /). Use this mode when you need to do a lot of numeric data entry. A better solution would be to connect an external keypad. NOTE: <Fn> + <F11> works only for certain models.
Scroll Lock <Fn> + <F12>	When Scroll Lock is on, the screen moves one line up or down when you press the up or down arrow keys respectively. Scroll Lock does not work with some applications.

The embedded numeric keypad functions like a desktop numeric keypad. It is indicated by small characters located on the upper right corner of the key caps. To simplify the keyboard legend, cursor-control key symbols are not printed on the keys.

Desired access	Num Lock on	Num Lock off
Number keys on embedded keypad	Type numbers in a normal manner.	
Cursor-control keys on embedded keypad	Hold <Shift> while using cursor-control keys.	Hold <Fn> while using cursor-control keys.
Main keyboard keys	Hold <Fn> while typing letters on embedded keypad.	Type the letters in a normal manner.

Windows Keys









The keyboard has two keys that perform Windows-specific functions.

Key	Description
 Windows key	<p>Pressed alone, this key has the same effect as clicking on the Windows Start button; it launches the Start menu.</p> <p>It can also be used with other keys to provide a variety of functions:</p> <ul style="list-style-type: none"> <  >: Open or close the Start menu <  > + <D>: Display the desktop <  > + <E>: Open Windows Explore <  > + <F>: Search for a file or folder <  > + <G>: Cycle through Sidebar gadgets <  > + <L>: Lock your computer (if you are connected to a network domain), or switch users (if you're not connected to a network domain) <  > + <M>: Minimizes all windows <  > + <R>: Open the Run dialog box <  > + <T>: Cycle through programs on the taskbar <  > + <U>: Open Ease of Access Center <  > + <X>: Open Windows Mobility Center <  > + <BREAK>: Display the System Properties dialog box <  > + <SHIFT+M>: Restore minimized windows to the desktop <  > + <TAB>: Cycle through programs on the taskbar by using Windows Flip 3-D <  > + <SPACEBAR>: Bring all gadgets to the front and select Windows Sidebar <CTRL> + <  > + <F>: Search for computers (if you are on a network) <CTRL> + <  > + <TAB>: Use the arrow keys to cycle through programs on the taskbar by using Windows Flip 3-D <p>Note: Depending on your edition of Windows Vista, some shortcuts may not function as described.</p>
 Application key	<p>This key has the same effect as clicking the right mouse button; it opens the application's context menu.</p>

Hot Keys

The computer employs hotkeys or key combinations to access most of the computer's controls like screen brightness, volume output and the BIOS utility.

To activate hot keys, press and hold the <Fn> key before pressing the other key in the hotkey combination.

Hotkey	Icon	Function	Description
<Fn> + <F1>	?	Hotkey help	Displays help on hotkeys.
<Fn> + <F2>		Acer eSettings	Launches Acer eSettings in Acer Empowering Technology.
<Fn> + <F3>		Acer ePower Management	Launches Acer ePower Management in Acer Empowering Technology.
<Fn> + <F4>	Z ^z	Sleep	Puts the computer in Sleep mode.
<Fn> + <F5>		Display toggle	Switches display output between the display screen, external monitor (if connected) and both.
<Fn> + <F6>		Screen blank	Turns the display screen backlight off to save power. Press any key to return.
<Fn> + <F7>		Touchpad toggle	Turns the internal touchpad on and off.
<Fn> + <F8>		Speaker toggle	Turns the speakers on and off.
<Fn> + <↑>		Brightness up	Increases the screen brightness.
<Fn> + <↓>		Brightness down	Decreases the screen brightness.
<Fn> + <△>		Volume up	Increases the sound volume (only for certain models).
<Fn> + <▽>		Volume down	Decreases the sound volume (only for certain models).

Special Key (only for certain models)

You can locate the Euro symbol and the US dollar sign at the upper-center and/or bottom-right of your keyboard.

The Euro symbol

1. Open a text editor or word processor.
2. Either press < € > at the bottom-right of the keyboard, or hold <Alt Gr> and then press the <5> key at the upper-center of the keyboard.

NOTE: Some fonts and software do not support the Euro symbol. Please refer to www.microsoft.com/typography/faq/faq12.htm for more information.

The US dollar sign

1. Open a text editor or word processor.
2. Either press < \$ > at the bottom-right of the keyboard, or hold <Shift> and then press the <4> key at the upper-center of the keyboard.

NOTE: This function varies according to the language settings.

Acer Empowering Technology

The Empowering Technology toolbar makes it easy for you to access frequently used functions and manage your new Acer system. Activated by pressing the Empowering Key, it provides access to the following utilities:

NOTE: The following content is for general reference only. Actual product specifications may vary.



- ❑ **Acer eAudio Management** allows you to easily control the enhanced sound effects of Dolby Home Theater on your system (only for certain models).
- ❑ Acer ePower Management optimizes battery usage via customizable power plans.
- ❑ **Acer eDataSecurity Management** protects data with passwords and encryption (only for certain models).
- ❑ **Acer eRecovery Management** backs up and recovers data flexibly, reliably and completely.
- ❑ **Acer eSettings Management** accesses system information and adjusts settings easily.



For more information, right-click on the Empowering Technology toolbar, then select **Help**. For help with a particular utility, launch the utility and click the  icon at the bottom of the active window.

Launching Acer Empowering Technology

To launch Acer Empowering Technology:

1. Press the Empowering Key to display the Acer Empowering Technology toolbar on the desktop.
2. To hide the toolbar, press the Empowering Key again or click the hide button  on the toolbar. You may also launch Acer Empowering Technology by running the program from the Acer Empowering Technology program group in the Start menu, or by double-clicking the  icon if you have created a desktop shortcut.

To launch Acer Empowering Technology applications:

1. On the Acer Empowering Technology toolbar, click the icon that corresponds to the application you want to launch.
2. When you mouse over an application icon, a quick menu appears below the toolbar. The quick menu allows you to perform certain tasks simply and quickly.

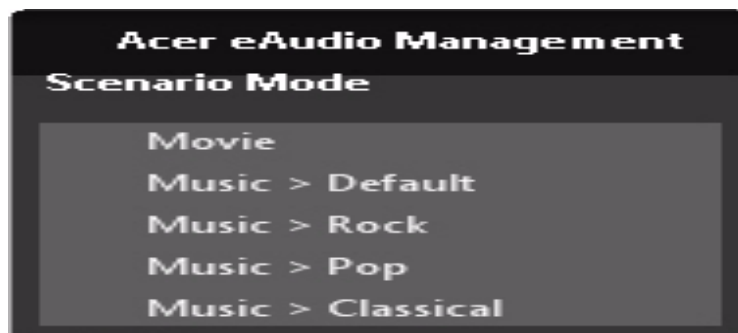

3. You may also run the application by selecting it from the Acer Empowering Technology program group in the Start menu.

NOTE: You may also double-click or right-click  to run Acer eAudio Management, and right-click  to run Acer ePower Management from the system tray.

Empowering Technology password

You must set the Empowering Technology password to use the password protection feature of Acer eRecovery Management to protect your data.

To set the Empowering Technology password:

1. Launch Acer eRecovery Management.
2. Click the Restore tab.
3. Click **Password settings**. The Empowering Technology Password Center dialogue box pops up.
4. Click **Create a new password**.

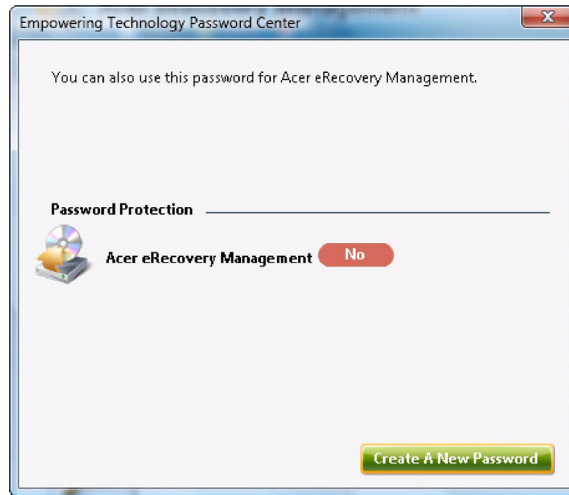

5. In the Create a New Password dialogue box, key in and confirm your password in the appropriate boxes. Your password should have a minimum of 4 and a maximum of 12 characters.
6. Enter a password hint that will help you remember your password.
7. Make sure the box **Use for Acer eRecovery Management** is checked.
8. Click **OK** to set the password.



Acer eAudio Management (only for certain models)

Acer eAudio Management allows you to easily control the enhanced sound effects of Dolby Home Theater on your system. Select **Movie** or **Game** mode to experience the awesome realism of 5.1-channel audio output from the speakers fitted to your system via Dolby Surround sound technology. **Music** mode lets you enjoy your favorite tunes, in vivid detail.



To choose your playback device, click the  icon on the upper right side of the Acer eAudio Management window.

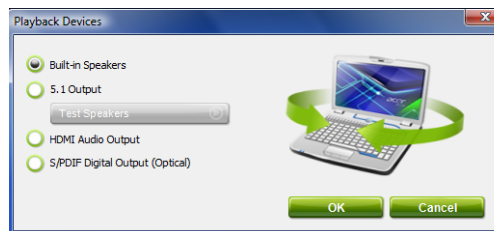

Acer ePower Management

Acer ePower Management features a straightforward user interface for configuring your power management options. To access this utility, select **Acer ePower Management** from the Empowering Technology toolbar, run the program from the Acer Empowering Technology program group in Start menu, or right-click the Windows power icon in the system tray and select **Acer ePower Management**.

Using power plans

Acer ePower Management comes with three predefined power plans: **Balanced**, **High performance** and **Power saver**.

View and adjust settings for **On Battery** and **Plugged In** modes by clicking the appropriate tabs. For more power options, click  in the Acer ePower Management utility, or right-click the Windows power icon in the system tray and select **Power Options**.

You can also create customized power plans. You can create, switch between, edit, delete and restore power plans, as described below.

To create a new power plan:

Creating customized power plans allows you to save and quickly switch to a personalized set of power options.

1. Click the **New power plan** option or icon .
2. Enter a name for your new power plan.
3. Choose a predefined power plan to base your customized plan on.
4. If necessary, change the display, sleep and hibernation settings you want your computer to use.
5. Click **OK** to save your new power plan.

To switch between power plans:

1. Move your mouse over the Acer ePower Management  application on the Acer Empowering Technology toolbar. The quick menu appears. Select the power plan you want to switch to.
2. You may also switch between power plans by launching the Acer ePower Management application. Select the power plan you wish to switch to, then click **Apply**.

To edit a power plan:

Editing a power plan allows you to adjust system settings like LCD brightness, CPU speed and Graphics power mode (only for certain models).

1. Switch to the power plan you wish to edit.
2. Adjust settings as required.
3. Click **Apply** or **Save** to save your new settings.

NOTE: You can revert to the default settings of the predefined power plans by clicking the **Restore** button.

To delete a power plan:

You cannot delete the power plan you are currently using. The active power plan will mark with  in upper left corner of power plan icon. If you want to delete the active power plan, switch to another one first.

1. Select the power plan you wish to delete.
2. Click the Delete this plan icon. 

NOTE: You cannot delete the predefined power plans, but you can modify the settings of the predefined power plans.

Battery status

1. The quick menu shows the remaining battery life based on current usage.
2. You can also launch the Acer ePower Management application and refer to the Battery status panel located just below the power plans.
3. Click the Battery tab to view remaining battery life, battery status, and remaining battery life in standby and hibernate modes.



Acer eDataSecurity Management (only for certain models)

Acer eDataSecurity Management is an encryption utility that protects your files from being accessed by unauthorized persons. It is conveniently integrated with Windows Explorer as a shell extension for quick data encryption/decryption and also supports on-the-fly file encryption for Lotus Notes and Microsoft Outlook.

On first use, the Acer eDataSecurity Management setup wizard will prompt you to create the Master Password. You will use this password to access the Personal Secure Disk (PSD). The Master Password may also be used to encrypt/decrypt files by default.

If you set a different password to encrypt a file, but you forgot the encryption password, you can use the Master Password to decrypt the file.

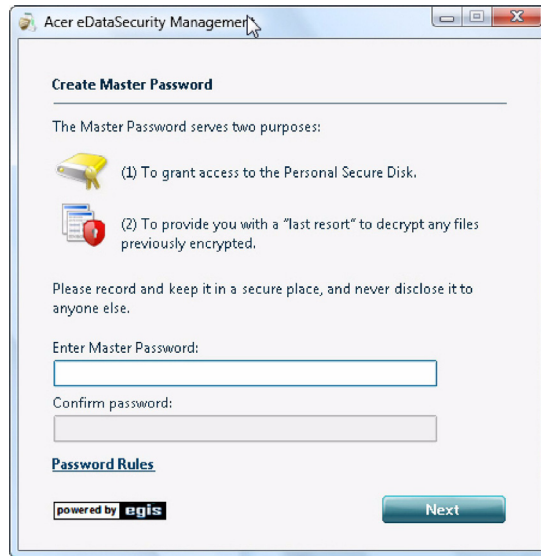

NOTE: The password used to encrypt a file is the unique key that the system needs to decrypt it. If you lose the password, the Master Password is the only other key capable of decrypting the file. If you lose both passwords, there will be no way to decrypt your encrypted file! **Be sure to safeguard all related passwords!**



Acer eRecovery Management

Acer eRecovery Management is a versatile backup utility. It allows you to create full or incremental backups, burn the factory default image to optical disc, and restore from previously created backups or reinstall applications and drivers. By default, user-created backups are stored to the D:\ drive.

Acer eRecovery Management provides you with:

- Backup:

-
- ✦ Back up factory default to CD/DVD
 - ✦ Back up drivers and applications to CD/DVD
 - ✦ Create user backup
 - ✦ Manage user backups
- Restore:
- ✦ Restore system to factory default
 - ✦ Reinstall applications/drivers
 - ✦ Restore system from user backup
 - ✦ Password settings

To use the password protection feature of Acer eRecovery Management to protect your data, you must first set the Empowering Technology password. To set the password, refer to the section "**Empowering Technology password**".

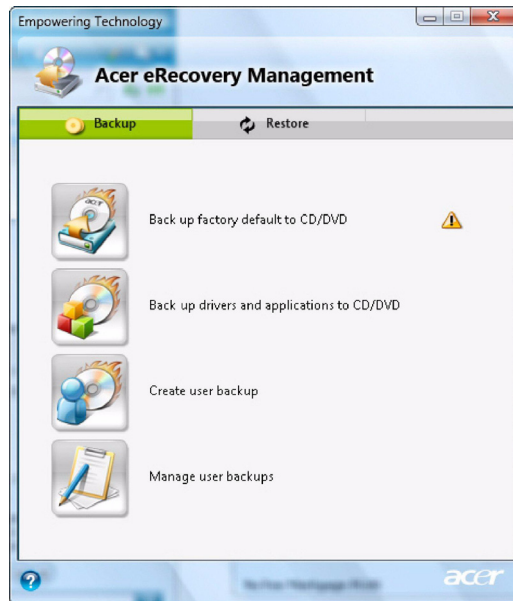

For more information, please refer to "**Acer eRecovery Management**" on page 62 in the **Acer System User's Guide**.

NOTE: If your computer did not come with a Recovery CD or System CD, please use Acer eRecovery Management's Backup factory default to CD/DVD feature to burn a backup image to CD or DVD. To ensure the best results when recovering your system using a CD or Acer eRecovery Management, detach all peripherals (except the external Acer ODD, if your computer has one), including your Acer ezDock.

Acer eSettings Management

Acer eSettings Management allows you to inspect hardware specifications, set BIOS passwords and modify boot options.

Acer eSettings Management also:

- Provides a simple graphical user interface for navigation.
- Prints and saves hardware specifications.
- Lets you set an asset tag for your system.

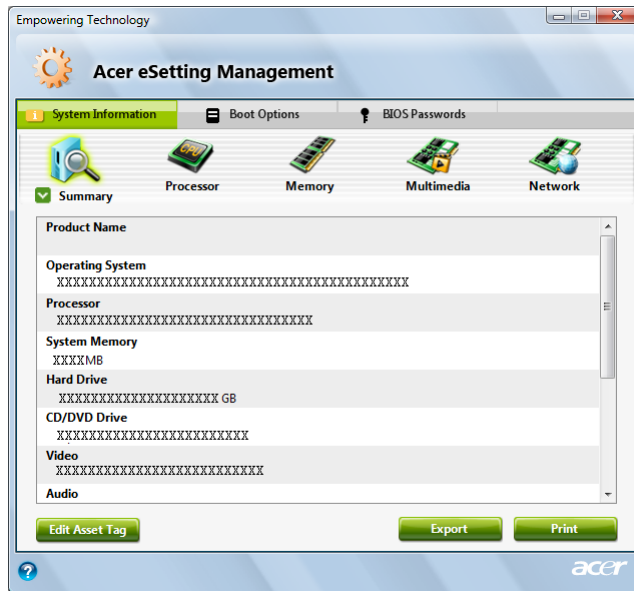

Windows Mobility Center

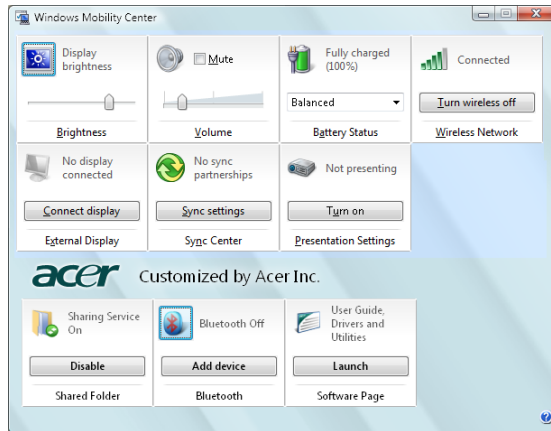

The Windows Mobility Center collects key mobile-related system settings in one easy-to-find place, so you can quickly configure your Acer system to fit the situation as you change locations, networks or activities. Settings include display brightness, volume, power plan, wireless networking on/off, external display settings, synchronization status and presentation settings.

Windows Mobility Center also includes Acer-specific settings like sharing folders overview/sharing service on or off, Bluetooth Add Device (if applicable), and a shortcut to the Acer user guide, drivers and utilities.

To launch Windows Mobility Center:

- Use the shortcut key + <X>.
- Start Windows Mobility Center from the Control panel.
- Start Windows Mobility Center from the Accessories program group in the Start menu.
- Launch Windows Mobility Center by right-clicking  in the system tray and select **Windows Mobility Center**.

Using the System Utilities

Acer Bio-Protection (only for certain models)

Acer Bio-Protection Fingerprint Solution is a multi-purpose fingerprint software package integrated with the Microsoft Windows operating system. Utilizing the uniqueness of one's fingerprint features, Acer Bio-Protection Fingerprint Solution has incorporated protection against unauthorized access to your computer with centralized password management with Password Bank, easy music player launching with Acer MusicLaunch, secure Internet favorites via Acer MyLaunch, and fast application/website launching and login with Acer FingerLaunch, while Acer ProfileLaunch can launch up to three applications/websites from a single finger swipe.

Acer Bio-Protection Fingerprint Solution also allows you to navigate through web browsers and documents using Acer FingerNav. With Acer Bio-Protection Fingerprint Solution, you can now enjoy an extra layer of protection for your personal computer, as well as the convenience of accessing your daily tasks with a simple swipe of your finger!

For more information refer to the Acer Bio-Protection help files.

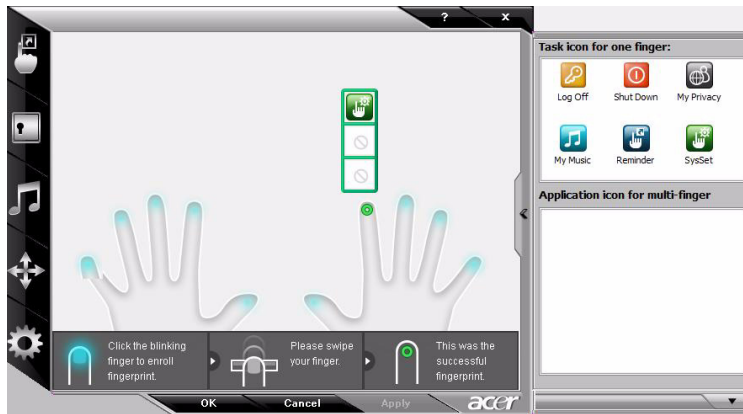

Acer GridVista (dual-display compatible)

NOTE: This feature is only available on certain models.

To enable the dual monitor feature of the notebook, first ensure that the second monitor is connected, then select **Start, Control Panel, Display** and click on **Settings**. Select the secondary monitor (**2**) icon in the display box and then click the check box **Extend my windows desktop onto this monitor**. Finally, click **Apply** to confirm the new settings and click **OK** to complete the process.

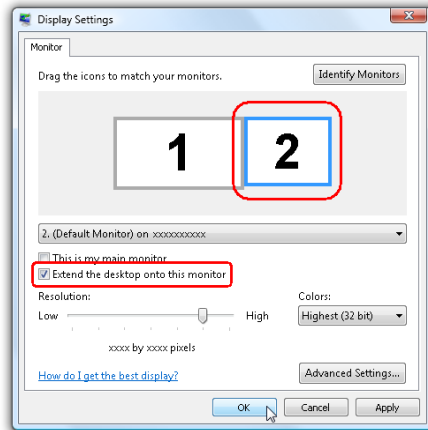

Acer GridVista is a handy utility that offers four pre-defined display settings so you can view multiple windows on the same screen. To access this function, please go to **Start>All Programs** and click on **Acer GridVista**. You may choose any one of the four display settings indicated below:

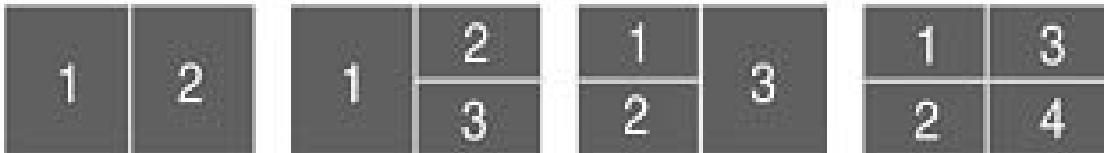

Double (vertical), Triple (primary at left), Triple (primary at right), or Quad Acer GridVista is dual-display compatible, allowing two displays to be partitioned independently.

Acer GridVista is dual-display compatible, allowing two displays to be partitioned independently.

AcerGridVista is simple to set up:

1. Run Acer GridVista and select your preferred screen configuration for each display from the task bar.
2. Drag and drop each window into the appropriate grid.
3. Enjoy the convenience of a well-organized desktop.

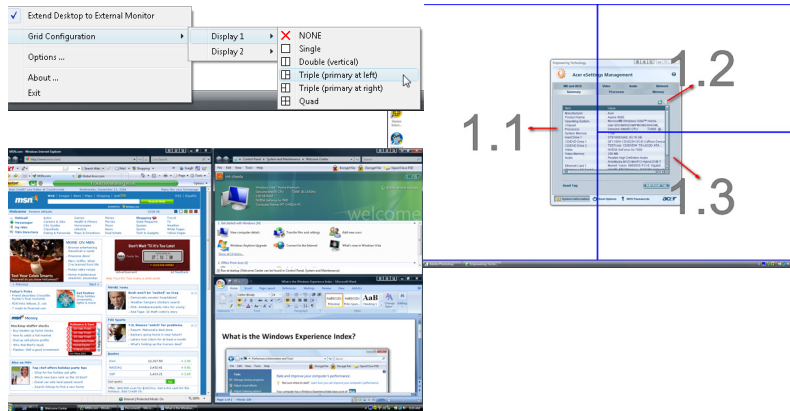

NOTE: Please ensure that the resolution setting of the second monitor is set to the manufacturer's recommended value.

Hardware Specifications and Configurations

Processor

Item	Specification
CPU type	Intel® Core™2 Duo Mobile Processor P8400 (2.26G), P8600 (2.4 G), P9500 (2.53G), T9400 (2.53G), T9600 (2.8G)
Core logic	Mobile Intel® 945 Express Chipset
CPU package	Socket B (P8400, P8600, P9500) and Socket P (T9400, T9600)
CPU core voltage	1.0375V to 1.3V

CPU Fan True Value Table

DTS(degree C)	Fan Speed (rpm)	Acoustic Level (dBA)
45-50	0-3000	29
55-66	0-3300	33
68-74	3300-3800	38
78-83	3800-4100	40
86-91	4100-4800	40

Throttling 50%: On= 99° C; OFF=93° C

OS shut down at 105° C; H/W shot down at 110° .C

BIOS

Item	Specification
BIOS vendor	Phoenix
BIOS Version	1.04c

System Memory

Item	Specification
Memory controller	Built-in
Memory size	0MB (no on-board memory)
DIMM socket number	2 sockets
Supports memory size per socket	2048MB
Supports maximum memory size	4G for 64bit OS (with two 2GB SODIMM)
Supports DIMM type	DDR 2 Synchronous DRAM
Supports DIMM Speed	667 MHz
Supports DIMM voltage	1.8V and 0.9V
Supports DIMM package	200-pin soDIMM
Memory module combinations	You can install memory modules in any combinations as long as they match the above specifications.

Memory Combinations

Slot 1	Slot 2	Total Memory
0MB	256MB	256MB
0MB	512MB	512MB
0MB	1024MB	1024MB
0MB	2048MB	2048MB
256MB	256MB	512MB
256MB	512MB	768MB
256MB	1024MB	1280MB
256MB	2048MB	2304MB
512MB	256MB	768MB
512MB	512MB	1024MB
512MB	1024MB	1536MB
512MB	2048MB	2560MB
1024MB	0MB	1024MB
1024MB	256MB	1280MB
1024MB	512MB	1536MB
1024MB	1024MB	2048MB
1024MB	2048MB	3072MB
2048MB	0MB	2048MB
2048MB	256MB	2304MB
2048MB	512MB	2560MB
2048MB	1024MB	3072MB
2048MB	2048MB	4096MB

NOTE: Above table lists some system memory configurations. You may combine DIMMs with various capacities to form other combinations. On above table, the configuration of slot 1 and slot 2 could be reversed.

Item	Specification
LAN Chipset	Broadcom BCM5764/Broadcom BCM5765
Supports LAN protocol	10/100/1000 Mbps
LAN connector type	RJ45
LAN connector location	Left side
Features	Integrated 10/100 BASE-T transceiver Wake on LAN support compliant with ACPI 2.0 PCI v2.2

Bluetooth Interface

Item	Specification
Chipset	Foxconn Bluetooth FOX_BRM_2.0 F/W 300
Data throughput	723 bps (full speed data rate)
Protocol	Bluetooth 1.1 (Upgradeable to Bluetooth 1.2 when SIG specification is ratified).
Interface	USB 1.1

Bluetooth Interface

Item	Specification
Connector type	USB

Wireless Module 802.11b/g

Item	Specification
Chipset	WLAN 802.11ABGN SHIRLEYPEAK1*2
Data throughput	11~54 Mbps, up to 270 Mbps for Draft-N
Protocol	802.11b+g, Draft-N
Interface	PCI bus (mini PCI socket for wireless module)

Hard Disk Drive Interface

Item				
Vendor & Model Name	HGST HTS542512K9SA00 BRONCO-B LF SEAGATE ST9120817AS LF TOSHIBA MK1246GSX LF WD1200BEVS- 22UST0 ML125 LF	WD1600BEVT- 22ZCT0 HITACHI HTS541616J9SA00 LF SEAGATE SATA ST9160827AS TOSHIBA MK1646GSX LF	SEAGATE SATA ST9250827AS TOSHIBA MK2546GSX LF HGST HTS542525K9SA00 LF WD WD2500BEVS- 22UST0 ML125	WD WD3200BEVT- 22ZCT0 ML125
Capacity (MB)	120000	160000	250000	320000
Bytes per sector	512	512	512	N/A
Data heads	3	3/4	4	N/A
Drive Format				
Disks	2	2	2	N/A
Spindle speed (RPM)	5400 RPM	5400 RPM	5400 RPM	5400 RPM
Performance Specifications				
Buffer size	8MB	8MB	8MB	8MB
Interface	SATA	SATA	SATA	SATA
Max. media transfer rate (disk-buffer, Mbytes/s)	540	540	540	850
DC Power Requirements				
Voltage tolerance	5V(DC) +/- 5%	5V(DC) +/- 5%	5V(DC) +/- 5%	5V(DC) +/- 5%

Optical Disc Drive

Item	Specification	
Vendor & model name	TOSHIBA SUPER-MULTI DRIVE DL 8X TS-L633A LF PIONEER SUPER-MULTI DRIVE 8X DVR-TD08RS LF PANASONIC SUPER-MULTI DRIVE DL 8X UJ-870A LF HLDS SUPER-MULTI DRIVE TRAY DL 8X GSA-T50N LF HLDS SUPER-MULTI DRIVE DL 8X GSA-T50N LF SONY SUPER-MULTI DRIVE DL 8X AD-7560S LF PLDS SUPER-MULTI DRIVE DL 8X DS-8A2S LF	
Performance Specification	With CD Diskette	With DVD Diskette
Transfer rate (KB/sec)	Sustained: Max 3.6Mbytes/sec	Sustained: Max 10.08Mbytes/sec
Buffer Memory	2MB	
Interface	SATA	
Applicable disc format	<p>Applicable disc format</p> <p>CD: CD-DA, CD-ROM, CD-ROM XA, Photo CD (multi-session), Video CD, Cd-Extra (CD+), CD-text</p> <p>DVD: DVD-VIDEO, DVD-ROM, DVD-R (3.9GB, 4.7GB) DVD-R DL, DVD-RW, DVD-RAM, DVD+R, DVD+R DL, DVD+RW</p> <p>CD:</p> <p>CD-DA (Red Book) - Standard Audio CD & CD-TEXT</p> <p>CD-ROM (Yellow Book Mode1 & 2) - Standard Data</p> <p>CD-ROM XA (Mode2 Form1 & 2) - Photo CD, Multi-Session</p> <p>CD-I (Green Book, Mode2 Form1 & 2, Ready, Bridge)</p> <p>CD-Extra/ CD-Plus (Blue Book) - Audio & Text/Video</p> <p>Video-CD (White Book) - MPEG1 Video</p> <p>CD-R (Orange Book Part)</p> <p>CD-RW & HSRW (Orange Book Part Volume1 & Volume 2)</p> <p>Super Audio CD (SACD) Hybrid type</p> <p>US & US+ RW</p> <p>DVD:</p> <p>DVD-ROM (Book 1.02), DVD-Dual</p> <p>DVD-Video (Book 1.1)</p> <p>DVD-R (Book 1.0, 3.9G)</p> <p>DVD-R (Book 2.0, 4.7G) - General & Authoring</p> <p>DVD+R (Version 1.0)</p> <p>DVD+RW</p> <p>DVD-RW (Non CPRM & CPRM)</p> <p>DVD²R Dual</p>	
Loading mechanism	<p>Load: Manual</p> <p>Release: (a) Electrical Release (Release Button)</p> <p style="padding-left: 40px;">(b) Release by ATAPI command</p> <p style="padding-left: 40px;">(c) Emergency Release</p>	
Power Requirement		
Input Voltage	5 V +/- 5% (Operating)	

Audio Interface

Item	Specification
Audio Controller	Realtek ALC883 Azalia and Amplifier Maxim MAX9710 & MAX4411
Audio onboard or optional	Built-in
Mono or Stereo	Stereo
Resolution	18 bit stereo full duplex
Compatibility	HD audio Interface; S/PDIF output for PCM or AC-3 content
Sampling rate	1Hz resolution VSR (Variable Sampling Rate)
Internal microphone	Yes
Internal speaker / Quantity	Yes/2 (1.5W speakers)

Video Memory

Item	Specification
Chipset	VGA CARD NB9P-GS/Intel GMA970 VGA
Memory size	512M GDDR3/

Item	Specification
Chipset	ICH8M
USB Compliancy Level	2.0
OHCI	USB 1.1 and USB 2.0 Host controller
Number of USB port	3
Location	Two on the right side/one on the front
Serial port function control	Enable/Disable by BIOS Setup

System Board Major Chips

Item	Controller
Core logic	Mobile Intel® GM945/PM945 + ICH8M Express Chipset
VGA	nVidia GeForce 9300 GS/9600M GT/UMA
USB 2.0	Intel ICH8M
Super I/O controller	N/A
MODEM	ALC 883
Bluetooth	FOXCONN BCM2045 V2
Wireless 802.11 b+g	WLAN 802.11ABGN SHIRLEYPEAK1*2
PCMCIA/ 5 in 1 Card Reader	JMicron Cardreader JMB385
Audio Codec	Audio Azalia(ALC888S)

Keyboard

Item	Specification
Keyboard controller	NS PC97541V

Keyboard

Item	Specification
Total number of keypads	84-/85-key
Windows logo key	Yes
Internal & external keyboard work simultaneously	Plug USB keyboard to the USB port directly: Yes

Battery

Item	Specification
Vendor	Panasonic/Sanyo/Sony/Simplo
Battery Type	Li-ion
Pack capacity	6Cell 4400 MAH/8Cell 4800 MAH
Number of battery cell	6/8
Package configuration	3 cells in series, 2 series in parallel 4 cells in series, 2 series in parallel

LCD 15.4" inch

Item	Specification
Vendor & model name	CMO/AUO/LG
Screen Diagonal (mm)	15.4 inches
Display resolution (pixels)	1280 x 800 WXGA
Pixel Pitch	0.204 x 0.204
Pixel Arrangement	R.G.B. Vertical Stripe
Display Mode	Normally White
Typical White Luminance (NIT) also called Brightness	220
Luminance Uniformity	1.25 max.
Contrast Ratio	400 typical
Response Time msec	8
Nominal Input Voltage VDD	+3.3V
Viewing Angle (degree) Horizontal: Right/Left Vertical: Upper/Lower	45/45 15/35
Temperature Range(° C) Operating Storage (shipping)	0 to +50 -40 to +60

AC Adaptor

Item	Specification
Input	100-240V~ 1.5A, 50-60Hz/
Output	19V 4.74A 90W/19V 3.42A 65W

System Power Management

ACPI mode	Power Management
Mech. Off (G3)	All devices in the system are turned off completely.
Soft Off (G2/S5)	OS initiated shutdown. All devices in the system are turned off completely.
Working (G0/S0)	Individual devices such as the CPU and hard disc may be power managed in this state.
Suspend to RAM (S3)	CPU set power down VGA Suspend PCMCIA Suspend Audio Power Down Hard Disk Power Down CD-ROM Power Down Super I/O Low Power mode
Save to Disk (S4)	Also called Hibernation Mode. System saves all system states and data onto the disc prior to power off the whole system.

System Utilities

BIOS Setup Utility

The BIOS Setup Utility is a hardware configuration program built into your computer's BIOS (Basic Input/Output System).

Your computer is already properly configured and optimized, and you do not need to run this utility. However, if you encounter configuration problems, you may need to run Setup. Please also refer to Chapter 4 Troubleshooting when problem arises.

To activate the BIOS Utility, press **F2** during POST (when "Press <F2> to enter Setup" message is prompted on the bottom of screen).

Press **F2** to enter setup. The default parameter of F12 Boot Menu is set to "disabled". If you want to change boot device without entering BIOS Setup Utility, please set the parameter to "enabled".

Press <F12> during POST to enter multi-boot menu. In this menu, user can change boot device without entering BIOS SETUP Utility.

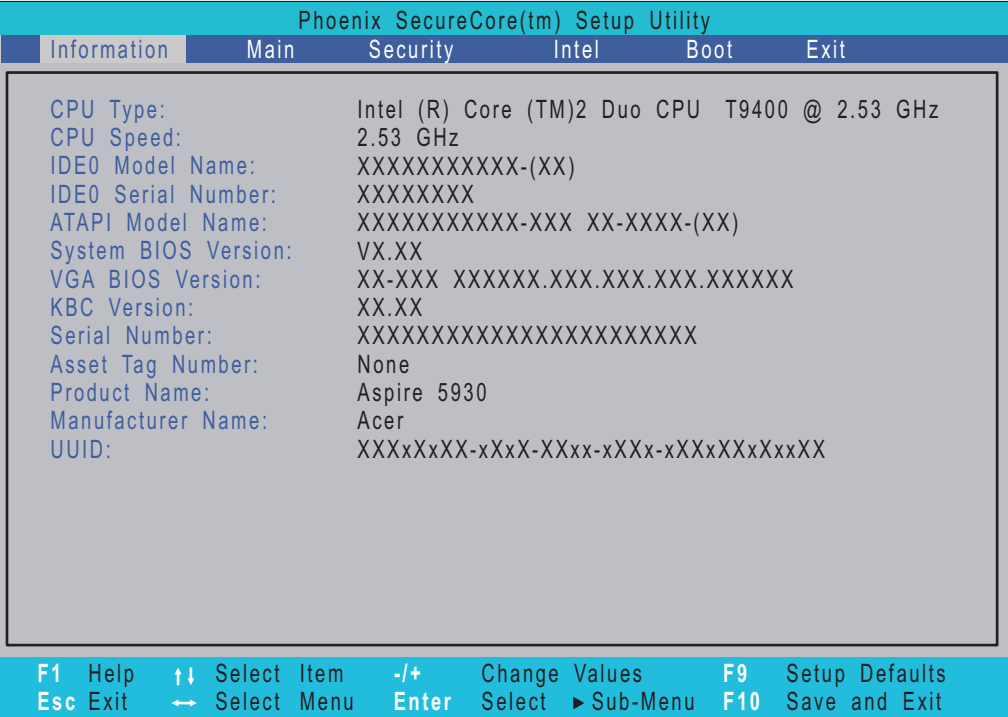

Navigating the BIOS Utility

There are six menu options: Information, Main, Advanced, Security, Boot, and Exit.

Follow these instructions:

- To choose a menu, use the left and right arrow keys.
- To choose an item, use the up and down arrow keys.
- To change the value of a parameter, press **F5** or **F6**.
- A plus sign (+) indicates the item has sub-items. Press **Enter** to expand this item.
- Press **Esc** while you are in any of the menu options to go to the Exit menu.
- In any menu, you can load default settings by pressing **F9**. You can also press **F10** to save any changes made and exit the BIOS Setup Utility.

NOTE: You can change the value of a parameter if it is enclosed in square brackets. Navigation keys for a particular menu are shown on the bottom of the screen. Help for parameters are found in the Item Specific Help part of the screen. Read this carefully when making changes to parameter values. **Please note that system information is subject to different models.**

Information

The Information screen displays a summary of your computer hardware information.

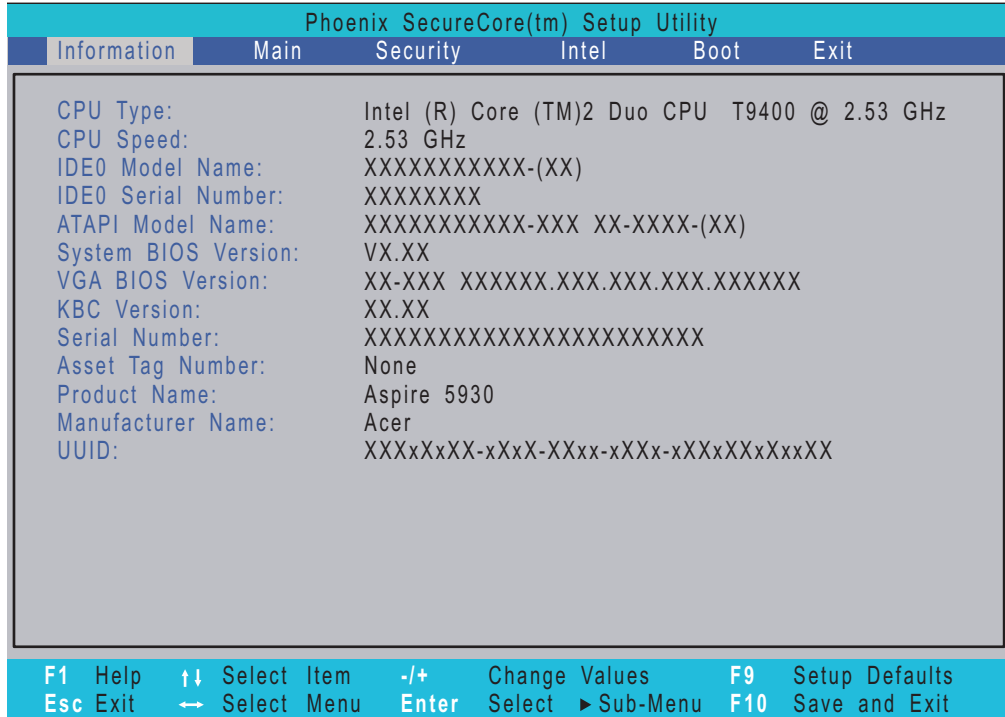

NOTE: The system information is subject to different models.

Parameter	Description
CPU Type	This field shows the CPU type and speed of the system.
CPU Speed	This field shows the speed of the CPU.
IDE0 Model Name	This field shows the model name of HDD installed on primary IDE master.
IDE0 Serial Number	This field displays the serial number of HDD installed on primary IDE master.
ATAPI Model Name	This field shows the model name of the Optical device installed in the system.
System BIOS Version	Displays system BIOS version.
VGA BIOS Version	This field displays the VGA firmware version of the system.
KBC Ver	This field shows the keyboard
Serial Number	This field displays the serial number of this unit.
Asset Tag Number	This field displays the asset tag number of the system.
Product Name	This field shows product name of the system.
Manufacturer Name	This field displays the manufacturer of this system.
UUID Number	Universally Unique Identifier (UUID) is an identifier standard used in software construction, standardized by the Open Software Foundation (OSF) as part of the Distributed Computing Environment (DCE).

Main

The Main screen allows the user to set the system time and date as well as enable and disable boot option and recovery.

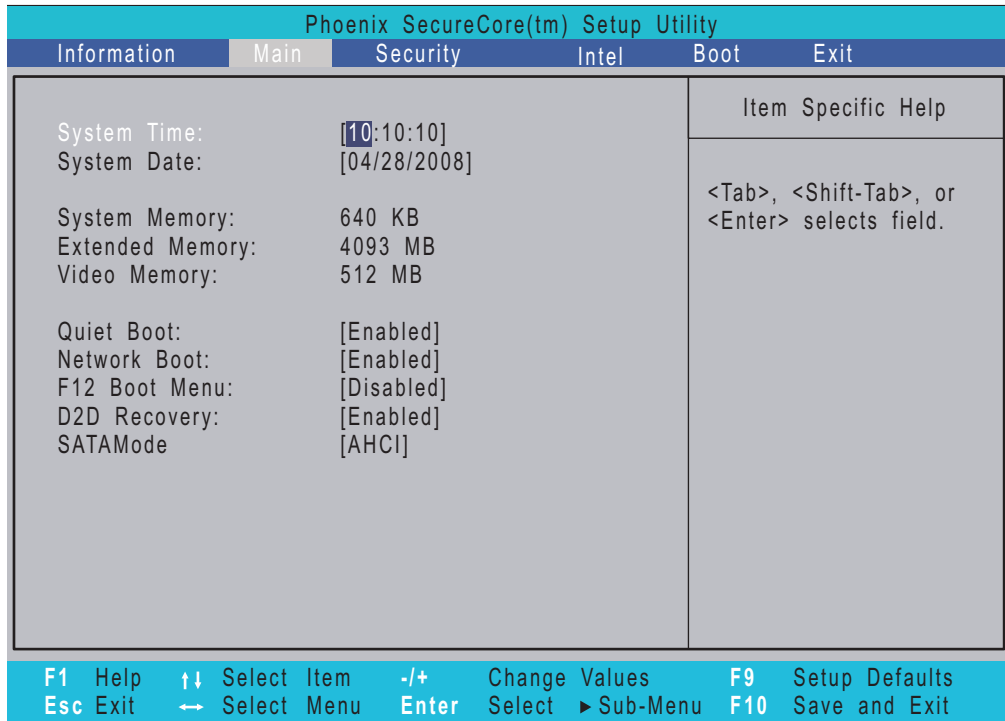

NOTE: The screen above is for your reference only. Actual values may differ.

The table below describes the parameters in this screen. Settings in **boldface** are the default and suggested parameter settings.

Parameter	Description	Format/Option
System Time	Sets the system time. The hours are displayed with 24-hour format.	Format: HH:MM:SS (hour:minute:second) System Time
System Date	Sets the system date.	Format MM/DD/YYYY (month/day/year) System Date
System Memory	This field reports the memory size of the system. Memory size is fixed to 640MB	
Extended Memory	This field reports the memory size of the extended memory in the system. Extended Memory size=Total memory size-1MB	
VGA Memory	Shows the VGA memory size.	
Quiet Boot	Determines if Customer Logo will be displayed or not; shows Summary Screen is disabled or enabled. Enabled: Customer Logo is displayed, and Summary Screen is disabled. Disabled: Customer Logo is not displayed, and Summary Screen is enabled.	Option: Enabled or Disabled
Network Boot	Enables, disables the system boot from LAN (remote server).	Option: Enabled or Disabled
F12 Boot Menu	Enables, disables Boot Menu during POST.	Option: Disabled or Enabled
D2D Recovery	Enables, disables D2D Recovery function. The function allows the user to create a hidden partition on hard disc drive to store operation system and restore the system to factory defaults.	Option: Enabled or Disabled
SATA Mode	Control the mode in which the SATA controller should operate.	Option: AHCI or IDE

NOTE: The sub-items under each device will not be shown if the device control is set to disable or auto. This is because the user is not allowed to control the settings in these cases.

Security

The Security screen contains parameters that help safeguard and protect your computer from unauthorized use.

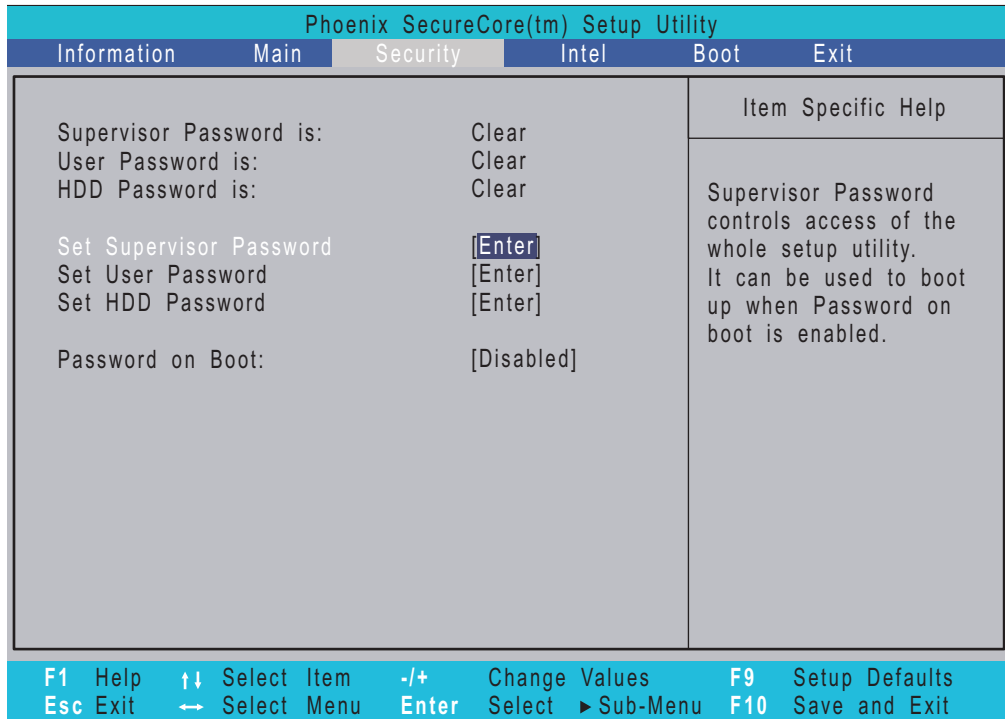

NOTE: Please refer to "Remove HDD/BIOS Password" section if you need to know how to remove HDD/BIOS Password.

The table below describes the parameters in this screen. Settings in **boldface** are the default and suggested parameter settings.

Parameter	Description	Option
Supervisor Password Is	Shows the setting of the Supervisor password	Clear or Set
User Password Is	Shows the setting of the user password.	Clear or Set
HDD Password Is	Shows the setting of the hard disk password.	Clear or Set
Set Supervisor Password	Press Enter to set the supervisor password. When set, this password protects the BIOS Setup Utility from unauthorized access. The user can not either enter the Setup menu nor change the value of parameters.	
Set User Password	Press Enter to set the user password. When user password is set, this password protects the BIOS Setup Utility from unauthorized access. The user can enter Setup menu only and does not have right to change the value of parameters.	
Set HDD Password	Enter HDD Password.	
Password on Boot	Defines whether a password is required or not while the events defined in this group happened. The following sub-options are all requires the Supervisor password for changes and should be grayed out if the user password was used to enter setup.	Disabled or Enabled

NOTE: When you are prompted to enter a password, you have three tries before the system halts. Don't forget your password. If you forget your password, you may have to return your notebook computer to your dealer to reset it.

Setting a Password

Follow these steps as you set the user or the supervisor password:

1. Use the "w" and "y" keys to highlight the Set Supervisor Password parameter and press the e key. The Set Supervisor Password box appears:

Set Supervisor Password		
Enter New Password	[]
Confirm New Password	[]

2. Type a password in the "Enter New Password" field. The password length can not exceeds 8 alphanumeric characters (A-Z, a-z, 0-9, not case sensitive). Retype the password in the "Confirm New Password" field.

IMPORTANT: Be very careful when typing your password because the characters do not appear on the screen.

3. Press e.
After setting the password, the computer sets the User Password parameter to "Set".
4. If desired, you can opt to enable the Password on boot parameter.
5. When you are done, press u to save the changes and exit the BIOS Setup Utility.

Removing a Password

Follow these steps:

1. Use the **w** and **y** keys to highlight the Set Supervisor Password parameter and press the **e** key. The Set Password box appears:

Set Supervisor Password		
Enter current password	[]
Enter New Password	[]
Confirm New Password	[]

2. Type the current password in the Enter Current Password field and press **e**.
3. Press **e** twice **without** typing anything in the Enter New Password and Confirm New Password fields. The computer then sets the Supervisor Password parameter to "Clear".
4. When you have changed the settings, press **u** to save the changes and exit the BIOS Setup Utility.

Changing a Password

1. Use the **w** and **y** keys to highlight the Set Supervisor Password parameter and press the **e** key. The Set Password box appears:

Set Supervisor Password		
Enter current password	[]
Enter New Password	[]
Confirm New Password	[]

2. Type the current password in the Enter Current Password field and press **e**.
3. Type a password in the Enter New Password field. Retype the password in the Confirm New Password field.
4. Press **e**. After setting the password, the computer sets the User Password parameter to "Set".
5. If desired, you can enable the Password on boot parameter.
6. When you are done, press **u** to save the changes and exit the BIOS Setup Utility.

If the verification is OK, the screen will display as following.

Setup Notice
Changes have been saved.
[continue]

The password setting is complete after the user presses **u**.

If the current password entered does not match the actual current password, the screen will show you the Setup Warning.

Setup Warning
Invalid password
Re-enter Password
[continue]

If the new password and confirm new password strings do not match, the screen will display the following message.

Setup Warning
Password do not match
Re-enter Password

Intel

The Intel screen allows the user to set the Legacy OS Boot, CPU, MCH, ICH and ACPI Control Sub-Menu and the Video Repost.

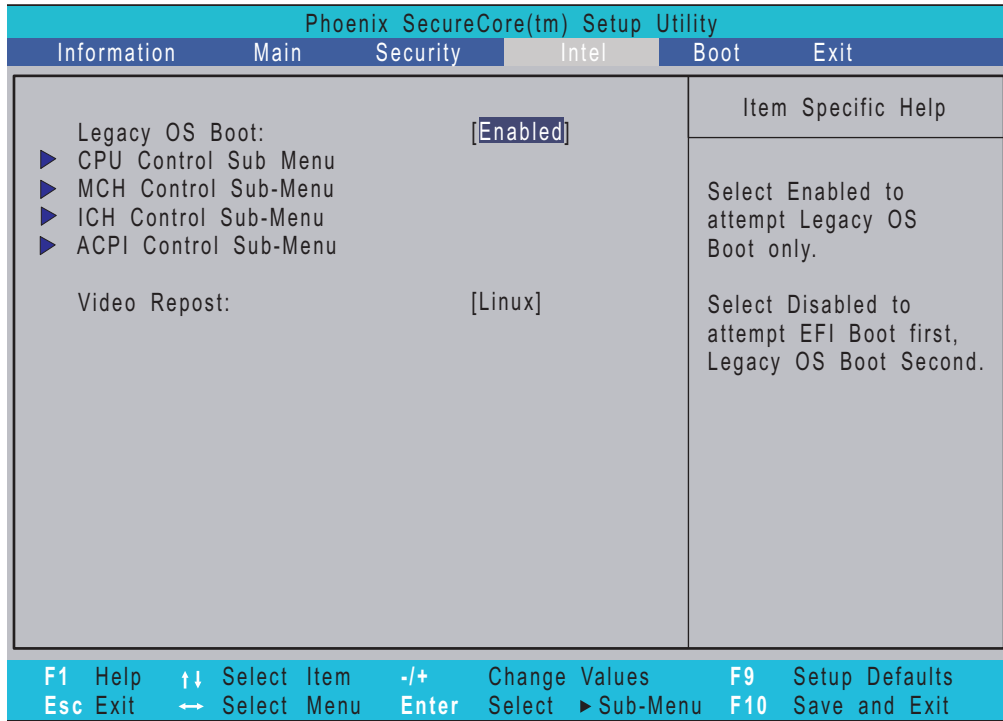

The table below describes the parameters in this screen. Settings in **boldface** are the default and suggested parameter settings.

Parameter	Description	Format/Option
Legacy OS Boot	Let you choose which to boot first, EFI or Legacy OS.	Option: Enabled or Disabled
CPU Control Sub-Menu	These items control various CPU parameters	
MCH Control Sub-Menu	These items control various MCH parameters	
ICH Control Sub-Menu	These items control various ICH parameters	
ACPI Control Sub-Menu	These items control various ACPI parameters	
Video Repost	Select if a Video Repost is to be performed during resume from S3	Option: Linux , Enabled or Disabled

Boot

This menu allows the user to decide the order of boot devices to load the operating system. Bootable devices includes the diskette drive in module bay, the onboard hard disk drive and the CD-ROM in module bay.

Phoenix SecureCore(tm) Setup Utility					
Information	Main	Security	Intel	Boot	Exit
Boot priority order: 1: IDE HDD: XXXXXXXXXXXX-(XX) 2: IDE CD: XXXXXXXXXXXX-XXX XX-XXXX-XX 3: PCI LAN: Network Boot 4: USB HDD: 5: USB FDD: 6: USB Key: 7: USB CDROM:				Item Specific Help Use <↑> or <↓> to select a device, then press <F6> to move it up the list, or <F5> to move it down the list. Press <Esc> to escape the menu.	
F1 Help	↑↓ Select Item	-/+ Change Values	F9 Setup Defaults		
Esc Exit	↔ Select Menu	Enter Select	▶ Sub-Menu	F10 Save and Exit	

Exit

The Exit screen contains parameters that confirmed or discard the changes made to the parameters in the BIOS Setup Utility.

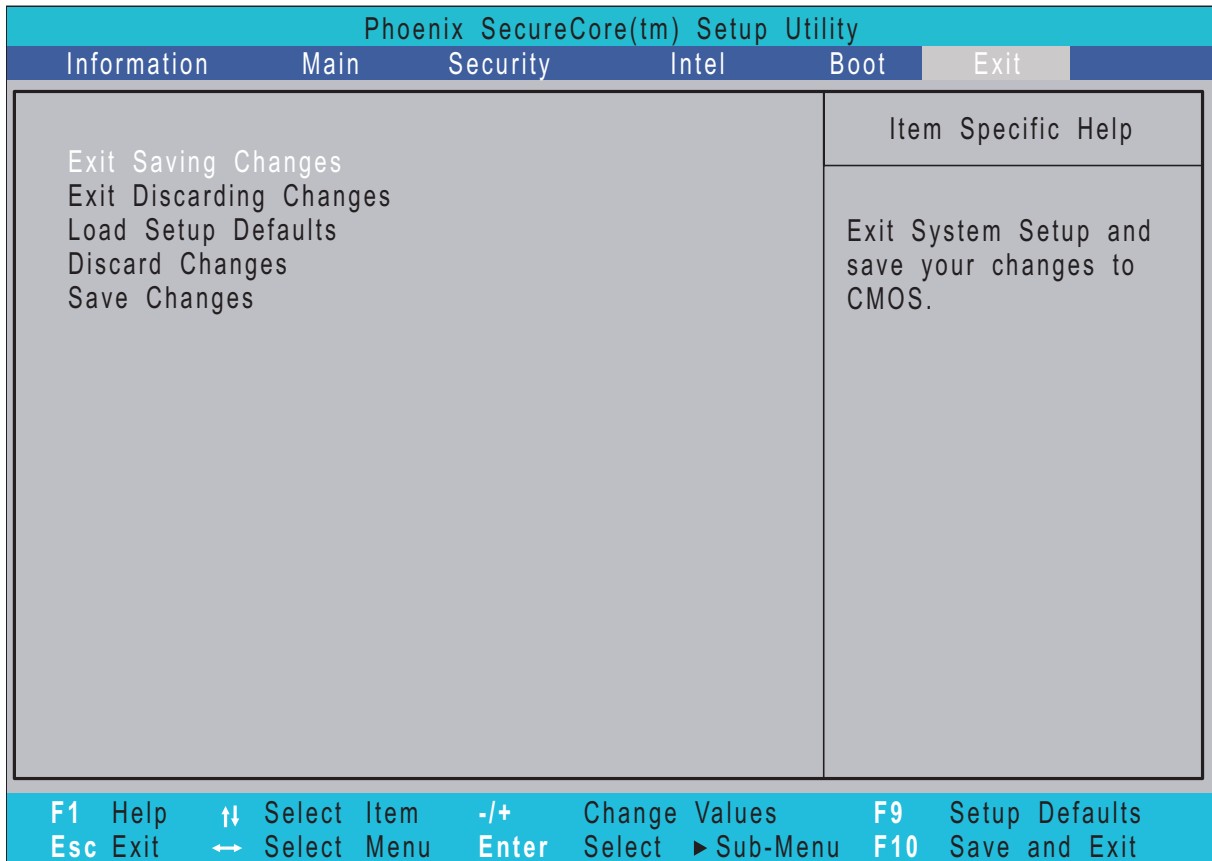

The table below describes the parameters in this screen.

Parameter	Description
Exit Saving Changes	Exit System Setup and save your changes to CMOS.
Exit Discarding Changes	Exit utility without saving setup data to CMOS.
Load Setup Default	Load default values for all SETUP item.
Discard Changes	Load previous values from CMOS for all SETUP items.
Save Changes	Save Setup Data to CMOS.

BIOS Flash Utility

The BIOS flash memory update is required for the following conditions:

- New versions of system programs
- New features or options
- Restore a BIOS when it becomes corrupted.

Use the Flash utility to update the system BIOS flash ROM.

NOTE: If you do not have a crisis recovery diskette at hand, then you should create a **Crisis Recovery Diskette** before you use the Flash utility.

NOTE: Do not install memory-related drivers (XMS, EMS, DPMS) when you use the Flash.

NOTE: Please use the AC adaptor power supply when you run the Flash utility. If the battery pack does not contain enough power to finish BIOS flash, you may not boot the system because the BIOS is not completely loaded.

Follow the steps below to run the Flash.

1. Prepare a bootable diskette.
2. Copy the flash utilities to the bootable diskette.
3. Then boot the system from the bootable diskette. The flash utility has auto-execution function.

Remove HDD/BIOS Utility

This section provide you with removing HDD/BIOS method:

Remove HDD Password:

- ❑ If you key in wrong HDD password for three time, "HDD password error code" would display on the screen. See the image below.

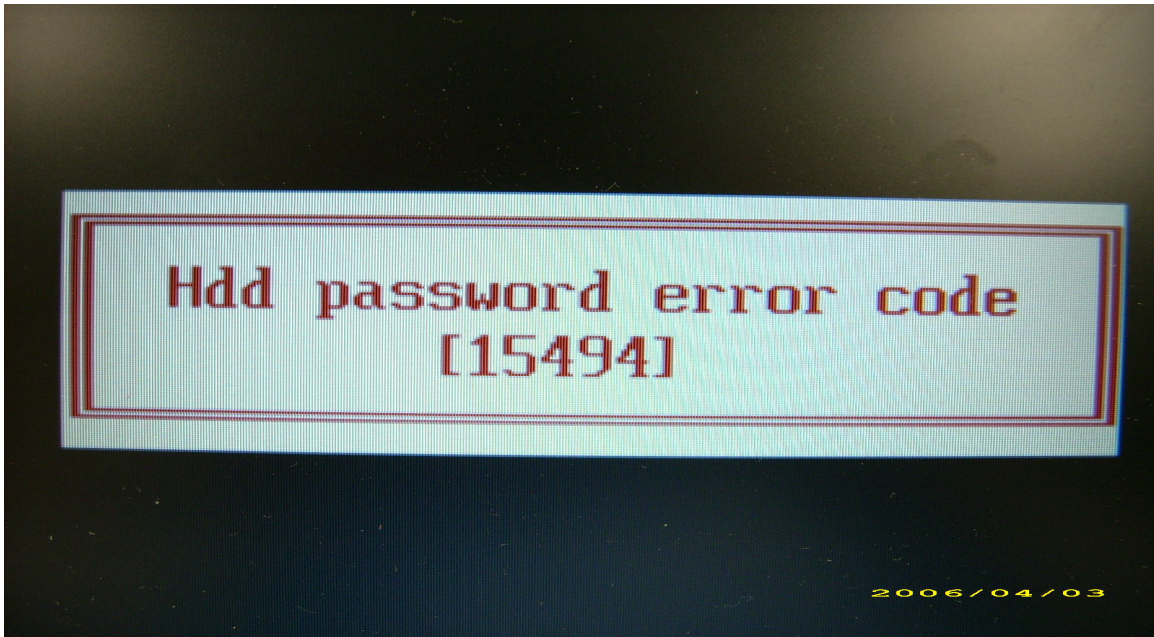

- ❑ If you need to solve HDD password locked problem, you can run HDD_PW.EXE
 1. Key in "hdd_pw 15494 0"
 2. Select "2"
 3. Choose one upper-case string

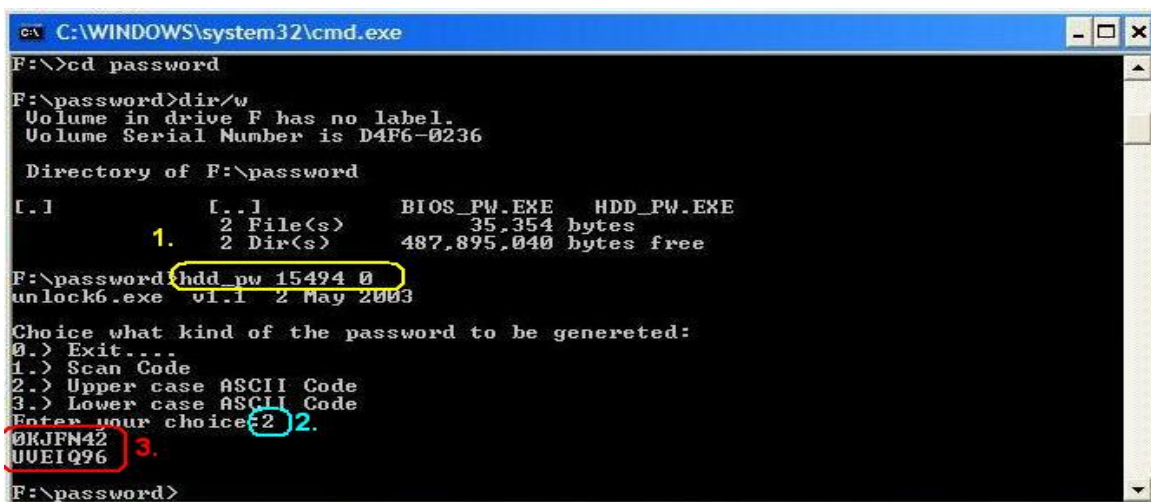

- ❑ Reboot system and key in "0KJFN42" or "UVEIQ96" to HDD user password.

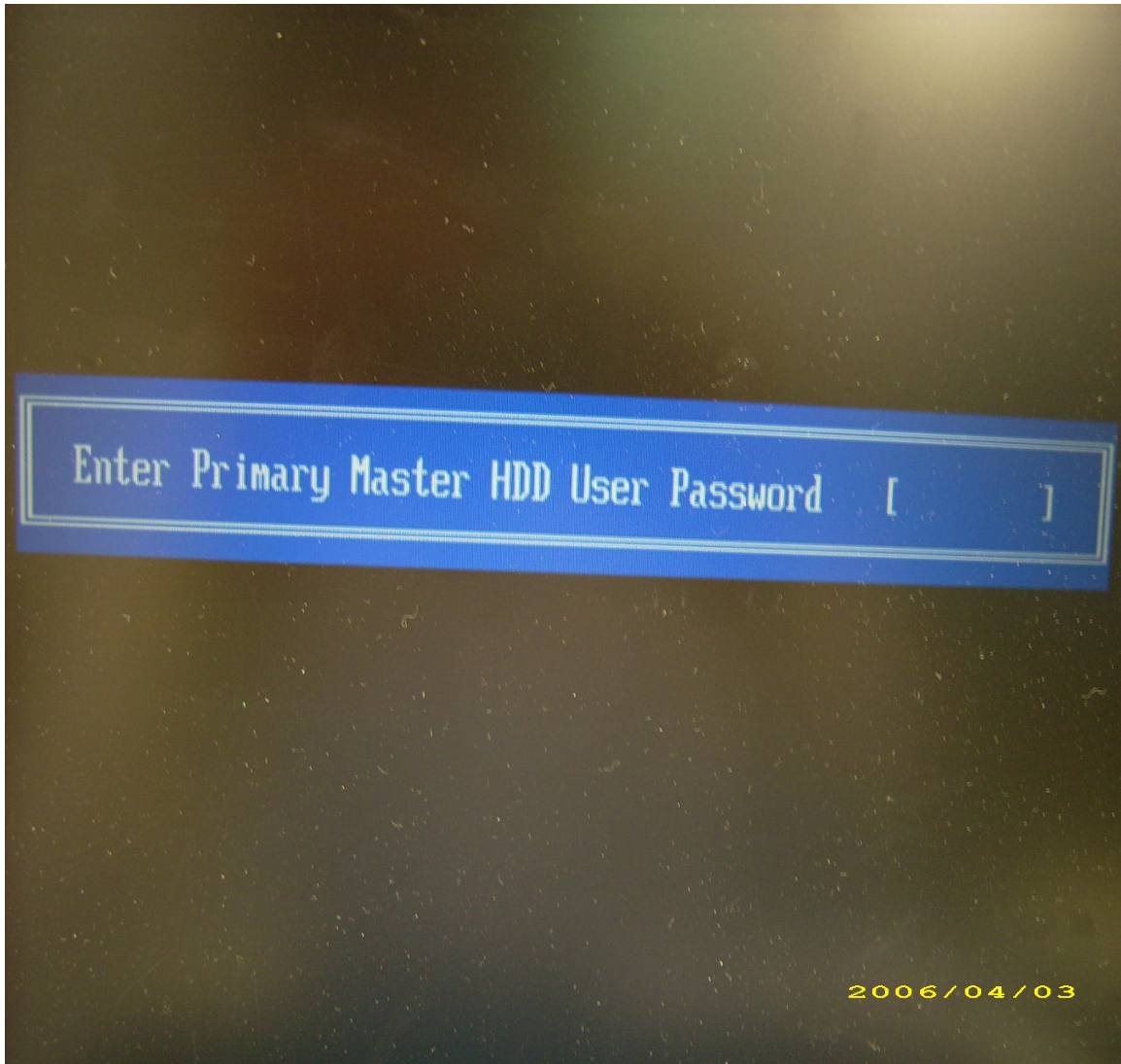

Remove BIOS Password:

- If you key in wrong Supervisor Password for three time, "System Disabled" would display on the screen. See the image below.

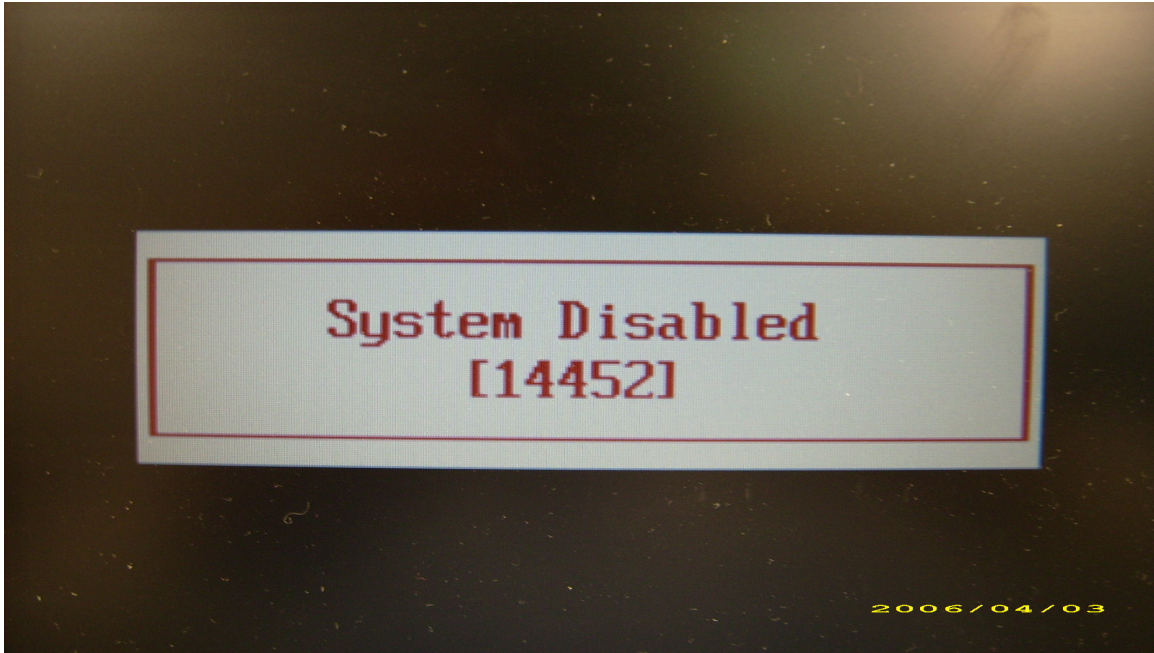

- If you need to solve BIOS password locked problem, you can run BIOS_PW.EXE
 1. Key in "bios_pw 14452 0"
 2. Choose one upper-case string

```
C:\WINDOWS\system32\cmd.exe
Microsoft Windows XP [Version 5.1.2600]
(C) Copyright 1985-2001 Microsoft Corp.
C:\Documents and Settings\M54>d:
D:\>bios_pw 14452 0
unlock6.exe v1.0 1 July 1997
qjjg9vy
07yqmjd
cjl14tm
6mbzjaj
D:\>_
```

- Reboot the system and key in "qjjg9vy" or "07yqmjd" to BIOS user password.



Machine Disassembly and Replacement

This chapter contains step-by-step procedures on how to disassemble the notebook computer for maintenance and troubleshooting.

Disassembly Requirements

To disassemble the computer, you need the following tools:

- Wrist grounding strap and conductive mat for preventing electrostatic discharge
- Flat screwdriver
- Philips screwdriver
- Hex screwdriver
- Plastic flat screwdriver
- Plastic tweezers

NOTE: The screws for the different components vary in size. During the disassembly process, group the screws with the corresponding components to avoid mismatch when putting back the components.

General Information

Pre-disassembly Instructions

Before proceeding with the disassembly procedure, make sure that you do the following:

1. Turn off the power to the system and all peripherals.
2. Unplug the AC adapter and all power and signal cables from the system.



3. Place the system on a flat, stable surface.
4. Remove the battery pack.

Disassembly Process

The disassembly process is divided into the following stages:

- External module disassembly
- Main unit disassembly
- LCD module disassembly

The flowcharts provided in the succeeding disassembly sections illustrate the entire disassembly sequence. Observe the order of the sequence to avoid damage to any of the hardware components. For example, if you want to remove the main board, you must first remove the keyboard, then disassemble the inside assembly frame in that order.

Main Screw List

Item	Screw	Color	Part No.
A	M2 x L4	Black	86.00E13.524
B	M2.5 x L6	Black	86.00E12.536
C	M2 x L3	Black	86.9A522.3R0
D	M3 x L4	Silver	86.9A524.4R0
E	M2.5 x L10	Black	86.00F84.73A

External Module Disassembly Process

External Modules Disassembly Flowchart

The flowchart below gives you a graphic representation on the entire disassembly sequence and instructs you on the components that need to be removed during servicing. For example, if you want to remove the main board, you must first remove the keyboard, then disassemble the inside assembly frame in that order.

EXTERNAL MODULE DISASSEMBLY

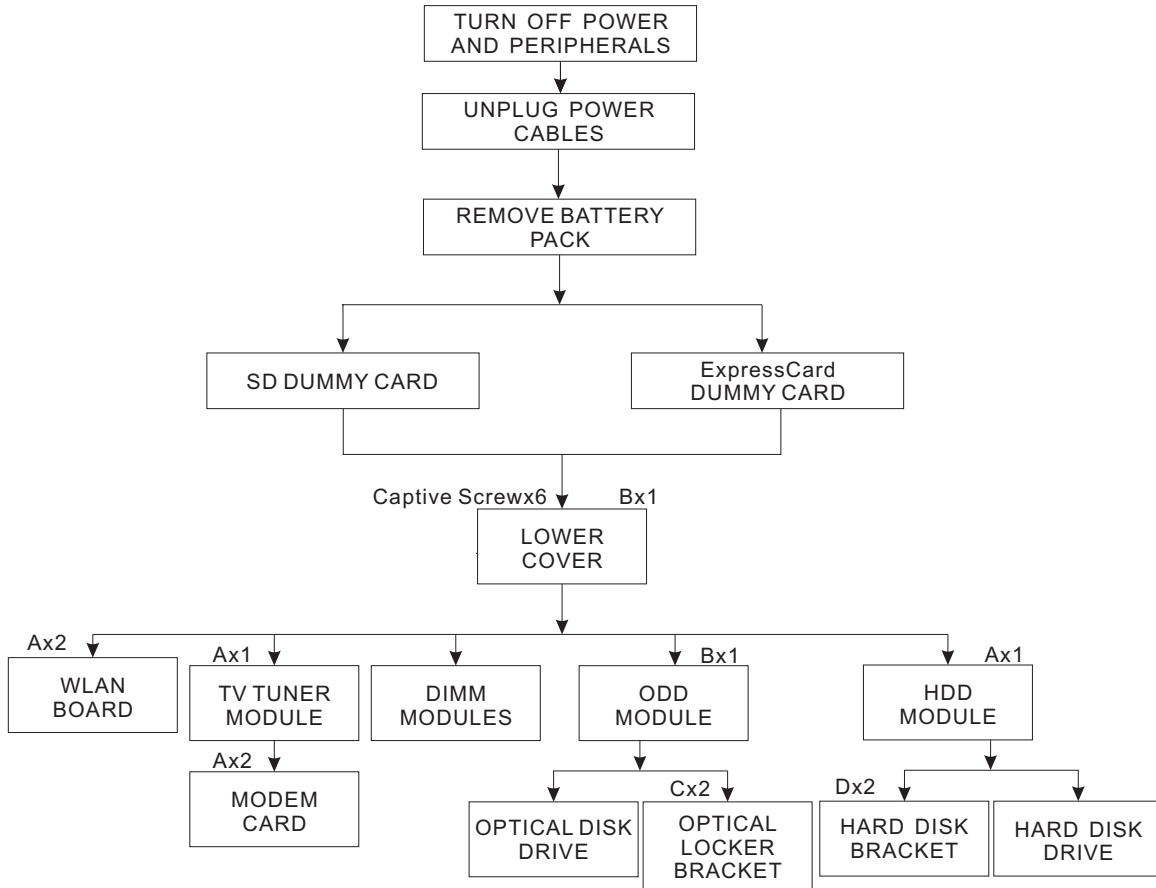

Screw List

Item	Screw	Color	Part No.
A	M2 x L4	Black	86.00E13.524
B	M2.5 x L6	Black	86.00E12.536
C	M2 x L3	Black	86.9A522.3R0
D	M3 x L4	Silver	86.9A524.4R0

Removing the Battery Pack

1. Turn base unit over.
2. Slide the battery lock/unlock latch to the unlock position.



3. Slide the battery release latch to the release position to pop out the battery pack, then remove the battery pack from the main unit.

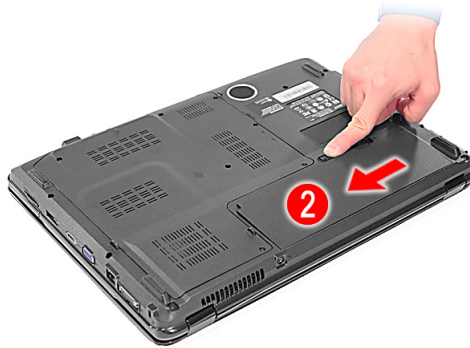

Removing the SD dummy card

1. Push the SD dummy card all the way in to eject it.



2. Pull it out from the slot.



Removing the ExpressCard dummy card

1. Push the ExpressCard dummy card all the way in to eject it.



2. Pull it out from the slot.



Removing the Lower Cover

1. See “Removing the Battery Pack” on page 60.
2. Remove the six captive screws and the one screw (B) on the lower cover.

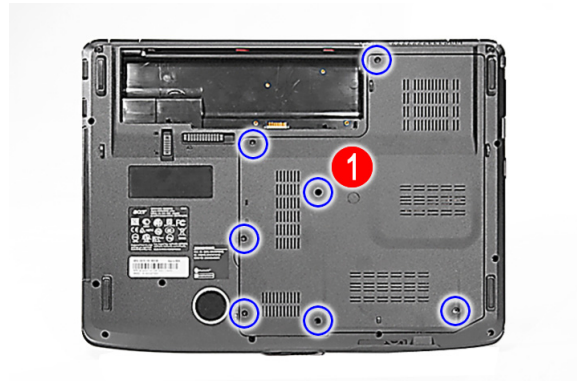

Step	Size (Quantity)	Color	Torque
1	M2.5 x L6 (1)	Black	1.6 kgf-cm

3. Use a plastic screw driver to carefully pry open the lower cover.



-
4. Remove the lower cover from the lower case.

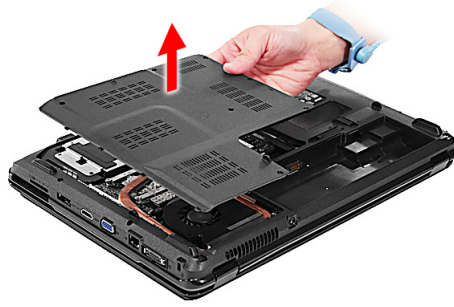

Removing the DIMM

1. See “Removing the Battery Pack” on page 60.
2. See “Removing the Lower Cover” on page 62..
3. Push out the latches on both sides of the DIMM socket to release the DIMM.

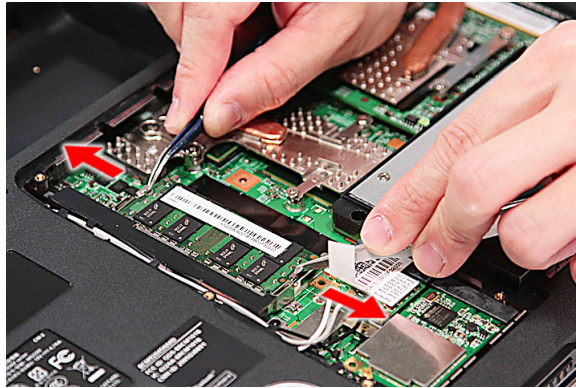

4. Remove the DIMM module.

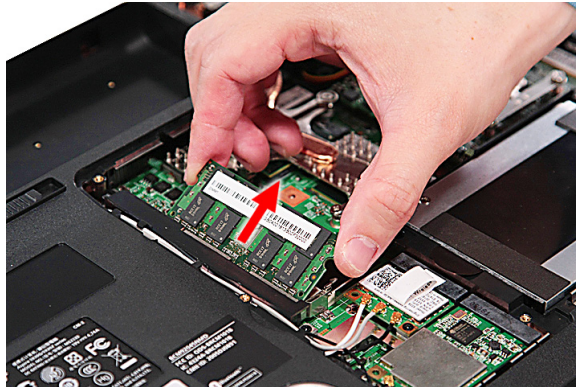

Removing the WLAN Board Modules

1. See “Removing the Battery Pack” on page 60.
2. See “Removing the Lower Cover” on page 62.

3. Disconnect the antenna cables from the WLAN board.

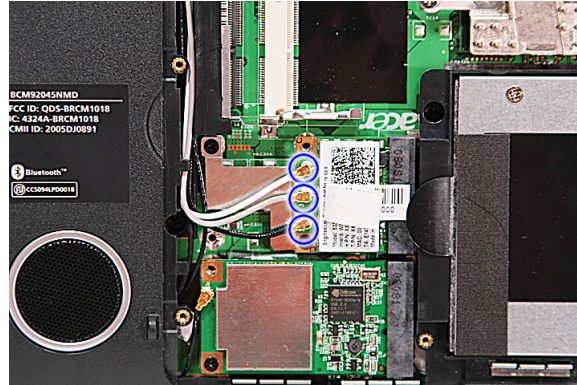

NOTE: There are 3 antenna cables connected to the WLAN board module. The Black antenna cable is connected to number 1 connector, the White antenna cable is connected to number 2 connector and the Gray antenna cable is connected to number 3 connector.

4. Move the antenna away from the WLAN board and remove the one screw (A) on the WLAN board to release the WLAN board.

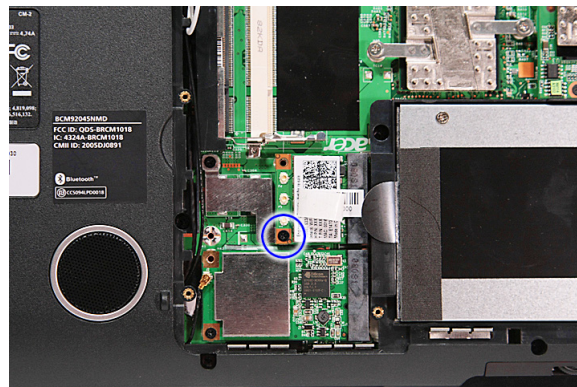

Step	Size (Quantity)	Color	Torque
1	M2 x L4 (1)	Black	1.6 kgf-cm

5. Detach the WLAN board from the WLAN socket.

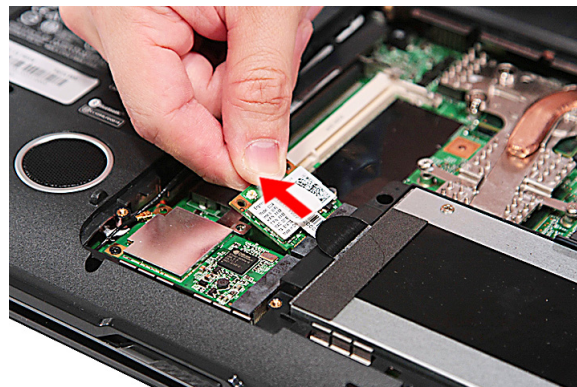

NOTE: When attaching the antenna back to the WLAN board, make sure the cable are arranged properly.

Removing the TV Tuner Board Modules

1. See “Removing the Battery Pack” on page 60.
2. See “Removing the Lower Cover” on page 62.

3. Disconnect the antenna cable from the TV tuner board and remove the one screw (A) to release the board.

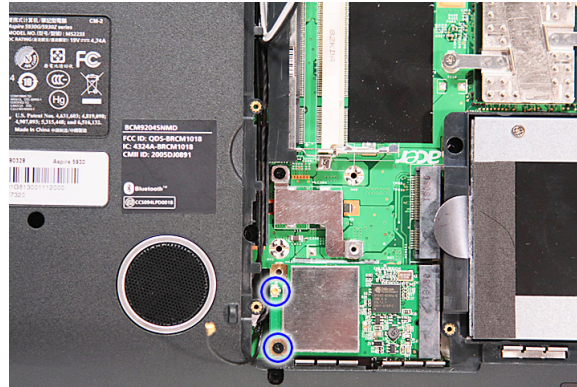

Step	Size (Quantity)	Color	Torque
1	M2 x L4 (1)	Black	1.6 kgf-cm

4. Detach the TV tuner board from the socket.



NOTE: When attaching the antenna back to the TV tuner board, make sure the cable are arranged properly.

Removing the Modem Board

1. See “Removing the Battery Pack” on page 60.
2. See “Removing the Lower Cover” on page 62.
3. See “Removing the TV Tuner Board Modules” on page 64..
4. Remove the two screws (A) securing the modem card.

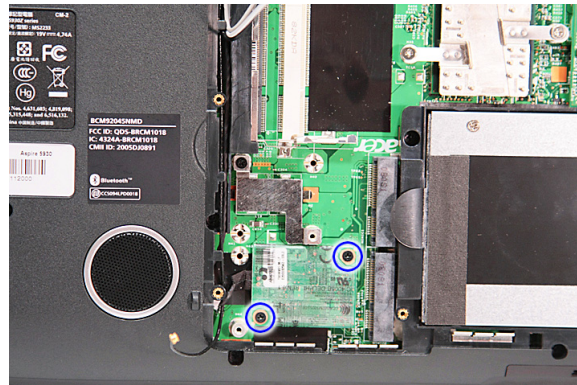

Step	Size (Quantity)	Color	Torque
1~2	M2 x L4 (2)	Black	1.6 kgf-cm

5. Lift the modem board from the system.

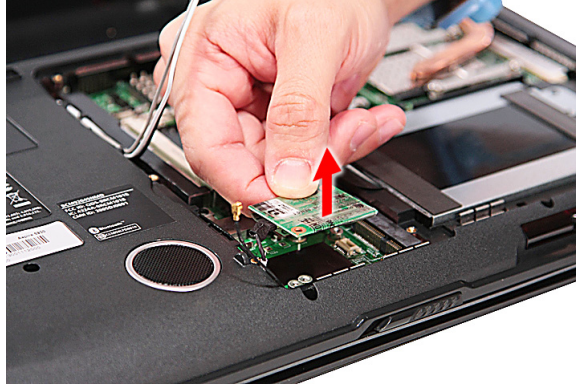

6. Disconnect the cable from the modem board.

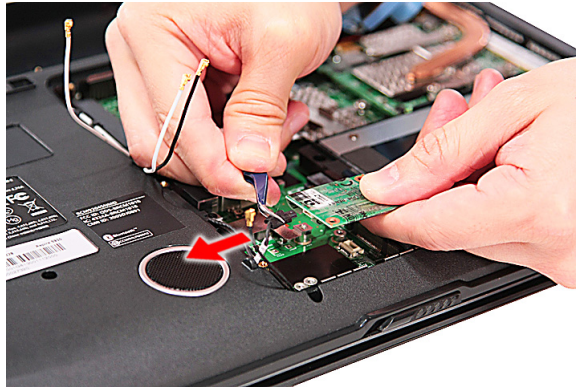

Removing the Hard Disk Drive Module

1. See "Removing the Battery Pack" on page 60.
2. See "Removing the Lower Cover" on page 62.
3. Remove the one screw (A) securing the hard disk drive module.



Step	Size (Quantity)	Color	Torque
1	M2 x L4 (1)	Black	3.0 kgf-cm

-
- Slide the hard disk drive module away from the connector.



- Use the plastic tab to lift the hard disk drive module and remove it from the hard disk drive bay.



NOTE: To prevent damage to device, avoid pressing down on it or placing heavy objects on top of it.

- Remove the two screws (D) securing the hard disk to the bracket and remove the hard disk from the bracket.





Step	Size (Quantity)	Color	Torque
1~2	M3 x L4 (2)	Silver	3.0 kgf-cm

Removing the Optical Drive Module

1. See “Removing the Battery Pack” on page 60.
2. See “Removing the Lower Cover” on page 62.
3. See “Removing the WLAN Board Modules” on page 63.
4. See “Removing the TV Tuner Board Modules” on page 64.
5. Release the antenna cables from the latches as shown.

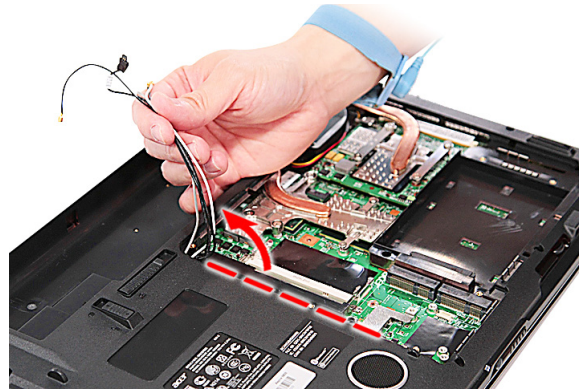

6. Remove the one screw (B) from the bottom panel.



Step	Size (Quantity)	Color	Torque
1	M2.5 x L6 (1)	Black	3.0 kgf-cm

-
7. Use a pin and push it inside the emergency eject hole to eject the odd drive tray.



8. Carefully pull out the odd drive tray until the part of the module is visible and then slowly push back to close the tray into the module still partially exposed.

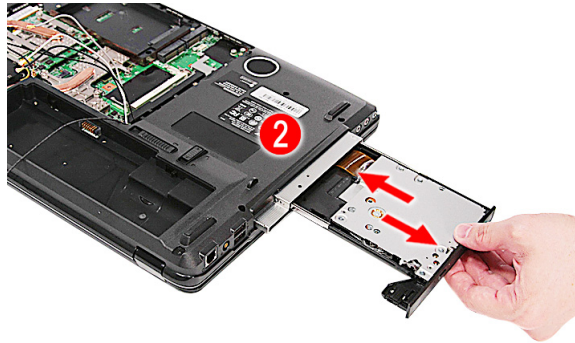

9. Slowly pull out the odd module from the odd drive bay.

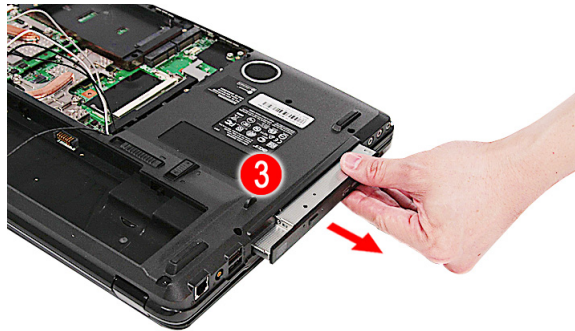

-
10. Remove the two screws (C) securing the locker bracket and remove the locker bracket from the optical disk drive module.

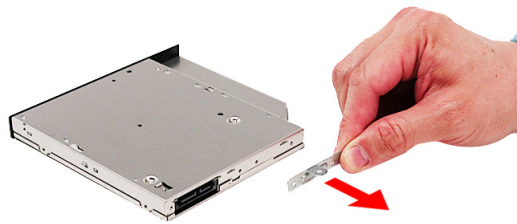

Step	Size (Quantity)	Color	Torque
1~2	M2 x L3 (2)	Silver	1.6 kgf-cm

Main Unit Disassembly Process

Main Unit Disassembly Flowchart

MAIN UNIT DISASSEMBLY

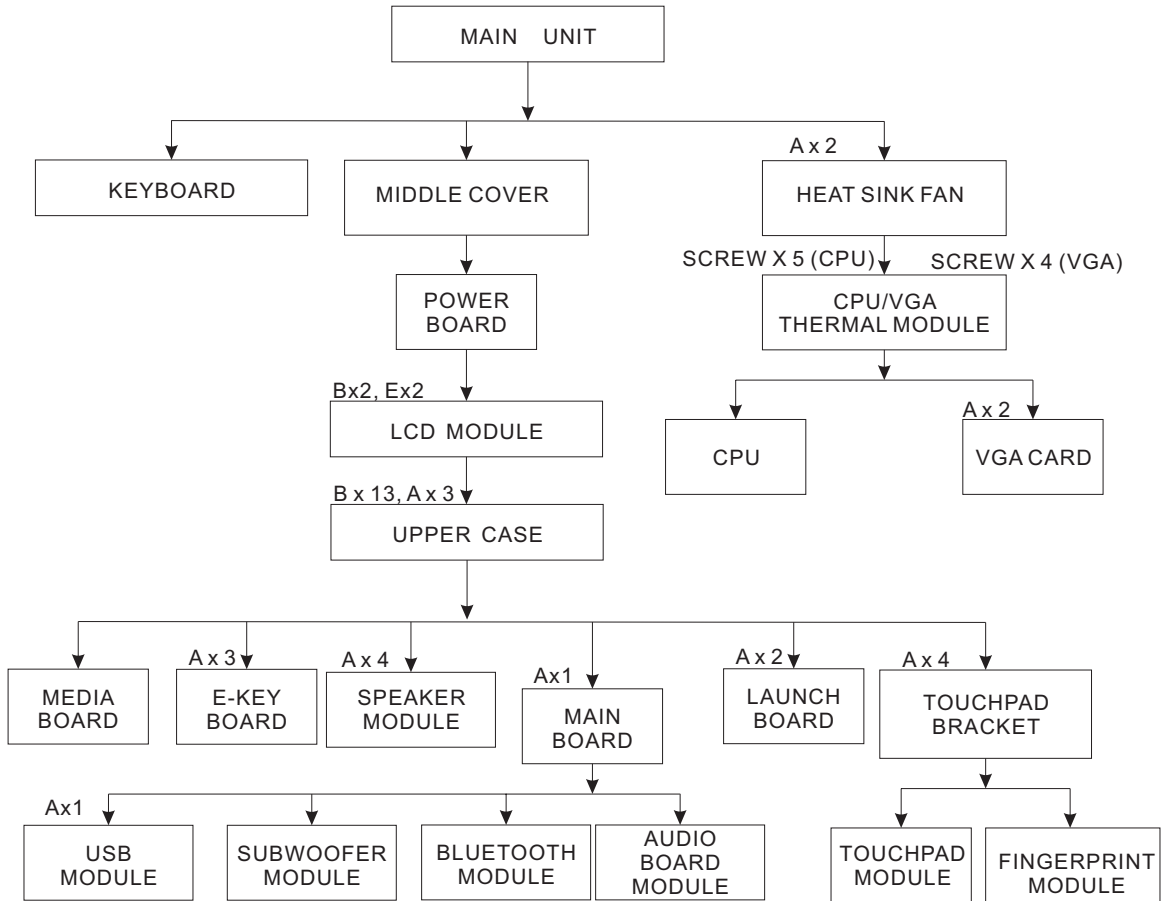

Screw List

Item	Screw	Color	Part No.
A	M2 x L4	Black	86.00E13.524
B	M2.5 x L6	Black	86.00E12.536
E	M2.5 x L10	Black	86.00F84.73A

Removing the Keyboard

1. See "Removing the Battery Pack" on page 60.
2. Push down on the lock and release the latches securing the keyboard to the upper case.



3. Carefully pry loose the keyboard and turn it over on the touchpad area.



-
4. Disconnect the keyboard cable from the main board to remove the keyboard.

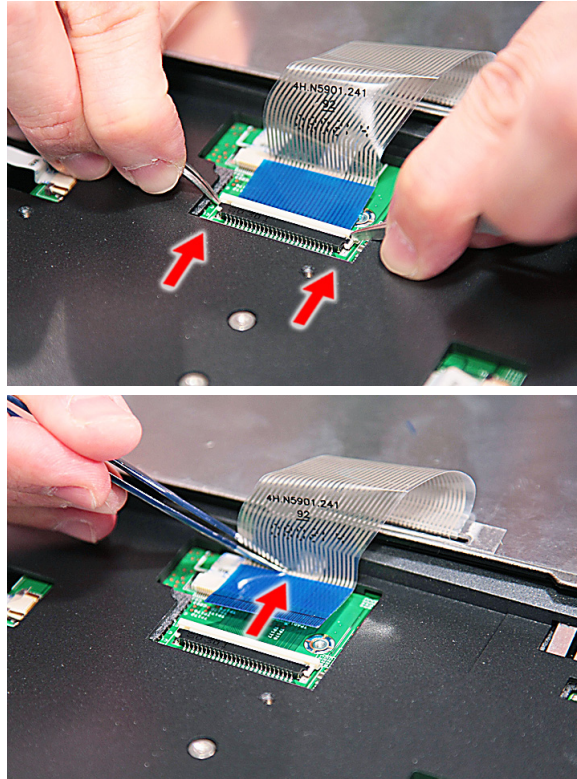

Removing the Middle Cover

1. See "Removing the Battery Pack" on page 60.
2. Use a plastic screw driver to pry loose the side of the middle cover.



-
3. Carefully pry loose the middle cover from the latches securing it and remove the middle cover.



Removing the Power Board

1. See “Removing the Battery Pack” on page 60.
2. See “Removing the Middle Cover” on page 73..
3. Disconnect the cable from the Power Board connector.

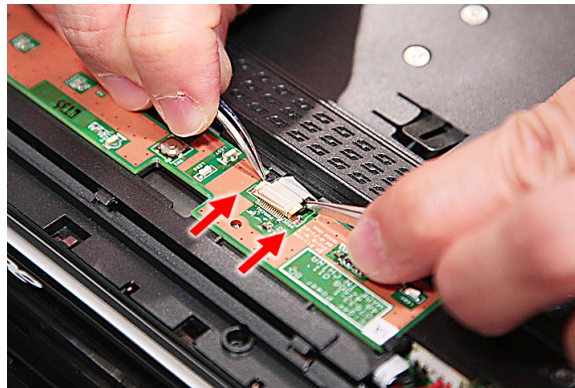

- Remove the one screw (A) securing the Power Board to the upper case.

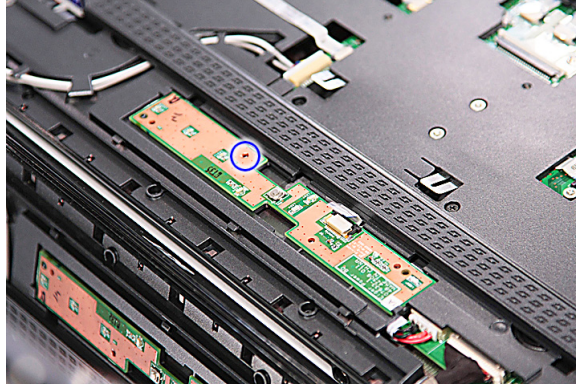

Step	Size (Quantity)	Color	Torque
1	M2 x L4 (1)	Black	1.6 kgf-cm

- Release the Power Board from the latches and remove the Power Board from the upper case.

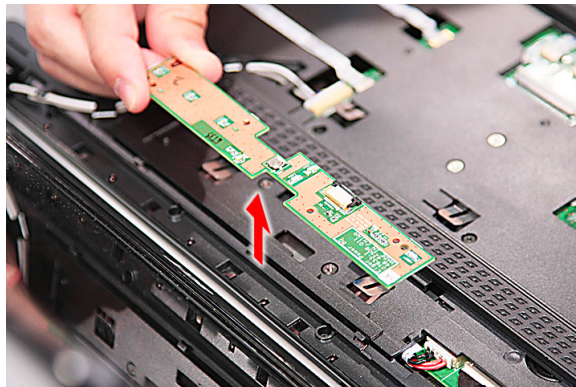

Removing the Heatsink Fan Module

- See "Removing the Battery Pack" on page 60.
- See "Removing the Lower Cover" on page 62.
- Remove the two screws (A) securing the heatsink fan module in place.

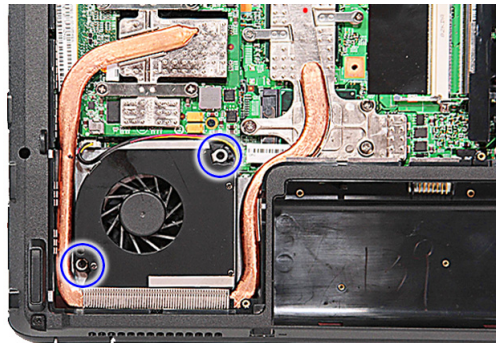

Step	Size (Quantity)	Color	Torque
1~2	M2 x L4 (2)	Black	1.6 kgf-cm

4. Lift the heatsink fan module and disconnect the heatsink fan connector from the main board.

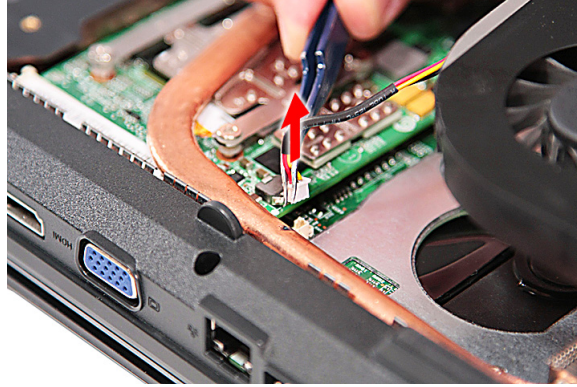

5. Carefully lift up the heatsink fan module.

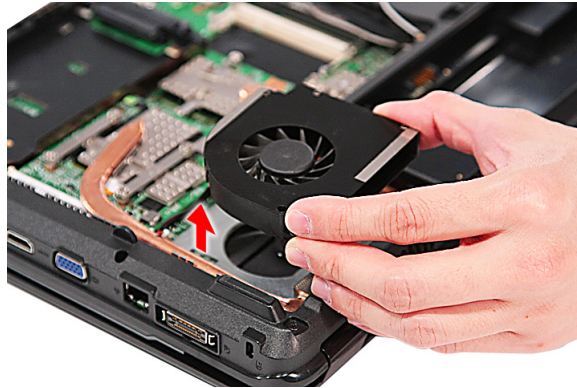

Removing the CPU and VGA Heatsink Module

1. See “Removing the Battery Pack” on page 60.
2. See “Removing the Lower Cover” on page 62.
3. See “Removing the Heatsink Fan Module” on page 75.
4. Remove the four screws securing the VGA board heatsink module (Discrete Model only) and the five screws securing the CPU heatsink module.

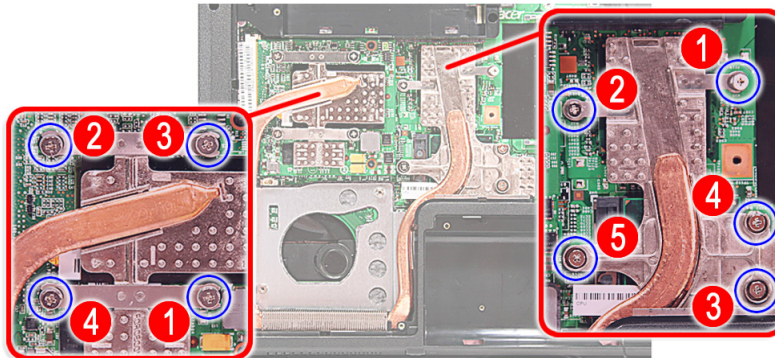

-
5. Carefully remove the heatsink module from the system.



Removing the CPU

1. See “Removing the Battery Pack” on page 60.
2. See “Removing the Lower Cover” on page 62.
3. See “Removing the Heatsink Fan Module” on page 75.
4. See “Removing the CPU and VGA Heatsink Module” on page 76.
5. Using a flat screwdriver, turn the CPU socket latch counter-clockwise to release the CPU.

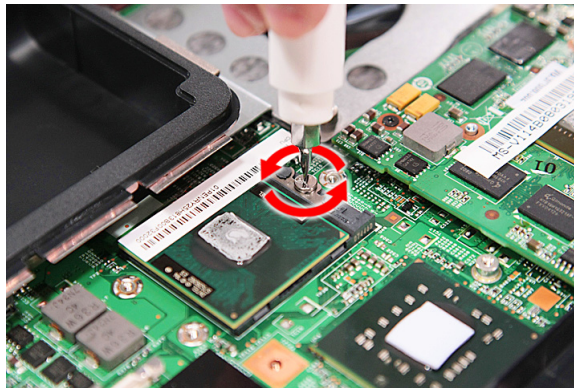

- Lift up carefully to remove the CPU.

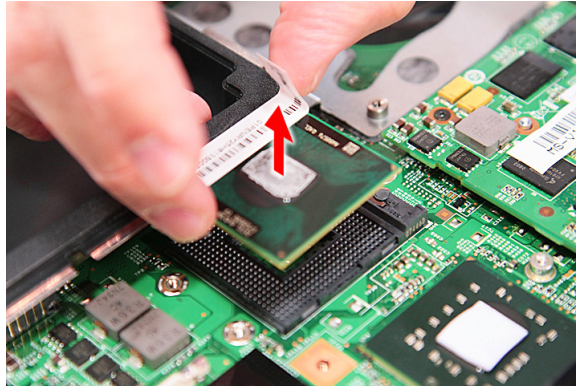

NOTE: When installing the CPU, make sure to install the CPU with PIN 1 at the corner as shown.

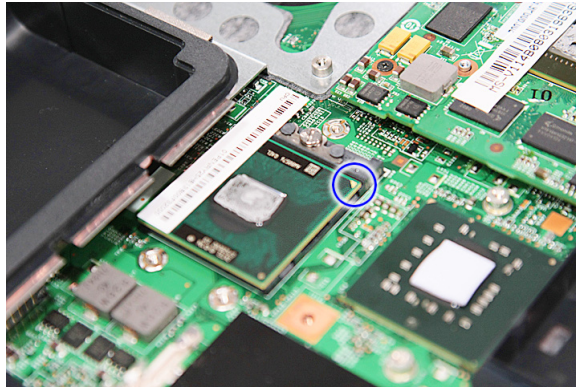

Removing the VGA Board (Discrete Model only)

- See “Removing the Battery Pack” on page 60.
- See “Removing the Lower Cover” on page 62.
- See “Removing the Heatsink Fan Module” on page 75.
- See “Removing the CPU and VGA Heatsink Module” on page 76.
- Remove the two screws (A) securing the VGA board to the main board.

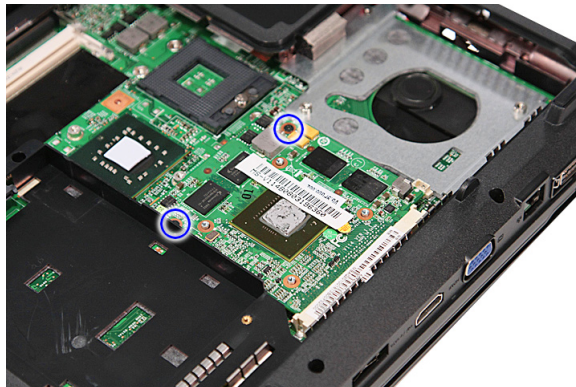

Step	Size (Quantity)	Color	Torque
1~2	M2 x L4 (2)	Black	1.6 kgf-cm

6. Remove the VGA board from the main board.



Removing the LCD Module

1. See "Removing the Battery Pack" on page 60.
2. See "Removing the SD dummy card" on page 61.
3. See "Removing the ExpressCard dummy card" on page 61.
4. See "Removing the Lower Cover" on page 62.
5. See "Removing the DIMM" on page 63.
6. See "Removing the WLAN Board Modules" on page 63.
7. See "Removing the TV Tuner Board Modules" on page 64.
8. See "Removing the Hard Disk Drive Module" on page 66.
9. See "Removing the Keyboard" on page 72.
10. See "Removing the Middle Cover" on page 73.
11. Turn over the system and remove the two screws (B) from the bottom of the left and right hinges.

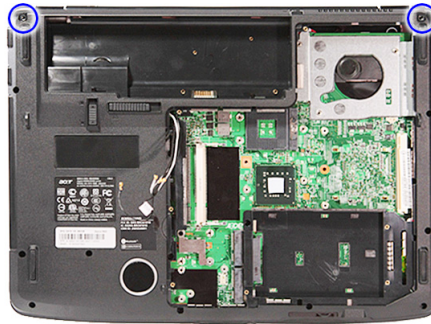

Step	Size (Quantity)	Color	Torque
1~2	M2.5 x L6 (2)	Black	3.0 kgf-cm

12. Carefully pull out the wireless antenna cables from the hole and release the cables from the latches.

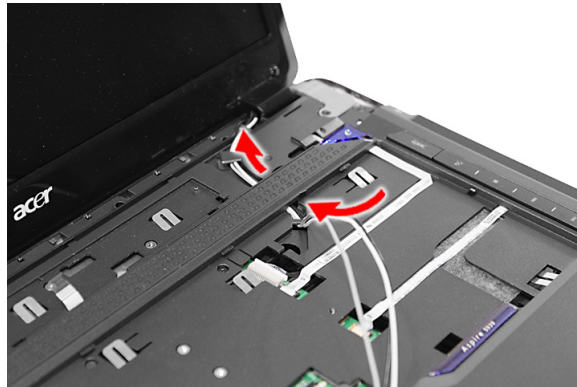

13. Disconnect the LCD cable connector from the main board.

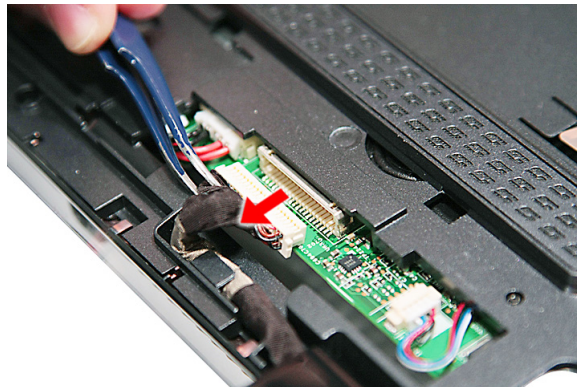

14. Remove the two screws (E) from the left and right hinge of the LCD module.

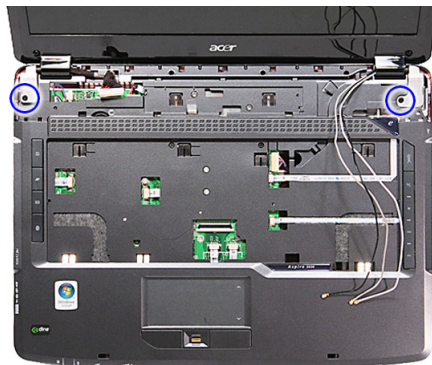

Step	Size (Quantity)	Color	Torque
1~2	M2.5 x L10 (2)	Black	4.0 kgf-cm

-
15. Carefully remove the LCD module from the base unit.



NOTE: When connecting the cable back to the unit, please note that the cable should be routed well.

Separating the Upper Case from the Lower Case

1. See “Removing the Battery Pack” on page 60.
2. See “Removing the SD dummy card” on page 61.
3. See “Removing the ExpressCard dummy card” on page 61.
4. See “Removing the Lower Cover” on page 62.
5. See “Removing the DIMM” on page 63.
6. See “Removing the WLAN Board Modules” on page 63.
7. See “Removing the TV Tuner Board Modules” on page 64.
8. See “Removing the Hard Disk Drive Module” on page 66.
9. See “Removing the Optical Drive Module” on page 68.
10. See “Removing the Keyboard” on page 72.
11. See “Removing the Middle Cover” on page 73.
12. See “Removing the Power Board” on page 74.
13. See “Removing the Heatsink Fan Module” on page 75.
14. See “Removing the CPU and VGA Heatsink Module” on page 76.
15. See “Removing the CPU” on page 77.
16. See “Removing the VGA Board (Discrete Model only)” on page 78.
17. See “Removing the LCD Module” on page 79.
18. Disconnect the touchpad cable from the TPAD1 connector on the main board.

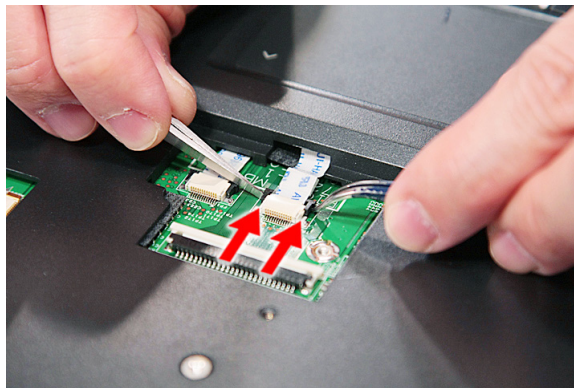



19. Disconnect the fingerprint cable from the FP1 connector on the main board.

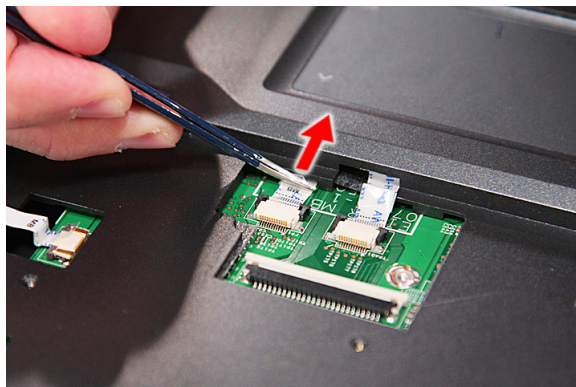
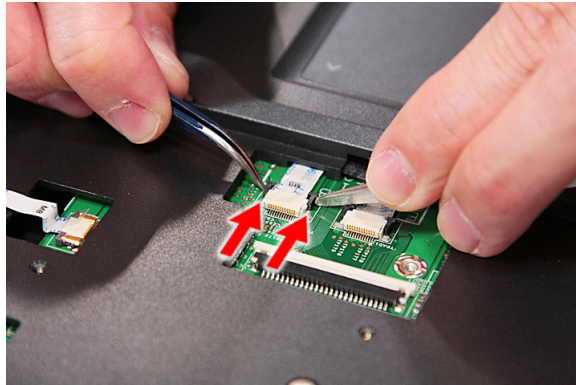

20. Disconnect the launch board cable from the LAUNCH1 connector on the main board.



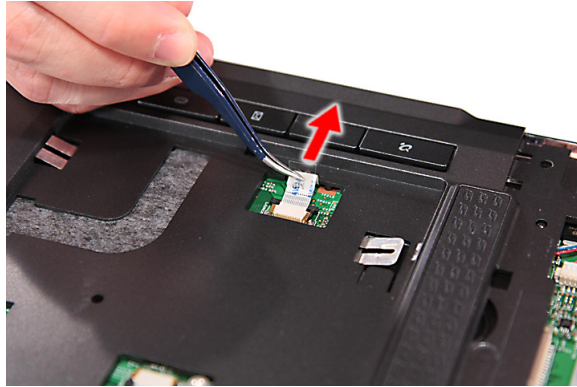

21. Disconnect the power cable from the PWRCN1 connector on the main board.

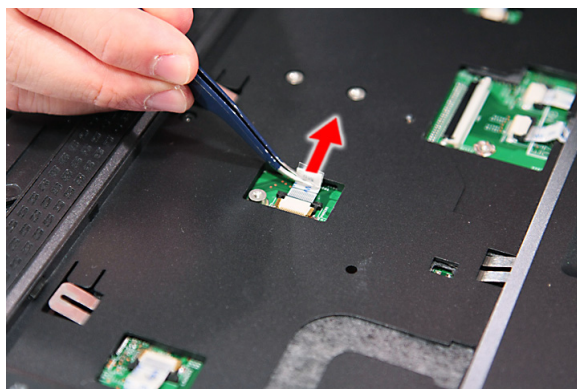
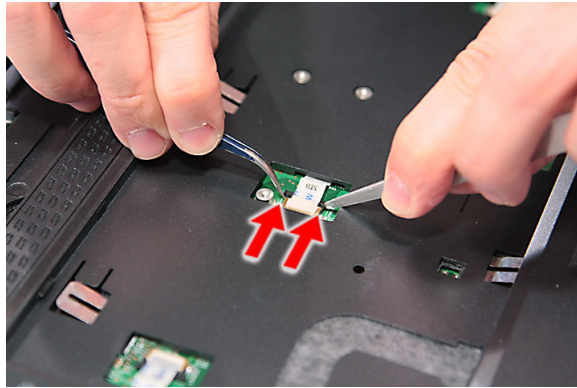

22. Disconnect the media board cable from the MEDIA1 connector on the main board.

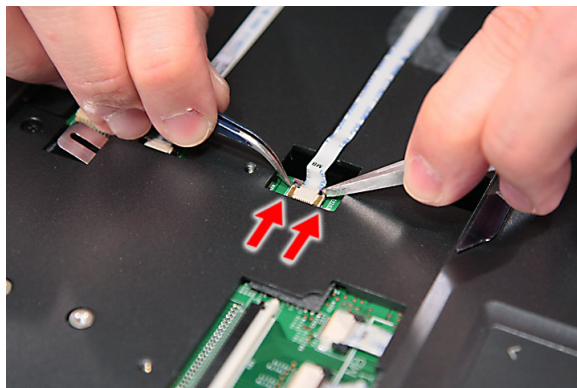

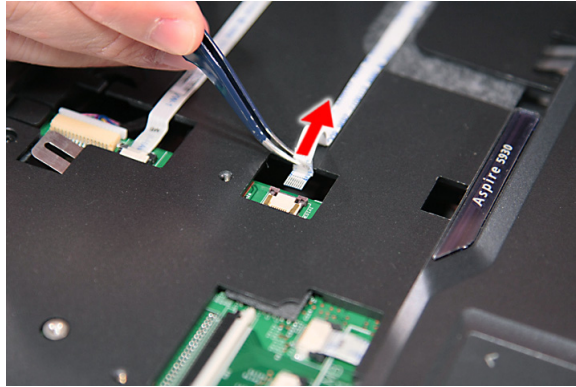

23. Disconnect the E-key connector from the main board.

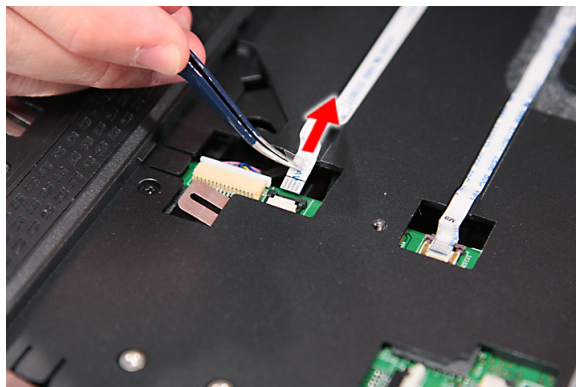
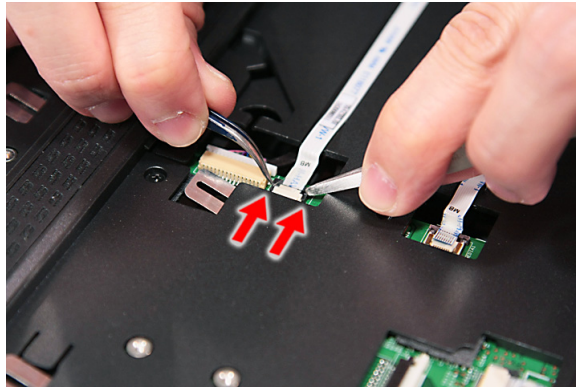

24. Disconnect the speaker cable from the INTSPK1 connector on the main board.

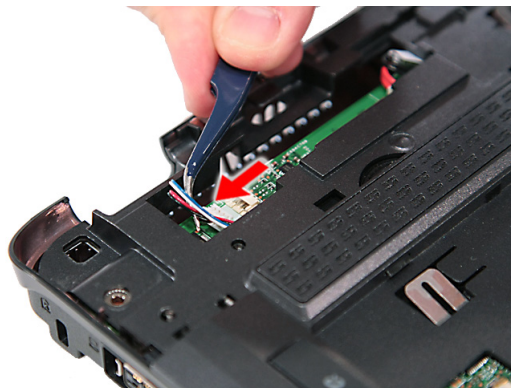

25. Remove the eleven screws (11 x B) from the bottom panel.

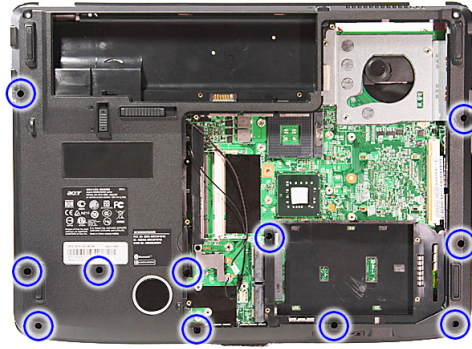

Step	Size (Quantity)	Color	Torque
1~11	M2.5 x L6 (11)	Black	3.0 kgf-cm

26. Turn the unit over and remove the 5 screws (2 x B, 3 x A) from the top panel.

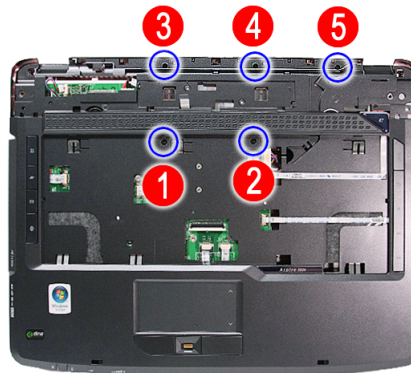

Step	Size (Quantity)	Color	Torque
1~2	M2.5 x L6 (2)	Black	3.0 kgf-cm
3~5	M2 x L4 (3)	Black	1.6 kgf-cm

27. Gently remove the upper case from the lower case.

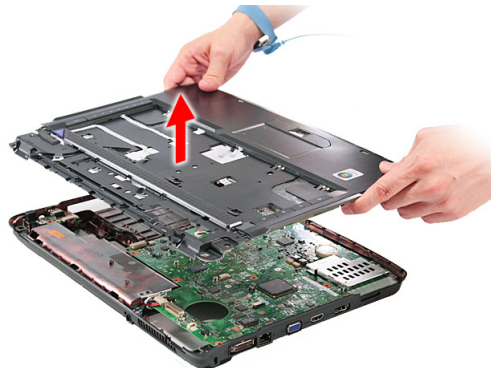

Removing the Media Board

1. See "Removing the Battery Pack" on page 60.
2. See "Removing the SD dummy card" on page 61.
3. See "Removing the ExpressCard dummy card" on page 61.
4. See "Removing the Lower Cover" on page 62.

-
5. See “Removing the DIMM” on page 63.
 6. See “Removing the WLAN Board Modules” on page 63.
 7. See “Removing the TV Tuner Board Modules” on page 64.
 8. See “Removing the Hard Disk Drive Module” on page 66.
 9. See “Removing the Optical Drive Module” on page 68.
 10. See “Removing the Keyboard” on page 72.
 11. See “Removing the Middle Cover” on page 73.
 12. See “Removing the Power Board” on page 74.
 13. See “Removing the Heatsink Fan Module” on page 75.
 14. See “Removing the CPU and VGA Heatsink Module” on page 76.
 15. See “Removing the CPU” on page 77.
 16. See “Removing the VGA Board (Discrete Model only)” on page 78.
 17. See “Removing the LCD Module” on page 79.
 18. See “Separating the Upper Case from the Lower Case” on page 81.
 19. Release the media board from the latches.

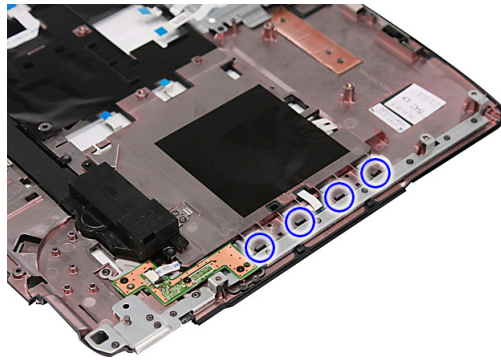

20. Turn over the media board to gain access to the cable.

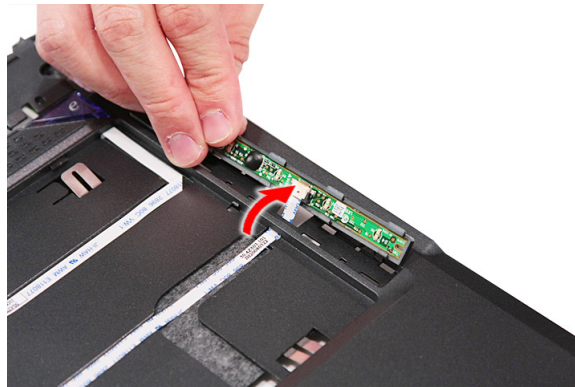

-
21. Disconnect the cable from the media board to remove the board from the upper case.

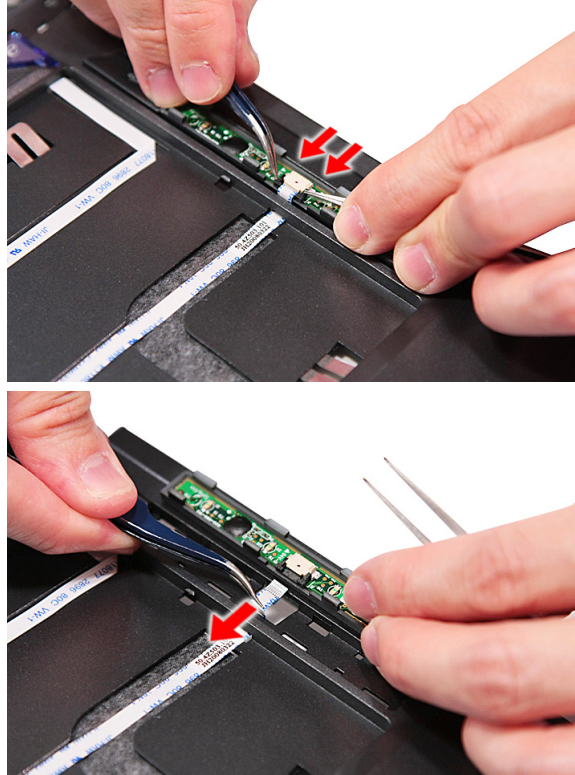

Removing the E-key Board

1. See "Removing the Battery Pack" on page 60.
2. See "Removing the SD dummy card" on page 61.
3. See "Removing the ExpressCard dummy card" on page 61.
4. See "Removing the Lower Cover" on page 62.
5. See "Removing the DIMM" on page 63.
6. See "Removing the WLAN Board Modules" on page 63.
7. See "Removing the TV Tuner Board Modules" on page 64.
8. See "Removing the Hard Disk Drive Module" on page 66.
9. See "Removing the Keyboard" on page 72.
10. See "Removing the Middle Cover" on page 73.
11. See "Removing the Power Board" on page 74.
12. See "Removing the Heatsink Fan Module" on page 75.
13. See "Removing the CPU and VGA Heatsink Module" on page 76.
14. See "Removing the CPU" on page 77.
15. See "Removing the VGA Board (Discrete Model only)" on page 78.
16. See "Removing the LCD Module" on page 79.
17. See "Separating the Upper Case from the Lower Case" on page 81.

18. Disconnect the cable from the E-key board.

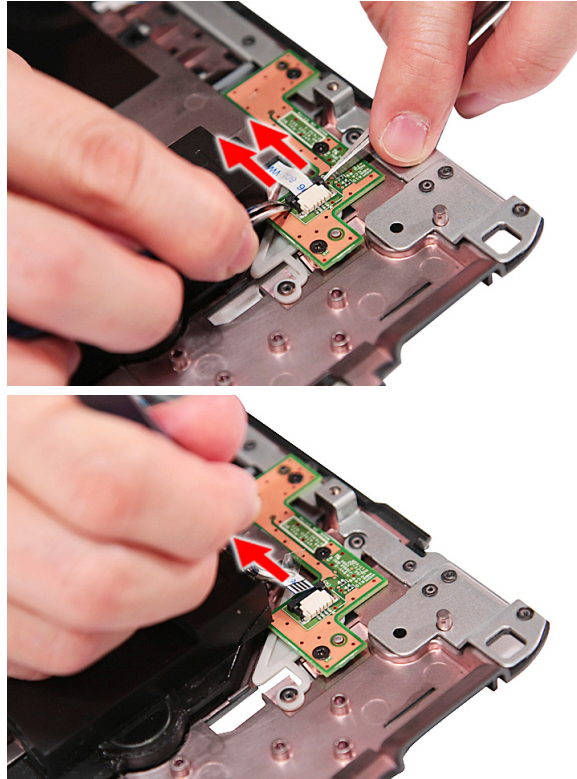

19. Remove the three screws (3 x A) securing the E-key board.

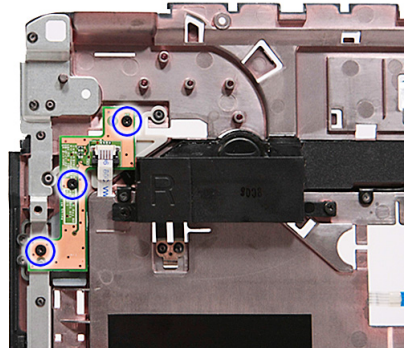

Step	Size (Quantity)	Color	Torque
1~3	M2 x L4 (3)	Black	1.6 kgf-cm

20. Remove the E-key board from the upper case.

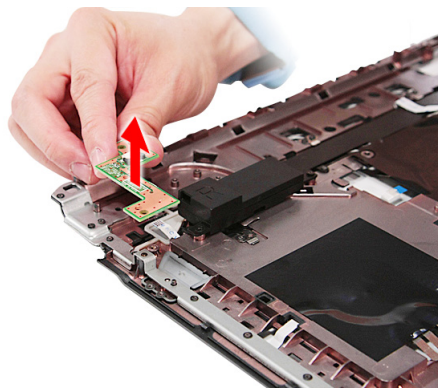

Removing the Speaker Module

1. See “Removing the Battery Pack” on page 60.
2. See “Removing the SD dummy card” on page 61.
3. See “Removing the ExpressCard dummy card” on page 61.
4. See “Removing the Lower Cover” on page 62.
5. See “Removing the DIMM” on page 63.
6. See “Removing the WLAN Board Modules” on page 63.
7. See “Removing the TV Tuner Board Modules” on page 64.
8. See “Removing the Hard Disk Drive Module” on page 66.
9. See “Removing the Keyboard” on page 72.
10. See “Removing the Middle Cover” on page 73.
11. See “Removing the Power Board” on page 74.
12. See “Removing the Heatsink Fan Module” on page 75.
13. See “Removing the CPU and VGA Heatsink Module” on page 76.
14. See “Removing the CPU” on page 77.
15. See “Removing the VGA Board (Discrete Model only)” on page 78.
16. See “Removing the LCD Module” on page 79.
17. See “Separating the Upper Case from the Lower Case” on page 81.
18. Remove the four screws (4 x A) securing the speaker module.

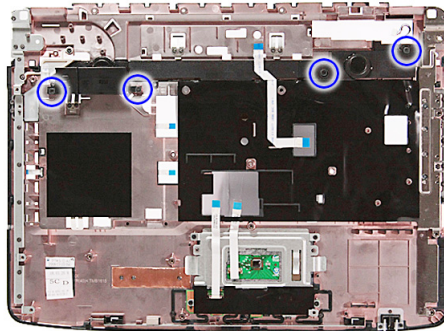

Step	Size (Quantity)	Color	Torque
1~4	M2 x L4 (4)	Black	1.6 kgf-cm

19. Remove the cable that is glued to the speaker module.

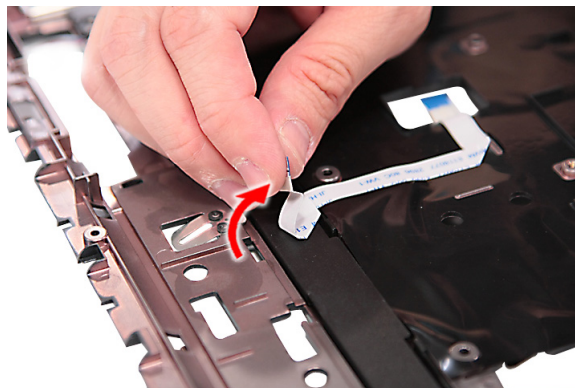

-
20. Remove the speaker module from the upper case.

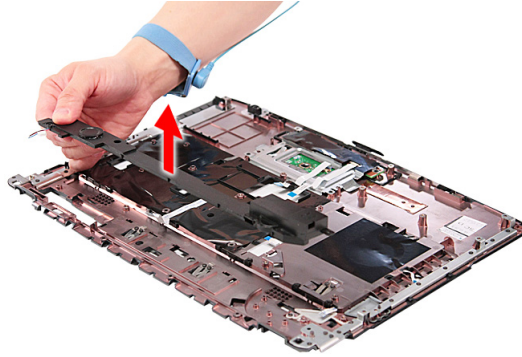

Removing the Launch Board

1. See “Removing the Battery Pack” on page 60.
2. See “Removing the SD dummy card” on page 61.
3. See “Removing the ExpressCard dummy card” on page 61.
4. See “Removing the Lower Cover” on page 62.
5. See “Removing the DIMM” on page 63.
6. See “Removing the WLAN Board Modules” on page 63.
7. See “Removing the TV Tuner Board Modules” on page 64.
8. See “Removing the Hard Disk Drive Module” on page 66.
9. See “Removing the Keyboard” on page 72.
10. See “Removing the Middle Cover” on page 73.
11. See “Removing the Power Board” on page 74.
12. See “Removing the Heatsink Fan Module” on page 75.
13. See “Removing the CPU and VGA Heatsink Module” on page 76.
14. See “Removing the CPU” on page 77.
15. See “Removing the VGA Board (Discrete Model only)” on page 78.
16. See “Removing the LCD Module” on page 79.
17. See “Separating the Upper Case from the Lower Case” on page 81.
18. Disconnect the cable from the launch board.

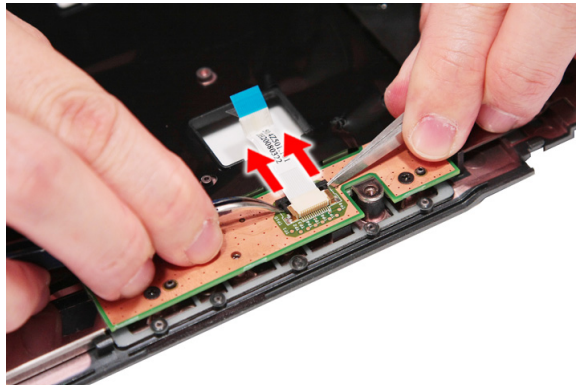

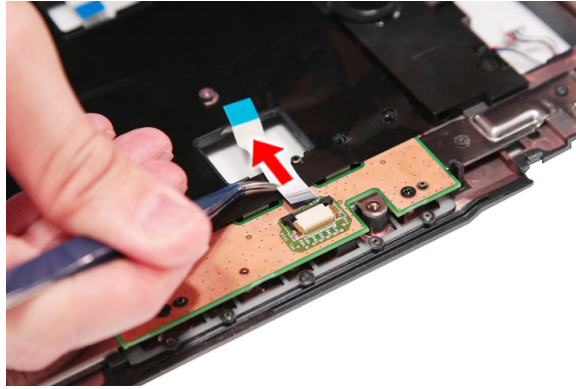

19. Remove the two screws (2 x A) securing the launch board module.

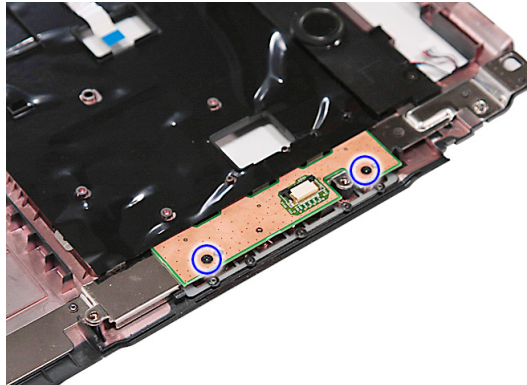

Step	Size (Quantity)	Color	Torque
1~2	M2 x L4 (2)	Black	1.6 kgf-cm

20. Remove the launch board module from the upper case.

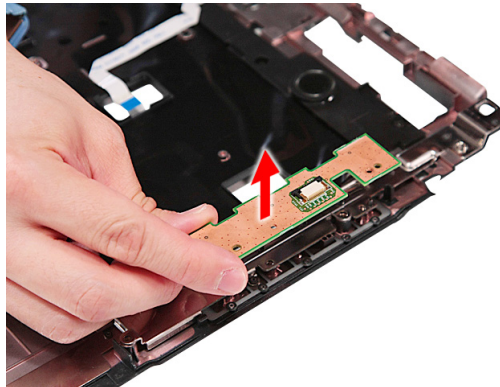

Removing the Fingerprint and Touchpad Module

1. See "Removing the Battery Pack" on page 60.
2. See "Removing the SD dummy card" on page 61.
3. See "Removing the ExpressCard dummy card" on page 61.
4. See "Removing the Lower Cover" on page 62.
5. See "Removing the DIMM" on page 63.
6. See "Removing the WLAN Board Modules" on page 63.
7. See "Removing the TV Tuner Board Modules" on page 64.

-
8. See “Removing the Hard Disk Drive Module” on page 66.
 9. See “Removing the Keyboard” on page 72.
 10. See “Removing the Middle Cover” on page 73.
 11. See “Removing the Power Board” on page 74.
 12. See “Removing the Heatsink Fan Module” on page 75.
 13. See “Removing the CPU and VGA Heatsink Module” on page 76.
 14. See “Removing the CPU” on page 77.
 15. See “Removing the VGA Board (Discrete Model only)” on page 78.
 16. See “Removing the LCD Module” on page 79.
 17. See “Separating the Upper Case from the Lower Case” on page 81.
 18. Remove the touchpad cable that is glued to the bracket.

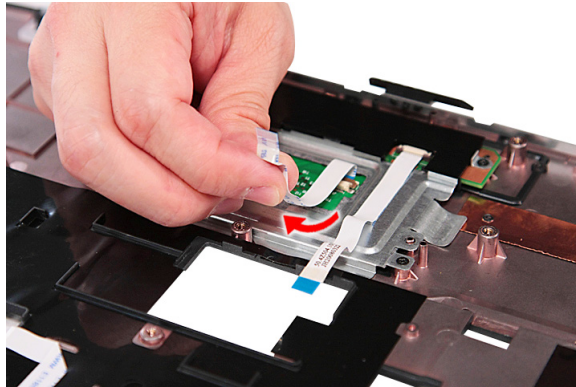

19. Disconnect the touchpad cable from the touchpad board.

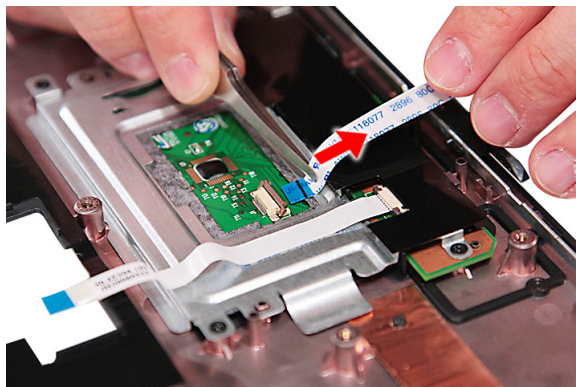
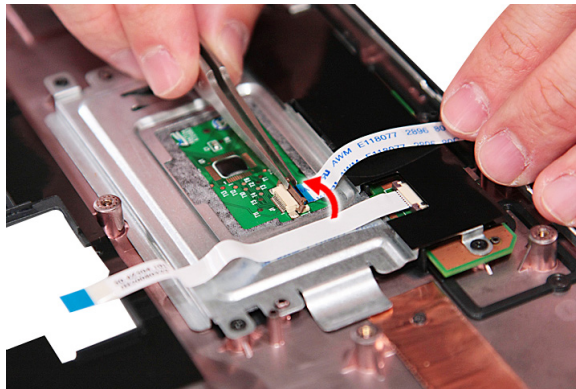

20. Disconnect the fingerprint cable from the fingerprint board.

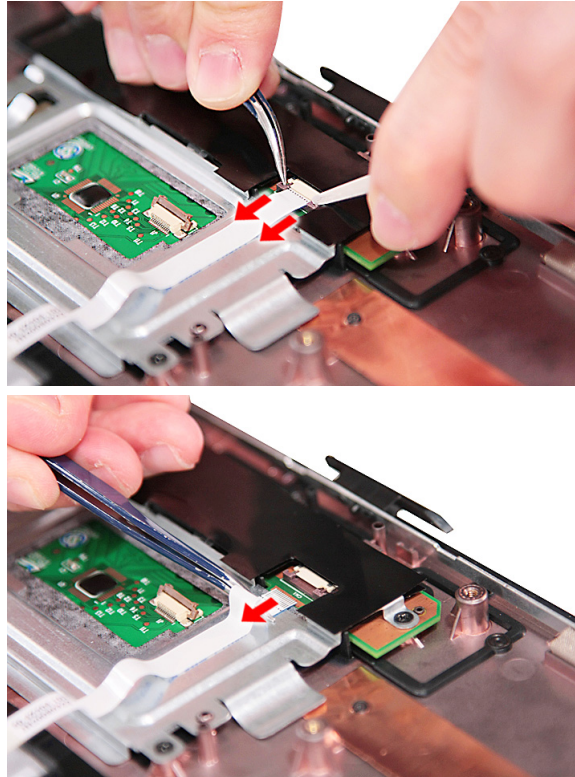

21. Remove the four screws (A) securing the bracket to the upper case.

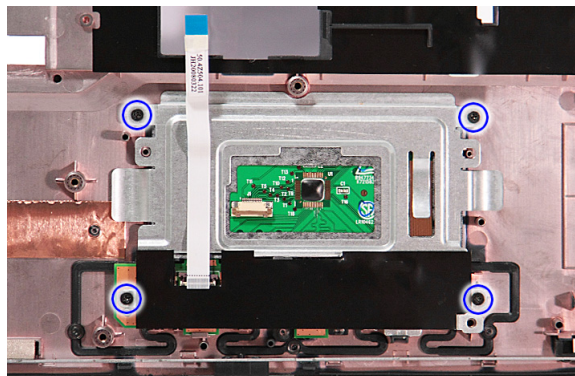

Step	Size (Quantity)	Color	Torque
1~4	M2 x L4 (4)	Black	1.6 kgf-cm

22. Remove the touchpad bracket.



23. Remove the fingerprint board module.

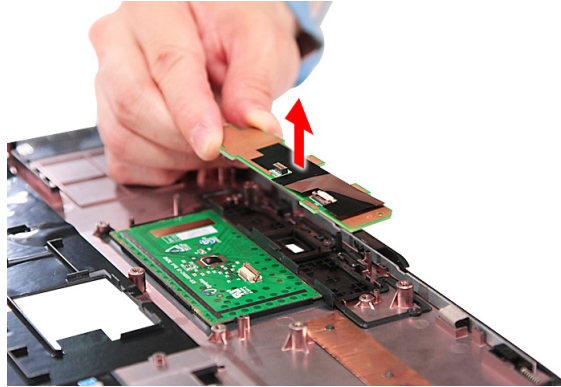

24. Carefully pry loose and remove the touch pad board.

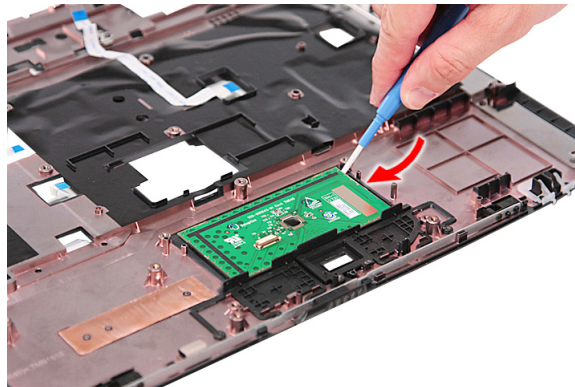

WARNING:The touchpad board is glued to the upper case, only remove the touchpad board if it is defective.

Removing the Main Board

1. See “Removing the Battery Pack” on page 60.
2. See “Removing the SD dummy card” on page 61.
3. See “Removing the ExpressCard dummy card” on page 61.
4. See “Removing the Lower Cover” on page 62.
5. See “Removing the DIMM” on page 63.
6. See “Removing the WLAN Board Modules” on page 63.
7. See “Removing the TV Tuner Board Modules” on page 64.
8. See “Removing the Hard Disk Drive Module” on page 66.
9. See “Removing the Optical Drive Module” on page 68.

-
10. See “Removing the Keyboard” on page 72.
 11. See “Removing the Middle Cover” on page 73.
 12. See “Removing the Power Board” on page 74.
 13. See “Removing the Heatsink Fan Module” on page 75.
 14. See “Removing the CPU and VGA Heatsink Module” on page 76.
 15. See “Removing the CPU” on page 77.
 16. See “Removing the VGA Board (Discrete Model only)” on page 78.
 17. See “Removing the LCD Module” on page 79.
 18. See “Separating the Upper Case from the Lower Case” on page 81.
 19. Disconnect the USB cable from the USBCN1 connector on the main board.

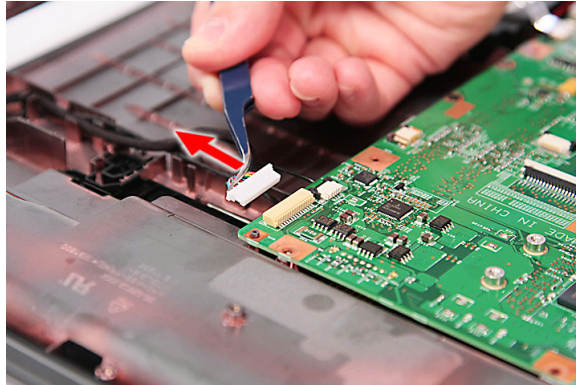

20. Disconnect the subwoofer cable from the SPKR1 connector on the main board.



21. Disconnect the bluetooth cable from the BLUE1 connector on the main board.

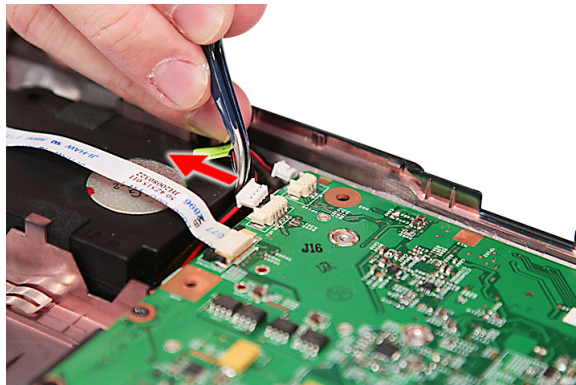

22. Disconnect the audio cable from the AUDIOCN1 connector on the main board.

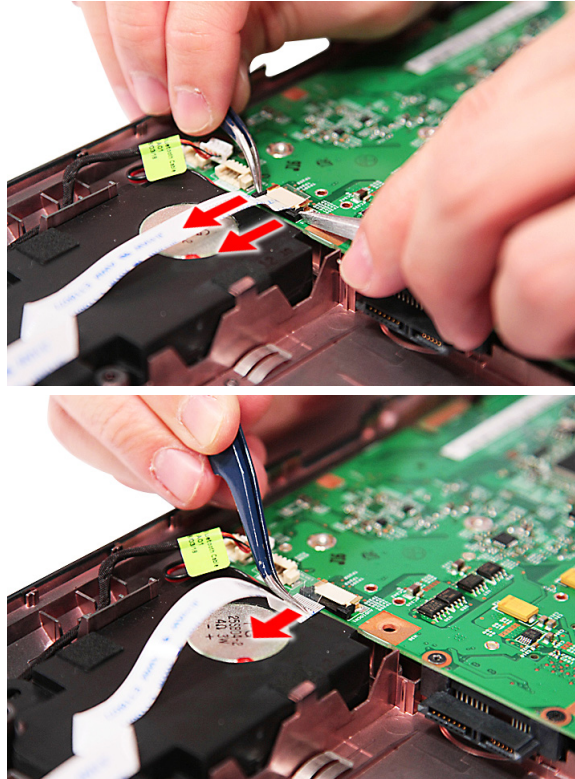

23. Disconnect the DC cable from the DC1 connector on the main board.



24. Remove the one screw (A) securing the main board in place.

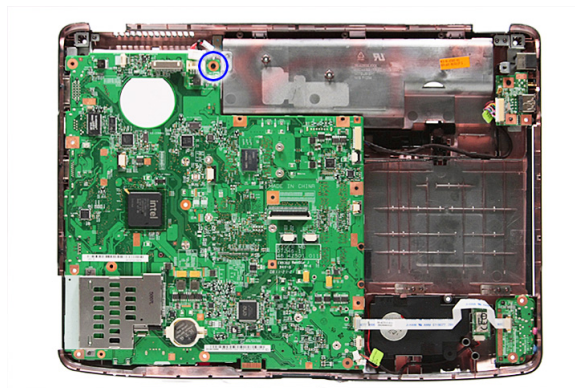

Step	Size (Quantity)	Color	Torque
1	M2 x L4 (1)	Black	1.6 kgf-cm

25. Carefully remove the main board.

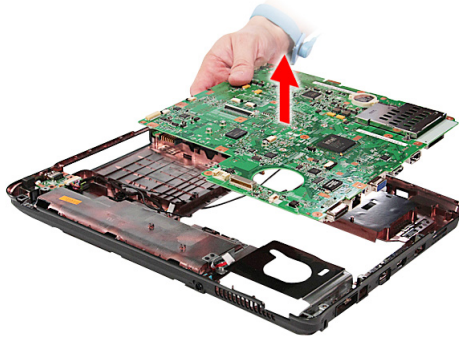

Removing the USB Board Module

1. See “Removing the Battery Pack” on page 60.
2. See “Removing the SD dummy card” on page 61.
3. See “Removing the ExpressCard dummy card” on page 61.
4. See “Removing the Lower Cover” on page 62.
5. See “Removing the DIMM” on page 63.
6. See “Removing the WLAN Board Modules” on page 63.
7. See “Removing the TV Tuner Board Modules” on page 64.
8. See “Removing the Hard Disk Drive Module” on page 66.
9. See “Removing the Keyboard” on page 72.
10. See “Removing the Middle Cover” on page 73.
11. See “Removing the Power Board” on page 74.
12. See “Removing the Heatsink Fan Module” on page 75.
13. See “Removing the CPU and VGA Heatsink Module” on page 76.
14. See “Removing the CPU” on page 77.
15. See “Removing the VGA Board (Discrete Model only)” on page 78.
16. See “Removing the LCD Module” on page 79.
17. See “Separating the Upper Case from the Lower Case” on page 81.
18. Disconnect the TV tuner antenna cable and the USB cable from the USB board module.



19. Remove the one screw (A) securing the USB board module to the lower case.



Step	Size (Quantity)	Color	Torque
1	M2 x L4 (1)	Black	1.6 kgf-cm

20. Remove the USB board module from the lower case.

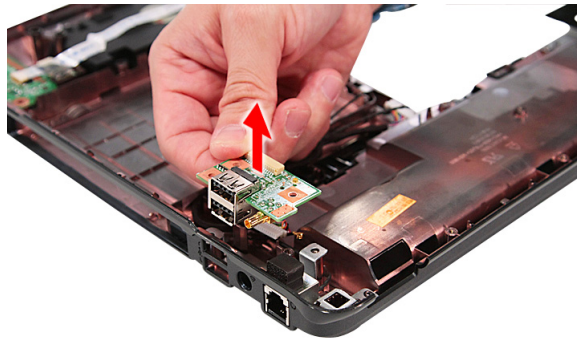

Removing the Audio Board Module

1. See “Removing the Battery Pack” on page 60.
2. See “Removing the SD dummy card” on page 61.
3. See “Removing the ExpressCard dummy card” on page 61.
4. See “Removing the Lower Cover” on page 62.
5. See “Removing the DIMM” on page 63.
6. See “Removing the WLAN Board Modules” on page 63.
7. See “Removing the TV Tuner Board Modules” on page 64.
8. See “Removing the Hard Disk Drive Module” on page 66.
9. See “Removing the Keyboard” on page 72.
10. See “Removing the Middle Cover” on page 73.
11. See “Removing the Power Board” on page 74.
12. See “Removing the Heatsink Fan Module” on page 75.
13. See “Removing the CPU and VGA Heatsink Module” on page 76.
14. See “Removing the CPU” on page 77.
15. See “Removing the VGA Board (Discrete Model only)” on page 78.
16. See “Removing the LCD Module” on page 79.
17. See “Separating the Upper Case from the Lower Case” on page 81.

-
18. Disconnect the cable from the audio board module and remove it from the subwoofer (the cable is glued to the subwoofer).

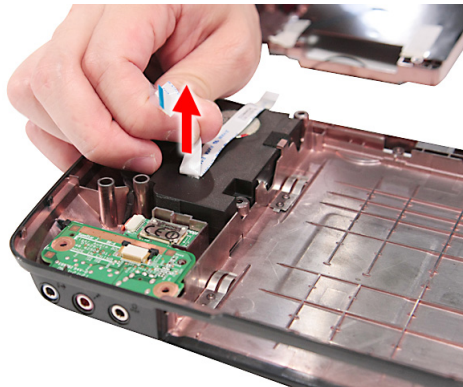
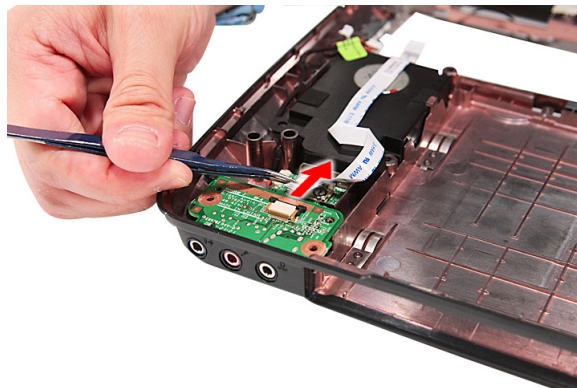

19. Release the audio board module from the latch and remove the audio board module from the lower case.

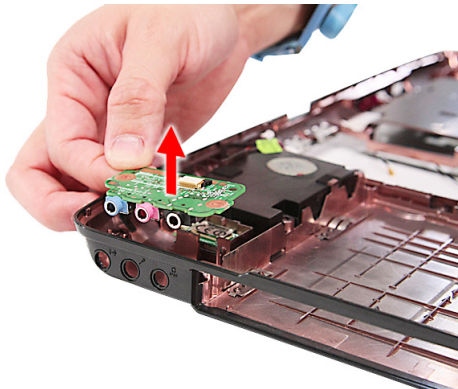

Removing the Subwoofer and the Bluetooth Modules

1. See “Removing the Battery Pack” on page 60.
2. See “Removing the SD dummy card” on page 61.
3. See “Removing the ExpressCard dummy card” on page 61.
4. See “Removing the Lower Cover” on page 62.
5. See “Removing the DIMM” on page 63.
6. See “Removing the WLAN Board Modules” on page 63.
7. See “Removing the TV Tuner Board Modules” on page 64.
8. See “Removing the Hard Disk Drive Module” on page 66.
9. See “Removing the Keyboard” on page 72.
10. See “Removing the Middle Cover” on page 73.
11. See “Removing the Power Board” on page 74.
12. See “Removing the Heatsink Fan Module” on page 75.
13. See “Removing the CPU and VGA Heatsink Module” on page 76.
14. See “Removing the CPU” on page 77.
15. See “Removing the VGA Board (Discrete Model only)” on page 78.
16. See “Removing the LCD Module” on page 79.
17. See “Separating the Upper Case from the Lower Case” on page 81.
18. See “Removing the Audio Board Module” on page 98.
19. Release the subwoofer module from the latch and remove the subwoofer module from the lower case.

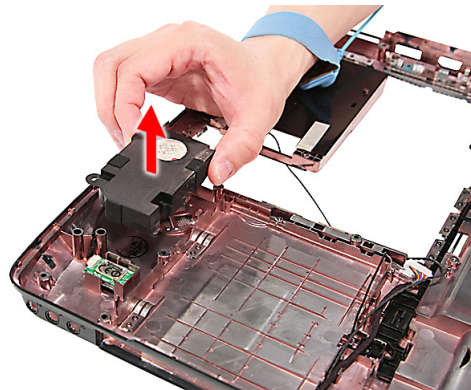
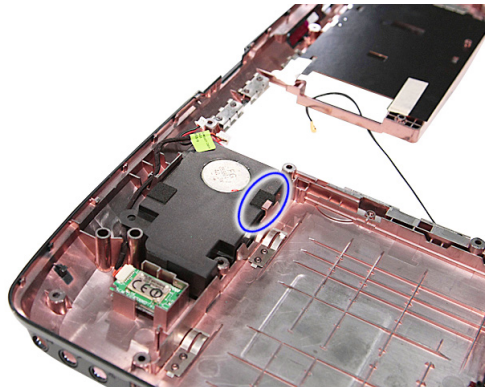

20. Remove the bluetooth module from the lower case.



LCD Module Disassembly Process

LCD Module Disassembly Flowchart

LCD MODULE DISASSEMBLY

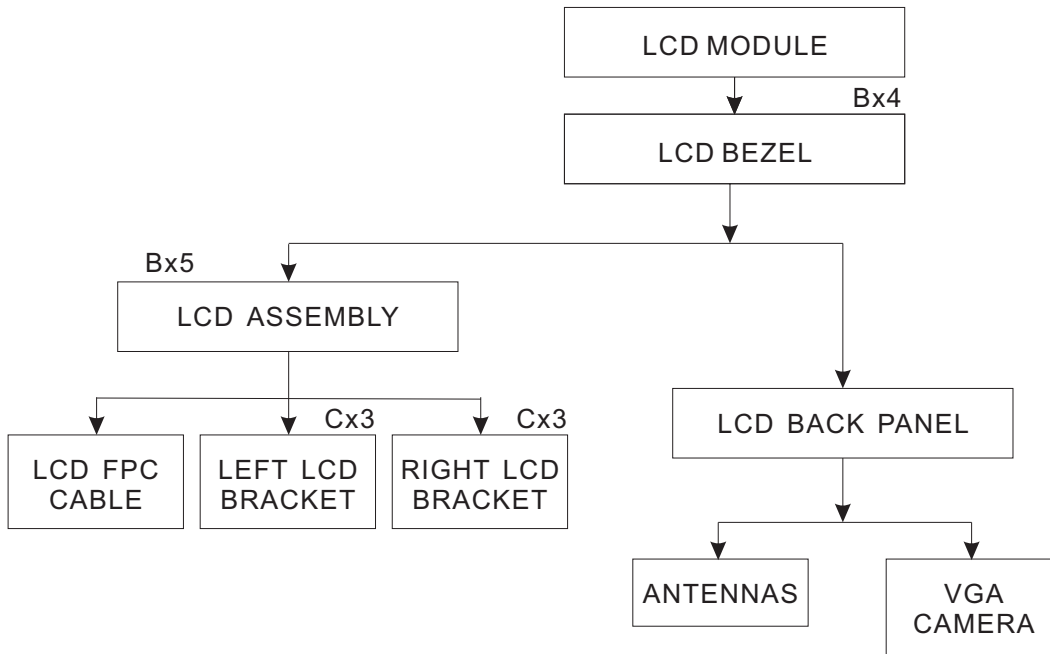

Screw List

Item	Screw	Color	Part No.
B	M2.5 x L6	Black	86.00E12.536
C	M2 x L3	Black	86.9A522.3R0

Removing the LCD Bezel

1. See “Removing the Battery Pack” on page 60.
2. See “Removing the Lower Cover” on page 62.
3. See “Removing the DIMM” on page 63.
4. See “Removing the WLAN Board Modules” on page 63.
5. See “Removing the TV Tuner Board Modules” on page 64.
6. See “Removing the Keyboard” on page 72.
7. See “Removing the Middle Cover” on page 73.
8. See “Removing the LCD Module” on page 79.
9. Remove the four screw covers from the LCD bezel.



10. Remove the four screws (B) on the LCD module as shown.



Step	Size (Quantity)	Color	Torque
1~4	M2.5 x L6 (4)	Black	3.0 kgf-cm

11. Carefully pry open the LCD bezel and place the bezel on top of the LCD panel.





WARNING: Be careful when trying to lift up the LCD bezel. The top of the LCD bezel is glued to the LCD module.

12. Disconnect the microphone cable and remove the bezel from the LCD panel.

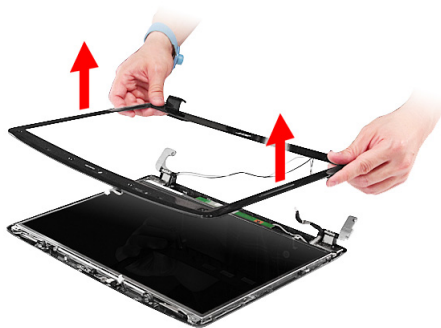

Removing the LCD module with the Brackets

1. See "Removing the Battery Pack" on page 60.
2. See "Removing the Lower Cover" on page 62.
3. See "Removing the DIMM" on page 63.
4. See "Removing the WLAN Board Modules" on page 63.
5. See "Removing the TV Tuner Board Modules" on page 64.
6. See "Removing the Keyboard" on page 72.
7. See "Removing the Middle Cover" on page 73.

8. See "Removing the LCD Module" on page 79.
9. See "Removing the LCD Bezel" on page 103.
10. Disconnect the cable from the web camera.



11. Disconnect the backlight cable from the connector.



12. Remove the five screws (5 x B) securing the LCD module.

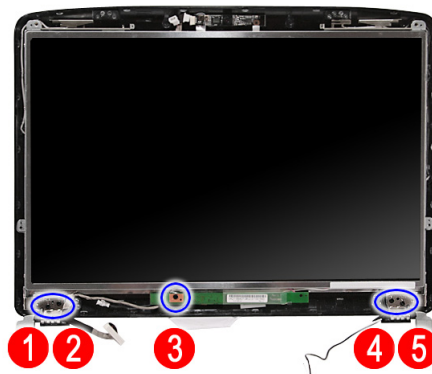

Step	Size (Quantity)	Color	Torque
1~5	M2.5 x L6 (5)	Black	3.0 kgf-cm

-
13. Remove the LCD with the brackets from the back cover.



Removing the FPC Cable

1. See “Removing the Battery Pack” on page 60.
2. See “Removing the Lower Cover” on page 62.
3. See “Removing the DIMM” on page 63.
4. See “Removing the WLAN Board Modules” on page 63.
5. See “Removing the TV Tuner Board Modules” on page 64.
6. See “Removing the Keyboard” on page 72.
7. See “Removing the Middle Cover” on page 73.
8. See “Removing the LCD Module” on page 79.
9. See “Removing the LCD Bezel” on page 103.
10. See “Removing the LCD module with the Brackets” on page 104.
11. Disconnect the cables from the inverter board.

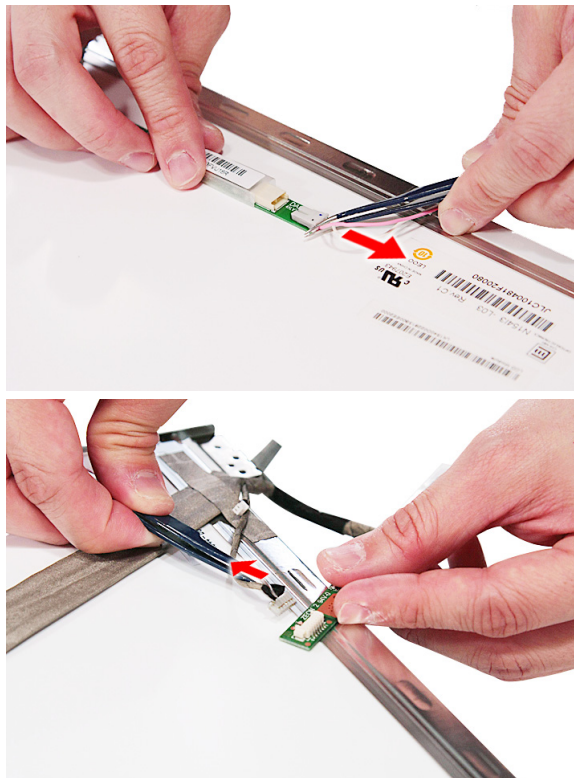

12. Detach any adhesive tapes and any cable that is glued to the LCD panel.

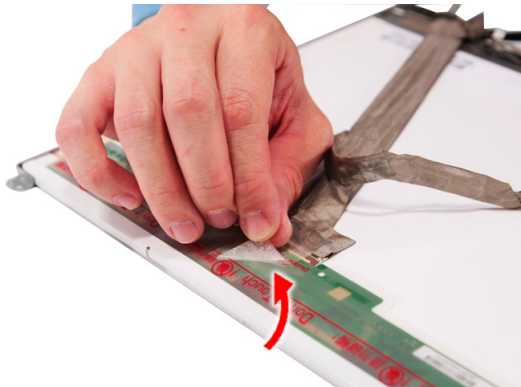

13. Disconnect the FPC cable from the LCD panel.



Removing the LCD Brackets

1. See "Removing the Battery Pack" on page 60.

2. See “Removing the Lower Cover” on page 62.
3. See “Removing the WLAN Board Modules” on page 63.
4. See “Removing the Keyboard” on page 72.
5. See “Removing the Middle Cover” on page 73.
6. See “Removing the LCD Module” on page 79.
7. See “Removing the LCD Bezel” on page 103.
8. See “Removing the LCD module with the Brackets” on page 104.
9. See “Removing the FPC Cable” on page 106.
10. Remove the six screws (6 x C) securing the left and right LCD brackets to remove the brackets.



Step	Size (Quantity)	Color	Torque
1~6	M2 x L4 (6)	Silver	1.6 kgf-cm

Removing the Antennas

1. See “Removing the Battery Pack” on page 60.
2. See “Removing the Lower Cover” on page 62.
3. See “Removing the WLAN Board Modules” on page 63.
4. See “Removing the Keyboard” on page 72.
5. See “Removing the Middle Cover” on page 73.
6. See “Removing the LCD Module” on page 79.
7. See “Removing the LCD Bezel” on page 103.
8. See “Removing the LCD module with the Brackets” on page 104.
9. Release the antenna cables from the aluminium tapes.

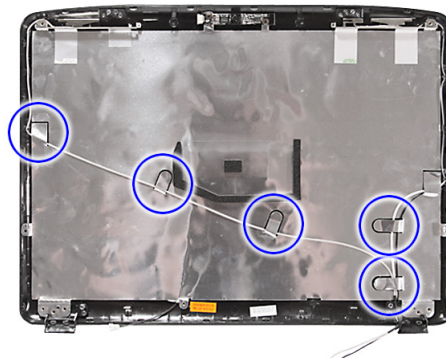

-
10. Remove the tapes together holding the antenna in place.



11. Remove the antenna cables from the back cover.

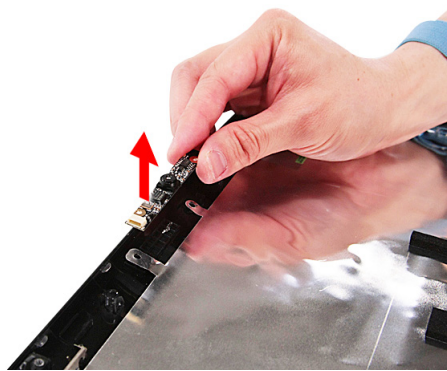

NOTE: There is no need to remove the antenna unless you really need to replace it.

Removing the Web Camera

1. See “Removing the Battery Pack” on page 60.
2. See “Removing the Lower Cover” on page 62.
3. See “Removing the WLAN Board Modules” on page 63.
4. See “Removing the Keyboard” on page 72.
5. See “Removing the Middle Cover” on page 73.
6. See “Removing the LCD Module” on page 79.
7. See “Removing the LCD Bezel” on page 103.
8. See “Removing the LCD module with the Brackets” on page 104.

-
9. Remove the Web camera from the back cover.

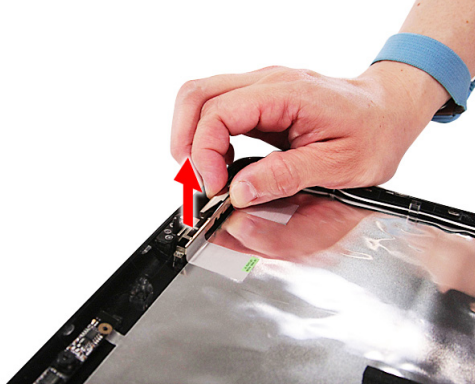

Troubleshooting

Use the following procedure as a guide for computer problems.

NOTE: The diagnostic tests are intended to test only Acer products. Non-Acer products, prototype cards, or modified options can give false errors and invalid system responses.

1. Obtain the failing symptoms in as much detail as possible.
2. Verify the symptoms by attempting to re-create the failure by running the diagnostic test or by repeating the same operation.
3. Use the following table with the verified symptom to determine which page to go to.

Symptoms (Verified)	Go To
Power failure. (The power indicator does not go on or stay on.)	"Power System Check" on page 113.
POST does not complete. No beep or error codes are indicated.	"Power-On Self-Test (POST) Error Message" on page 116 "Undetermined Problems" on page 130
POST detects an error and displayed messages on screen.	"Error Message List" on page 117
Other symptoms (i.e. LCD display problems or others).	"Power-On Self-Test (POST) Error Message" on page 116
Symptoms cannot be re-created (intermittent problems).	Use the customer-reported symptoms and go to "Power-On Self-Test (POST) Error Message" on page 116 "Intermittent Problems" on page 129 "Undetermined Problems" on page 130

System Check Procedures

External Diskette Drive Check

Do the following to isolate the problem to a controller, driver, or diskette. A write-enabled, diagnostic diskette is required.

NOTE: Make sure that the diskette does not have more than one label attached to it. Multiple labels can cause damage to the drive or cause the drive to fail.

Do the following to select the test device.

1. Boot from the diagnostics diskette and start the diagnostics program.
2. See if FDD Test is passed as the program runs to FDD Test.
3. Follow the instructions in the message window.

If an error occurs with the internal diskette drive, reconnect the diskette connector on the system board.

If the error still remains:

1. Reconnect the external diskette drive/DVD-ROM module.
2. Replace the external diskette drive/CD-ROM module.
3. Replace the main board.

External CD-ROM Drive Check

Do the following to isolate the problem to a controller, drive, or CD-ROM. Make sure that the CD-ROM does not have any label attached to it. The label can cause damage to the drive or can cause the drive to fail.

Do the following to select the test device:

1. Boot from the diagnostics diskette and start the diagnostics program.
2. See if CD-ROM Test is passed when the program runs to CD-ROM Test.
3. Follow the instructions in the message window.

If an error occurs, reconnect the connector on the System board. If the error still remains:

1. Reconnect the external diskette drive/CD-ROM module.
2. Replace the external diskette drive/CD-ROM module.
3. Replace the main board.

Keyboard or Auxiliary Input Device Check

Remove the external keyboard if the internal keyboard is to be tested.

If the internal keyboard does not work or an unexpected character appears, make sure that the flexible cable extending from the keyboard is correctly seated in the connector on the system board.

If the keyboard cable connection is correct, run the Keyboard Test.

If the tests detect a keyboard problem, do the following one at a time to correct the problem. Do not replace a non-defective FRU:

1. Reconnect the keyboard cables.
2. Replace the keyboard.
3. Replace the main board.

The following auxiliary input devices are supported by this computer:

- Numeric keypad

-
- External keyboard

If any of these devices do not work, reconnect the cable connector and repeat the failing operation.

Memory check

Memory errors might stop system operations, show error messages on the screen, or hang the system.

1. Boot from the diagnostics diskette and start the diagnostic program (please refer to main board).
2. Go to the diagnostic memory in the test items.
3. Press F2 in the test items.
4. Follow the instructions in the message window.

NOTE: Make sure that the DIMM is fully installed into the connector. A loose connection can cause an error.

Power System Check

To verify the symptom of the problem, power on the computer using each of the following power sources:

1. Remove the battery pack.
2. Connect the power adapter and check that power is supplied.
3. Disconnect the power adapter and install the charged battery pack; then check that power is supplied by the battery pack.

If you suspect a power problem, see the appropriate power supply check in the following list:

- "Check the Power Adapter" on page 114
- "Check the Battery Pack" on page 115

Check the Power Adapter

Unplug the power adapter cable from the computer and measure the output voltage at the plug of the power adapter cable. See the following figure

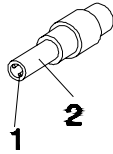

Pin 1: +19 to +20.5V

Pin 2: 0V, Ground

1. If the voltage is not correct, replace the power adapter.
2. If the voltage is within the range, do the following:
 - Replace the System board.
 - If the problem is not corrected, see “Undetermined Problems” on page 130.
 - If the voltage is not correct, go to the next step.

NOTE: An audible noise from the power adapter does not always indicate a defect.

3. If the power-on indicator does not light up, check the power cord of the power adapter for correct continuity and installation.
4. If the operational charge does not work, see “Check the Battery Pack” on page 115.

Check the Battery Pack

To check the battery pack, do the following:

From Software:

1. Check out the Power Management in control Panel
2. In Power Meter, confirm that if the parameters shown in the screen for Current Power Source and Total Battery Power Remaining are correct.
3. Repeat the steps 1 and 2, for both battery and adapter.
4. This helps you identify first the problem is on recharging or discharging.

From Hardware:

1. Power off the computer.
2. Remove the battery pack and measure the voltage between battery terminals 1(+) and 6(ground).
3. If the voltage is still less than 7.5 Vdc after recharging, replace the battery.

To check the battery charge operation, use a discharged battery pack or a battery pack that has less than 50% of the total power remaining when installed in the computer.

If the battery status indicator does not light up, remove the battery pack and let it return to room temperature. Re-install the battery pack.

If the charge indicator still does not light up, replace the battery pack. If the charge indicator still does not light up, replace the DC/DC charger board.

Touchpad Check

If the touchpad doesn't work, do the following actions one at a time to correct the problem. Do not replace a non-defective FRU:

1. Reconnect the touchpad cables.
2. Replace the touchpad.
3. Replace the system board.

After you use the touchpad, the pointer drifts on the screen for a short time. This self-acting pointer movement can occur when a slight, steady pressure is applied to the touchpad pointer. This symptom is not a hardware problem. No service actions are necessary if the pointer movement stops in a short period of time.

Power-On Self-Test (POST) Error Message

The POST error message index lists the error message and their possible causes. The most likely cause is listed first.

NOTE: Perform the FRU replacement or actions in the sequence shown in FRU/Action column, if the FRU replacement does not solve the problem, put the original part back in the computer. Do not replace a non-defective FRU.

This index can also help you determine the next possible FRU to be replaced when servicing a computer.

If the symptom is not listed, see “Undetermined Problems” on page 130.

The following lists the error messages that the BIOS displays on the screen and the error symptoms classified by function.

NOTE: Most of the error messages occur during POST. Some of them display information about a hardware device, e.g., the amount of memory installed. Others may indicate a problem with a device, such as the way it has been configured.

NOTE: If the system fails after you make changes in the BIOS Setup Utility menus, reset the computer, enter Setup and install Setup defaults or correct the error.

Index of Error Messages

Error Code List

Error Codes	Error Messages
006	Equipment Configuration Error Causes: 1. CPU BIOS Update Code Mismatch 2. IDE Primary Channel Master Drive Error (The causes will be shown before "Equipment Configuration Error")
010	Memory Error at xxxx:xxx:xxxxh (R:xxxxh, W:xxxxh)
070	Real Time Clock Error
071	CMOS Battery Bad
072	CMOS Checksum Error
110	System disabled. Incorrect password is specified.
<No error code>	Battery critical LOW In this situation BIOS will issue 4 short beeps then shut down system, no message will show.
<No error code>	Thermal critical High In this situation BIOS will shut down system, not show message.

Error Message List

Error Messages	FRU/Action in Sequence
Failure Fixed Disk	Reconnect hard disk drive connector. "Load Default Settings" in BIOS Setup Utility. Hard disk drive System board
Stuck Key	see "Keyboard or Auxiliary Input Device Check" on page 112.
Keyboard error	see "Keyboard or Auxiliary Input Device Check" on page 112.
Keyboard Controller Failed	see "Keyboard or Auxiliary Input Device Check" on page 112.
Keyboard locked - Unlock key switch	Unlock external keyboard
Monitor type does not match CMOS - Run Setup	Run "Load Default Settings" in BIOS Setup Utility.
Shadow RAM Failed at offset: nnnn	BIOS ROM System board
System RAM Failed at offset: nnnn	DIMM System board
Extended RAM Failed at offset: nnnn	DIMM System board
System battery is dead - Replace and run Setup	Replace RTC battery and Run BIOS Setup Utility to reconfigure system time, then reboot system.
System CMOS checksum bad - Default configuration used	RTC battery Run BIOS Setup Utility to reconfigure system time, then reboot system.

Error Message List

Error Messages	FRU/Action in Sequence
System timer error	RTC battery Run BIOS Setup Utility to reconfigure system time, then reboot system. System board
Real time clock error	RTC battery Run BIOS Setup Utility to reconfigure system time, then reboot system. System board
Previous boot incomplete - Default configuration used	Run "Load Default Settings" in BIOS Setup Utility. RTC battery System board
Memory size found by POST differed from CMOS	Run "Load Default Settings" in BIOS Setup Utility. DIMM System board
Diskette drive A error	Check the drive is defined with the proper diskette type in BIOS Setup Utility See "External Diskette Drive Check" on page 112.
Incorrect Drive A type - run SETUP	Check the drive is defined with the proper diskette type in BIOS Setup Utility
System cache error - Cache disabled	System board
CPU ID:	System board
DMA Test Failed	DIMM System board
Software NMI Failed	DIMM System board
Fail-Safe Timer NMI Failed	DIMM System board
Device Address Conflict	Run "Load Default Settings" in BIOS Setup Utility. RTC battery System board
Allocation Error for device	Run "Load Default Settings" in BIOS Setup Utility. RTC battery System board
Failing Bits: nnnn	DIMM BIOS ROM System board
Fixed Disk n	None
Invalid System Configuration Data	BIOS ROM System board
I/O device IRQ conflict	Run "Load Default Settings" in BIOS Setup Utility. RTC battery System board
Operating system not found	Enter Setup and see if fixed disk and drive A: are properly identified. Diskette drive Hard disk drive System board

Error Message List

No beep Error Messages	FRU/Action in Sequence
No beep, power-on indicator turns off and LCD is blank.	Power source (battery pack and power adapter). See "Power System Check" on page 113.. Ensure every connector is connected tightly and correctly. Reconnect the DIMM. LED board. System board.
No beep, power-on indicator turns on and LCD is blank.	Power source (battery pack and power adapter). See "Power System Check" on page 113.. Reconnect the LCD connector Hard disk drive LCD inverter ID LCD cable LCD Inverter LCD System board
No beep, power-on indicator turns on and LCD is blank. But you can see POST on an external CRT.	Reconnect the LCD connectors. LCD inverter ID LCD cable LCD inverter LCD System board
No beep, power-on indicator turns on and a blinking cursor shown on LCD during POST.	Ensure every connector is connected tightly and correctly. System board
No beep during POST but system runs correctly.	Speaker System board

Phoenix BIOS Beep Codes

Code	Beeps	POST Routine Description
02h		Verify Real Mode
03h		Disable Non-Maskable Interrupt (NMI)
04h		Get CPU type
06h		Initialize system hardware
08h		Initialize chipset with initial POST values
09h		Set IN POST flag
0Ah		Initialize CPU registers
0Bh		Enable CPU cache
0Ch		Initialize caches to initial POST values
0Eh		Initialize I/O component
0Fh		Initialize the local bus IDE
10h		Initialize Power Management
11h		Load alternate registers with initial POST values
12h		Restore CPU control word during warm boot
13h		Initialize PCI Bus Mastering devices
14h		Initialize keyboard controller
16h	1-2-2-3	BIOS ROM checksum
17h		Initialize cache before memory autosize
18h		8254 timer initialization
1Ah		8237 DMA controller initialization
1Ch		Reset Programmable Interrupt Controller
20h	1-3-1-1	Test DRAM refresh
22h	1-3-1-3	Test 8742 Keyboard Controller
24h		Set ES segment register to 4 GB
26h		Enable A20 line
28h		Autosize DRAM
29h		Initialize POST Memory Manager
2Ah		Clear 215 KB base RAM
2Ch	1-3-4-1	RAM failure on address line xxxx
2Eh	1-3-4-3	RAM failure on data bits xxxx of low byte of memory bus
2Fh		Enable cache before system BIOS shadow
30h	1-4-1-1	RAM failure on data bits xxxx of high byte of memory bus
32h		Test CPU bus-clock frequency
33h		Initialize Phoenix Dispatch Manager
36h		Warm start shut down
38h		Shadow system BIOS ROM
3Ah		Autosize cache

Code	Beeps	POST Routine Description
3Ch		Advanced configuration of chipset registers
3Dh		Load alternate registers with CMOS values
42h		Initialize interrupt vectors
45h		POST device initialization
46h	2-1-2-3	Check ROM copyright notice
48h		Check video configuration against CMOS
49h		Initialize PCI bus and devices
4Ah		Initialize all video adapters in system
4Bh		QuietBoot start (optional)
4Ch		Shadow video BIOS ROM
4Eh		Display BIOS copyright notice
50h		Display CPU type and speed
51h		Initialize EISA board
52h		Test keyboard
54h		Set key click if enabled
58h	2-2-3-1	Test for unexpected interrupts
59h		Initialize POST display service
5Ah		Display prompt "Press F2 to enter SETUP"
5Bh		Disable CPU cache
5Ch		Test RAM between 512 and 640 KB
60h		Test extended memory
62h		Test extended memory address lines
64h		Jump to User Patch1
66h		Configure advanced cache registers
67h		Initialize Multi Processor APIC
68h		Enable external and CPU caches
69h		Setup System Management Mode (SMM) area
6Ah		Display external L2 cache size
6Bh		Load custom defaults (optional)
6Ch		Display shadow-area message
6Eh		Display possible high address for UMB recovery
70h		Display error messages
72h		Check for configuration errors
76h		Check for keyboard errors
7Ch		Set up hardware interrupt vectors
7Eh		Initialize coprocessor if present
80h		Disable onboard Super I/O ports and IRQs
81h		Late POST device initialization

Code	Beeps	POST Routine Description
82h		Detect and install external RS232 ports
83h		Configure non-MCD IDE controllers
84h		Detect and install external parallel ports
85h		Initialize PC-compatible PnP ISA devices
86h		Re-initialize onboard I/O ports
87h		Configure Motherboard Configurable Devices (optional)
88h		Initialize BIOS Area
89h		Enable Non-Maskable Interrupts (NMIs)
8Ah		Initialize Extended BIOS Data Area
8Bh		Test and initialize PS/2 mouse
8Ch		Initialize floppy controller
8Fh		Determine number of ATA drives (optional)
90h		Initialize hard-disk controllers
91h		Initialize local-bus hard-disk controllers
92h		Jump to UserPatch2
93h		Build MPTABLE for multi-processor boards
95h		Install CD ROM for boot
96h		Clear huge ES segment register
97h		Fixup Multi Processor table
98h	1-2	Search for option ROMs. One long, two short beeps on checksum failure.
99h		Check for SMART drive (optional)
9Ah		Shadow option ROMs
9Ch		Set up Power Management
9Dh		Initialize security engine (optional)
9Eh		Enable hardware interrupts
9Fh		Determine number of ATA and SCSI drives
A0h		Set time of day
A2h		Check key lock
A4h		Initialize Typematic rate
A8h		Erase F2 prompt
AAh		Scan for F2 key stroke
ACh		Enter SETUP
A Eh		Clear Boot flag
B0h		Check for errors
B2h		POST done- prepare to boot operating system
B4h	1	One short beep before boot
B5h		Terminate QuietBoot (optional)
B6h		Check password (optional)

Code	Beeps	POST Routine Description
B9h		Prepare Boot
BAh		Initialize DMI parameters
BBh		Initialize PnP Option ROMs
BCh		Clear parity checkers
BDh		Display MultiBoot menu
BEh		Clear screen (optional)
BFh		Check virus and backup reminders
C0h		Try to boot with INT 19
C1h		Initialize POST Error Manager (PEM)
C2h		Initialize error logging
C3h		Initialize error display function
C4h		Initialize system error handler
C5h		PnPnd dual CMOS (optional)
C6h		Initialize notebook docking (optional)
C7h		Initialize notebook docking late
C8h		Force check (optional)
C9h		Extended checksum (optional)
D2h		Unknown interrupt

Code	Beeps	POST Routine Description
E0h		Initialize the chipset
E1h		Initialize the bridge
E2h		Initialize the CPU
E3h		Initialize the system timer
E4h		Initialize system I/O
E5h		Check force recovery boot
E6h		Checksum BIOS ROM
E7h		Go to BIOS
E8h		Set Huge Segment
E9h		Initialize Multi Processor
EAh		Initialize OEM special code
EBh		Initialize PIC and DMA
ECh		Initialize Memory type
EDh		Initialize Memory size
EEh		Shadow Boot Block
EFh		System memory test
F0h		Initialize interrupt vectors
F1h		Initialize Run Time Clock
F2h		Initialize video
F3h		Initialize System Management Mode
F4h	1	Output one beep before boot

Code	Beeps	
F5h		Boot to Mini DOS
F6h		Clear Huge Segment
F7h		Boot to Full DOS

Index of Symptom-to-FRU Error Message

LCD-Related Symptoms

Symptom / Error	Action in Sequence
LCD backlight doesn't work LCD is too dark LCD brightness cannot be adjusted LCD contrast cannot be adjusted	Enter BIOS Utility to execute "Load Setup Default Settings", then reboot system. Reconnect the LCD connectors. Keyboard (if contrast and brightness function key doesn't work). LCD inverter ID LCD cable LCD inverter LCD System board
Unreadable LCD screen Missing pels in characters Abnormal screen Wrong color displayed	Reconnect the LCD connector LCD inverter ID LCD cable LCD inverter LCD System board
LCD has extra horizontal or vertical lines displayed.	LCD inverter ID LCD inverter LCD cable LCD System board

Indicator-Related Symptoms

Symptom / Error	Action in Sequence
Indicator incorrectly remains off or on, but system runs correctly	Reconnect the inverter board Inverter board System board

Power-Related Symptoms

Symptom / Error	Action in Sequence
Power shuts down during operation	Power source (battery pack and power adapter). See "Power System Check" on page 113. Battery pack Power adapter Hard drive & battery connection board System board
The system doesn't power-on.	Power source (battery pack and power adapter). See "Power System Check" on page 113. Battery pack Power adapter Hard drive & battery connection board System board

Power-Related Symptoms

Symptom / Error	Action in Sequence
The system doesn't power-off.	Power source (battery pack and power adapter). See "Power System Check" on page 113. Hold and press the power switch for more than 4 seconds. System board
Battery can't be charged	See "Check the Battery Pack" on page 115. Battery pack System board

PCMCIA-Related Symptoms

Symptom / Error	Action in Sequence
System cannot detect the PC Card (PCMCIA)	PCMCIA slot assembly System board
PCMCIA slot pin is damaged.	PCMCIA slot assembly

Memory-Related Symptoms

Symptom / Error	Action in Sequence
Memory count (size) appears different from actual size.	Enter BIOS Setup Utility to execute "Load Default Settings, then reboot system. DIMM System board

Speaker-Related Symptoms

Symptom / Error	Action in Sequence
In Windows, multimedia programs, no sound comes from the computer.	Audio driver Speaker System board
Internal speakers make noise or emit no sound.	Speaker System board

Power Management-Related Symptoms

Symptom / Error	Action in Sequence
The system will not enter hibernation	See "Save to Disk (S4)" on page 37. Keyboard (if control is from the keyboard) Hard disk drive System board
The system doesn't enter hibernation mode and four short beeps every minute.	Press Fn+0 and see if the computer enters hibernation mode. Touchpad Keyboard Hard disk connection board Hard disk drive System board
The system doesn't enter standby mode after closing the LCD	See "Save to Disk (S4)" on page 37. LCD cover switch System board

Power Management-Related Symptoms

Symptom / Error	Action in Sequence
The system doesn't resume from hibernation mode.	See "Save to Disk (S4)" on page 37. Hard disk connection board Hard disk drive System board
The system doesn't resume from standby mode after opening the LCD.	See "Save to Disk (S4)" on page 37. LCD cover switch System board
Battery fuel gauge in Windows doesn't go higher than 90%.	Remove battery pack and let it cool for 2 hours. Refresh battery (continue use battery until power off, then charge battery). Battery pack System board
System hangs intermittently.	Reconnect hard disk/CD-ROM drives. Hard disk connection board System board

Peripheral-Related Symptoms

Symptom / Error	Action in Sequence
System configuration does not match the installed devices.	Enter BIOS Setup Utility to execute "Load Default Settings", then reboot system. Reconnect hard disk/CD-ROM/diskette drives.
External display does not work correctly.	Press Fn+F5, LCD/CRT/Both display switching System board
USB does not work correctly	System board
Print problems.	Ensure the "Parallel Port" in the "Onboard Devices Configuration" of BIOS Setup Utility is set to Enabled. Onboard Devices Configuration Run printer self-test. Printer driver Printer cable Printer System Board
Serial or parallel port device problems.	Ensure the "Serial Port" in the Devices Configuration" of BIOS Setup Utility is set to Enabled. Device driver Device cable Device System board

Keyboard/Touchpad-Related Symptoms

Symptom / Error	Action in Sequence
Keyboard (one or more keys) does not work.	Reconnect the keyboard cable. Keyboard System board

Keyboard/Touchpad-Related Symptoms

Symptom / Error	Action in Sequence
Touchpad does not work.	Reconnect touchpad cable. Touchpad board System board

Modem-Related Symptoms

Symptom / Error	Action in Sequence
Internal modem does not work correctly.	Modem phone port modem combo board System board

NOTE: If you cannot find a symptom or an error in this list and the problem remains, see “Undetermined Problems” on page 130.

Intermittent Problems

Intermittent system hang problems can be caused by a variety of reasons that have nothing to do with a hardware defect, such as: cosmic radiation, electrostatic discharge, or software errors. FRU replacement should be considered only when a recurring problem exists.

When analyzing an intermittent problem, do the following:

1. Run the advanced diagnostic test for the system board in loop mode at least 10 times.
2. If no error is detected, do not replace any FRU.
3. If any error is detected, replace the FRU. Rerun the test to verify that there are no more errors.

Undetermined Problems

The diagnostic problems does not identify which adapter or device failed, which installed devices are incorrect, whether a short circuit is suspected, or whether the system is inoperative.

Follow these procedures to isolate the failing FRU (do not isolate non-defective FRU).

NOTE: Verify that all attached devices are supported by the computer.

NOTE: Verify that the power supply being used at the time of the failure is operating correctly. (See "Power System Check" on page 113.):

1. Power-off the computer.
2. Visually check them for damage. If any problems are found, replace the FRU.
3. Remove or disconnect all of the following devices:
 - Non-Acer devices
 - Printer, mouse, and other external devices
 - Battery pack
 - Hard disk drive
 - DIMM
 - CD-ROM/Diskette drive Module
 - PC Cards
4. Power-on the computer.
5. Determine if the problem has changed.
6. If the problem does not recur, reconnect the removed devices one at a time until you find the failing FRU.
7. If the problem remains, replace the following FRU one at a time. Do not replace a non-defective FRU:
 - System board
 - LCD assembly

Jumper and Connector Locations

Top and Bottom View

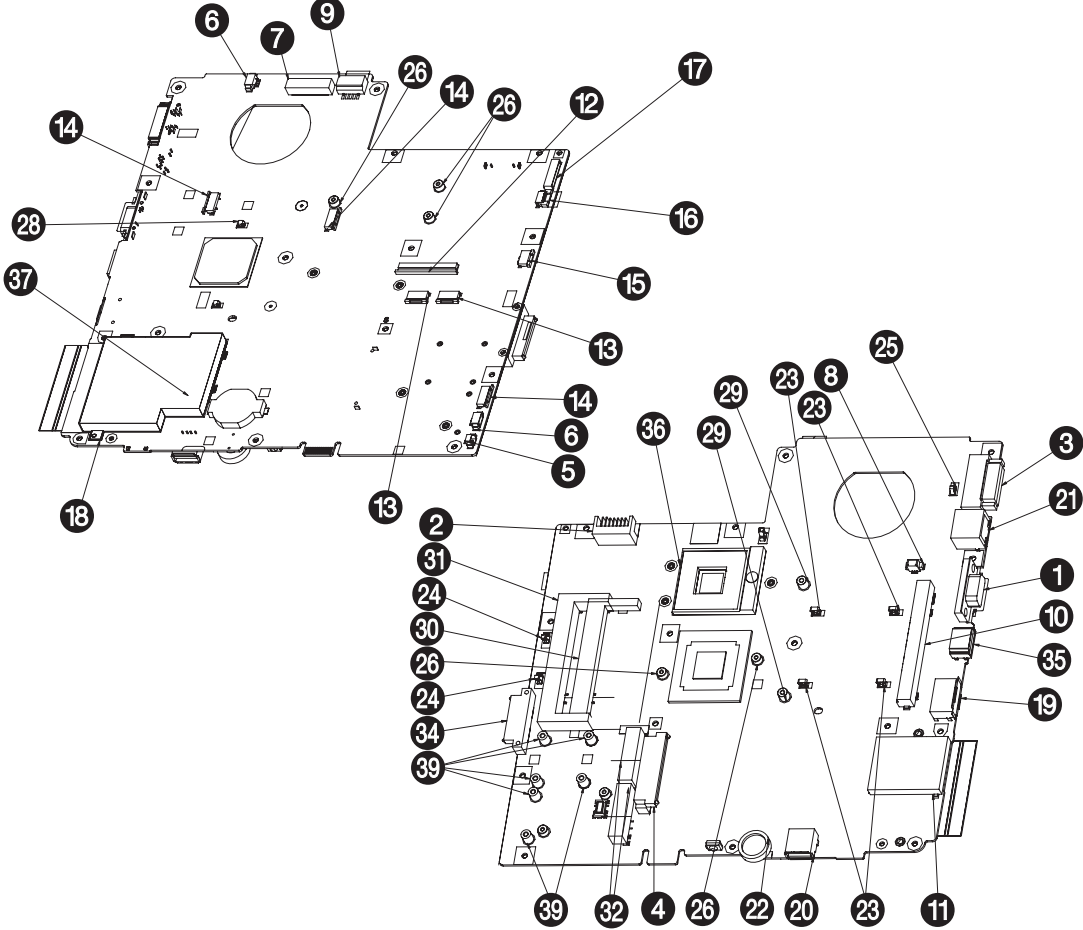

NO	PART NO	DESCRIPTION	QTY	REV	REMARK
1	20.20334.015	TBD	1	0A	
2	20.80701.007	TBD	1	0A	
3	20.80988.001	Dock	1	0A	
4	20.F0754.022	TBD	1	0A	
5	20.F0984.002	TBD	1	0A	
6	20.F0984.004	Speaker,Blue tooth	2	0A	
7	20.F0993.040	LVDS	1	0A	
8	20.F1000.003	TBD	1	0A	
9	20.F1002.005	DC in	1	0A	
10	20.F1031.230	TBD	1	0A	
11	20.I0067.001	TBD	1	0A	
12	20.K0127.026	Keyboard	1	0A	
13	20.K0174.012	TP board,TP button board	2	0A	
14	20.K0227.014	Launch, Audio and Power board	3	0A	
15	20.K0238.008	TBD	1	0A	
16	20.K0265.004	TBD	1	0A	
17	21.D0214.115	TBD	1	0A	
18	21.H0129.001	New card frame	1	0A	
19	22.I0218.581	TBD	1	0A	
20	22.I0218.W51	USB CONN	3	0A	
21	22.I0277.011	RJ45	1	0A	
22	22.70031.001	TBD	1	0A	
23	34.15F09.001	TBD	4	0A	
24	34.40U07.001	EMI	3	0A	
25	34.41Y01.001	EMI	2	0A	
26	34.42Y01.001	DPI.Boss.M20L30	5	1	
27	34.49U26.001	EMI	10	0A	
28	34.4B542.001	EMI spring	3	0A	
29	34.4F405.001	MINI CARD STAND OFF	2	0A	
30	62.10017.691	DDR SODIMM SOCKET	1	0A	
31	62.10017.A71	DDR SO-DIMM	1	0A	
32	62.10043.331	TBD	2	0A	
33	62.10065.181	TBD	1	0A	
34	62.10065.251	TBD	1	0A	
35	62.10078.161	TBD	1	0A	
36	62.10079.001	CPU SOCKET	1	0A	
37	62.10081.011	New Card head	1	0A	
38	TBD	TBD	1	0A	
39	XX.XXXXX.XX1	TBD	6	0A	
40		TBD	4	0A	

Clearing Password Check and BIOS Recovery

This section provide you the standard operating procedures of clearing password and BIOS recovery for Aspire 5930/5930Z/5730Z Series. Aspire 5930/5930Z/5730Z Series provide one Hardware Open Gap on main board for clearing password check, and one Hotkey for enabling BIOS Recovery.

Clearing Password Check

Hardware Open Gap Description

Hardware	Default Setting	Operation Description
Gap	Open (Normal)	Short (Clearing Password Check)

HW Gap position on M/B space:

Gap name in Aspire 5930/5930Z/5730Z Series is G27

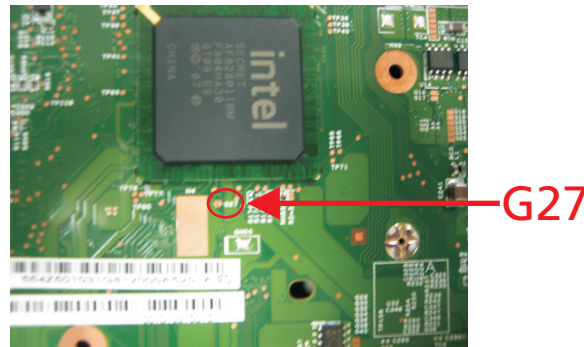

Steps for Clearing BIOS Password Check

If users set BIOS Password (Supervisor Password and/or User Password) for a security reason, BIOS will ask the password during systems POST or when systems enter to BIOS Setup menu. However, once it is necessary to bypass the password check, users need to short the HW Gap to clear the password by the following steps:

- Power Off a system, and remove HDD, AC and Battery from the machine.
- Open the back cover of the machine, and find out the HW Gap on M/B as picture.
- Use an electric conductivity tool to short the two points of the HW Gap.
- Plug in AC, keep the short condition on the HW Gap, and press Power Button to power on the system till BIOS POST finish. Then remove the tool from the HW Gap.
- Restart system. Press F2 key to enter BIOS Setup menu.
- If there is no Password request, BIOS Password is cleared. Otherwise, please follow the steps and try again.

NOTE: The steps are only for clearing BIOS Password (Supervisor Password and User Password).

BIOS Recovery by Crisis Disk

BIOS Recovery Boot Block:

BIOS Recovery Boot Block is a special block of BIOS. It is used to boot up the system with minimum BIOS initialization. Users can enable this feature to restore the BIOS firmware to a successful one once the previous BIOS flashing process failed.

BIOS Recovery Hotkey:

The system provides a function hotkey: **Fn+Esc**, for enable BIOS Recovery process when system is powered on during BIOS POST. To use this function, it is strongly recommended to have the AC adapter and Battery present. If this function is enabled, the system will force the BIOS to enter a special BIOS block, called Boot Block.

Steps for BIOS Recovery by Crisis Disk:

Before doing this, one Crisis Disk should be prepared ready in hand. The Crisis Disk could be made by executing the Crisis Disk program in another system with Windows XP OS.

Follow the steps below:

1. Power Off system.
2. Insert the Crisis Disk to a USB floppy drive which is attached to the BIOS flash failed machine.
3. In the power-off state, press **Fn+Esc** and hold them and then press Power Button. The system should be powered on with Crisis BIOS Recovery process.
4. BIOS Boot Block starts to restore the BIOS code from the Crisis floppy disk to BIOS ROM on the failed machine.
5. If the Crisis flashing process is finished, the system will restart.

If the Crisis Recovery process is finished, the system should be powered on with successful and workable BIOS. Then a person can update the latest version BIOS for this machine by regular BIOS flashing process.

FRU (Field Replaceable Unit) List

This chapter gives you the FRU (Field Replaceable Unit) listing in global configurations of 5930/5930Z/5730Z Series. Refer to this chapter whenever ordering for parts to repair or for RMA (Return Merchandise Authorization).

Please note that WHEN ORDERING FRU PARTS, you should check the most up-to-date information available on your regional web or channel. For whatever reasons a part number change is made, it will not be noted on the printed Service Guide. For ACER AUTHORIZED SERVICE PROVIDERS, your Acer office may have a DIFFERENT part number code from those given in the FRU list of this printed Service Guide. You MUST use the local FRU list provided by your regional Acer office to order FRU parts for repair and service of customer machines.

NOTE: To scrap or to return the defective parts, you should follow the local government ordinance or regulations on how to dispose it properly, or follow the rules set by your regional Acer office on how to return it.

Aspire 5930/5930Z/5730Z Series Exploded Diagram

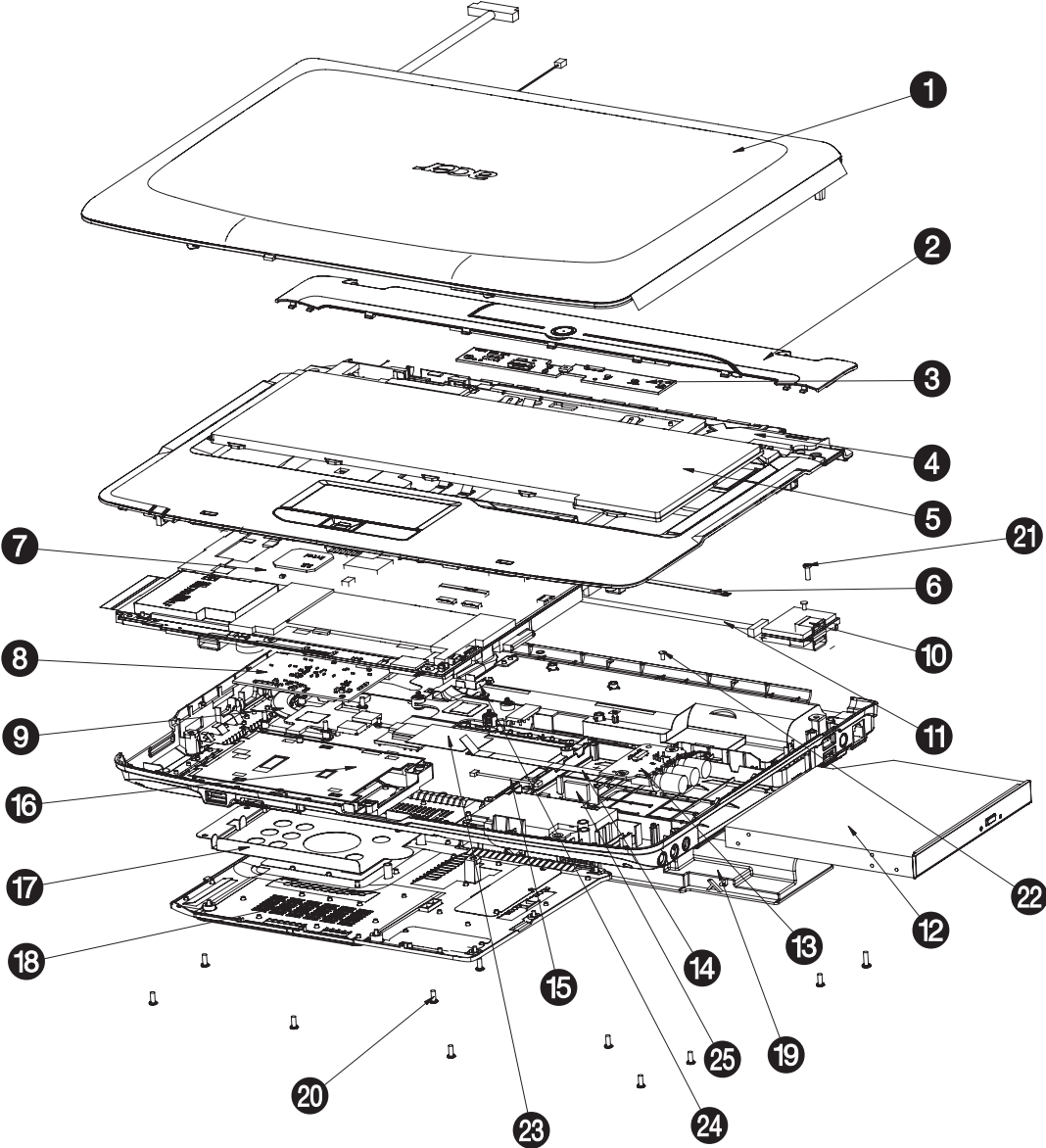



No.	PART No.	DESCRIPTION	Qt'y	Remark
1	65.4Z504.001	ASSY 15.4" LCD EIGER	1	
2	60.4Z502.001	ASSY 60 MIDDLE COVER EIGER	1	
3	55.4Z507.001G	EIGER PD POWER BD	1	
4	65.4Z501.001	ASSY 65 U-CASE W/FP EIGER	1	
5	9J.NIA82.A1D	KB DARFON NSK-AKAID UI US-IN88	1	
6	50.4Z503.101	C.A. MEDIA FFC 2ND EIGER	1	
7	55.xxxxx.001G	EIGER MB	1	mini card tv tuner card
8	54.02A24.021	VGA CARD NB9P-6S/512M GDDR3	1	
9	60.4Z512.001	ASSY HSINK AVC NB9 EIGER	1	
10	55.4Z508.011G	EIGER PD USB BD WITH TV	1	
11	50.4Z511.001	C.A. USB Board EIGER	1	
12	65.4Z5xx.001	EIGER ODD ASSY	1	
13	55.4Z504.011G	EIGER PD AUDIO BD	1	
14	50.4Z515.011	C.A. Audio FFC JH EIGER	1	
15	50.4Z514.001	C.A. Bluetooth EIGER	1	
16	60.4Z503.001	ASSY_L_CASE_EIGER	1	
17	65.4Z506.001	ASSY 65 HDD EIGER	1	
18	60.4Z504.001	ASSY_BIGDOOR_EIGER	1	
19	BT.00807.015	BTY PACK PANA LI+ 8C 2.4AH SMP	1	
20	86.00E12.536	ISO M2.5X6(H=0.7~0.8MM)	11	
21	86.00F84.73A	M2.5*L10 BLACK ZN	2	
22	86.00E13.524	IMS M2X4(H=0.3)	11	
23	34.4Z536.001	EMI FOIL MINICARD EIGER	1	
24	34.4Z534.001	CVR MINI CARD SHIELDING	1	
25	56.25020.005	BT MOD FOXCONN BCM2045 V2	1	

Aspire 5930/5930Z/5730Z Series FRU List

Category	No.	Part Name and Description	Acer Part No.
ACCESSORY			
		REMOTE CONTROLLER FORMOSA21 RC804V-B EN	RT.22700.011
		REMOTE CONTROLLER FORMOSA21 RC804V-B EU	RT.22700.008
Adapter			
		ADAPTER 90W LITEON PA-1900-24AR	AP.09003.011
		ADAPTER 90W DELTA ADP-90SB BBEA LF	AP.09001.013
		ADAPTER 90W 3PIN DELTA ADP-90SB	AP.09001.014
		ADT 90W 19V 3P HP-OL093B13P LF	AP.0900A.001
		ADAPTER 65W 3PIN DELTA SADP-65KB BFJA LF	AP.06501.014
		ADAPTER 65W LITEON PA-1650-02AC LF	AP.06503.016
		ADAPTER 65W HIPRO HP-OK065B13 LF	AP.0650A.010
		ADAPTER 65W DELTA SADP-65KB DFA LF	AP.06501.013
Battery-			
		SANYO AS-2007B LI-ION 3S2P SANYO 6 CELL 4400MAH	BT.00603.042
		SONY AS-2007B LI-ION 3S2P SONY 6 CELL 4400MAH	BT.00604.025
		PANASONIC AS-2007B LI-ION 3S2P PANASONIC 6 CELL 4400MAH	BT.00605.021
		SIMPLO AS-2007B LI-ION 3S2P PANASONIC 6 CELL 4400MAH	BT.00607.016
		SIMPLO AS-2007B LI-ION 4S2P PANASONIC 8 CELL 4800MAH	BT.00807.015
Boards			
		EIGER AUDIO BD 07629-2M (D)	55.AR501.001
		EIGER PD E KEY BD (D)	55.AR501.006
		EIGER PD LAUNCH BD (D)	55.AR501.002
		EIGER PD POWER BD (D)	55.AR501.007
		EIGER PD USB BD WITH TV (D)	55.AQE01.001
		TOUCHPAD SYNAPTICS TM00540-001	56.AGV01.001
		BT MOD FOXCONN BCM2045 V2	BT.21100.005
		WLAN 802.11ABGN SHIRLEYPEAK1*2	KI.SPM01.003
		VGA MXM CARD NVIDIA 9PGSHM DDRIII 512MB W/HDCP (MSI MADE) VGA CARD NB9P-GS/512M GDDR3	55.AQ301.001
		BIWA MINI SENSOR BD 07522-2M	55.TKJ01.001
		EIGER PD FP BD WITH MINI (D)	55.AQ301.002

Category	No.	Part Name and Description	Acer Part No.
		TV TUNCER DVB-T MINI TT-1260DA	TU.23100.015
		CAPACITIVE BUTTON TM-01119-001	55.AR501.005
		MODEM BOARD FOXCONN DELPHI-AM5 V2H 1.5_3.3V	FX.22500.022
Cables			
		LAUNCH BOARD CABLE	50.AR501.002
		MEDIA BOARD CABLE	50.AR501.005
		TOUCHPAD BOARD CABLE	50.AR501.006
		USB BOARD CABLE	50.AR501.003
		BLUETOOTH BOARD CABLE	50.AR501.007
		AUDIO BOARD CABLE	50.AR501.001
		DC-IN CABLE 90W	50.AQ301.001
		TV TUNER BOARD CABLE	50.AQE01.001
		TOUCHPAD BUTTON BOARD CABLE	50.AR501.004
		DC-IN CABLE 65W	50.AR501.008
		LCD/CAMERA CABLE 15.4" WXGA	50.AR501.009
		POWER CORD 10A 125V US	27.T30V1.001
		POWER CORD 10A 125V 3PIN US BK	27.01518.641
		POWER CORD 2.5A 125V 8121- USA/ W CNS	27.01518.781
		POWER CORD 220V 3PIN EUR	27.T30V1.004
		POWER CABLE 16A 250V 3PIN EUR UK	27.01518.731
		POWER CORD 3A 250V 3PIN UK	27.01518.541
		POWER CORD 5A 250V 3PIN UK BK	27.03118.001
		POWER CORD 10A 3PIN BK DENMARK	27.01518.561
		POWER CORD 10A 250V 3PIN DENMARK BK	27.01518.671
		POWER CORD 10A 250V 3PIN BK SOUTH AFRICA	27.01518.571
		POWER CORD 16A 250V SOUTH AFRICA BK	27.01518.681
		POWER CORD 10A 250V SWISS	27.01518.581
		POWER CORD 10A 250V 3PIN SWISS BK	27.01518.691
		POWER CORD 10A 250V 3PIN CHINA	27.01518.591
		POWER CORD 10A 250V 3PIN CHINA BK	27.01518.701
		POWER CORD 10A 250V 3PIN ITALY	27.01518.611
		POWER CORD 10A 250V 3PIN ITALY BK	27.01518.711
		POWER CORD 2.5A 250V SOUTH AFRICA BK (INDIA)	27.01518.631
		POWER CORD 10A 250V SOUTH AFRICA BK (INDIA)	27.01518.721
		POWER CORD 2.5A 250V AUSTRALIA	27.01518.621
		POWER CORD ACA/ACNZ	27.03218.021
		POWER CORD 7A 125V 2PIN JAPEN	27.01518.551
		POWER CORD 7A 125V 2PIN JAPAN	27.03518.161

Category	No.	Part Name and Description	Acer Part No.
		POWER CORD 7A 250V 2PIN KOREA	27.01518.531
		POWER CORD 250V 10A 3PIN ISRAEL	27.01518.761
Case/Cover/Bracket/Assembly			
		LOWER CASE W/MODEM CABLE&FAN BRACKET&SPEAKER FOR TV	60.AQE01.001
		SPEAKER SUB WOFFER	23.AR501.001
		SPEAKER SET	23.AR501.002
		EXPRESS DUMMY CARD	42.AR501.004
		NEW CARD DUMMY CARD	42.TK901.005
		SD DUMMY CARD	42.TK901.006
		MIDDLE COVER	42.AR501.001
		UNITLOAD COVER	42.AR501.002
		E-KEY COVER	42.AR501.003
		TOUCHPAD BRACKET	33.AR501.001
		VGA BOARD BARCKET FOR NVIDIA	33.TPE01.001
		UPPER CASE W/SPEAKER&E KEY CABLE&POWER CABLE&FINGERPRINT HOLE	60.AQ301.002
		OPTICAL BRACKET	33.AR501.002
		BD COMBO BEZEL	42.AR501.005
		SUPER MULIT BEZEL	42.AGV01.005
		HDD BRACKET	33.AR501.003
		LCD COVER 15.4" W/BACKLIGHT MODULE&ANTENNA	60.AR501.005
		LCD BEZEL 15.4" W/MICROPHONE	60.AR501.004
		LCD BRACKET W/HINGE LEFT	33.AR501.004
		LCD BRACKET W/HINGE RIGHT	33.AR501.005
Combo Module			
		COMBO MODULE BLU-RAY 2X	6M.AR501.001
		ODD SONY BD COMBO 12.7MM TRAY DL 2X BC-5500S LF W/O BEZEL SATA	KO.0020E.002
Communication Module			
		EXTERNAL ANTENNA SET	25.AQE01.001
CPU/Processor			

Category	No.	Part Name and Description	Acer Part No.
		CPU INTEL CORE2DUAL P8400 PGA 2.26G 3M 1066 25W	KC.84001.DPP
		CPU INTEL CORE2DUAL P8600 PGA 2.4G 1066 25W 3M	KC.86001.DPP
		CPU INTEL CORE2DUAL P9500 PGA 2.53G 6M 1066 25W	KC.95001.DPP
		CPU INTEL CORE2DUAL T9400 PGA 2.53G 6M 1066 35W	KC.94001.DTP
		CPU INTEL CORE2DUAL T9600 PGA 2.8G 6M 1066 35W	KC.96001.DTP
DVD Module			
		ODD TOSHIBA SUPER-MULTI DRIVE 12.7MM TRAY DL 8X TS-L633A LF W/O BEZEL SATA	KU.00801.021
		ODD PIONEER SUPER-MULTI DRIVE 12.7MM TRAY DL 8X DVR-TD08RS LF W/O BEZEL SATA	KU.00805.044
		ODD PANASONIC SUPER-MULTI DRIVE 12.7MM TRAY DL 8X UJ-870A LF W/O BEZEL SATA	KU.00807.059
		ODD HLDS SUPER-MULTI DRIVE 12.7MM TRAY DL 8X GSA-T50N LF W/ O BEZEL SATA	KU.0080D.029
		ODD HLDS SUPER-MULTI DRIVE 12.7MM TRAY DL 8X GSA-T50N LF W/ O BEZEL SATA MALAYSIA	KU.0080D.034
		ODD SONY SUPER-MULTI DRIVE 12.7MM TRAY DL 8X AD-7560S LF W/O BEZEL SATA	KU.0080E.009
		ODD PLDS SUPER-MULTI DRIVE 12.7MM TRAY DL 8X DS-8A2S LF W/O BEZEL SATA	KU.0080F.001
Fan			
		FAN SUNON	23.AR501.003
Heatsink			
		CPU HEATSINK AVC NB9 W/O FAN	60.AQ301.003
HDD/Hard Disk Drive			

Category	No.	Part Name and Description	Acer Part No.
		HDD 120GB 5400RPM SATA II HGST HTS542512K9SA00 BRONCO-B LF	KH.12007.014
		HDD 120GB 5400RPM SATA SEAGATE ST9120817AS LF	KH.12001.032
		HDD 120GB 5400RPM SATA TOSHIBA MK1246GSX LF	KH.12004.007
		HDD 120GB 5400RPM SATA WD WD1200BEVS-22UST0 ML125 LF	KH.12008.019
		HDD 160GB WD WD1600BEVT-22ZCT0	KH.16008.022
		HDD 160GB 5400RPM SATA II HITACHI HTS541616J9SA00 LF	KH.16007.016
		HDD 160GB SEAGATE SATA ST9160827AS	KH.16001.029
		HDD 160GB 5400RPM SATA TOSHIBA MK1646GSX LF	KH.16004.002
		HDD 250GB SEAGATE SATA ST9250827AS	KH.25001.011
		HDD 250GB 5400RPM SATA TOSHIBA MK2546GSX LF	KH.25004.001
		HDD 250GB 5400RPM SATA II HGST HTS542525K9SA00 LF	KH.25007.011
		HDD 250GB 5400RPM SATA WD WD2500BEVS-22UST0 ML125	KH.25008.018
		HDD 320GB 5400RPM SATA WD WD3200BEVT-22ZCT0 ML125	KH.32008.013
Keyboard			
		KEYBOARD 14_15KB-FV3 BLACK E88KS US INTERNATIONAL (ASPIRE BLACK)	KB.INT00.442
		KEYBOARD 14_15KB-FV3 BLACK E88KS US INTERNATIONAL HEBREW (ASPIRE BLACK)	KB.INT00.443
		KEYBOARD 14_15KB-FV3 BLACK E89KS UK (ASPIRE BLACK)	KB.INT00.444
		KEYBOARD 14_15KB-FV3 BLACK E89KS TURKISH (ASPIRE BLACK)	KB.INT00.445
		KEYBOARD 14_15KB-FV3 BLACK E88KS THAILAND (ASPIRE BLACK)	KB.INT00.446
		KEYBOARD 14_15KB-FV3 BLACK E89KS SWISS/G (ASPIRE BLACK)	KB.INT00.447
		KEYBOARD 14_15KB-FV3 BLACK E89KS SWEDISH (ASPIRE BLACK)	KB.INT00.448
		KEYBOARD 14_15KB-FV3 BLACK E89KS SPANISH (ASPIRE BLACK)	KB.INT00.449
		KEYBOARD 14_15KB-FV3 BLACK 89KS SLO/CRO (ASPIRE BLACK)	KB.INT00.451
		KEYBOARD 14_15KB-FV3 BLACK E88KS RUSSIAN (ASPIRE BLACK)	KB.INT00.452
		KEYBOARD 14_15KB-FV3 BLACK E89KS PORTUGUESE (ASPIRE BLACK)	KB.INT00.453
		KEYBOARD 14_15KB-FV3 BLACK E89KS POLISH (ASPIRE BLACK)	KB.INT00.454

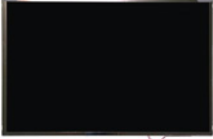
Category	No.	Part Name and Description	Acer Part No.
		KEYBOARD 14_15KB-FV3 BLACK E89KS NORWEGIAN (ASPIRE BLACK)	KB.INT00.455
		KEYBOARD 14_15KB-FV3 BLACK E88KS KOREAN (ASPIRE BLACK)	KB.INT00.457
		KEYBOARD 14_15KB-FV3 BLACK E93KS JAPANESE (ASPIRE BLACK)	KB.INT00.458
		KEYBOARD 14_15KB-FV3 BLACK E89KS ITALIAN (ASPIRE BLACK)	KB.INT00.459
		KEYBOARD 14_15KB-FV3 BLACK E89KS HUNGARIAN (ASPIRE BLACK)	KB.INT00.462
		KEYBOARD 14_15KB-FV3 BLACK E88KS GREEK (ASPIRE BLACK)	KB.INT00.463
		KEYBOARD 14_15KB-FV3 BLACK E89KS GERMAN (ASPIRE BLACK)	KB.INT00.464
		KEYBOARD 14_15KB-FV3 BLACK E89KS FRENCH (ASPIRE BLACK)	KB.INT00.465
		KEYBOARD 14_15KB-FV3 BLACK E89KS DUTCH (ASPIRE BLACK)	KB.INT00.467
		KEYBOARD 14_15KB-FV3 BLACK E89KS DANISH (ASPIRE BLACK)	KB.INT00.468
		KEYBOARD 14_15KB-FV3 BLACK E89KS CZECH (ASPIRE BLACK)	KB.INT00.469
		KEYBOARD 14_15KB-FV3 BLACK E88KS TRADITIONAL CHINESE (ASPIRE BLACK)	KB.INT00.470
		KEYBOARD 14_15KB-FV3 BLACK E89KS CANADIAN FRENCH (ASPIRE BLACK)	KB.INT00.471
		KEYBOARD 14_15KB-FV3 BLACK E89KS BRAZILIAN PORTUGUESE (ASPIRE BLACK)	KB.INT00.472
		KEYBOARD 14_15KB-FV3 BLACK E89KS BELGIUM (ASPIRE BLACK)	KB.INT00.473
		KEYBOARD 14_15KB-FV3 BLACK E88KS ARABIC/ENGLISH (ASPIRE BLACK)	KB.INT00.474
		KEYBOARD 14_15KB-FV3 BLACK E89KS ARABIC/FRENCH (ASPIRE BLACK)	KB.INT00.475
		KEYBOARD 14_15KB-FV3 BLACK E89KS NORDIC (ASPIRE BLACK)	KB.INT00.476
		KEYBOARD 14_15KB-FV3 BLACK E89KS ENGLISH/CANADIAN FRENCH (ASPIRE BLACK)	KB.INT00.477
LCD Module			
		LCD CMO 15.4" WXGA GLARE N154I3-L03 LF 220NIT 8MS	LK.1540D.022
		LCD AUO 15.4" WXGA GLARE B154EW02-V7 W/O BRACKET, H/W CODE 3A LF 220NIT 8MS	LK.15405.028
		LCD AUO 15.4" WXGA GLARE B154EW08-V1 W/O BRACKET, HW 3A LF 220NIT 8MS	LK.15405.029
		LCD LPL 15.4" WXGA GLARE LP154WX4-TLB4 LF 220NIT 8MS	LK.15408.029

Category	No.	Part Name and Description	Acer Part No.
MAINBOARD			
		MAINBOARD AS5930G INTEL LF PGM45 ICH9 LF FOR MONTEVINA CPU WITH PR_ESATA	MB.AQ201.001
		MAINBOARD AS5930 INTEL LF GM45 ICH9 LF FOR MONTEVINA CPU WITH PR_ESATA	MB.AR501.001
MEMORY			
		SODIMM 1GB DDRII667 HYNIX HYMP112S64CP6-Y5 LF	KN.1GB0G.012
		SODIMM 1GB DDRII667 SAMSUNG M470T2864QZ3-CE6	KN.1GB0B.016
		SODIMM 1GB DDRII667 INFINEON HYS64T128021EDL-3S LF	KN.1GB02.036
		SODIMM 1GB DDRII667 NANYA NT1GT64U8HB0BN-3C LF (0.09U)	KN.1GB03.014
		SODIMM 2GB DDRII667 ELPIDA EBE21UE8ACUA-6E-E LF	KN.2GB09.001
		SODIMM 2GB DDRII667 HYNIX HYMP125S64CP8-Y5 LF	KN.2GB0G.004
		SODIMM 2GB DDRII667 SAMSUNG M470T5663QZ3-CE6 LF	KN.2GB0B.003
		SODIMM 2GB DDRII667 MICRON MT16HTF25664HY-667E1 LF	KN.2GB04.001
		SODIMM 512MB DDRII667 HYNIX HYMP164S64CP6-Y5 LF	KN.5120G.024
		SODIMM 512MB DDRII667 NANYA NT512T64UH8B0FN-3C LF	KN.51203.032
		SODIMM 512MB DDRII667 SAMSUNG M470T6464QZ3-CE6 LF	KN.5120B.026
MISCELLANEOUS			
		NAME PLATE AS5930	47.AR501.001
		LOGO PLATE FOR LCD PANEL	47.AR501.002
SCREW			
		IMS M2X4(H=0.3)	86.00E13.524
		SCREW M2*L3 NYLOK CR 3+	86.00E25.723
		SCREW M2-3	86.9A522.3R0
		ISO M2.5X6(H=0.7~0.8MM)	86.00E12.536
		M2.5*L10 BLACK ZN	86.00F84.73A
		SCREW MACH WAFER M3*L4 NI	86.9A524.4R0

Model Definition and Configuration

Aspire 5930/5930Z/5730Z Series

Model	RO	Country	Acer Part no	Description	CPU	LCD	DIMM 1	DIMM 2	HDD 1 (GB)	ODD	Wireless LAN	Bluetooth	VOIP Phone
AS5051ANW XMi	AAP	India	LX.AV30C.002	AS5051AN WXMILINPUSIL1 UMAC 1*512/80/6L/5R/CB_bg_0.3 C_AN	ATMK36	N14.1 WXGAG	SO512 MBI15	N	N80G B5.4K	NSM8 X	ABT_ATH54 13BG	N	N
AS5051ANW XMi	AAP	Indonesia	LX.AV30C.003	AS5051AN WXMILINPUSIN1 UMAC 1*512/80/6L/5R/CB_bg_0.3 C_AN	ATMK36	N14.1 WXGAG	SO512 MBI15	N	N80G B5.4K	NSM8 X	ABT_ATH54 13BG	N	N
AS5051ANW XMi	AAP	Malaysia	LX.AV30C.005	AS5051AN WXMILINPUSMA2 UMAC 1*512/80/6L/5R/CB_bg_0.3 C_AN	ATMK36	N14.1 WXGAG	SO512 MBI15	N	N80G B5.4K	NSM8 X	ABT_ATH54 13BG	N	N
AS5051ANW XMi	AAP	Philippines	LX.AV30C.004	AS5051AN WXMILINPUSPH1 UMAC 1*512/80/6L/5R/CB_bg_0.3 C_AN	ATMK36	N14.1 WXGAG	SO512 MBI15	N	N80G B5.4K	NSM8 X	ABT_ATH54 13BG	N	N
AS5051ANW XMi	AAP	Singapore	LX.AV30C.001	AS5051AN WXMILINPUSSG1 UMAC 1*512/80/6L/5R/CB_bg_0.3 C_AN	ATMK36	N14.1 WXGAG	SO512 MBI15	N	N80G B5.4K	NSM8 X	ABT_ATH54 13BG	N	N
AS5051ANW XMi	AAP	Thailand	LX.AV30C.006	AS5051AN WXMILINPUSTH2 UMAC 1*512/80/6L/5R/CB_bg_0.3 C_AN	ATMK36	N14.1 WXGAG	SO512 MBI15	N	N80G B5.4K	NSM8 X	ABT_ATH54 13BG	N	N
AS5051ANW XMi	AAP	Vietnam	LX.AV30C.007	AS5051AN WXMILINPUSVN1 UMAC 1*512/80/6L/5R/CB_bg_0.3 C_AN	ATMK36	N14.1 WXGAG	SO512 MBI15	N	N80G B5.4K	NSM8 X	ABT_ATH54 13BG	N	N

Model	RO	Country	Acer Part no	Description	CPU	LCD	DIMM 1	DIMM 2	HDD 1 (GB)	ODD	Wireless LAN	Bluetooth	VOIP Phone
AS5051AWX Mi	PA	USA/Canada - Canadian French	LX.AV 30J.001	AS5051AW XMi MCECF UMAC 2*512/120/6L/5R/ CB_bg_0.3 C_AN	ATMK 36	N14.1 WXGA G	SO512 MBII5	SO512 MBII5	N120 GB5.4 K	NSM8 X	ABT_ATH54 13BG	N	N
AS5051AWX Mi	PA	USA/Canada - Canadian French	LX.AV 30J.002	AS5051AW XMi MCEUS UMAC 2*512/120/6L/5R/ CB_bg_0.3 C_AN	ATMK 36	N14.1 WXGA G	SO512 MBII5	SO512 MBII5	N120 GB5.4 K	NSM8 X	ABT_ATH54 13BG	N	N
AS5051AWX Mi	AAP	Australia/New Zealand	LX.AV 305.001	AS5051AW XMi XPHAU1 UMAC 1*512/120/6L/5R/ CB_bg_0.3 C_AN	ATMK 36	N14.1 WXGA G	SO512 MBII5	N	N120 GB5.4 K	NSM8 X	ABT_ATH54 13BG	N	N
AS5051AWX Mi	PA	USA/Canada	LX.AV 305.008	AS5051AW XMi XPHEN1 UMAC 1*512/120/6L/5R/ CB_bg_0.3 C_AN	ATMK 36	N14.1 WXGA G	SO512 MBII5	N	N120 GB5.4 K	NSM8 X	ABT_ATH54 13BG	N	N
AS5051AWX Mi	PA	ACLA-Spanish	LX.AV 305.010	AS5051AW XMi XPHES1 UMAC 1*512/120/6L/5R/ CB_bg_0.3 C_AN	ATMK 36	N14.1 WXGA G	SO512 MBII5	N	N120 GB5.4 K	NSM8 X	ABT_ATH54 13BG	N	N
AS5051AWX Mi	PA	USA/Canada	LX.AV 305.009	AS5051AW XMi XPHFR1 UMAC 1*512/120/6L/5R/ CB_bg_0.3 C_AN	ATMK 36	N14.1 WXGA G	SO512 MBII5	N	N120 GB5.4 K	NSM8 X	ABT_ATH54 13BG	N	N
AS5051AWX Mi	AAP	Indonesia	LX.AV 305.007	AS5051AW XMi XPHIN1 UMAC 1*512/120/6L/5R/ CB_bg_0.3 C_AN	ATMK 36	N14.1 WXGA G	SO512 MBII5	N	N120 GB5.4 K	NSM8 X	ABT_ATH54 13BG	N	N
AS5051AWX Mi	AAP	Malaysia	LX.AV 305.003	AS5051AW XMi XPHMA2 UMAC 1*512/120/6L/5R/ CB_bg_0.3 C_AN	ATMK 36	N14.1 WXGA G	SO512 MBII5	N	N120 GB5.4 K	NSM8 X	ABT_ATH54 13BG	N	N
AS5051AWX Mi	AAP	Philippines	LX.AV 305.002	AS5051AW XMi XPHPH1 UMAC 1*512/120/6L/5R/ CB_bg_0.3 C_AN	ATMK 36	N14.1 WXGA G	SO512 MBII5	N	N120 GB5.4 K	NSM8 X	ABT_ATH54 13BG	N	N

Model	RO	Country	Acer Part no	Description	CPU	LCD	DIMM 1	DIMM 2	HDD 1 (GB)	ODD	Wireless LAN	Bluetooth	VOIP Phone
AS5051AWX Mi	AAP	Thailand	LX.AV 305.004	AS5051AW XMi XPHTH2 UMAC 1*512/120/6L/5R/ CB_bg_0.3 C_AN	ATMK 36	N14.1 WXGAG	SO512 MBII5	N	N120 GB5.4 K	NSM8 X	ABT_ATH54 13BG	N	N
AS5051AWX Mi	AAP	Vietnam	LX.AV 305.005	AS5051AW XMi XPHVN1 UMAC 1*512/120/6L/5R/ CB_bg_0.3 C_AN	ATMK 36	N14.1 WXGAG	SO512 MBII5	N	N120 GB5.4 K	NSM8 X	ABT_ATH54 13BG	N	N
AS5051AWX Mi	AAP	Singapore	LX.AV 305.006	AS5051AW XMi XPHWSG2 1W UMAC 1*512/120/6L/5R/ CB_bg_0.3 C_AN	ATMK 36	N14.1 WXGAG	SO512 MBII5	N	N120 GB5.4 K	NSM8 X	ABT_ATH54 13BG	N	N
AS5051AWX Mi	PA	ACLA-Portuguese	LX.AV 305.011	AS5051AW XMi XPHXC1 UMAC 1*512/120/6L/5R/ CB_bg_0.3 C_AN	ATMK 36	N14.1 WXGAG	SO512 MBII5	N	N120 GB5.4 K	NSM8 X	ABT_ATH54 13BG	N	N
AS5051AWX Mi	TWN	GCTWN	S2.AV 305.001	AS5051AW XMi XPHTC1 UMAC 2*512/120/ BT/6L/5R/ CB_bg_0.3 C_AN	ATMK 36	N14.1 WXGAG	SO512 MBII6	SO512 MBII6	N120 GB5.4 K	NSM8 X	ABT_ATH54 13BG	FOX_BRM_2.0	N
AS5052WXM i	TWN	GCTWN	S2.AV 305.002	AS5052WX Mi XPHTC1 UMAC 2*512/100/ BT/6L/5R/ CB_bg_0.3 C_AN	ATTL5 0	N14.1 WXGAG	SO512 MBII6	SO512 MBII6	N100 GB5.4 K	NSM8 X	ABT_ATH54 13BG	FOX_BRM_2.0	N
AS5055WXM i	TWN	GCTWN	S2.AV 305.003	AS5055WX Mi XPHTC1 UMAC 2*1G/160/ BT/6L/5R/ CB_bg_0.3 C_AN	ATTL6 0	N14.1 WXGAG	SO1G BII5	SO1G BII5	N160 GB5.4 KS	NSM8 X	ABT_BRM4 318BG	FOX_BRM_2.0	N
AS5051AWX Ci	China	Hong Kong	LX.AV 305.016	AS5051AW XCi XPHHK9 UMAC 1*512/120/6L/5R/ CB_bg_0.3 C_AN	ATMK 36	N14.1 WXGAG	SO512 MBII5	N	N120 GB5.4 K	NCB2 4X	ABT_ATH54 13BG	N	N
AS5051AWX Ci	China	China	LX.AV 305.015	AS5051AW XCi XPHSC7 UMAC 1*512/120/6L/5R/ CB_bg_0.3 C_AN	ATMK 36	N14.1 WXGAG	SO512 MBII5	N	N120 GB5.4 K	NCB2 4X	ABT_ATH54 13BG	N	N

Model	RO	Country	Acer Part no	Description	CPU	LCD	DIMM 1	DIMM 2	HDD 1 (GB)	ODD	Wireless LAN	Bluetooth	VOIP Phone
AS5051AWX Mi	TWN	GCTWN	LX.AV 305.01 2	AS5051AW XMi XPHTC1 UMAC 1*512/120/ BT/6L/5R/ CB_bg_0.3 C_AN	ATMK 36	N14.1 WXGA G	SO512 MBII5	N	N120 GB5.4 K	NSM8 X	ABT_ATH54 13BG	FOX_BRM_2.0	N
AS5051AWX Mi	TWN	GCTWN	LX.AV 305.01 4	AS5051AW XMi XPHTC1 UMAC 1*512/60/ BT/6L/5R/ CB_bg_0.3 C_AN	ATMK 36	N14.1 WXGA G	SO512 MBII5	N	N60G B5.4K	NSM8 X	ABT_ATH54 13BG	FOX_BRM_2.0	N
AS5051AWX Mi	TWN	GCTWN	LX.AV 305.01 3	AS5051AW XMi XPHTC1 UMAC 1*512/80/ BT/6L/5R/ CB_bg_0.3 C_AN	ATMK 36	N14.1 WXGA G	SO512 MBII5	N	N80G B5.4K	NSM8 X	ABT_ATH54 13BG	FOX_BRM_2.0	N
AS5051AWX Mi	AAP	Australia/ New Zealand	LX.AV 30J.01 1	AS5051AW XMi MCEAU1 UMAC 1*1G/120/ 6L/5R/ CB_bg_0.3 C_AN	ATMK 36	N14.1 WXGA G	SO1G BII6	N	N120 GB5.4 K	NSM8 X	ABT_ATH54 13BG	N	N
AS5051AWX Mi	AAP	Singapore	LX.AV 30J.01 2	AS5051AW XMi MCESG1 UMAC 1*1G/120/ 6L/5R/ CB_bg_0.3 C_AN	ATMK 36	N14.1 WXGA G	SO1G BII6	N	N120 GB5.4 K	NSM8 X	ABT_ATH54 13BG	N	N
AS5051AWX Mi	AAP	India	LX.AV 30J.01 3	AS5051AW XMi MCEIL1 UMAC 1*1G/120/ 6L/5R/ CB_bg_0.3 C_AN	ATMK 36	N14.1 WXGA G	SO1G BII6	N	N120 GB5.4 K	NSM8 X	ABT_ATH54 13BG	N	N
AS5051AWX Mi	AAP	Indonesia	LX.AV 30J.01 4	AS5051AW XMi MCEIN1 UMAC 1*1G/120/ 6L/5R/ CB_bg_0.3 C_AN	ATMK 36	N14.1 WXGA G	SO1G BII6	N	N120 GB5.4 K	NSM8 X	ABT_ATH54 13BG	N	N
AS5051AWX Mi	AAP	Philippines	LX.AV 30J.01 5	AS5051AW XMi MCEPH1 UMAC 1*1G/120/ 6L/5R/ CB_bg_0.3 C_AN	ATMK 36	N14.1 WXGA G	SO1G BII6	N	N120 GB5.4 K	NSM8 X	ABT_ATH54 13BG	N	N
AS5051AWX Mi	AAP	Malaysia	LX.AV 30J.01 6	AS5051AW XMi MCEMA1 UMAC 1*1G/120/ 6L/5R/ CB_bg_0.3 C_AN	ATMK 36	N14.1 WXGA G	SO1G BII6	N	N120 GB5.4 K	NSM8 X	ABT_ATH54 13BG	N	N

Model	RO	Country	Acer Part no	Description	CPU	LCD	DIMM 1	DIMM 2	HDD 1 (GB)	ODD	Wireless LAN	Bluetooth	VOIP Phone
AS5051AWX Mi	AAP	Thailand	LX.AV 30J.017	AS5051AWXMi MCETH1 UMAC 1*1G/120/ 6L/5R/ CB_bg_0.3 C_AN	ATMK 36	N14.1 WXGAG	SO1G BII6	N	N120 GB5.4 K	NSM8 X	ABT_ATH54 13BG	N	N
AS5051AWX Mi	AAP	Vietnam	LX.AV 30J.018	AS5051AWXMi MCEVN1 UMAC 1*1G/120/ 6L/5R/ CB_bg_0.3 C_AN	ATMK 36	N14.1 WXGAG	SO1G BII6	N	N120 GB5.4 K	NSM8 X	ABT_ATH54 13BG	N	N
AS5051AWX Mi	AAP	Australia/ New Zealand	LX.AV 306.002	AS5051AWXMi XPPAU1 UMAC 1*1G/120/ 6L/5R/ CB_bg_0.3 C_AN	ATMK 36	N14.1 WXGAG	SO1G BII6	N	N120 GB5.4 K	NSM8 X	ABT_ATH54 13BG	N	N
AS5052WXM i	AAP	Australia/ New Zealand	LX.AV 30J.003	AS5052WXM i MCEAU1 UMAC 1*1G/120/ 6L/5R/ CB_bg_0.3 C_AN	ATTL5 0	N14.1 WXGAG	SO1G BII6	N	N120 GB5.4 K	NSM8 X	ABT_ATH54 13BG	N	N
AS5052WXM i	AAP	India	LX.AV 30J.005	AS5052WXM i MCEIL1 UMAC 1*1G/120/ 6L/5R/ CB_bg_0.3 C_AN	ATTL5 0	N14.1 WXGAG	SO1G BII6	N	N120 GB5.4 K	NSM8 X	ABT_ATH54 13BG	N	N
AS5052WXM i	AAP	Indonesia	LX.AV 30J.006	AS5052WXM i MCEIN1 UMAC 1*1G/120/ 6L/5R/ CB_bg_0.3 C_AN	ATTL5 0	N14.1 WXGAG	SO1G BII6	N	N120 GB5.4 K	NSM8 X	ABT_ATH54 13BG	N	N
AS5052WXM i	AAP	Singapore	LX.AV 30J.004	AS5052WXM i MCESG1 UMAC 1*1G/120/ 6L/5R/ CB_bg_0.3 C_AN	ATTL5 0	N14.1 WXGAG	SO1G BII6	N	N120 GB5.4 K	NSM8 X	ABT_ATH54 13BG	N	N
AS5052WXM i	AAP	Philippines	LX.AV 30J.007	AS5052WXM i MCEPH1 UMAC 1*1G/120/ 6L/5R/ CB_bg_0.3 C_AN	ATTL5 0	N14.1 WXGAG	SO1G BII6	N	N120 GB5.4 K	NSM8 X	ABT_ATH54 13BG	N	N
AS5052WXM i	AAP	Malaysia	LX.AV 30J.008	AS5052WXM i MCEMA1 UMAC 1*1G/120/ 6L/5R/ CB_bg_0.3 C_AN	ATTL5 0	N14.1 WXGAG	SO1G BII6	N	N120 GB5.4 K	NSM8 X	ABT_ATH54 13BG	N	N

Model	RO	Country	Acer Part no	Description	CPU	LCD	DIMM 1	DIMM 2	HDD 1 (GB)	ODD	Wireless LAN	Bluetooth	VOIP Phone
AS5052WXM i	AAP	Thailand	LX.AV30J.009	AS5052WXM i MCETH1 UMAC 1*1G/120/ 6L/5R/ CB_bg_0.3 C_AN	ATTL50	N14.1 WXGA G	SO1G BII6	N	N120 GB5.4 K	NSM8 X	ABT_ ATH54 13BG	N	N
AS5052WXM i	AAP	Vietnam	LX.AV30J.010	AS5052WXM i MCEVN1 UMAC 1*1G/120/ 6L/5R/ CB_bg_0.3 C_AN	ATTL50	N14.1 WXGA G	SO1G BII6	N	N120 GB5.4 K	NSM8 X	ABT_ ATH54 13BG	N	N
AS5052WXM i	AAP	Australia/ New Zealand	LX.AV306.001	AS5052WXM i XPPAU1 UMAC 1*1G/120/ 6L/5R/ CB_bg_0.3 C_AN	ATTL50	N14.1 WXGA G	SO1G BII6	N	N120 GB5.4 K	NSM8 X	ABT_ ATH54 13BG	N	N
AS5051ANW XM i	AAP	India	LX.AV30C.015	AS5051ANW XM i LINPUSIL1 UMAC 1*256/60/ 6L/5R/ CB_bg_0.3 C_AN	ATMK36	N14.1 WXGA G	SO256 MBII5	N	N60G B5.4K	NSM8 X	ABT_ ATH54 13BG	N	N
AS5051ANW XM i	AAP	Vietnam	LX.AV30C.014	AS5051ANW XM i LINPUSVN1 UMAC 1*512/60/ 6L/5R/ CB_bg_0.3 C_AN	ATMK36	N14.1 WXGA G	SO512 MBII5	N	N60G B5.4K	NSM8 X	ABT_ ATH54 13BG	N	N
AS5051ANW XM i	AAP	Thailand	LX.AV30C.016	AS5051ANW XM i LINPUSTH2 UMAC 1*512/80/ BT/6L/5R/ CB_bg_0.3 C_AN	ATMK36	N14.1 WXGA G	SO512 MBII5	N	N80G B5.4K	NSM8 X	ABT_ ATH54 13BG	FOX_ BRM_ 2.0	N
AS5051ANW XM i	AAP	Singapore	LX.AV30C.008	AS5051ANW XM i LINPUSSG1 UMAC 1*512/60/ 6L/5R/ CB_bg_0.3 C_AN	ATMK36	N14.1 WXGA G	SO512 MBII5	N	N60G B5.4K	NSM8 X	ABT_ ATH54 13BG	N	N
AS5051ANW XM i	AAP	India	LX.AV30C.009	AS5051ANW XM i LINPUSIL1 UMAC 1*512/60/ 6L/5R/ CB_bg_0.3 C_AN	ATMK36	N14.1 WXGA G	SO512 MBII5	N	N60G B5.4K	NSM8 X	ABT_ ATH54 13BG	N	N
AS5051ANW XM i	AAP	Indonesia	LX.AV30C.010	AS5051ANW XM i LINPUSIN1 UMAC 1*512/60/ 6L/5R/ CB_bg_0.3 C_AN	ATMK36	N14.1 WXGA G	SO512 MBII5	N	N60G B5.4K	NSM8 X	ABT_ ATH54 13BG	N	N

Model	RO	Country	Acer Part no	Description	CPU	LCD	DIMM 1	DIMM 2	HDD 1 (GB)	ODD	Wireless LAN	Bluetooth	VOIP Phone
AS5051ANW XMi	AAP	Philippines	LX.AV 30C.011	AS5051AN WXM i LINPUSPH 1 UMAC 1*512/60/6L/5R/ CB_bg_0.3 C_AN	ATMK 36	N14.1 WXGA G	SO512 MBII5	N	N60G B5.4K	NSM8 X	ABT_ATH54 13BG	N	N
AS5051ANW XMi	AAP	Malaysia	LX.AV 30C.012	AS5051AN WXM i LINPUSMA 2 UMAC 1*512/60/6L/5R/ CB_bg_0.3 C_AN	ATMK 36	N14.1 WXGA G	SO512 MBII5	N	N60G B5.4K	NSM8 X	ABT_ATH54 13BG	N	N
AS5051ANW XMi	AAP	Thailand	LX.AV 30C.013	AS5051AN WXM i LINPUSHT 2 UMAC 1*512/60/6L/5R/ CB_bg_0.3 C_AN	ATMK 36	N14.1 WXGA G	SO512 MBII5	N	N60G B5.4K	NSM8 X	ABT_ATH54 13BG	N	N
AS5052WXM i	AAP	Thailand	LX.AV 30J.019	AS5052WXM i MCETH1 UMAC 1*1G/120/ BT/6L/5R/ CB_bg_0.3 C_AN	ATTL50	N14.1 WXGA G	SO1G BII6	N	N120 GB5.4 K	NSM8 X	ABT_ATH54 13BG	FOX_BRM_2.0	N
AS5051AWX Mi	EMEA	Belgium	LX.AV 30J.032	AS5051AW XMi MCEBE6 UMAC 2*512/100/6L/5R_bg_0.3 C_AN	ATMK 36	N14.1 WXGA	SO512 MBII6	SO512 MBII6	N100 GB5.4 K	NSM8 X	ABT_BRM4 318BG	N	N
AS5051AWX Mi	EMEA	Middle East	LX.AV 30J.043	AS5051AW XMi MCEAR1 UMAC 2*512/100/6L/5R_bg_0.3 C_AN	ATMK 36	N14.1 WXGA	SO512 MBII6	SO512 MBII6	N100 GB5.4 K	NSM8 X	ABT_BRM4 318BG	N	N
AS5051AWX Mi	EMEA	Middle East	LX.AV 30J.044	AS5051AW XMi MCEAR2 UMAC 2*512/100/6L/5R_bg_0.3 C_AN	ATMK 36	N14.1 WXGA	SO512 MBII6	SO512 MBII6	N100 GB5.4 K	NSM8 X	ABT_BRM4 318BG	N	N
AS5051AWX Mi	EMEA	Italy	LX.AV 30J.040	AS5051AW XMi MCEIT7 UMAC 2*512/100/6L/5R_bg_0.3 C_AN	ATMK 36	N14.1 WXGA	SO512 MBII6	SO512 MBII6	N100 GB5.4 K	NSM8 X	ABT_BRM4 318BG	N	N
AS5051AWX Mi	EMEA	Spain	LX.AV 30J.039	AS5051AW XMi MCEESJ UMAC 2*512/100/6L/5R_bg_0.3 C_AN	ATMK 36	N14.1 WXGA	SO512 MBII6	SO512 MBII6	N100 GB5.4 K	NSM8 X	ABT_BRM4 318BG	N	N

Model	RO	Country	Acer Part no	Description	CPU	LCD	DIMM 1	DIMM 2	HDD 1 (GB)	ODD	Wireless LAN	Bluetooth	VOIP Phone
AS5051AWX Mi	EMEA	Eastern Europe	LX.AV 30J.030	AS5051AWXMi MCECS5 UMAC 2*512/100/6L/ 5R_bg_0.3 C_AN	ATMK 36	N14.1 WXGA	SO512 MBII6	SO512 MBII6	N100 GB5.4 K	NSM8 X	ABT_BRM4 318BG	N	N
AS5051AWX Mi	EMEA	Denmark	LX.AV 30J.024	AS5051AWXMi MCEDK6 UMAC 2*512/100/6L/ 5R_bg_0.3 C_AN	ATMK 36	N14.1 WXGA	SO512 MBII6	SO512 MBII6	N100 GB5.4 K	NSM8 X	ABT_BRM4 318BG	N	N
AS5051AWX Mi	EMEA	France	LX.AV 30J.025	AS5051AWXMi MCEFRF UMAC 2*512/100/6L/ 5R_bg_0.3 C_AN	ATMK 36	N14.1 WXGA	SO512 MBII6	SO512 MBII6	N100 GB5.4 K	NSM8 X	ABT_BRM4 318BG	N	N
AS5051AWX Mi	EMEA	Germany	LX.AV 30J.027	AS5051AWXMi MCEDEA UMAC 2*512/100/6L/ 5R_bg_0.3 C_AN	ATMK 36	N14.1 WXGA	SO512 MBII6	SO512 MBII6	N100 GB5.4 K	NSM8 X	ABT_BRM4 318BG	N	N
AS5051AWX Mi	EMEA	Germany	LX.AV 30J.028	AS5051AWXMi MCEDEB UMAC 2*512/100/6L/ 5R_bg_0.3 C_AN	ATMK 36	N14.1 WXGA	SO512 MBII6	SO512 MBII6	N100 GB5.4 K	NSM8 X	ABT_BRM4 318BG	N	N
AS5051AWX Mi	EMEA	Holland	LX.AV 30J.033	AS5051AWXMi MCENL6 UMAC 2*512/100/6L/ 5R_bg_0.3 C_AN	ATMK 36	N14.1 WXGA	SO512 MBII6	SO512 MBII6	N100 GB5.4 K	NSM8 X	ABT_BRM4 318BG	N	N
AS5051AWX Mi	EMEA	Norway	LX.AV 30J.034	AS5051AWXMi MCENO5 UMAC 2*512/100/6L/ 5R_bg_0.3 C_AN	ATMK 36	N14.1 WXGA	SO512 MBII6	SO512 MBII6	N100 GB5.4 K	NSM8 X	ABT_BRM4 318BG	N	N
AS5051AWX Mi	EMEA	Russia	LX.AV 30J.035	AS5051AWXMi MCERU9 UMAC 2*512/100/6L/ 5R_bg_0.3 C_AN	ATMK 36	N14.1 WXGA	SO512 MBII6	SO512 MBII6	N100 GB5.4 K	NSM8 X	ABT_BRM4 318BG	N	N
AS5051AWX Mi	EMEA	Eastern Europe	LX.AV 30J.036	AS5051AWXMi MCEPL7 UMAC 2*512/100/6L/ 5R_bg_0.3 C_AN	ATMK 36	N14.1 WXGA	SO512 MBII6	SO512 MBII6	N100 GB5.4 K	NSM8 X	ABT_BRM4 318BG	N	N

Model	RO	Country	Acer Part no	Description	CPU	LCD	DIMM 1	DIMM 2	HDD 1 (GB)	ODD	Wireless LAN	Bluetooth	VOIP Phone
AS5051AWX Mi	EMEA	Slovenia/Croatia	LX.AV 30J.037	AS5051AW XMi MCE511 UMAC 2*512/100/6L/ 5R_bg_0.3 C_AN	ATMK 36	N14.1 WXGA	SO512 MBII6	SO512 MBII6	N100 GB5.4 K	NSM8 X	ABT_BRM4 318BG	N	N
AS5051AWX Mi	EMEA	Portugal	LX.AV 30J.038	AS5051AW XMi MCEPT6 UMAC 2*512/100/6L/ 5R_bg_0.3 C_AN	ATMK 36	N14.1 WXGA	SO512 MBII6	SO512 MBII6	N100 GB5.4 K	NSM8 X	ABT_BRM4 318BG	N	N
AS5051AWX Mi	EMEA	Sweden/Finland	LX.AV 30J.029	AS5051AW XMi MCE5V5 UMAC 2*512/100/6L/ 5R_bg_0.3 C_AN	ATMK 36	N14.1 WXGA	SO512 MBII6	SO512 MBII6	N100 GB5.4 K	NSM8 X	ABT_BRM4 318BG	N	N
AS5051AWX Mi	EMEA	Turkey	LX.AV 30J.041	AS5051AW XMi MCETR5 UMAC 2*512/100/6L/ 5R_bg_0.3 C_AN	ATMK 36	N14.1 WXGA	SO512 MBII6	SO512 MBII6	N100 GB5.4 K	NSM8 X	ABT_BRM4 318BG	N	N
AS5051AWX Mi	EMEA	Switzerland	LX.AV 30J.045	AS5051AW XMi MCE5W8 UMAC 2*512/100/6L/ 5R_bg_0.3 C_AN	ATMK 36	N14.1 WXGA	SO512 MBII6	SO512 MBII6	N100 GB5.4 K	NSM8 X	ABT_BRM4 318BG	N	N
AS5051AWX Mi	EMEA	UK	LX.AV 30J.046	AS5051AW XMi MCEUK5 UMAC 2*512/100/6L/ 5R_bg_0.3 C_AN	ATMK 36	N14.1 WXGA	SO512 MBII6	SO512 MBII6	N100 GB5.4 K	NSM8 X	ABT_BRM4 318BG	N	N
AS5051AWX Mi	EMEA	UK	LX.AV 30J.047	AS5051AW XMi MCEWUK1 1W UMAC 2*512/100/6L/ 5R_bg_0.3 C_AN	ATMK 36	N14.1 WXGA	SO512 MBII6	SO512 MBII6	N100 GB5.4 K	NSM8 X	ABT_BRM4 318BG	N	N
AS5051AWX Mi	EMEA	Italy	LX.AV 30J.042	AS5051AW XMi MCEWIT11 W UMAC 2*512/100/6L/ 5R_bg_0.3 C_AN	ATMK 36	N14.1 WXGA	SO512 MBII6	SO512 MBII6	N100 GB5.4 K	NSM8 X	ABT_BRM4 318BG	N	N
AS5051AWX Mi	EMEA	Germany	LX.AV 30J.031	AS5051AW XMi MCEWDE1 1W UMAC 2*512/100/6L/ 5R_bg_0.3 C_AN	ATMK 36	N14.1 WXGA	SO512 MBII6	SO512 MBII6	N100 GB5.4 K	NSM8 X	ABT_BRM4 318BG	N	N

Model	RO	Country	Acer Part no	Description	CPU	LCD	DIMM 1	DIMM 2	HDD 1 (GB)	ODD	Wireless LAN	Bluetooth	VOIP Phone
AS5051AWX Mi	EMEA	France	LX.AV 30J.026	AS5051AW XMi MCEWFR1 1W UMAC 2*512/100/6L/ 5R_bg_0.3 C_AN	ATMK 36	N14.1 WXGA	SO512 MBII6	SO512 MBII6	N100 GB5.4 K	NSM8 X	ABT_BRM4 318BG	N	N
AS5051AWX Mi	EMEA	Belgium	LX.AV 305.019	AS5051AW XMi XPHBE1 UMAC 2*512/100/6L/ 5R_bg_0.3 C_AN	ATMK 36	N14.1 WXGA	SO512 MBII6	SO512 MBII6	N100 GB5.4 K	NSM8 X	ABT_BRM4 318BG	N	N
AS5051AWX Mi	EMEA	Middle East	LX.AV 305.038	AS5051AW XMi XPHAR1 UMAC 2*512/100/6L/ 5R_bg_0.3 C_AN	ATMK 36	N14.1 WXGA	SO512 MBII6	SO512 MBII6	N100 GB5.4 K	NSM8 X	ABT_BRM4 318BG	N	N
AS5051AWX Mi	EMEA	Eastern Europe	LX.AV 305.027	AS5051AW XMi XPHCS2 UMAC 2*512/100/6L/ 5R_bg_0.3 C_AN	ATMK 36	N14.1 WXGA	SO512 MBII6	SO512 MBII6	N100 GB5.4 K	NSM8 X	ABT_BRM4 318BG	N	N
AS5051AWX Mi	EMEA	Germany	LX.AV 305.023	AS5051AW XMi XPHDE7 UMAC 2*512/100/6L/ 5R_bg_0.3 C_AN	ATMK 36	N14.1 WXGA	SO512 MBII6	SO512 MBII6	N100 GB5.4 K	NSM8 X	ABT_BRM4 318BG	N	N
AS5051AWX Mi	EMEA	Greece	LX.AV 305.033	AS5051AW XMi XPHL1 UMAC 2*512/100/6L/ 5R_bg_0.3 C_AN	ATMK 36	N14.1 WXGA	SO512 MBII6	SO512 MBII6	N100 GB5.4 K	NSM8 X	ABT_BRM4 318BG	N	N
AS5051AWX Mi	EMEA	Israel	LX.AV 305.034	AS5051AW XMi XPHIS1 UMAC 2*512/100/6L/ 5R_bg_0.3 C_AN	ATMK 36	N14.1 WXGA	SO512 MBII6	SO512 MBII6	N100 GB5.4 K	NSM8 X	ABT_BRM4 318BG	N	N
AS5051AWX Mi	EMEA	Italy	LX.AV 305.035	AS5051AW XMi XPHIT1 UMAC 2*512/100/6L/ 5R_bg_0.3 C_AN	ATMK 36	N14.1 WXGA	SO512 MBII6	SO512 MBII6	N100 GB5.4 K	NSM8 X	ABT_BRM4 318BG	N	N
AS5051AWX Mi	EMEA	Denmark	LX.AV 305.018	AS5051AW XMi XPHDK1 UMAC 2*512/100/6L/ 5R_bg_0.3 C_AN	ATMK 36	N14.1 WXGA	SO512 MBII6	SO512 MBII6	N100 GB5.4 K	NSM8 X	ABT_BRM4 318BG	N	N

Model	RO	Country	Acer Part no	Description	CPU	LCD	DIMM 1	DIMM 2	HDD 1 (GB)	ODD	Wireless LAN	Bluetooth	VOIP Phone
AS5051AWX Mi	EMEA	Holland	LX.AV 305.020	AS5051AWXMi XPHNL1 UMAC 2*512/100/6L/ 5R_bg_0.3 C_AN	ATMK 36	N14.1 WXGA	SO512 MBII6	SO512 MBII6	N100 GB5.4 K	NSM8 X	ABT_BRM4 318BG	N	N
AS5051AWX Mi	EMEA	France	LX.AV 305.021	AS5051AWXMi XPHFRA UMAC 2*512/100/6L/ 5R_bg_0.3 C_AN	ATMK 36	N14.1 WXGA	SO512 MBII6	SO512 MBII6	N100 GB5.4 K	NSM8 X	ABT_BRM4 318BG	N	N
AS5051AWX Mi	EMEA	Eastern Europe	LX.AV 305.028	AS5051AWXMi XPHHU6 UMAC 2*512/100/6L/ 5R_bg_0.3 C_AN	ATMK 36	N14.1 WXGA	SO512 MBII6	SO512 MBII6	N100 GB5.4 K	NSM8 X	ABT_BRM4 318BG	N	N
AS5051AWX Mi	EMEA	Spain	LX.AV 305.031	AS5051AWXMi XPHESA UMAC 2*512/100/6L/ 5R_bg_0.3 C_AN	ATMK 36	N14.1 WXGA	SO512 MBII6	SO512 MBII6	N100 GB5.4 K	NSM8 X	ABT_BRM4 318BG	N	N
AS5051AWX Mi	EMEA	Slovenia/Croatia	LX.AV 305.030	AS5051AWXMi XPHSLO2 UMAC 2*512/100/6L/ 5R_bg_0.3 C_AN	ATMK 36	N14.1 WXGA	SO512 MBII6	SO512 MBII6	N100 GB5.4 K	NSM8 X	ABT_BRM4 318BG	N	N
AS5051AWX Mi	EMEA	Eastern Europe	LX.AV 305.029	AS5051AWXMi XPHPL6 UMAC 2*512/100/6L/ 5R_bg_0.3 C_AN	ATMK 36	N14.1 WXGA	SO512 MBII6	SO512 MBII6	N100 GB5.4 K	NSM8 X	ABT_BRM4 318BG	N	N
AS5051AWX Mi	EMEA	Portugal	LX.AV 305.032	AS5051AWXMi XPHPT1 UMAC 2*512/100/6L/ 5R_bg_0.3 C_AN	ATMK 36	N14.1 WXGA	SO512 MBII6	SO512 MBII6	N100 GB5.4 K	NSM8 X	ABT_BRM4 318BG	N	N
AS5051AWX Mi	EMEA	Switzerland	LX.AV 305.039	AS5051AWXMi XPHSW5 UMAC 2*512/100/6L/ 5R_bg_0.3 C_AN	ATMK 36	N14.1 WXGA	SO512 MBII6	SO512 MBII6	N100 GB5.4 K	NSM8 X	ABT_BRM4 318BG	N	N
AS5051AWX Mi	EMEA	Turkey	LX.AV 305.036	AS5051AWXMi XPHTR1 UMAC 2*512/100/6L/ 5R_bg_0.3 C_AN	ATMK 36	N14.1 WXGA	SO512 MBII6	SO512 MBII6	N100 GB5.4 K	NSM8 X	ABT_BRM4 318BG	N	N

Model	RO	Country	Acer Part no	Description	CPU	LCD	DIMM 1	DIMM 2	HDD 1 (GB)	ODD	Wireless LAN	Bluetooth	VOIP Phone
AS5051AWX Mi	EMEA	South Africa	LX.AV 305.017	AS5051AW XMi XPHSA1 UMAC 2*512/100/6L/ 5R_bg_0.3 C_AN	ATMK 36	N14.1 WXGA	SO512 MBII6	SO512 MBII6	N100 GB5.4 K	NSM8 X	ABT_BRM4 318BG	N	N
AS5051AWX Mi	EMEA	Norway	LX.AV 305.024	AS5051AW XMi XPHNO1 UMAC 2*512/100/6L/ 5R_bg_0.3 C_AN	ATMK 36	N14.1 WXGA	SO512 MBII6	SO512 MBII6	N100 GB5.4 K	NSM8 X	ABT_BRM4 318BG	N	N
AS5051AWX Mi	EMEA	Russia	LX.AV 305.025	AS5051AW XMi XPHRU2 UMAC 2*512/100/6L/ 5R_bg_0.3 C_AN	ATMK 36	N14.1 WXGA	SO512 MBII6	SO512 MBII6	N100 GB5.4 K	NSM8 X	ABT_BRM4 318BG	N	N
AS5051AWX Mi	EMEA	Sweden/ Finland	LX.AV 305.026	AS5051AW XMi XPHSV1 UMAC 2*512/100/6L/ 5R_bg_0.3 C_AN	ATMK 36	N14.1 WXGA	SO512 MBII6	SO512 MBII6	N100 GB5.4 K	NSM8 X	ABT_BRM4 318BG	N	N
AS5051AWX Mi	EMEA	France	LX.AV 305.022	AS5051AW XMi XPHWFRB 1W UMAC 2*512/100/6L/ 5R_bg_0.3 C_AN	ATMK 36	N14.1 WXGA	SO512 MBII6	SO512 MBII6	N100 GB5.4 K	NSM8 X	ABT_BRM4 318BG	N	N
AS5051AWX Mi	EMEA	Italy	LX.AV 305.037	AS5051AW XMi XPHWIT21 W UMAC 2*512/100/6L/ 5R_bg_0.3 C_AN	ATMK 36	N14.1 WXGA	SO512 MBII6	SO512 MBII6	N100 GB5.4 K	NSM8 X	ABT_BRM4 318BG	N	N
AS5051AWX Mi	EMEA	UK	LX.AV 305.040	AS5051AW XMi XPHUK1 UMAC 2*512/100/6L/ 5R_bg_0.3 C_AN	ATMK 36	N14.1 WXGA	SO512 MBII6	SO512 MBII6	N100 GB5.4 K	NSM8 X	ABT_BRM4 318BG	N	N
AS5051AWX Mi	EMEA	UK	LX.AV 305.041	AS5051AW XMi XPHWUK2 1W UMAC 2*512/100/6L/ 5R_bg_0.3 C_AN	ATMK 36	N14.1 WXGA	SO512 MBII6	SO512 MBII6	N100 GB5.4 K	NSM8 X	ABT_BRM4 318BG	N	N
AS5052WXM i	PA	USA/ Canada - Canadian French	LX.AV 30J.020	AS5052WXM i MCECF UMAC 2*512/120/6L/5R/ CB_bg_0.3 C_AN	ATTL5 0	N14.1 WXGA G	SO512 MBII5	SO512 MBII5	N120 GB5.4 K	NSM8 X	ABT_ATH54 13BG	N	N

Model	RO	Country	Acer Part no	Description	CPU	LCD	DIMM 1	DIMM 2	HDD 1 (GB)	ODD	Wireless LAN	Bluetooth	VOIP Phone
AS505 2WXM i	PA	USA/ Canada - Canadian French	LX.AV 30J.02 1	AS5052WX Mi MCEUS UMAC 2*512/120/ 6L/5R/ CB_bg_0.3 C_AN	ATTL5 0	N14.1 WXGA G	SO512 MBII5	SO512 MBII5	N120 GB5.4 K	NSM8 X	ABT_ATH54 13BG	N	N
AS505 2WXM i	PA	ACLA-Spanish	LX.AV 30J.02 2	AS5052WX Mi MCEES1 UMAC 2*512/120/ 6L/5R/ CB_bg_0.3 C_AN	ATTL5 0	N14.1 WXGA G	SO512 MBII5	SO512 MBII5	N120 GB5.4 K	NSM8 X	ABT_ATH54 13BG	N	N
AS505 1AWX Mi	PA	ACLA-Spanish	LX.AV 30J.04 8	AS5051AW XMi MCEES1 UMAC 2*512/120/ 6L/5R/ CB_bg_0.3 C_AN	ATMK 36	N14.1 WXGA G	SO512 MBII5	SO512 MBII5	N120 GB5.4 K	NSM8 X	ABT_BRM4 318BG	N	N
AS505 1ANW XCi	AAP	Australia/ New Zealand	LX.AV 30C.0 17	AS5051AN WXCi LINPUSAU 1 UMAC 1*512/80/ 6L/5R/ CB_bg_0.3 C_AN	ATMK 36	N14.1 WXGA G	SO512 MBII5	N	N80G B5.4K	NCB2 4X	ABT_BRM4 318BG	N	N
AS505 1AWX Ci	AAP	Malaysia	LX.AV 305.04 2	AS5051AW XCi XPHMA2 UMAC 1*512/80/ 6L/5R/ CB_bg_0.3 C_AN	ATMK 36	N14.1 WXGA G	SO512 MBII5	N	N80G B5.4K	NCB2 4X	ABT_BRM4 318BG	N	N
AS505 1ANW XCi	AAP	Malaysia	LX.AV 30C.0 18	AS5051AN WXCi LINPUSMA 2 UMAC 1*512/80/ 6L/5R/ CB_bg_0.3 C_AN	ATMK 36	N14.1 WXGA G	SO512 MBII5	N	N80G B5.4K	NCB2 4X	ABT_BRM4 318BG	N	N
AS505 1AWX Mi	EMEA	Sweden/ Finland	LX.AV 30J.04 9	AS5051AW XMi MCESV5 UMAC 1*512/100/ BT/6L/5R/ CB_bg_VP _0.3C_AN	ATMK 36	N14.1 WXGA G	SO512 MBII6	N	N100 GB5.4 K	NSM8 X	ABT_BRM4 318BG	FOX_BRM_ 2.0	BT VoIP PCMC IA
AS505 1AWX Mi	EMEA	Slovenia/ Croatia	LX.AV 30J.05 0	AS5051AW XMi MCES1 UMAC 1*512/100/ BT/6L/5R/ CB_bg_VP _0.3C_AN	ATMK 36	N14.1 WXGA G	SO512 MBII6	N	N100 GB5.4 K	NSM8 X	ABT_BRM4 318BG	FOX_BRM_ 2.0	BT VoIP PCMC IA
AS505 1AWX Mi	EMEA	Holland	LX.AV 30J.05 1	AS5051AW XMi MCENL6 UMAC 1*512/100/ BT/6L/5R/ CB_bg_VP _0.3C_AN	ATMK 36	N14.1 WXGA G	SO512 MBII6	N	N100 GB5.4 K	NSM8 X	ABT_BRM4 318BG	FOX_BRM_ 2.0	BT VoIP PCMC IA

Model	RO	Country	Acer Part no	Description	CPU	LCD	DIMM 1	DIMM 2	HDD 1 (GB)	ODD	Wireless LAN	Bluetooth	VOIP Phone
AS5051AWX Mi	EMEA	Russia	LX.AV 30J.05 2	AS5051AW XMi MCERU9 UMAC 1*512/100/ BT/6L/5R/ CB_bg_VP_0.3C_AN	ATMK 36	N14.1 WXGA G	SO512 MBII6	N	N100 GB5.4 K	NSM8 X	ABT_BRM4 318BG	FOX_BRM_2.0	BT VoIP PCMC IA
AS5051AWX Mi	EMEA	Holland	LX.AV 30J.05 4	AS5051AW XMi MCENL6 UMAC 1*512/100/ BT/6L/ 5R_bg_VP_0.3C_AN	ATMK 36	N14.1 WXGA	SO512 MBII6	N	N100 GB5.4 K	NSM8 X	ABT_BRM4 318BG	FOX_BRM_2.0	BT VoIP PCMC IA
AS5051AWX Mi	EMEA	Russia	LX.AV 305.04 3	AS5051AW XMi XPHRU2 UMAC 1*512/100/ 6L/ 5R_bg_0.3 C_AN	ATMK 36	N14.1 WXGA	SO512 MBII6	N	N100 GB5.4 K	NSM8 X	ABT_BRM4 318BG	N	N
AS5051AWX Mi	EMEA	Sweden/ Finland	LX.AV 30J.05 5	AS5051AW XMi MCESV5 UMAC 1*512/100/ BT/6L/ 5R_bg_VP_0.3C_AN	ATMK 36	N14.1 WXGA	SO512 MBII6	N	N100 GB5.4 K	NSM8 X	ABT_BRM4 318BG	FOX_BRM_2.0	BT VoIP PCMC IA
AS5051AWX Mi	EMEA	Slovenia/ Croatia	LX.AV 30J.05 3	AS5051AW XMi MCESI1 UMAC 1*512/100/ BT/6L/ 5R_bg_VP_0.3C_AN	ATMK 36	N14.1 WXGA	SO512 MBII6	N	N100 GB5.4 K	NSM8 X	ABT_BRM4 318BG	FOX_BRM_2.0	BT VoIP PCMC IA
AS5052NWX Mi	AAP	Thailand	LX.AV 30C.0 19	AS5052N WXM Mi LINPUSH 2 UMAC 1*512/120/ BT/6L/5R/ CB_bg_0.3 C_AN	ATTL5 0	N14.1 WXGA G	SO512 MBII5	N	N120 GB5.4 K	NSM8 X	ABT_BRM4 318BG	FOX_BRM_2.0	N
AS5053WXM i	AAP	Thailand	LX.AV 30J.05 6	AS5053WXM i MCETH1 UMAC 1*1G/120/ BT/6L/5R/ CB_bg_0.3 C_AN	ATTL5 2	N14.1 WXGA G	SO1G BII6	N	N120 GB5.4 K	NSM8 X	ABT_BRM4 318BG	FOX_BRM_2.0	N
AS5051ANW XMi	EMEA	Middle East	LX.AV 30C.0 22	AS5051AN WXM i LINPUSAR 9 UMAC 1*512/60/ BT/6L/ 5R_bg_0.3 C_AN	ATMK 36	N14.1 WXGA	SO512 MBII5	N	N60G B5.4K	NSM8 X	ABT_BRM4 318BG	FOX_BRM_2.0	N
AS5051ANW XMi	EMEA	Middle East	LX.AV 30C.0 24	AS5051AN WXM i LINPUSAR 9 UMAC 1*512/60/ BT/6L/5R/ CB_bg_0.3 C_AN	ATMK 36	N14.1 WXGA G	SO512 MBII5	N	N60G B5.4K	NSM8 X	ABT_BRM4 318BG	FOX_BRM_2.0	N

Model	RO	Country	Acer Part no	Description	CPU	LCD	DIMM 1	DIMM 2	HDD 1 (GB)	ODD	Wireless LAN	Bluetooth	VOIP Phone
AS5051ANW XMi	EMEA	Middle East	LX.AV 30C.0 20	AS5051AN WXMi LINPUSAR 7 UMAC 1*512/60/ BT/6L/ 5R_bg_0.3 C_AN	ATMK 36	N14.1 WXGA	SO512 MBII5	N	N60G B5.4K	NSM8 X	ABT_ BRM4 318BG	FOX_ BRM_ 2.0	N
AS5051ANW XMi	EMEA	France	LX.AV 30C.0 21	AS5051AN WXMi LINPUSFR A UMAC 1*512/60/ 6L/ 5R_bg_0.3 C_AN	ATMK 36	N14.1 WXGA	SO512 MBII5	N	N60G B5.4K	NSM8 X	ABT_ BRM4 318BG	N	N
AS5051ANW XMi	EMEA	Russia	LX.AV 30C.0 23	AS5051AN WXMi LINPUSRU 5 UMAC 1*512/60/ 6L/ 5R_bg_0.3 C_AN	ATMK 36	N14.1 WXGA	SO512 MBII5	N	N60G B5.4K	NSM8 X	ABT_ BRM4 318BG	N	N
AS5051AWX Mi	EMEA	Middle East	LX.AV 305.04 4	AS5051AW XMi XPHAR8 UMAC 1*512/60/ BT/6L/5R/ CB_bg_0.3 C_AN	ATMK 36	N14.1 WXGA G	SO512 MBII5	N	N60G B5.4K	NSM8 X	ABT_ BRM4 318BG	FOX_ BRM_ 2.0	N
AS5051AWX Mi	EMEA	Eastern Europe	LX.AV 30J.05 7	AS5051AW XMi MCEPL7 UMAC 1*512/100/ BT/6L/ 5R_bg_VP _0.3C_AN	ATMK 36	N14.1 WXGA	SO512 MBII6	N	N100 GB5.4 K	NSM8 X	ABT_ BRM4 318BG	FOX_ BRM_ 2.0	BT VoIP PCMC IA
AS5051AWX Mi	EMEA	Russia	LX.AV 305.04 5	AS5051AW XMi XPHRU1 UMAC 1*512/100/ BT/6L/ 5R_bg_VP _0.3C_AN	ATMK 36	N14.1 WXGA	SO512 MBII6	N	N100 GB5.4 K	NSM8 X	ABT_ BRM4 318BG	FOX_ BRM_ 2.0	BT VoIP PCMC IA
AS5052WXM i	TWN	GCTWN	LX.AV 30J.05 8	AS5052WXM i MCETC9 UMAC 1*512/120/ BT/6L/5R/ CB_bg_0.3 C_AN	ATTL5 0	N14.1 WXGA G	SO512 MBII5	N	N120 GB5.4 K	NSM8 X	ABT_ BRM4 318BG	FOX_ BRM_ 2.0	N
AS5052WXM i	TWN	GCTWN	LX.AV 305.04 6	AS5052WXM i XPHTC1 UMAC 1*512/120/ BT/6L/5R/ CB_bg_0.3 C_AN	ATTL5 0	N14.1 WXGA G	SO512 MBII5	N	N120 GB5.4 K	NSM8 X	ABT_ ATH54 13BG	FOX_ BRM_ 2.0	N
AS5051AWX Mi	EMEA	Switzerland	LX.AV 30J.05 9	AS5051AW XMi MCESW8 UMAC 2*512/120/ BT/6L/5R/ CB_bg_0.3 C_AN	ATMK 36	N14.1 WXGA G	SO512 MBII5	SO512 MBII5	N120 GB5.4 K	NSM8 X	ABT_ BRM4 318BG	FOX_ BRM_ 2.0	N

Model	RO	Country	Acer Part no	Description	CPU	LCD	DIMM 1	DIMM 2	HDD 1 (GB)	ODD	Wireless LAN	Bluetooth	VOIP Phone
AS5051AWX Mi	EMEA	Switzerland	LX.AV 30J.060	AS5051AW XMi MCEW8 UMAC 2*512/120/6L/5R/CB_bg_0.3 C_AN	ATMK 36	N14.1 WXGAG	SO512 MBII5	SO512 MBII5	N120 GB5.4 K	NSM8 X	ABT_BRM4 318BG	N	N
AS5051AWX Mi	EMEA	Portugal	LX.AV 30J.061	AS5051AW XMi MCEPT6 UMAC 2*512/120/6L/5R_bg_0.3 C_AN	ATMK 36	N14.1 WXGAG	SO512 MBII5	SO512 MBII5	N120 GB5.4 K	NSM8 X	ABT_BRM4 318BG	N	N
AS5051AWX Mi	EMEA	Spain	LX.AV 30J.062	AS5051AW XMi MCEESJ UMAC 2*512/120/6L/5R_bg_0.3 C_AN	ATMK 36	N14.1 WXGAG	SO512 MBII5	SO512 MBII5	N120 GB5.4 K	NSM8 X	ABT_BRM4 318BG	N	N
AS5051AWX Mi	EMEA	Germany	LX.AV 30J.064	AS5051AW XMi MCEDEA UMAC 2*512/120/6L/5R_bg_0.3 C_AN	ATMK 36	N14.1 WXGAG	SO512 MBII5	SO512 MBII5	N120 GB5.4 K	NSM8 X	ABT_BRM4 318BG	N	N
AS5051AWX Mi	EMEA	Germany	LX.AV 30J.065	AS5051AW XMi MCEDEB UMAC 2*512/120/6L/5R_bg_0.3 C_AN	ATMK 36	N14.1 WXGAG	SO512 MBII5	SO512 MBII5	N120 GB5.4 K	NSM8 X	ABT_BRM4 318BG	N	N
AS5051AWX Mi	EMEA	Middle East	LX.AV 30J.070	AS5051AW XMi MCEAR1 UMAC 2*512/120/6L/5R_bg_0.3 C_AN	ATMK 36	N14.1 WXGAG	SO512 MBII5	SO512 MBII5	N120 GB5.4 K	NSM8 X	ABT_BRM4 318BG	N	N
AS5051AWX Mi	EMEA	Middle East	LX.AV 30J.084	AS5051AW XMi MCEAR2 UMAC 2*512/120/6L/5R_bg_0.3 C_AN	ATMK 36	N14.1 WXGAG	SO512 MBII5	SO512 MBII5	N120 GB5.4 K	NSM8 X	ABT_BRM4 318BG	N	N
AS5051AWX Mi	EMEA	Belgium	LX.AV 30J.066	AS5051AW XMi MCEBE6 UMAC 2*512/120/6L/5R_bg_0.3 C_AN	ATMK 36	N14.1 WXGAG	SO512 MBII5	SO512 MBII5	N120 GB5.4 K	NSM8 X	ABT_BRM4 318BG	N	N
AS5051AWX Mi	EMEA	Eastern Europe	LX.AV 30J.079	AS5051AW XMi MCECS5 UMAC 2*512/120/6L/5R_bg_0.3 C_AN	ATMK 36	N14.1 WXGAG	SO512 MBII5	SO512 MBII5	N120 GB5.4 K	NSM8 X	ABT_BRM4 318BG	N	N

Model	RO	Country	Acer Part no	Description	CPU	LCD	DIMM 1	DIMM 2	HDD 1 (GB)	ODD	Wireless LAN	Bluetooth	VOIP Phone
AS5051AWX Mi	EMEA	Holland	LX.AV 30J.069	AS5051AW XMi MCENL6 UMAC 2*512/120/6L/ 5R_bg_0.3 C_AN	ATMK 36	N14.1 WXGA	SO512 MBII5	SO512 MBII5	N120 GB5.4 K	NSM8 X	ABT_BRM4 318BG	N	N
AS5051AWX Mi	EMEA	Italy	LX.AV 30J.071	AS5051AW XMi MCEIT7 UMAC 2*512/120/6L/ 5R_bg_0.3 C_AN	ATMK 36	N14.1 WXGA	SO512 MBII5	SO512 MBII5	N120 GB5.4 K	NSM8 X	ABT_BRM4 318BG	N	N
AS5051AWX Mi	EMEA	Denmark	LX.AV 30J.074	AS5051AW XMi MCEDK6 UMAC 2*512/120/6L/ 5R_bg_0.3 C_AN	ATMK 36	N14.1 WXGA	SO512 MBII5	SO512 MBII5	N120 GB5.4 K	NSM8 X	ABT_BRM4 318BG	N	N
AS5051AWX Mi	EMEA	France	LX.AV 30J.063	AS5051AW XMi MCEFRF UMAC 2*512/120/6L/ 5R_bg_0.3 C_AN	ATMK 36	N14.1 WXGA	SO512 MBII5	SO512 MBII5	N120 GB5.4 K	NSM8 X	ABT_BRM4 318BG	N	N
AS5051AWX Mi	EMEA	Norway	LX.AV 30J.073	AS5051AW XMi MCENO5 UMAC 1*512/80/6L/ 5R_bg_0.3 C_AN	ATMK 36	N14.1 WXGA	SO512 MBII6	N	N80G B5.4K	NSM8 X	ABT_BRM4 318BG	N	N
AS5051AWX Mi	EMEA	Norway	LX.AV 30J.075	AS5051AW XMi MCENO5 UMAC 2*512/120/6L/ 5R_bg_0.3 C_AN	ATMK 36	N14.1 WXGA	SO512 MBII5	SO512 MBII5	N120 GB5.4 K	NSM8 X	ABT_BRM4 318BG	N	N
AS5051AWX Mi	EMEA	Russia	LX.AV 30J.080	AS5051AW XMi MCERU9 UMAC 2*512/120/6L/ 5R_bg_0.3 C_AN	ATMK 36	N14.1 WXGA	SO512 MBII5	SO512 MBII5	N120 GB5.4 K	NSM8 X	ABT_BRM4 318BG	N	N
AS5051AWX Mi	EMEA	Slovenia/Croatia	LX.AV 30J.085	AS5051AW XMi MCES11 UMAC 2*512/120/6L/ 5R_bg_0.3 C_AN	ATMK 36	N14.1 WXGA	SO512 MBII5	SO512 MBII5	N120 GB5.4 K	NSM8 X	ABT_BRM4 318BG	N	N
AS5051AWX Mi	EMEA	Switzerland	LX.AV 30J.086	AS5051AW XMi MCESW8 UMAC 2*512/120/6L/ 5R_bg_0.3 C_AN	ATMK 36	N14.1 WXGA	SO512 MBII5	SO512 MBII5	N120 GB5.4 K	NSM8 X	ABT_BRM4 318BG	N	N

Model	RO	Country	Acer Part no	Description	CPU	LCD	DIMM 1	DIMM 2	HDD 1 (GB)	ODD	Wireless LAN	Bluetooth	VOIP Phone
AS5051AWX Mi	EMEA	Eastern Europe	LX.AV 30J.068	AS5051AW XMi MCEPL7 UMAC 2*512/120/6L/ 5R_bg_0.3 C_AN	ATMK 36	N14.1 WXGA	SO512 MBII5	SO512 MBII5	N120 GB5.4 K	NSM8 X	ABT_BRM4 318BG	N	N
AS5051AWX Mi	EMEA	Sweden/Finland	LX.AV 30J.067	AS5051AW XMi MCESV5 UMAC 2*512/120/6L/ 5R_bg_0.3 C_AN	ATMK 36	N14.1 WXGA	SO512 MBII5	SO512 MBII5	N120 GB5.4 K	NSM8 X	ABT_BRM4 318BG	N	N
AS5051AWX Mi	EMEA	UK	LX.AV 30J.081	AS5051AW XMi MCEUUK1 1U UMAC 2*512/120/6L/ 5R_bg_0.3 C_AN	ATMK 36	N14.1 WXGA	SO512 MBII5	SO512 MBII5	N120 GB5.4 K	NSM8 X	ABT_BRM4 318BG	N	N
AS5051AWX Mi	EMEA	UK	LX.AV 30J.087	AS5051AW XMi MCEUK5 UMAC 2*512/120/6L/ 5R_bg_0.3 C_AN	ATMK 36	N14.1 WXGA	SO512 MBII5	SO512 MBII5	N120 GB5.4 K	NSM8 X	ABT_BRM4 318BG	N	N
AS5051AWX Mi	EMEA	Turkey	LX.AV 30J.072	AS5051AW XMi MCETR5 UMAC 2*512/120/6L/ 5R_bg_0.3 C_AN	ATMK 36	N14.1 WXGA	SO512 MBII5	SO512 MBII5	N120 GB5.4 K	NSM8 X	ABT_BRM4 318BG	N	N
AS5051AWX Mi	EMEA	Italy	LX.AV 30J.076	AS5051AW XMi MCEWIT11 W UMAC 2*512/120/6L/ 5R_bg_0.3 C_AN	ATMK 36	N14.1 WXGA	SO512 MBII5	SO512 MBII5	N120 GB5.4 K	NSM8 X	ABT_BRM4 318BG	N	N
AS5051AWX Mi	EMEA	UK	LX.AV 30J.088	AS5051AW XMi MCEUK6 UMAC 2*512/120/6L/ 5R_bg_0.3 C_AN	ATMK 36	N14.1 WXGA	SO512 MBII5	SO512 MBII5	N120 GB5.4 K	NSM8 X	ABT_BRM4 318BG	N	N
AS5051AWX Mi	EMEA	France	LX.AV 30J.077	AS5051AW XMi MCEWFR1 1W UMAC 2*512/120/6L/ 5R_bg_0.3 C_AN	ATMK 36	N14.1 WXGA	SO512 MBII5	SO512 MBII5	N120 GB5.4 K	NSM8 X	ABT_BRM4 318BG	N	N
AS5051AWX Mi	EMEA	Germany	LX.AV 30J.078	AS5051AW XMi MCEWDE1 1W UMAC 2*512/120/6L/ 5R_bg_0.3 C_AN	ATMK 36	N14.1 WXGA	SO512 MBII5	SO512 MBII5	N120 GB5.4 K	NSM8 X	ABT_BRM4 318BG	N	N

Model	RO	Country	Acer Part no	Description	CPU	LCD	DIMM 1	DIMM 2	HDD 1 (GB)	ODD	Wireless LAN	Bluetooth	VOIP Phone
AS5051AWX Mi	EMEA	Germany	LX.AV 305.057	AS5051AW XMi XPHDE7 UMAC 2*512/120/6L/ 5R_bg_0.3 C_AN	ATMK 36	N14.1 WXGA	SO512 MBII5	SO512 MBII5	N120 GB5.4 K	NSM8 X	ABT_BRM4 318BG	N	N
AS5051AWX Mi	EMEA	Middle East	LX.AV 305.061	AS5051AW XMi XPHAR1 UMAC 2*512/120/6L/ 5R_bg_0.3 C_AN	ATMK 36	N14.1 WXGA	SO512 MBII5	SO512 MBII5	N120 GB5.4 K	NSM8 X	ABT_BRM4 318BG	N	N
AS5051AWX Mi	EMEA	Denmark	LX.AV 305.047	AS5051AW XMi XPHDK1 UMAC 2*512/120/6L/ 5R_bg_0.3 C_AN	ATMK 36	N14.1 WXGA	SO512 MBII5	SO512 MBII5	N120 GB5.4 K	NSM8 X	ABT_BRM4 318BG	N	N
AS5051AWX Mi	EMEA	Belgium	LX.AV 305.056	AS5051AW XMi XPHBE1 UMAC 2*512/120/6L/ 5R_bg_0.3 C_AN	ATMK 36	N14.1 WXGA	SO512 MBII5	SO512 MBII5	N120 GB5.4 K	NSM8 X	ABT_BRM4 318BG	N	N
AS5051AWX Mi	EMEA	Eastern Europe	LX.AV 305.052	AS5051AW XMi XPHCS2 UMAC 2*512/120/6L/ 5R_bg_0.3 C_AN	ATMK 36	N14.1 WXGA	SO512 MBII5	SO512 MBII5	N120 GB5.4 K	NSM8 X	ABT_BRM4 318BG	N	N
AS5051AWX Mi	EMEA	UK	LX.AV 30J.083	AS5051AW XMi MCEWUK1 1W UMAC 2*512/120/6L/ 5R_bg_0.3 C_AN	ATMK 36	N14.1 WXGA	SO512 MBII5	SO512 MBII5	N120 GB5.4 K	NSM8 X	ABT_BRM4 318BG	N	N
AS5051AWX Mi	EMEA	UK	LX.AV 30J.082	AS5051AW XMi MCEWUK2 1W UMAC 2*512/120/6L/ 5R_bg_0.3 C_AN	ATMK 36	N14.1 WXGA	SO512 MBII5	SO512 MBII5	N120 GB5.4 K	NSM8 X	ABT_BRM4 318BG	N	N
AS5051AWX Mi	EMEA	Eastern Europe	LX.AV 305.051	AS5051AW XMi XPHHU6 UMAC 2*512/120/6L/ 5R_bg_0.3 C_AN	ATMK 36	N14.1 WXGA	SO512 MBII5	SO512 MBII5	N120 GB5.4 K	NSM8 X	ABT_BRM4 318BG	N	N
AS5051AWX Mi	EMEA	Spain	LX.AV 305.059	AS5051AW XMi XPHESA UMAC 2*512/120/6L/ 5R_bg_0.3 C_AN	ATMK 36	N14.1 WXGA	SO512 MBII5	SO512 MBII5	N120 GB5.4 K	NSM8 X	ABT_BRM4 318BG	N	N

Model	RO	Country	Acer Part no	Description	CPU	LCD	DIMM 1	DIMM 2	HDD 1 (GB)	ODD	Wireless LAN	Bluetooth	VOIP Phone
AS5051AWX Mi	EMEA	Greece	LX.AV 305.054	AS5051AW XMi XPHEL1 UMAC 2*512/120/6L/ 5R_bg_0.3 C_AN	ATMK 36	N14.1 WXGA	SO512 MBII5	SO512 MBII5	N120 GB5.4 K	NSM8 X	ABT_BRM4 318BG	N	N
AS5051AWX Mi	EMEA	Israel	LX.AV 305.069	AS5051AW XMi XPHIS1 UMAC 2*512/120/6L/ 5R_bg_0.3 C_AN	ATMK 36	N14.1 WXGA	SO512 MBII5	SO512 MBII5	N120 GB5.4 K	NSM8 X	ABT_BRM4 318BG	N	N
AS5051AWX Mi	EMEA	France	LX.AV 305.048	AS5051AW XMi XPHFRA UMAC 2*512/120/6L/ 5R_bg_0.3 C_AN	ATMK 36	N14.1 WXGA	SO512 MBII5	SO512 MBII5	N120 GB5.4 K	NSM8 X	ABT_BRM4 318BG	N	N
AS5051AWX Mi	EMEA	Italy	LX.AV 305.055	AS5051AW XMi XPHIT1 UMAC 2*512/120/6L/ 5R_bg_0.3 C_AN	ATMK 36	N14.1 WXGA	SO512 MBII5	SO512 MBII5	N120 GB5.4 K	NSM8 X	ABT_BRM4 318BG	N	N
AS5051AWX Mi	EMEA	Eastern Europe	LX.AV 305.053	AS5051AW XMi XPHPL6 UMAC 2*512/120/6L/ 5R_bg_0.3 C_AN	ATMK 36	N14.1 WXGA	SO512 MBII5	SO512 MBII5	N120 GB5.4 K	NSM8 X	ABT_BRM4 318BG	N	N
AS5051AWX Mi	EMEA	Holland	LX.AV 305.067	AS5051AW XMi XPHNL1 UMAC 2*512/120/6L/ 5R_bg_0.3 C_AN	ATMK 36	N14.1 WXGA	SO512 MBII5	SO512 MBII5	N120 GB5.4 K	NSM8 X	ABT_BRM4 318BG	N	N
AS5051AWX Mi	AAP	Malaysia	LX.AV 305.066	AS5051AW XMi XPHMA2 UMAC 1*512/80/6L/5R/ CB_bg_0.3 C_AN	ATMK 36	N14.1 WXGA G	SO512 MBII5	N	N80G B5.4K	NSM8 X	ABT_ATH54 13BG	N	N
AS5051AWX Mi	EMEA	Norway	LX.AV 305.058	AS5051AW XMi XPHNO1 UMAC 2*512/120/6L/ 5R_bg_0.3 C_AN	ATMK 36	N14.1 WXGA	SO512 MBII5	SO512 MBII5	N120 GB5.4 K	NSM8 X	ABT_BRM4 318BG	N	N
AS5051AWX Mi	EMEA	South Africa	LX.AV 305.062	AS5051AW XMi XPHSA1 UMAC 2*512/120/6L/ 5R_bg_0.3 C_AN	ATMK 36	N14.1 WXGA	SO512 MBII5	SO512 MBII5	N120 GB5.4 K	NSM8 X	ABT_BRM4 318BG	N	N

Model	RO	Country	Acer Part no	Description	CPU	LCD	DIMM 1	DIMM 2	HDD 1 (GB)	ODD	Wireless LAN	Bluetooth	VOIP Phone
AS5051AWX Mi	EMEA	Russia	LX.AV 305.049	AS5051AWXMi XPHRU2 UMAC 2*512/120/6L/ 5R_bg_0.3 C_AN	ATMK 36	N14.1 WXGA	SO512 MBII5	SO512 MBII5	N120 GB5.4 K	NSM8 X	ABT_BRM4 318BG	N	N
AS5051AWX Mi	EMEA	Sweden/Finland	LX.AV 305.050	AS5051AWXMi XPHSV1 UMAC 2*512/120/6L/ 5R_bg_0.3 C_AN	ATMK 36	N14.1 WXGA	SO512 MBII5	SO512 MBII5	N120 GB5.4 K	NSM8 X	ABT_BRM4 318BG	N	N
AS5051AWX Mi	EMEA	Slovenia/Croatia	LX.AV 305.063	AS5051AWXMi XPHSLO2 UMAC 2*512/120/6L/ 5R_bg_0.3 C_AN	ATMK 36	N14.1 WXGA	SO512 MBII5	SO512 MBII5	N120 GB5.4 K	NSM8 X	ABT_BRM4 318BG	N	N
AS5051AWX Mi	EMEA	Portugal	LX.AV 305.068	AS5051AWXMi XPHPT1 UMAC 2*512/120/6L/ 5R_bg_0.3 C_AN	ATMK 36	N14.1 WXGA	SO512 MBII5	SO512 MBII5	N120 GB5.4 K	NSM8 X	ABT_BRM4 318BG	N	N
AS5051AWX Mi	EMEA	Switzerland	LX.AV 305.064	AS5051AWXMi XPHSW5 UMAC 2*512/120/6L/ 5R_bg_0.3 C_AN	ATMK 36	N14.1 WXGA	SO512 MBII5	SO512 MBII5	N120 GB5.4 K	NSM8 X	ABT_BRM4 318BG	N	N
AS5051AWX Mi	EMEA	UK	LX.AV 305.065	AS5051AWXMi XPHUK1 UMAC 2*512/120/6L/ 5R_bg_0.3 C_AN	ATMK 36	N14.1 WXGA	SO512 MBII5	SO512 MBII5	N120 GB5.4 K	NSM8 X	ABT_BRM4 318BG	N	N
AS5051AWX Mi	EMEA	Turkey	LX.AV 305.070	AS5051AWXMi XPHTR1 UMAC 2*512/120/6L/ 5R_bg_0.3 C_AN	ATMK 36	N14.1 WXGA	SO512 MBII5	SO512 MBII5	N120 GB5.4 K	NSM8 X	ABT_BRM4 318BG	N	N
AS5051ANWXMi	EMEA	Turkey	LX.AV 30C.025	AS5051ANWXMi LINPUSTR1 UMAC 1*512/60/6L/5R/ CB_bg_0.3 C_AN	ATMK 36	N14.1 WXGA G	SO512 MBII5	N	N60G B5.4K	NSM8 X	ABT_BRM4 318BG	N	N
AS5051AWX Mi	EMEA	Turkey	LX.AV 305.071	AS5051AWXMi XPHTR1 UMAC 1*512/60/6L/5R/ CB_bg_0.3 C_AN	ATMK 36	N14.1 WXGA G	SO512 MBII5	N	N60G B5.4K	NSM8 X	ABT_BRM4 318BG	N	N

Model	RO	Country	Acer Part no	Description	CPU	LCD	DIMM 1	DIMM 2	HDD 1 (GB)	ODD	Wireless LAN	Bluetooth	VOIP Phone
AS5052NWXMi	AAP	India	LX.AV30C.026	AS5052N WXMi LINPUSIL1 UMAC 1*512/80/ BT/6L/5R/ CB_bg_0.3 C_AN	ATTL50	N14.1 WXGAG	SO512 MBII5	N	N80GB5.4K	NSM8X	ABT_ATH5413BG	FOX_BRM_2.0	N

Test Compatible Components

This computer's compatibility is tested and verified by Acer's internal testing department. All of its system functions are tested under Windows® XP Home, Windows® XP Pro environment.

Refer to the following lists for components, adapter cards, and peripherals which have passed these tests. Regarding configuration, combination and test procedures, please refer to the Aspire 5930/5930Z/5730Z series Compatibility Test Report released by the Acer Mobile System Testing Department.

Microsoft® Windows® Vista Environment Test

Item	Specification
CRT Port Test	
CRT Monitor	Acer 211c 21", ViewSonic G220F, ViewSonic PF790 19"
LCD Monitor	Acer FP751 17" TFT LCD, Acer AL1521, Acer AL1721, ViewSonic VD201b, Westinghouse W37G, HP LP2065, HP S9500
Projector	Dell 3300MP
USB Port Test	
USB Keyboard/Mouse	Microsoft Natural Keyboard Pro Dell USB Keyboard Logicool USB Mouse (OWCM-USB) Logitech USB Wheel Mouse Logitech First Wheel Mouse Dell by Logitech Dell Internet Navigator Keyboard Dell Smart Card Keyboard HP USB Optical Austin Mouse Belkin Miniglow Optical USB Mouse HP USB Optical Mouse (RB129AA)
USB Speaker/Joystick	Aiwa Multimedia Digital Speaker (SC-UC78) Panasonic USB Speaker EAB-MPC57USB
USB Storage Drive	Iomega USB Zip 250MB Transcend 80G HDD Plextor DVD+R/RW LG DVD+R/RW Sony DVD+R/RW
USB Camera	Intel Easy PC Camera (A20953-001) Orange Micro USB 2.0 Web Cam
USB HUB and Others	A TEN UH-204 IOGEAR 4-Port Hub Corega CG-WLUSBST11
USB Printer/Scanner	HP 450WBT Deskjet Printer
USB Flash Drive	Sony Memory Key 128MB Sony Micro Vault Pro USD-5G IBM 128MB Memory Key IBM 512MB Memory Key Apacer Handy Drive Apacer The USB Flash Drive 256MB
USB ODD	Logitec CDRW+DVDROM combo LG DVD+R/RW Sony DVD+R/RW
1394 Camera	Sony DV-TRV10
Access Point 802.11a	Intel Pro/Wireless 5000 NetGear HE 102
Access Point 802.11g	D-Link Building Networks People WiFi Certified a/b/g Wireless 108AG
Access Point 802.11n	Belkin N1MIMO Wireless Router High Performance wireless 802.11n
Bluetooth Device	Sony Ericsson Wireless Headset Sony Ericsson T610 X Bridge Bluetooth Access Point BT300

Item	Specification
PCMCIA Test	
LAN/Modem Card	TDK CardBus Ethernet 10/100 32-Bit CBE-10/100BTX
Storage Card	Hitachi Microdrive 4G
1394 Card	Buffalo 1394 Interface Cardbus (IFC-ILCB/DV)
USB2.0 Card	IBM EtherJet CardBus Adapter 10/100
Wireless Lan Card (Not recommended for wireless ready model)	Cisco Wireless LAN Card 802.11a NETGEAR Wireless LAN card 802.11a
ISDN Card	Toshiba Type B for Bluetooth 128K ISDN Card
GPRS Card	Vodafone QL1ACC-21581 3G/GPRS card Sony Ericsson GC83 GPRS card Sony Ericsson GC89 GPRS card
ExpressCard Test	
Express Card	Abcom 5-in-1 Adapter ExpressCard Reader Abcom GigaLan ExpressCard Sunix ECF2400 2 Ports 1394A ExpressCard
Memory Card Test (SD/MS/MMC/SM/CF/Microdrive/XD)	
SD Card	Apacer 128/256MB SanDisk 256MB Apacer 2GB (150x Hi-Speed) KINGMAX 1GB (66x Hi-Speed) SanDisk 1GB RiDATA 4GB SD PRO Memory Card
MS Card	Sony 512 MS PRO Lexar 512MB MS PRO Lexar 1GB MS PRO Sony 2GB MS PRO
MMC Card	SanDisk 32MB Transcend 64/128MB Transcend 256MB SanDisk RS-MMC 128MB PQI RS-MMC 256MB Transcend 512MB A-DATA Turbo 200X 2GB MMC Card
XD Card	Apacer 256/512MB SanDisk 2GB Olympus 512MB
CF Card	Apacer 256/512 SanDisk 2GB

Online Support Information

This section describes online technical support services available to help you repair your Acer Systems.

If you are a distributor, dealer, ASP or TPM, please refer your technical queries to your local Acer branch office. Acer Branch Offices and Regional Business Units may access our website. However some information sources will require a user i.d. and password. These can be obtained directly from Acer CSD Taiwan.

Acer's Website offers you convenient and valuable support resources whenever you need them.

In the Technical Information section you can download information on all of Acer's Notebook, Desktop and Server models including:

- Service guides for all models
- User's manuals
- Training materials
- Bios updates
- Software utilities
- Spare parts lists
- TABs (Technical Announcement Bulletin)

For these purposes, we have included an Acrobat File to facilitate the problem-free downloading of our technical material.

Also contained on this website are:

- Detailed information on Acer's International Traveller's Warranty (ITW)
- Returned material authorization procedures
- An overview of all the support services we offer, accompanied by a list of telephone, fax and email contacts for all your technical queries.

We are always looking for ways to optimize and improve our services, so if you have any suggestions or comments, please do not hesitate to communicate these to us.

A

AFLASH Utility 51
Antennas 108
Audio 35

B

Battery Pack 60
BIOS 31
 vendor 31
 Version 31
BIOS Utility 39–51
 Navigating 40
 Onboard Device Configuration 45
 Security 43, 44
 System Security 50
Board Layout
 Top View 131
brightness
 hotkeys 17

C

caps lock
 on indicator 12
computer
 on indicator 7, 12
CPU 77
CPU Fan True Value Table 31

D

DIMM Module 63
Display 4
display
 hotkeys 17

E

Error Symptom-to-Spare Part Index 116
Euro 18
External CD-ROM Drive Check 112
External Module Disassembly
 Flowchart 59

F

Features 1
Fingerprint Board 91
Flash Utility 51
fpc cable 106
FRU (Field Replaceable Unit) List 135

H

Hard disk 33
Hard Disk Drive Module 66
HDD 33
Hibernation mode
 hotkey 17
Hot Keys 15

I

Indicators 12
Intermittent Problems 129

J

Jumper and Connector Locations 131
 Top View 131

K

Keyboard 35, 72
Keyboard or Auxiliary Input Device Check
 112

L

Launch Board 90
LCD Bezel 103
LCD Brackets 107
LCD Module Disassembly
 Flowchart 102
LCD with the Brackets 104
lower cover 62

M

Main Unit Disassembly
 Flowchart 71
Mainboard 94

media access
 on indicator 12
Memory Check 113
Model Definition 146
Modem Board 65

N

Notebook Manager
 hotkey 17
num lock
 on indicator 12

O

Online Support Information 173

P

Panel 5
 Bottom 11
 left 5
PC Card 12
Power System Check 113
 Battery Pack 115
 Power Adapter 114
Processor 31

S

Screw List 58
speakers
 hotkey 17
System
 Block Diagram 4
System Check Procedures 112
System Memory 31
System Utilities 39

T

Test Compatible Components 169
Top 131
touchpad
 hotkey 17
 using 13
Touchpad Check 115
Troubleshooting 111

U

Undetermined Problems 130
utility
 BIOS 39–51

V

view
 left 8
 rear 10
 right 8

W

Windows 2000 Environment Test 170
WLAN Board 63